

# General Specifications

Toggles

Rockers  
B

Pushbuttons

Illuminated PB

Programmable

Keylocks

Rotaries

Slides

Tactiles

Tilt

Touch

Indicators

Accessories

Supplement

## Electrical Capacity (Resistive Load)

**Power Level (silver):** 6A @ 125V AC or 3A @ 250V AC;  
4A @ 30V DC (On-On circuit) & 3A @ 30V DC (all other circuits)

**Logic Level (gold):** 0.4VA maximum @ 28V AC/DC maximum  
(Applicable Range 0.1mA ~ 0.1A @ 20mV ~ 28V)

**Logic/Power Level (gold over silver):** Combines silver & gold ratings  
Note: Find additional explanation of dual rating & operating range in Supplement section.

## Other Ratings

**Contact Resistance:** 10 milliohms maximum for silver; 20 milliohms maximum for gold

**Insulation Resistance:** 1,000 megohms minimum @ 500V DC

**Dielectric Strength:** 1,000V AC minimum between contacts for 1 minute minimum;  
1,500V AC minimum between contacts & case for 1 minute minimum

**Mechanical Life:** 50,000 operations minimum

**Electrical Life:** 25,000 operations minimum for silver; 50,000 operations minimum for gold

**Contact Timing:** Nonshorting (break-before-make)

**Angle of Throw:** 26°

## Materials & Finishes

**Lever:** Brass with nickel plating

**Actuator Clip:** Polyacetal

**Support Bracket:** Brass with tin plating

**Bushing/Housing:** Glass fiber reinforced polyamide (UL94V-0)

**Sealing Ring:** Nitrile butadiene rubber

**Base:** Glass fiber reinforced polyamide (UL94V-0)

**Movable Contacts:** Silver alloy with silver plating (code W); copper or phosphor bronze with gold plating (code G);  
or silver alloy with gold plating (code A)

**Stationary Contacts:** Silver alloy with silver plating (code W); copper or brass with gold plating (code G);  
or silver alloy with gold plating (code A)

**Terminals:** Copper or brass with silver or gold plating

## Environmental Data

**Operating Temp Range:** -30°C through +85°C (-22°F through +185°F)

**Humidity:** 90 ~ 95% humidity for 96 hours @ 40°C (104°F)

**Vibration:** 10 ~ 55Hz with peak-to-peak amplitude of 1.5mm traversing the frequency range & returning  
in 1 minute; 3 right angled directions for 2 hours

**Shock:** 50G (490m/s<sup>2</sup>) acceleration (tested in 6 right angled directions, with 5 shocks in each direction)

## PCB Processing

**Soldering:** Wave Soldering Recommended: See Profile B in Supplement section.

Manual Soldering: See Profile B in Supplement section.

**Cleaning:** Automated cleaning. See Cleaning specifications in Supplement section.

## Standards & Certifications

**Flammability Standards:** UL94V-0 rated bushing/housing & base

**UL:** File No. E44145 - Recognized only when ordered with marking on switch.

Add "/U" or "/CUL" before dash in part number to order UL recognized switch.

All models recognized at 6A @ 125V AC, 3A @ 250V AC, & 4A @ 30V DC or 0.4A @ 28V DC.

**CSA:** File No. 023535\_0\_000 - Certified only when ordered with marking on switch.

Add "/C" before dash in part number to order CSA certified switch.

All models certified at 6A @ 125V AC, 3A @ 250V AC, & 4A @ 30V DC.

# Distinctive Characteristics

Antijamming design protects against mechanism damage from downward force on the actuator.

O-ring surrounding top of lever prevents liquids from reaching switch mechanism.

Ultrasonic welding of upper and lower housing seals out contaminants and allows automated soldering and cleaning.

Terminals are epoxy sealed to prevent entry of flux, solvents, and other contaminants.

Bracketed models have crimped bracket legs to ensure secure PC mounting and prevent dislodging during automated soldering.

Logic level and power capabilities are available to suit varying applications.

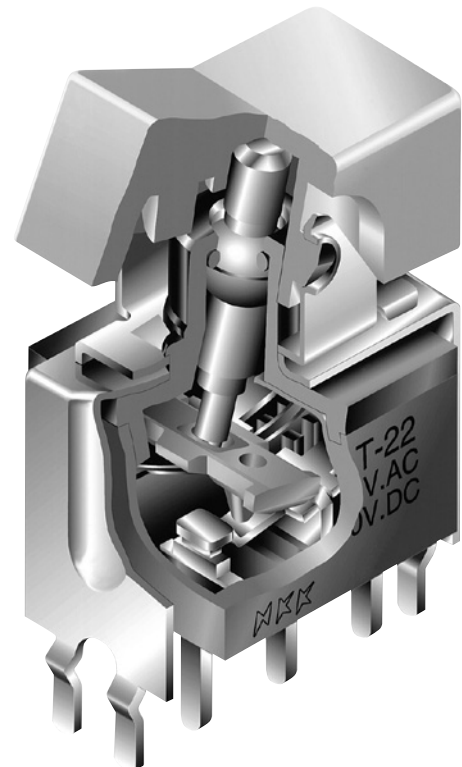

Actual Size



- Toggle
- B** Rockers
- Pushbuttons
- Illuminated PB
- Programmable
- Keylocks
- Rotaries
- Slides
- Tactiles
- Tilt
- Touch
- Indicators
- Accessories
- Supplement

## TYPICAL SWITCH ORDERING EXAMPLE



### IMPORTANT:



Switches are supplied without UL, cULus & CSA marking unless specified. **UL, cULus & CSA recognized only when ordered with marking on the switch.** Specific models, ratings, & ordering instructions are noted on General Specifications page.

### DESCRIPTION FOR TYPICAL ORDERING EXAMPLE

#### M2T22TXG41-DC

Mounting Frame for Actuators with Straight or Angle PC Mount

.365" (9.27mm) Wide Red Rocker



DPDT ON-NONE-ON Circuit

.150" (3.81mm) Vertical Terminals

Gold Contacts with 0.4VA Rating

Toggles  
Rockers  
Pushbuttons  
Illuminated PB  
Programmable  
Keylocks  
Rotaries  
Slides  
Tactiles  
Tilt  
Touch  
Indicators  
Accessories  
Supplement

## POLES & CIRCUITS

Pole	Model	Rocker Position ( ) = Momentary			Connected Terminals			Throw & Schematics
		Down	Center	Up	Down	Center	Up	
SP	M2T12 M2T13 M2T15 M2T18 M2T19	ON ON ON (ON) ON	NONE OFF NONE OFF OFF	ON ON (ON) (ON) (ON)	2-3	OPEN	2-1	Note: Terminal numbers are not actually on the switch.  SPDT 
DP	M2T22 M2T23 M2T25 M2T28 M2T29	ON ON ON (ON) ON	NONE OFF NONE OFF OFF	ON ON (ON) (ON) (ON)	2-3 5-6	OPEN	2-1 5-4	DPDT 

## MOUNTING FRAME

**TX**

Mounting Frame for Rockers or Paddles with Straight or Angle PC Terminals

Straight PC Mounting



Right Angle PC Mounting

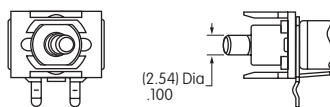

Vertical PC Mounting

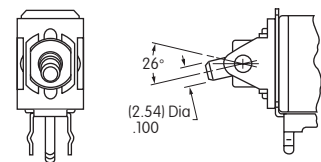

Actuators & Panel Cutouts



AT4148



AT4149



AT4150



AT4151

## CONTACT MATERIALS & RATINGS

**W**

Silver over Silver

Power Level

6A @ 125V AC & 3A @ 250V AC

**G**

Gold over Brass or Copper

Logic Level

0.4VA maximum @ 28V AC/DC maximum

Complete explanation of operating range in Supplement section.

**A**

Gold over Silver

Power Level  
or Logic Level

6A @ 125V AC  
or 0.4VA maximum @ 28V AC/DC maximum

Note: This dual rated option is suitable when two or more identical switches are used in logic and in power circuits within the same application. See Supplement section for complete explanation of dual rating and operating range.

Toggle

Rockers **B**

Pushbuttons

Illuminated PB

Programmable

Keylocks

Rotaries

Slides

Tactiles

Tilt

Touch

Indicators

Accessories

Supplement

## PC TERMINALS

**13** Straight with  
.460" (11.7mm)  
Bracket



**30** .150" (3.81mm)  
Right Angle



**41** .150" (3.81mm)  
Vertical



## ROCKERS & PADDLES

**D** AT4148  
.365" (9.27mm) Wide Rocker

Material: Polyamide  
Finish: Matte

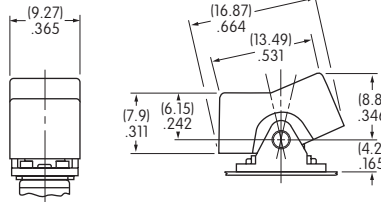

**E** AT4149  
.365" (9.27mm) Wide Paddle

Material: Polyamide  
Finish: Matte



**F** AT4150  
.450" (11.43mm) Wide Rocker

Material: Polyamide  
Finish: Matte



**G** AT4151  
.450" (11.43mm) Wide Paddle

Material: Polyamide  
Finish: Matte



Cap Colors Available:

**A** Black

**B** White

**C** Red

**E** Yellow

**F** Green

**G** Blue

**H** Gray

## TYPICAL SWITCH DIMENSIONS

Straight PC • Bracket

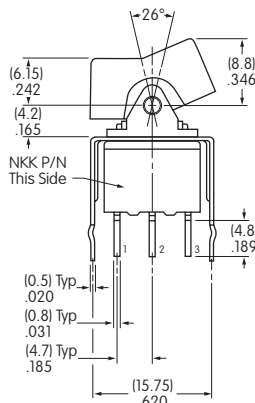

Single Pole

Double Pole

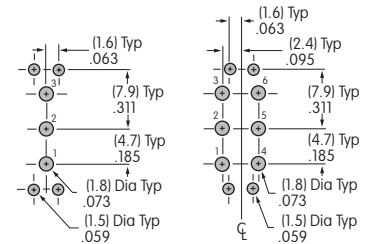
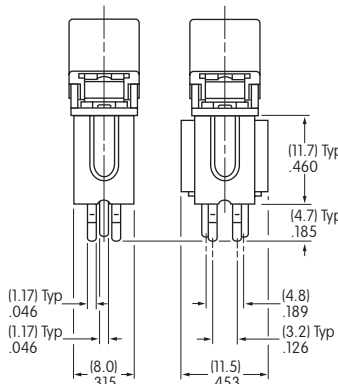

M212TXG13-DC

TYPICAL SWITCH DIMENSIONS

Single Pole

Right Angle PC

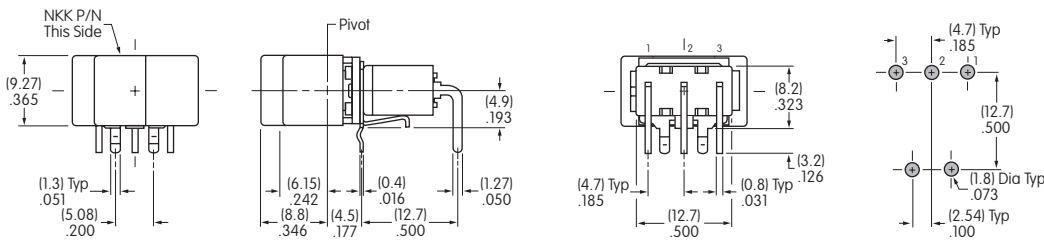

M2T12TXG30-DC

Double Pole

Right Angle PC



M2T22TXG30-DC

Single Pole

Vertical PC

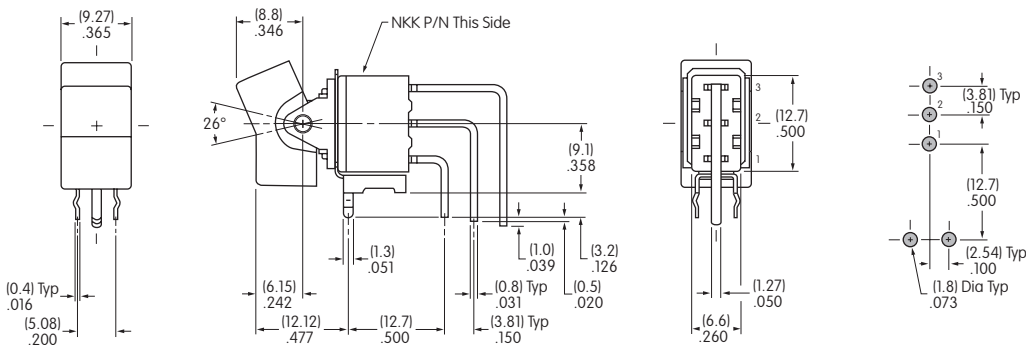

M2T12TXG41-DC

Double Pole

Vertical PC

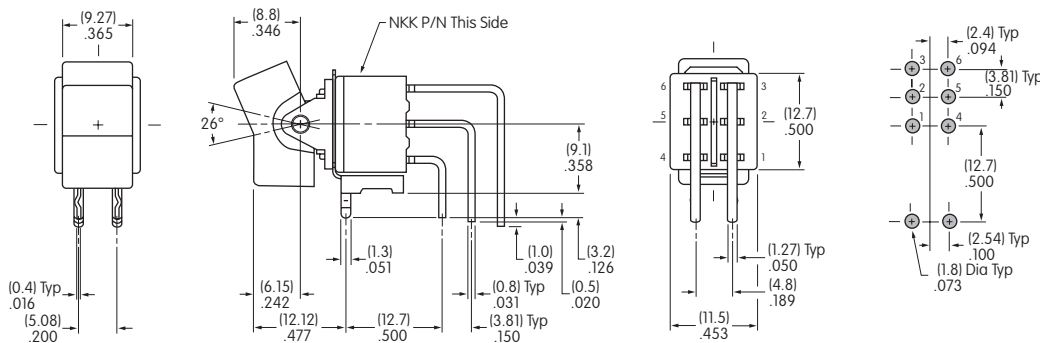

M2T22TXG41-DC

Toggle

**B** Rockers

Pushbuttons

Illuminated PB

Programmable

Keylocks

Rotaries

Slides

Tactiles

Tilt

Touch

Indicators

Accessories

Supplement

## LEGENDS

NKK Switches can provide custom legends for caps. Contact factory for more information.

### Suggested Printable Area for Cap



AT4148



AT4150

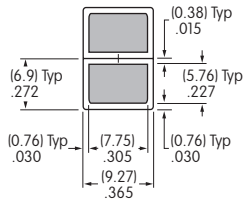

Shaded areas are printable areas.

### Recommended Print Method:

Pad Print

Epoxy based ink is recommended.









Компания «ЭлектроПласт» предлагает заключение долгосрочных отношений при поставках импортных электронных компонентов на взаимовыгодных условиях!

Наши преимущества:

- Оперативные поставки широкого спектра электронных компонентов отечественного и импортного производства напрямую от производителей и с крупнейших мировых складов;
- Поставка более 17-ти миллионов наименований электронных компонентов;
- Поставка сложных, дефицитных, либо снятых с производства позиций;
- Оперативные сроки поставки под заказ (от 5 рабочих дней);
- Экспресс доставка в любую точку России;
- Техническая поддержка проекта, помощь в подборе аналогов, поставка прототипов;
- Система менеджмента качества сертифицирована по Международному стандарту ISO 9001;
- Лицензия ФСБ на осуществление работ с использованием сведений, составляющих государственную тайну;
- Поставка специализированных компонентов (Xilinx, Altera, Analog Devices, Intersil, Interpoint, Microsemi, Aeroflex, Peregrine, Syfer, Eurofarad, Texas Instrument, Miteq, Cobham, E2V, MA-COM, Hittite, Mini-Circuits, General Dynamics и др.);

Помимо этого, одним из направлений компании «ЭлектроПласт» является направление «Источники питания». Мы предлагаем Вам помощь Конструкторского отдела:

- Подбор оптимального решения, техническое обоснование при выборе компонента;
- Подбор аналогов;
- Консультации по применению компонента;
- Поставка образцов и прототипов;
- Техническая поддержка проекта;
- Защита от снятия компонента с производства.



#### Как с нами связаться

**Телефон:** 8 (812) 309 58 32 (многоканальный)

**Факс:** 8 (812) 320-02-42

**Электронная почта:** [org@eplast1.ru](mailto:org@eplast1.ru)

**Адрес:** 198099, г. Санкт-Петербург, ул. Калинина, дом 2, корпус 4, литера А.