

SPECIFICATION

Part No.	:	WCM.01.0151W
Product Name:	:	2.4GHz Button Antenna
Features	:	Smallest External Wi-Fi/Bluetooth Antenna 2dBi~5dBi Peak Gain Dims: 19.8*14.3*16.4mm 2400MHz to 2500MHz Antenna Wi-Fi/Bluetooth 60%+ Efficiency RP SMA(M) Connector IP67 Housing Omnidirectional ROHS Compliant *Gain varies depending on ground-plane size



1. Introduction

The WCM.01w 2.4GHz antenna is the smallest RP-SMA(M) external antenna in the market, fitting into spaces other traditional monopole, dipole or rubber ducky antenna cannot go. A unique PIFA design ensures omnidirectional gain across 2.4GHz to 2.5GHz ensuring constant reception and transmission to make it a great antenna for 2.4GHz Wi-Fi and Bluetooth applications.

This antenna features greater than 60% efficiency when connected directly to the ground plane of the device.

Typical Applications

- Application Points
- Routers
- IoT M2M devices
- Smart Home applications

This antenna comes with an RP SMA(M) to be compatible with most Wi-Fi applications and routers in the market. The WCM.01 antenna housing is also IP67 water resistant. The antenna should be mounted on the edge of the main PCB ground-plane of the device. Due to its monopole design, relatively larger ground-planes will increase the efficiency and peak gain of the antenna.

The ideal position for the antenna to radiate is mounted clear of metal housings. Connector is customizable subject to minimum order quantities and possible NRE.

Contact your Taoglas regional sales office for more information.

2. Specification

ELECTRICAL				
Frequency (MHz)		2400	2450	2500
Efficiency (%)				
In free space		33.30	30.36	29.65
On the 10*10cm	Ground plane(center edge)	63.43	71.44	66.85
On the 10*10cm	Ground plane(off center edge)	55.85	68.43	61.73
On the 20*20cm	Ground plane(center edge)	64.20	71.40	63.97
On the 20*20cm	Ground plane(off center edge)	62.55	81.30	69.73
On the 30*30cm	Ground plane(center edge)	58.31	70.49	60.87
On the 30*30cm	Ground plane(off center edge)	62.11	73.46	61.90
Average Gain (dBi)				
In free space		-4.78	-5.18	-5.28
On the 10*10cm	Ground plane(center edge)	-1.98	-1.46	-1.75
On the 10*10cm	Ground plane(off center edge)	-2.53	-1.65	-2.10
On the 20*20cm	Ground plane(center)	-1.92	-1.46	-1.94
On the 20*20cm	Ground plane(off center edge)	-2.04	-0.90	-1.57
On the 30*30cm	Ground plane(center edge)	-2.34	-1.52	-2.16
On the 30*30cm	Ground plane(off center edge)	-2.07	-1.34	-2.08
Peak Gain (dBi)				
In free space		0.89	0.40	0.12
On the 10*10cm	Ground plane(center edge)	2.02	2.45	2.37
On the 10*10cm	Ground plane(off center edge)	3.46	4.09	3.47
On the 20*20cm	Ground plane(center edge)	4.26	4.54	3.69
On the 20*20cm	Ground plane(off center edge)	4.02	5.40	4.65
On the 30*30cm	Ground plane(center edge)	3.64	4.85	4.06
On the 30*30cm	Ground plane(off center edge)	3.79	4.23	3.15
Radiation	Omnidirectional			
Polarization	Linear			
Impedance	50Ω			
Max Input Power	10W			
MECHANICAL				
Antenna Dimension	19.8*14.3*16.4mm			
Casing	ABS			
Connector	RP-SMA(M)			
Weight	6g			
Ingress Protection Rating	IP67 (Housing only)			

ENVIRONMENTAL	
Operation Temperature	-40°C ~ + 85°C
Storage Temperature	-40°C ~ + 85°C
Humidity	Non-condensing 65°C 95% RH

3. Antenna Characteristics

3.1 Testing Setup

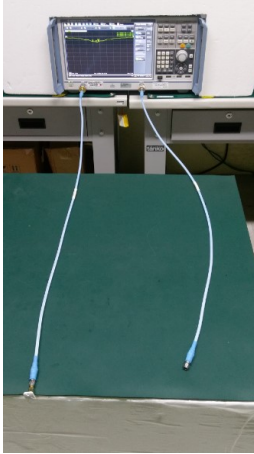

a) In free space

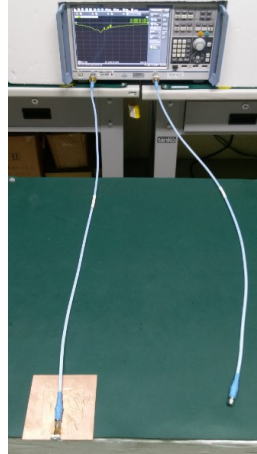

b) With 10*10cm
ground plane center
edge

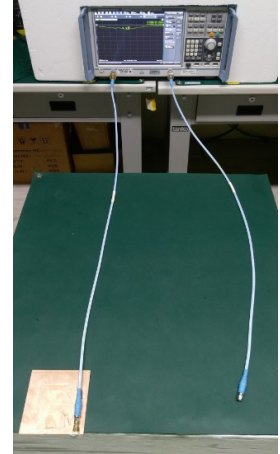

c) With 10*10cm
ground plane off center
edge

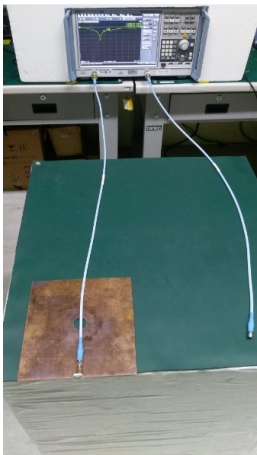

d) With 20*20cm
ground plane center
edge

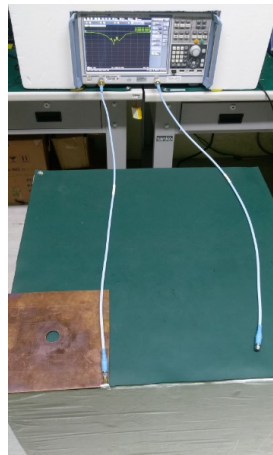

e) With 20*20cm
ground plane off
center edge

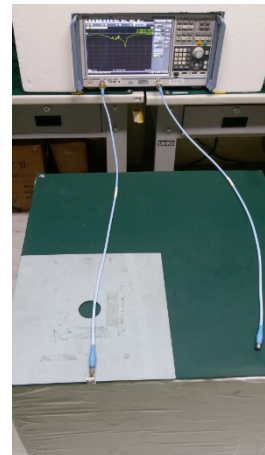

f) With 30*30cm
ground plane center
edge

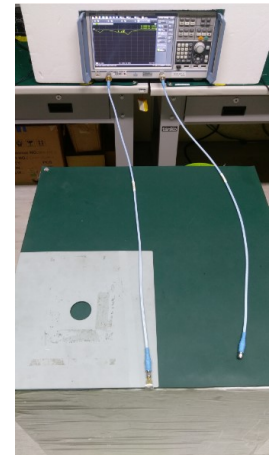

g) With 30*30cm
ground plane off center
edge

Figure.1 Antenna Measurement Setup

3.2 Return Loss (In free space)

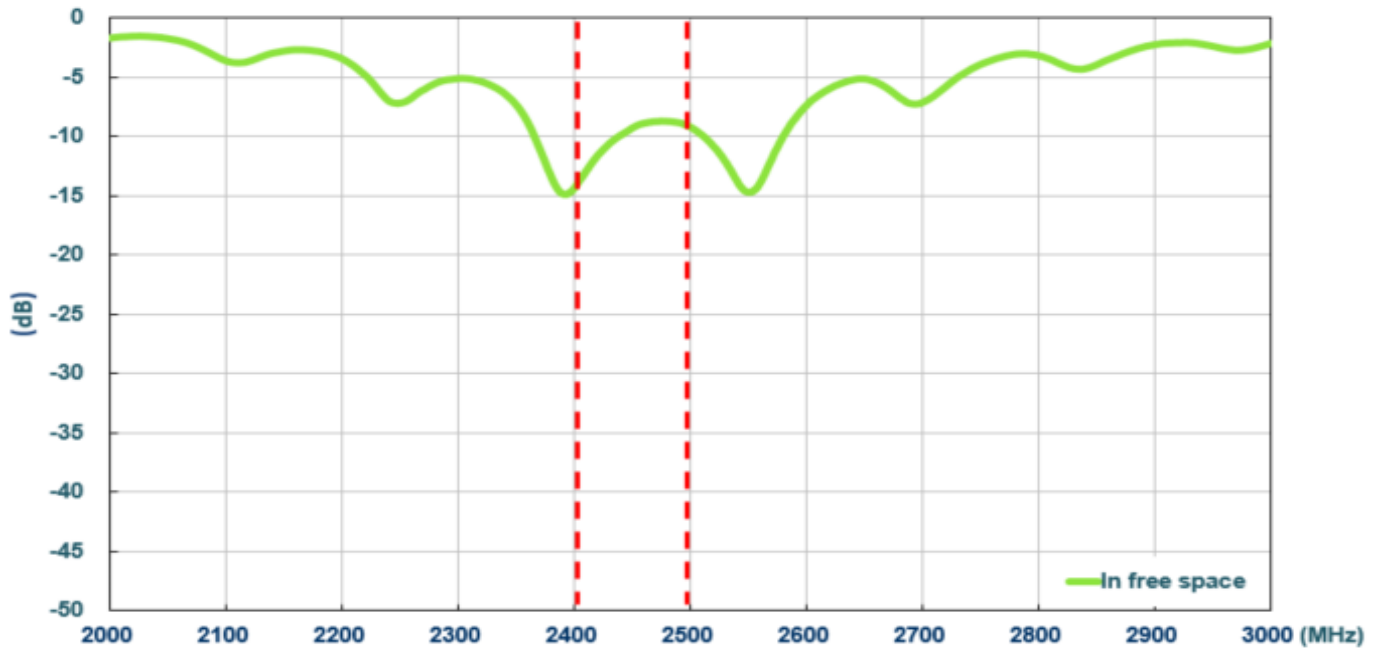

Figure 2. Return loss of WCM.01 antenna

3.3 Return Loss(On ground plane center edge)

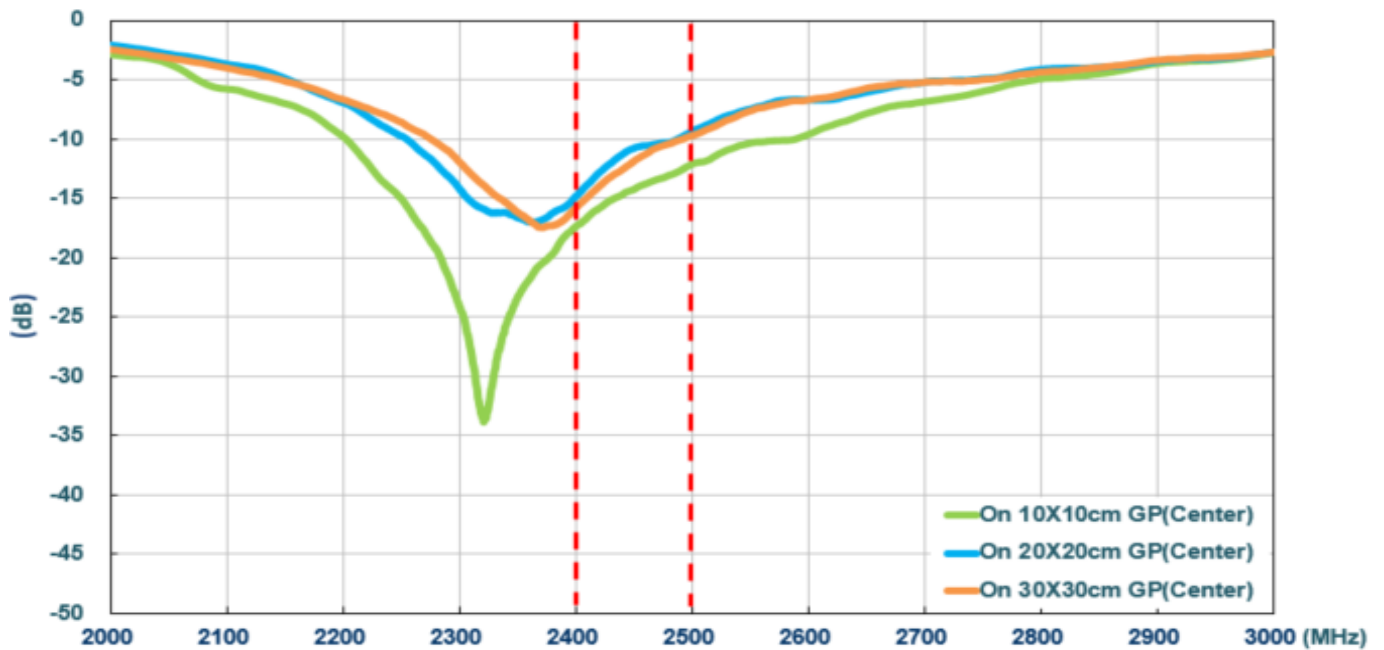

Figure 3. Return loss of WCM.01 antenna with different ground plane size

3.4 Return Loss (On ground plane off center edge)

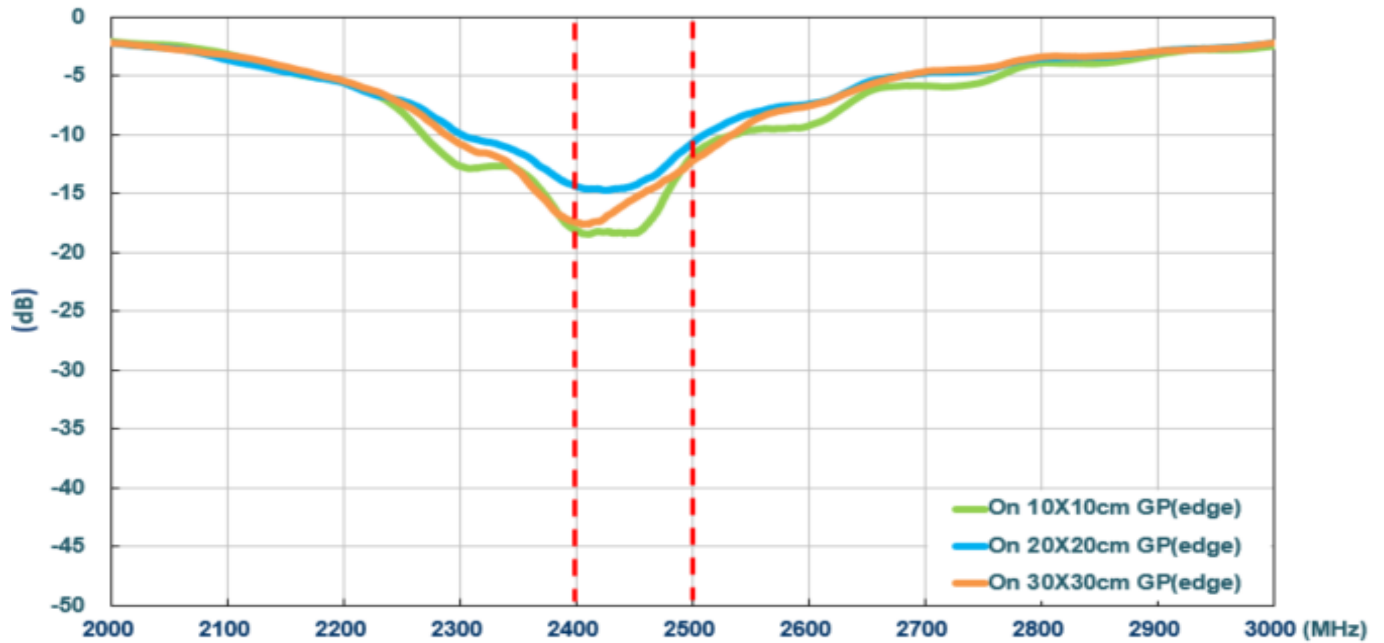

Figure 4. Return loss of WCM.01 antenna with different ground plane size

3.5 Efficiency (In free space)

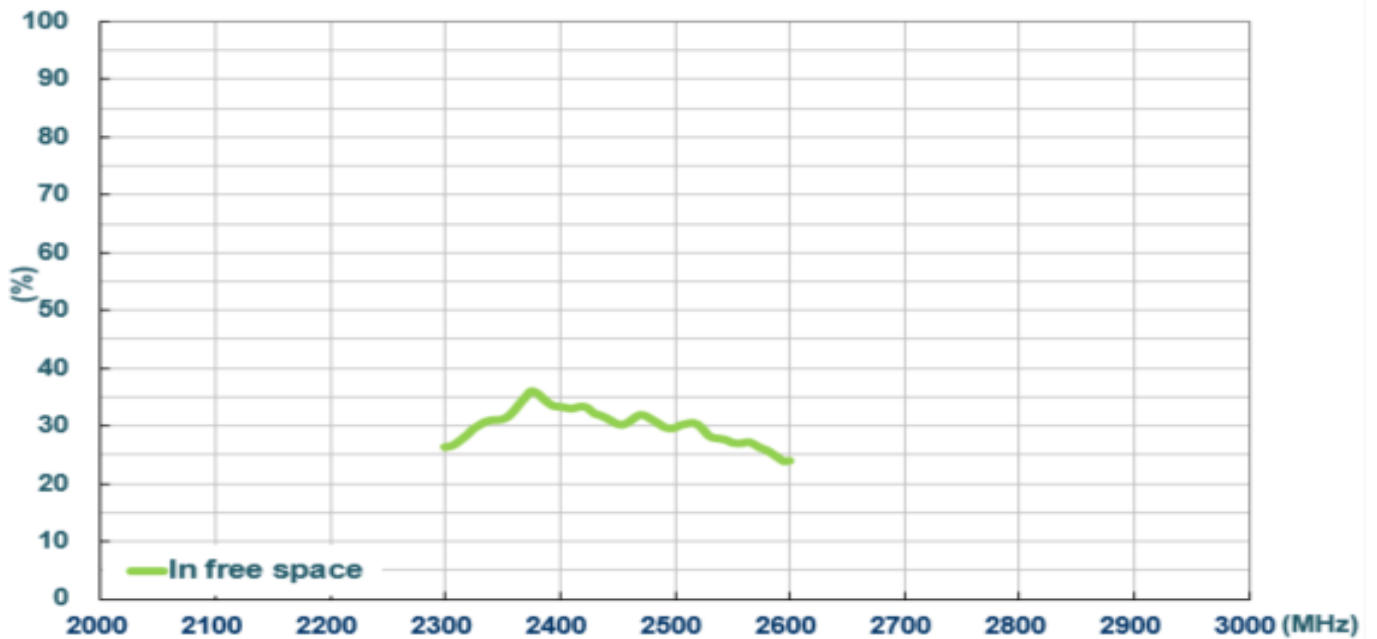

Figure 5. Efficiency of WCM.01 antenna

3.6 Efficiency (On ground plane center edge)

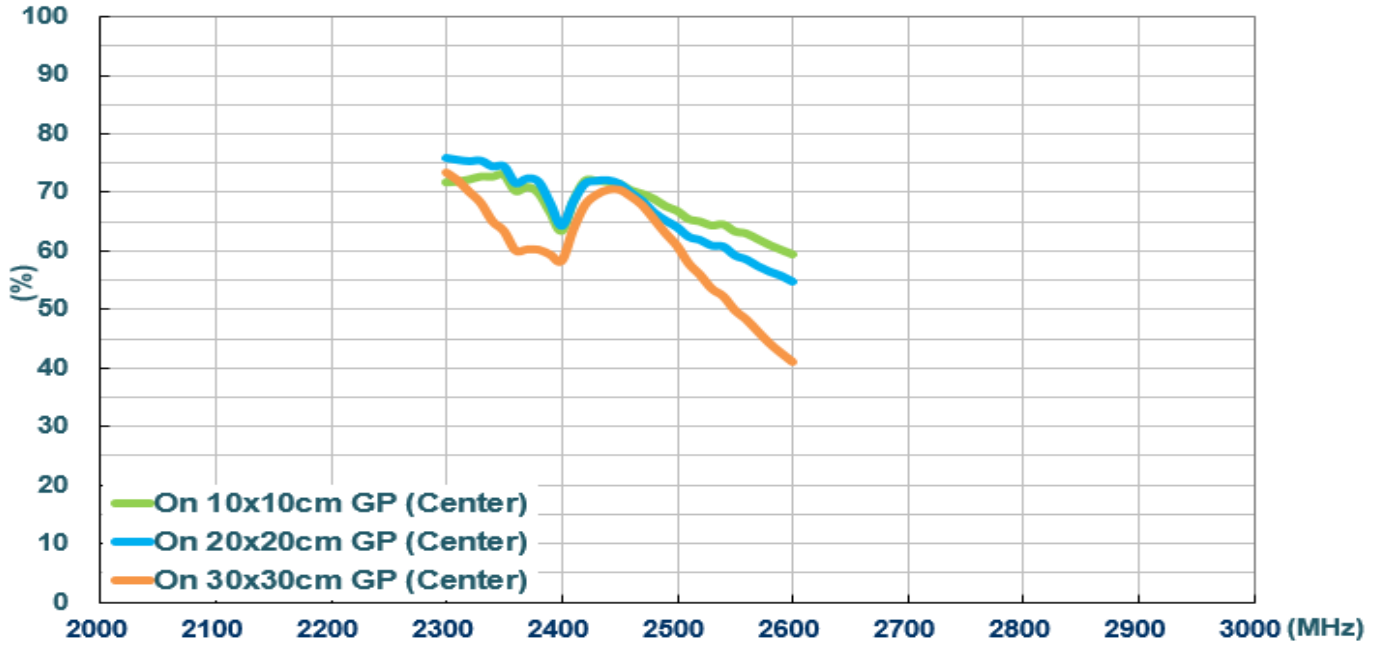

Figure 6. Return loss of WCM.01 antenna with different ground plane size

3.7 Efficiency (On ground plane off center edge)

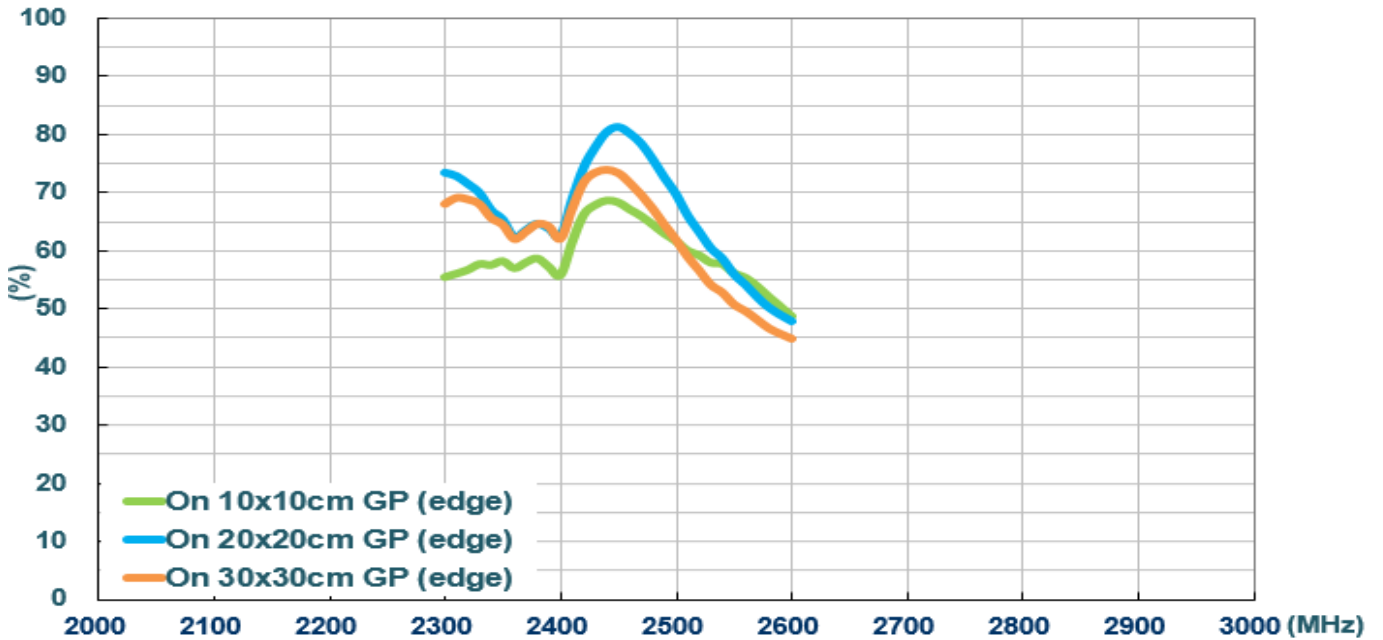

Figure 7. Return loss of WCM.01 antenna with different ground plane size

3.8 Peak Gain (In free space)

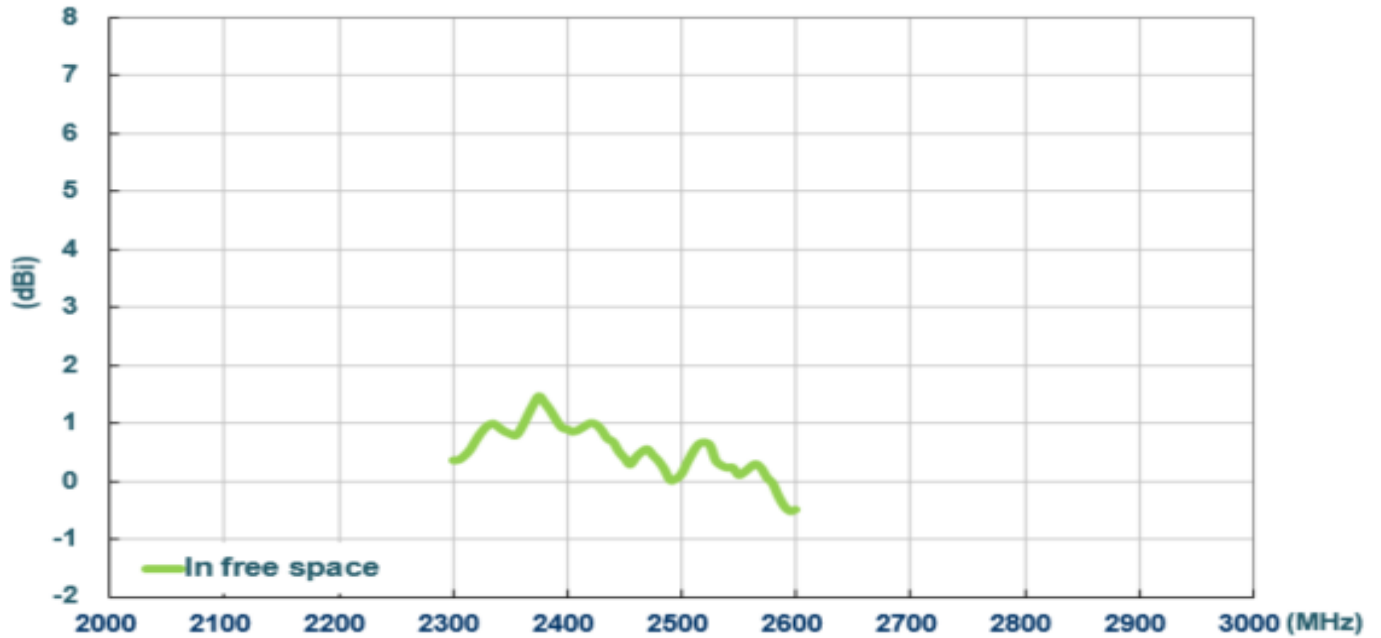

Figure 8. Peak gain of WCM.01 antenna with different ground plane size

3.9 Peak Gain (On ground plane center edge)

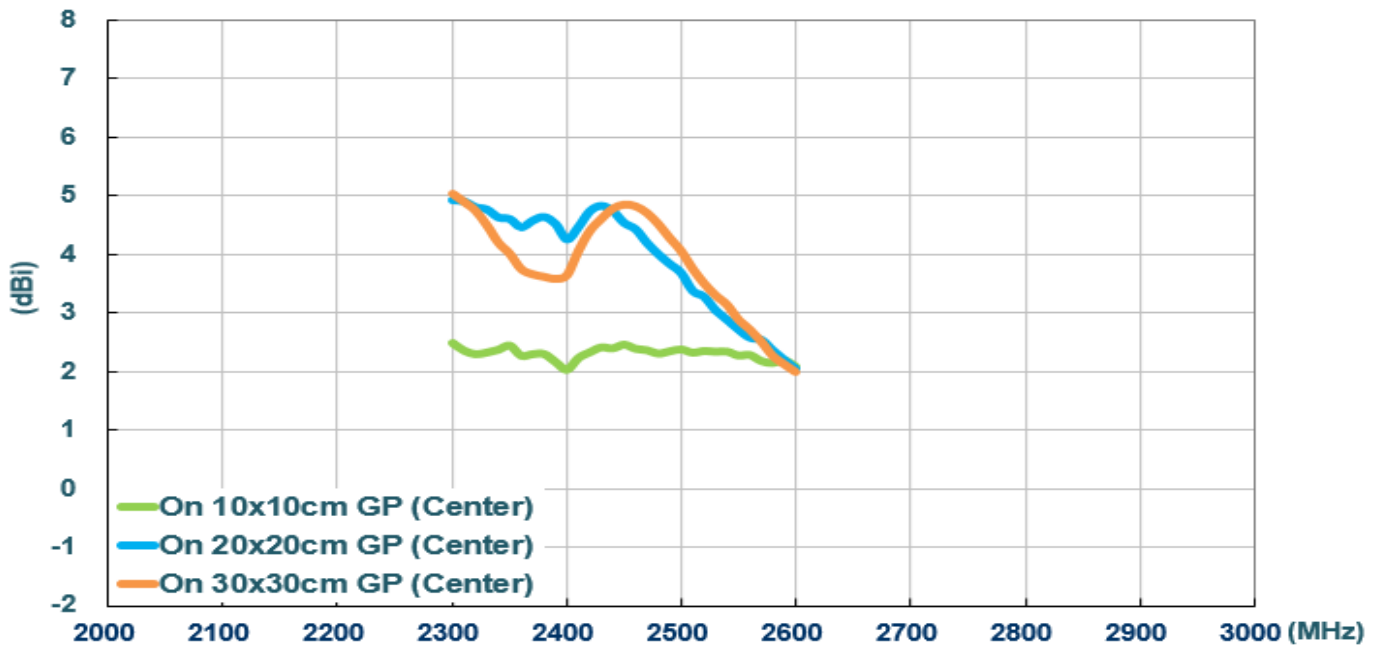

Figure 9. Peak gain of WCM.01 antenna with different ground plane size

3.10 Peak Gain (On ground plane off center edge)

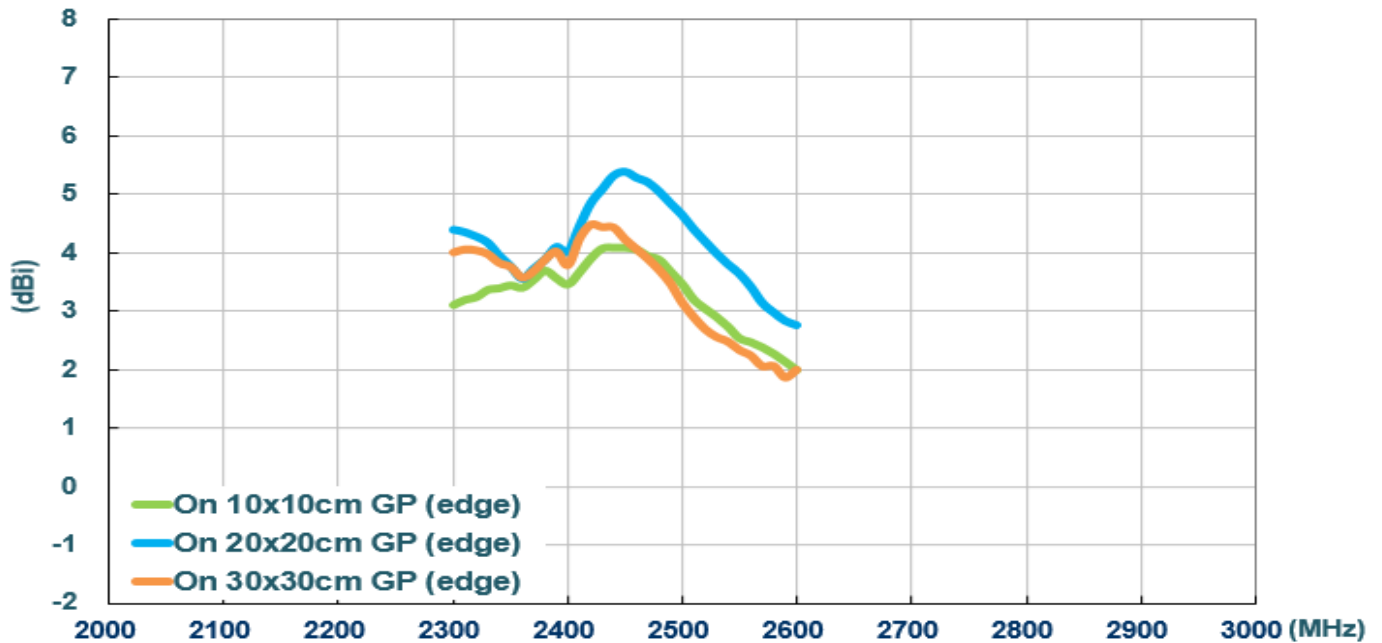

Figure 10. Peak gain of WCM.01 antenna with different ground plane size

3.11 Average Gain (In free space)

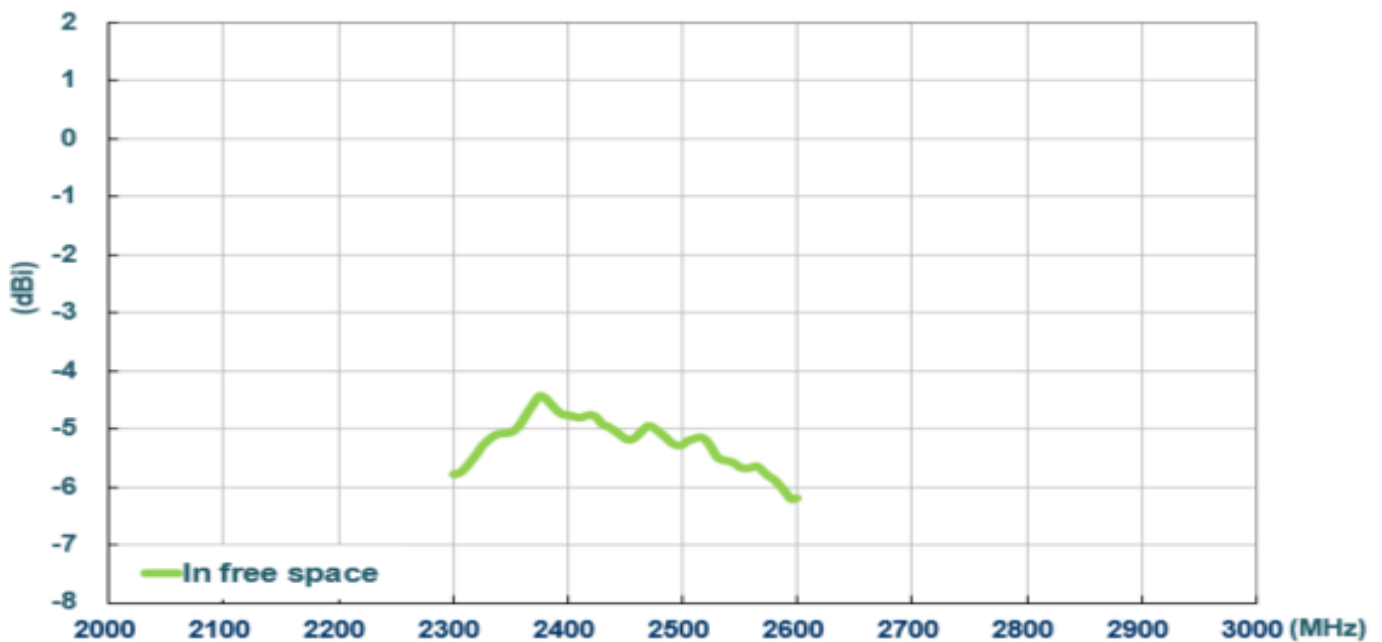

Figure 11. Average gain of WCM.01

3.12 Average Gain (On ground plane center edge)

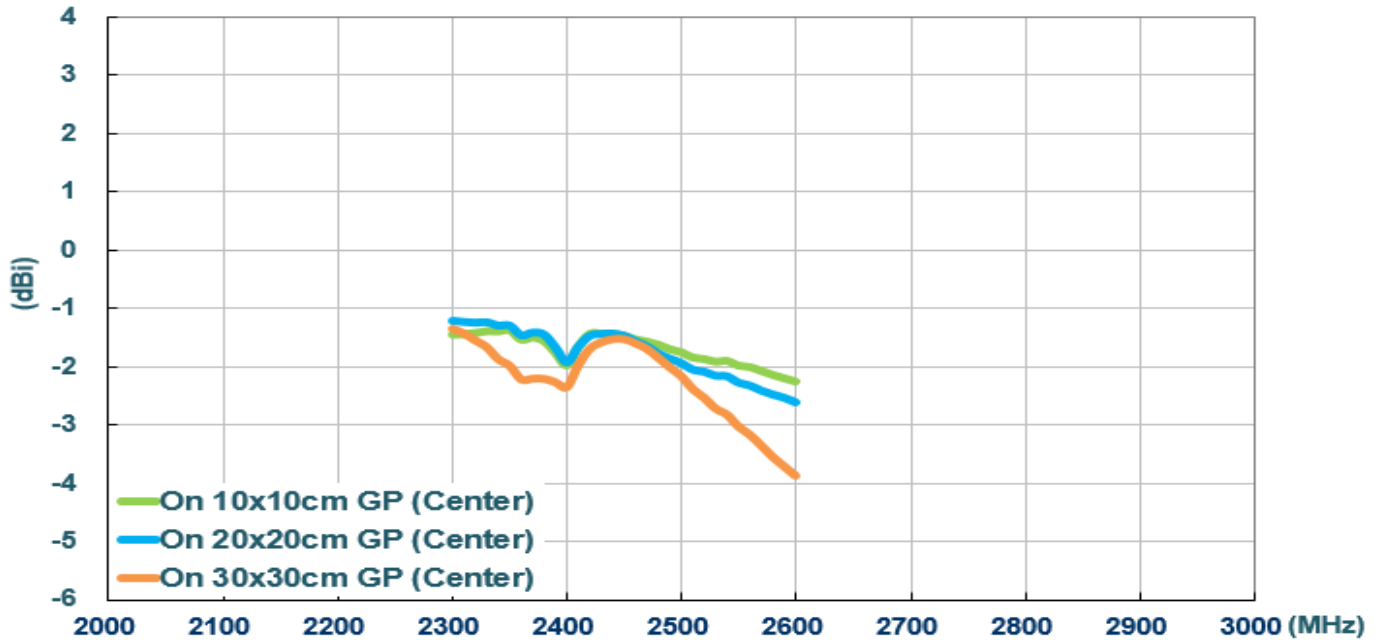

Figure 12. Average gain of WCM.01 antenna with different ground plane size

3.13 Average Gain (On ground plane off center edge)

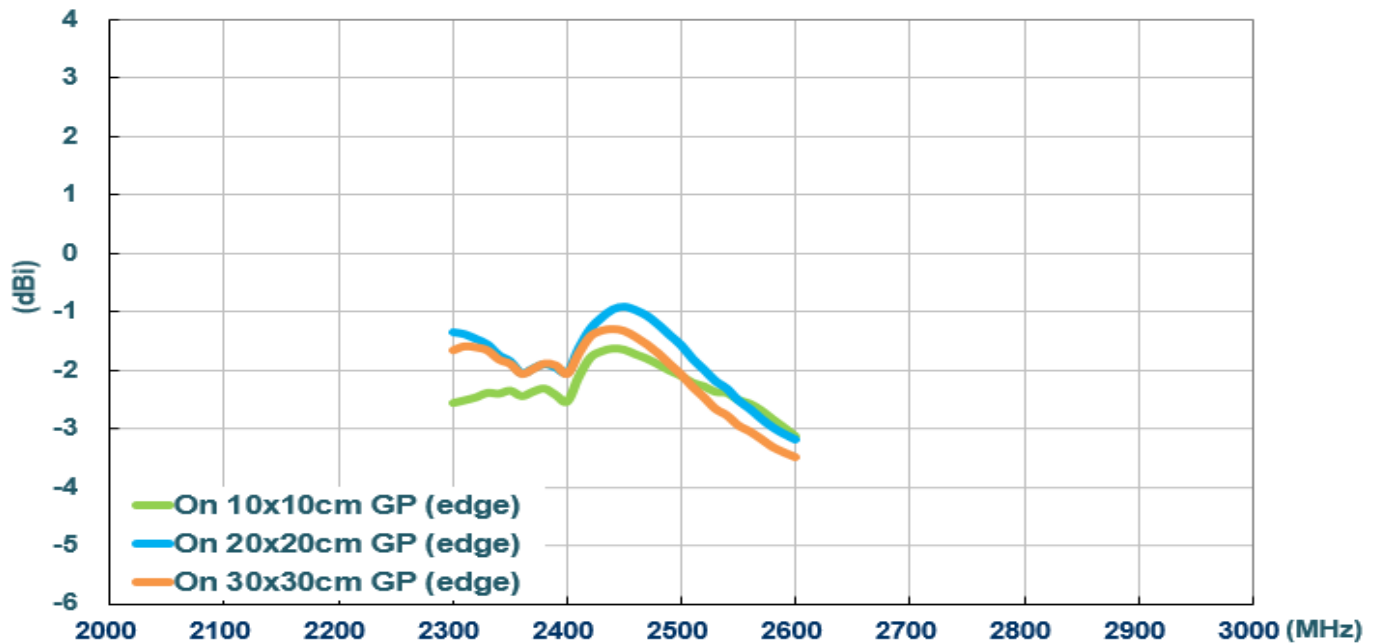

Figure 13. Average gain of WCM.01 antenna with different ground plane size

4. Antenna Radiation Patterns

The antenna radiation patterns were measured in a CTIA certified ETS Anechoic Chamber. The measurement setup is shown below.



In Free Space

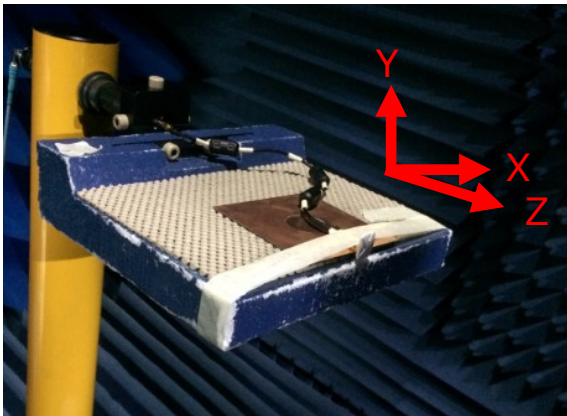

On 10*10cm ground plane (Center Edge)

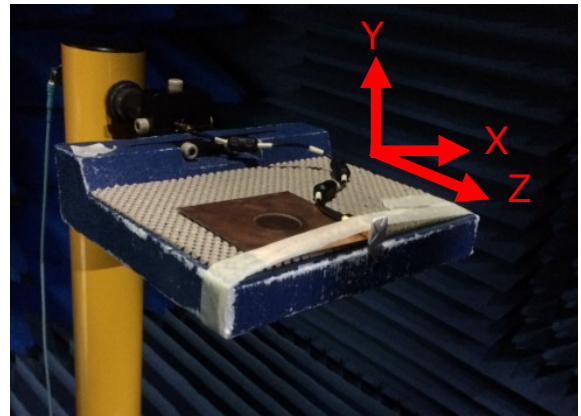

On 10*10cm ground plane (Off Center Edge)

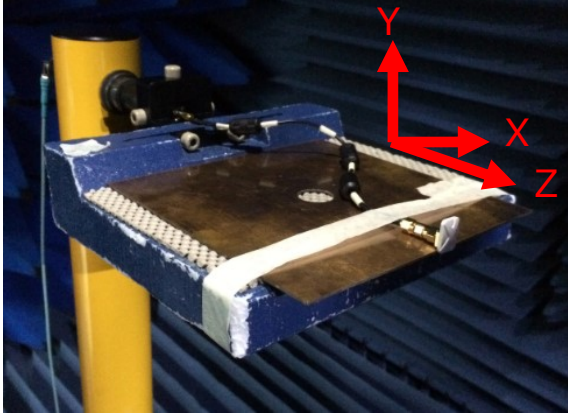

On 20*20cm ground plane (Center Edge)

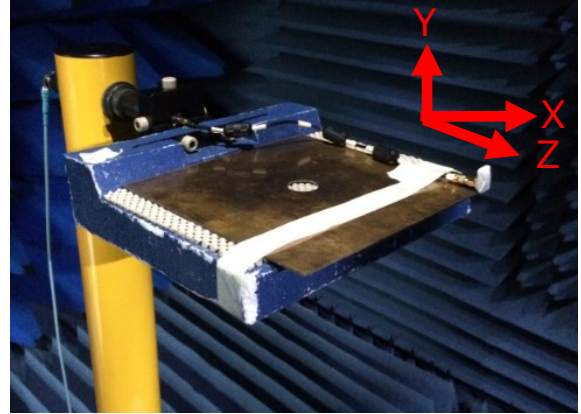

On 20*20cm ground plane (Off Center Edge)

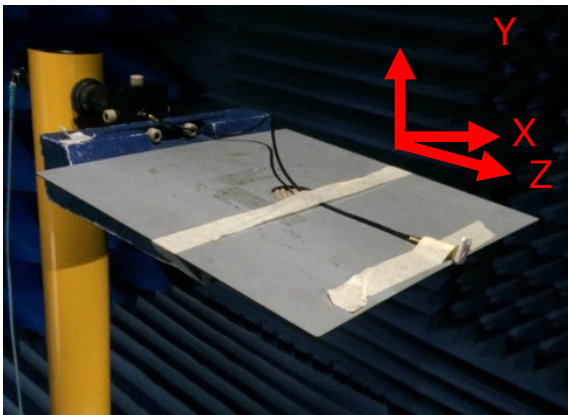

On 30*30cm ground plane (Center Edge)

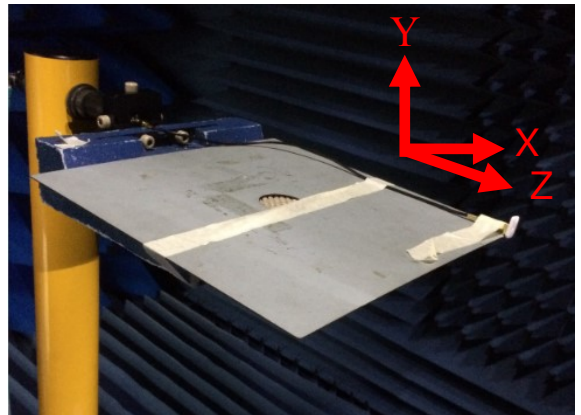

On 30*30cm ground plane (Off Center Edge)

Figure.14. Testing Setup in ETS Anechoic Chamber

4.1 2D Radiation Pattern (In free space)

XY Plane

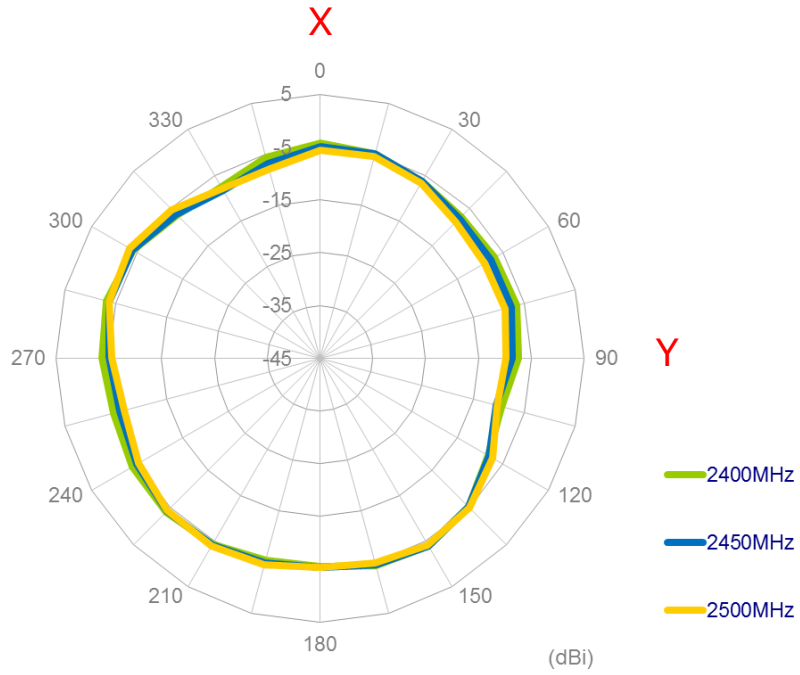

XZ Plane

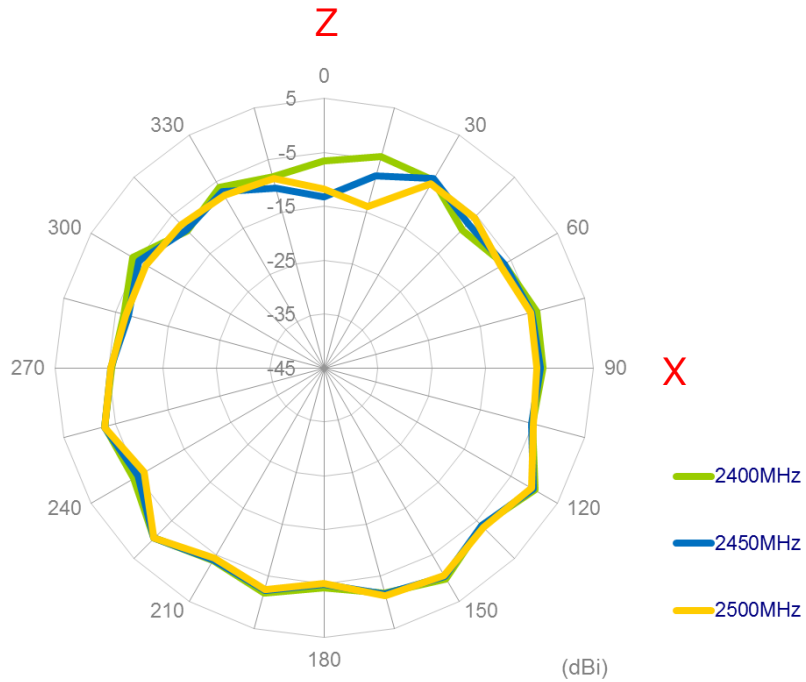

YZ Plane

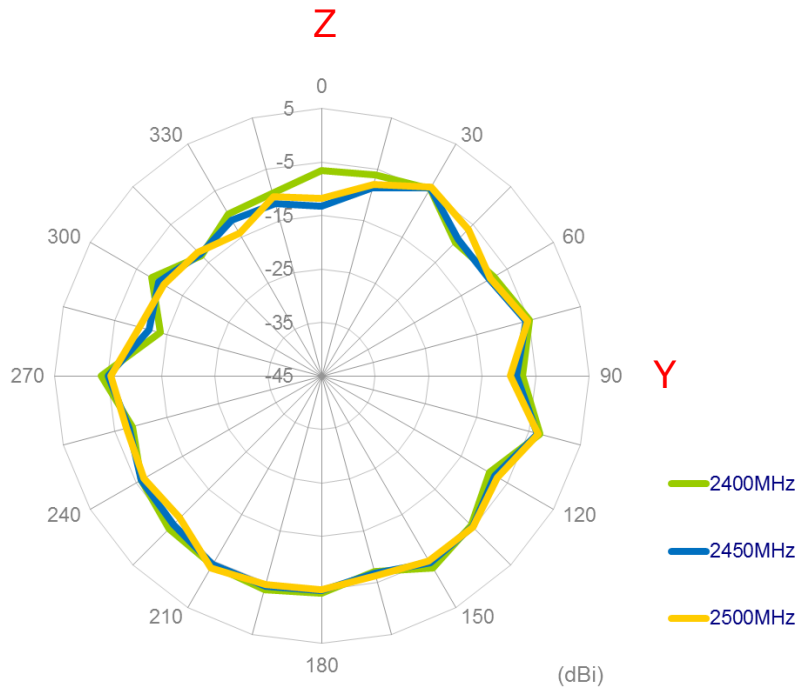

4.2 3D Radiation Pattern (In free space)

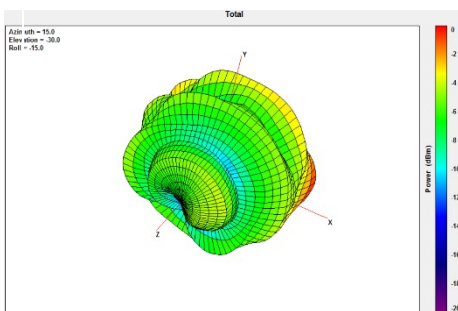

2400MHz

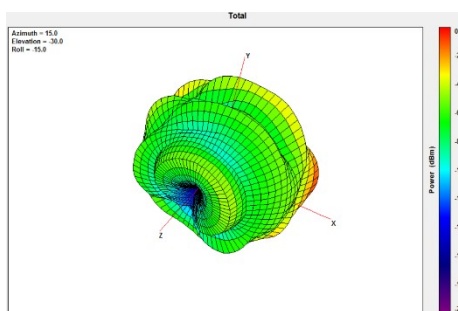

2450MHz

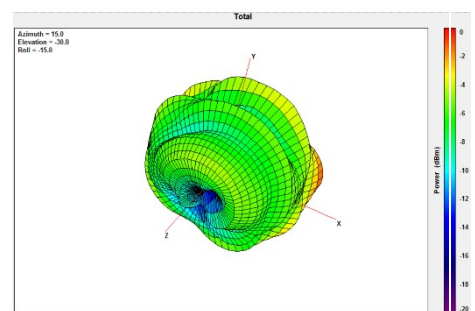

2500MHz

4.3 2D Radiation Pattern (On 10*10cm ground plane center edge)

XY Plane

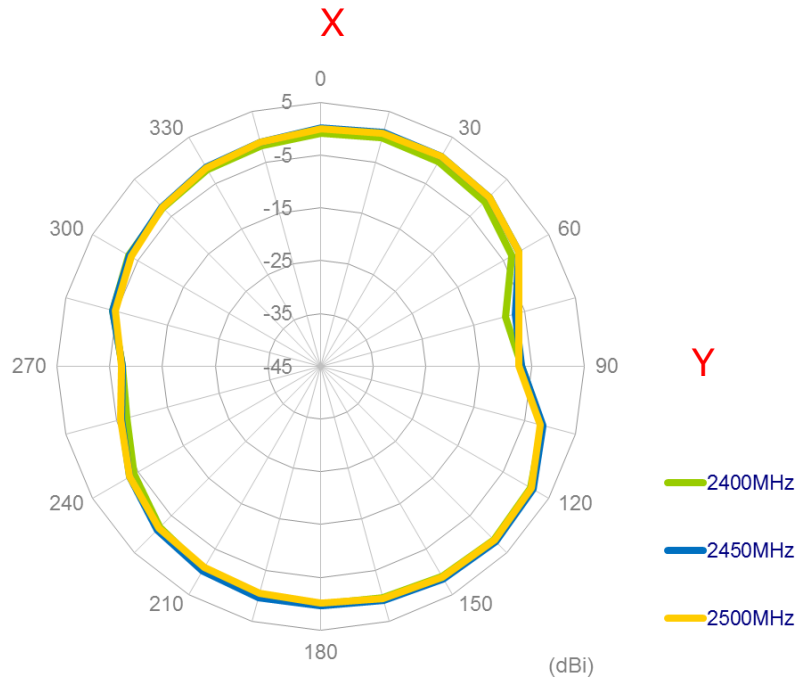

XZ Plane

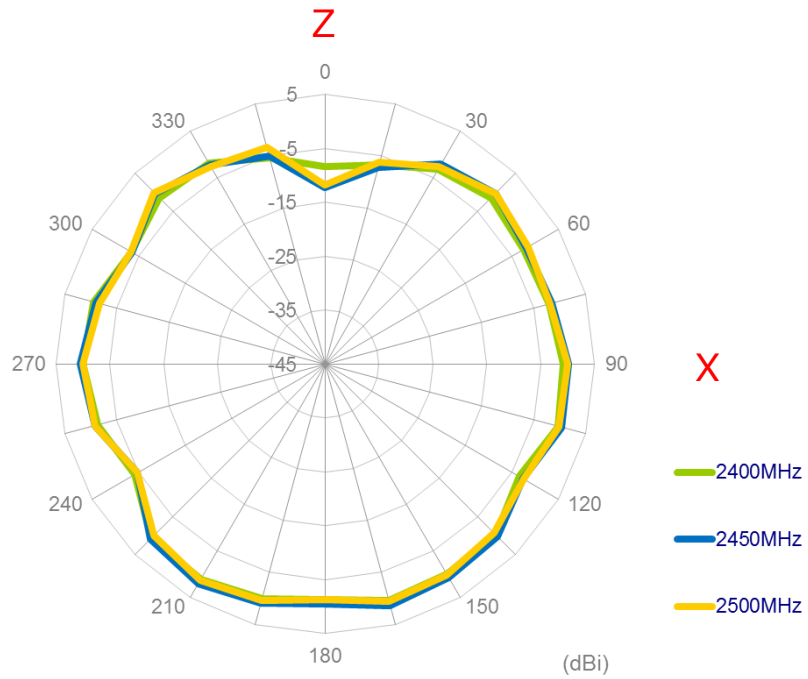

YZ Plane

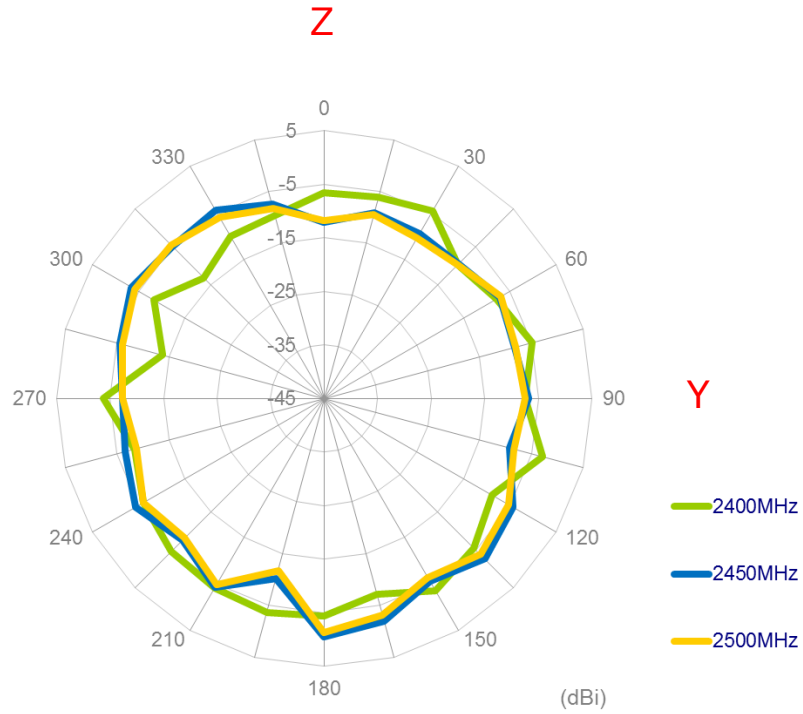

4.4 3D Radiation Pattern (On 10*10cm ground plane center edge)

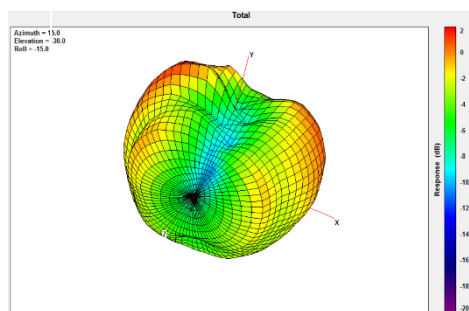

2400MHz

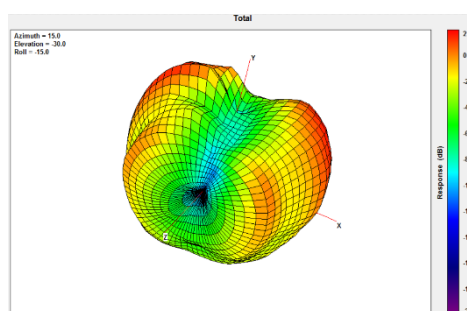

2450MHz

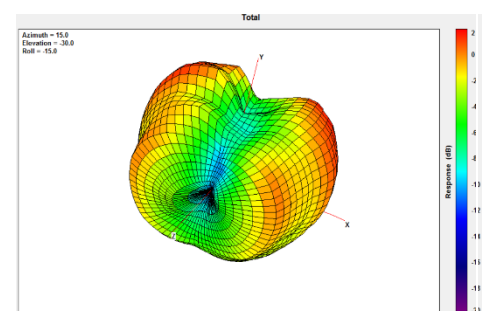

2500MHz

4.5 2D Radiation Pattern (On 10*10cm ground plane off center edge)

XY Plane

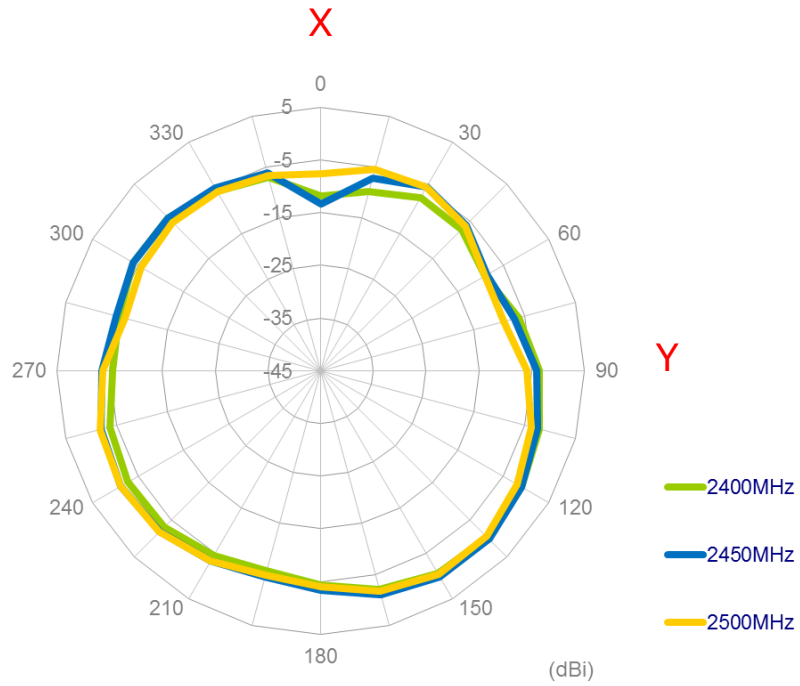

XZ Plane

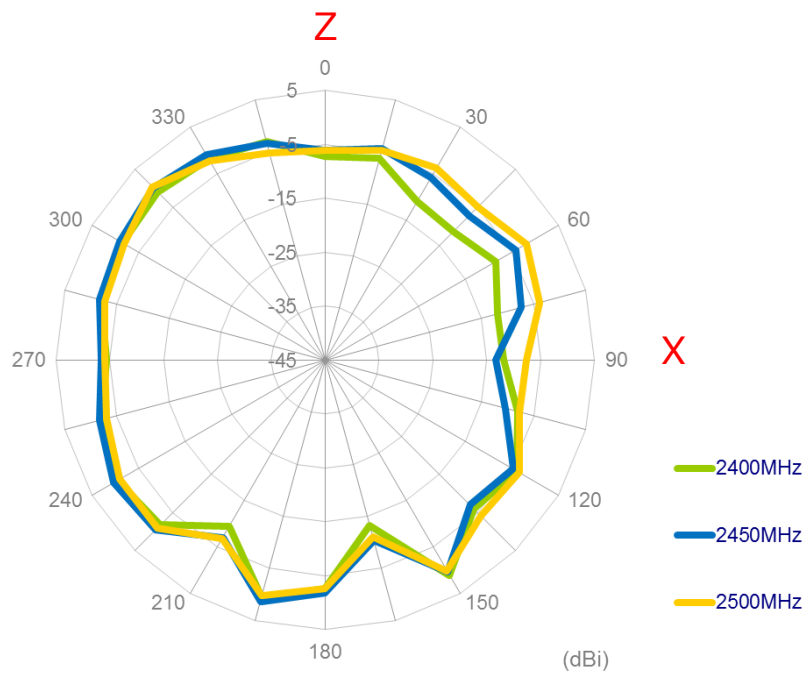

YZ Plane

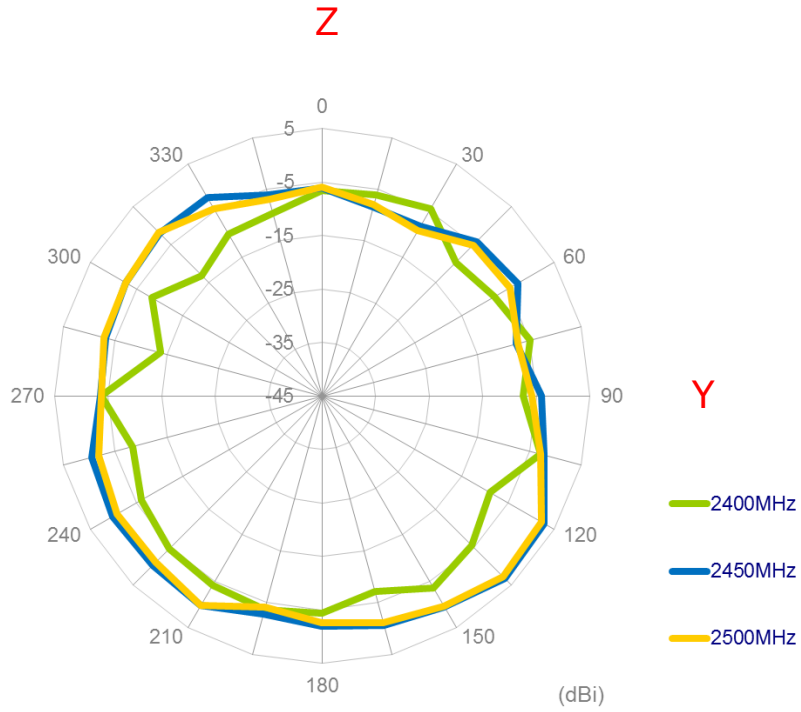

4.6 3D Radiation Pattern (On 10*10cm ground plane off center edge)

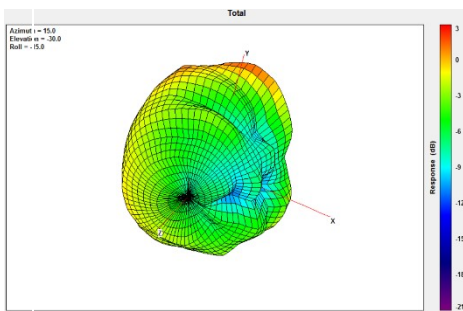

2400MHz

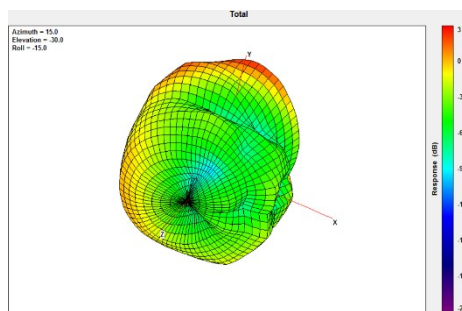

2450MHz

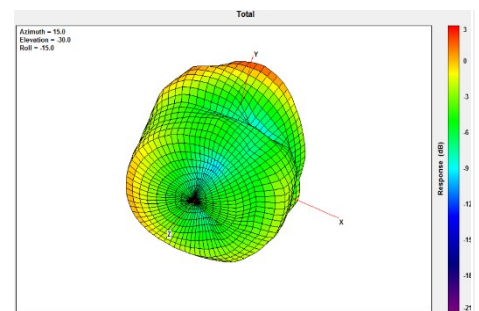

2500MHz

4.7 2D Radiation Pattern (On the 20*20cm ground plane center edge)

XY Plane

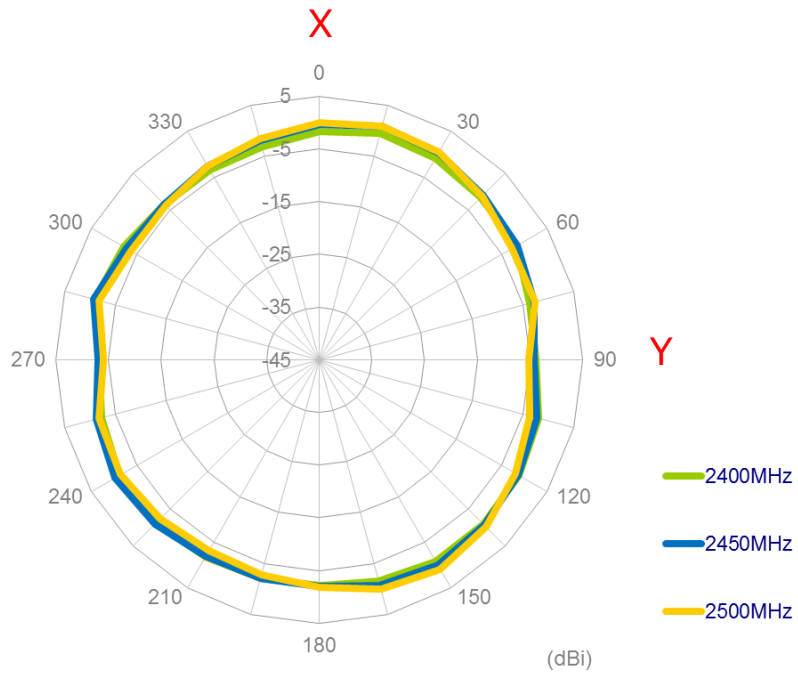

XZ Plane

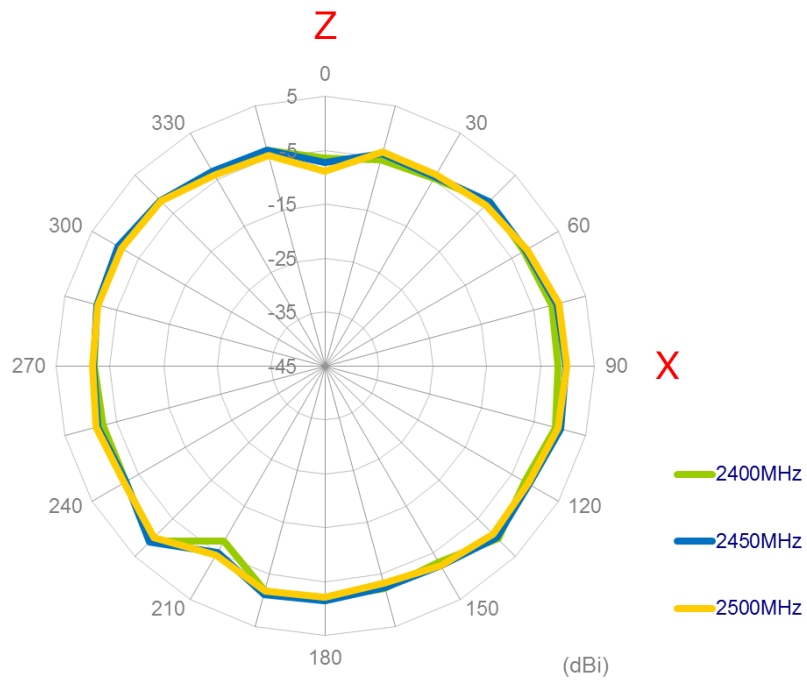

YZ Plane

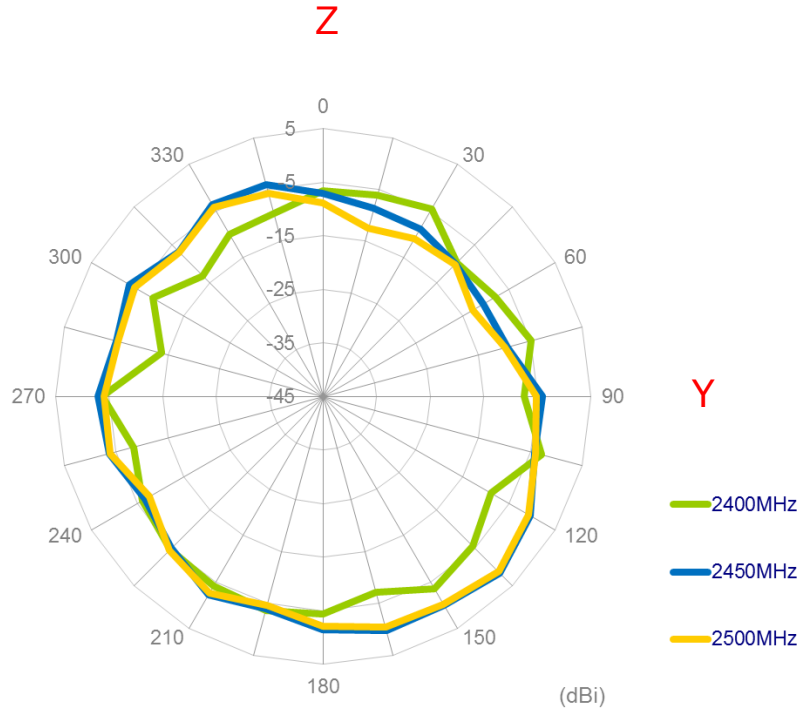

4.8 3D Radiation Pattern (On 20*20cm ground plane center edge)

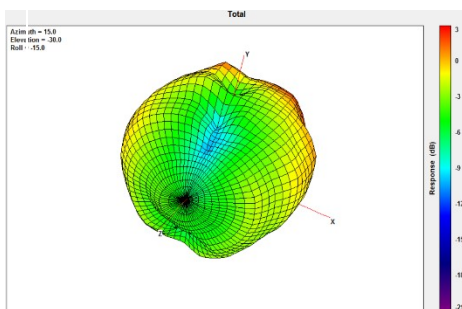

2400MHz

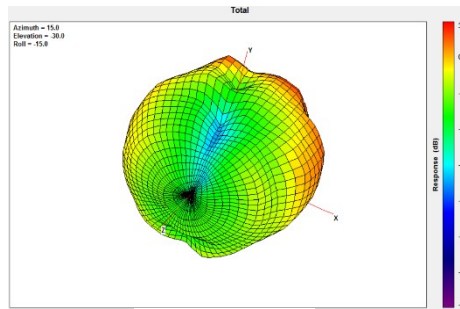

2450MHz

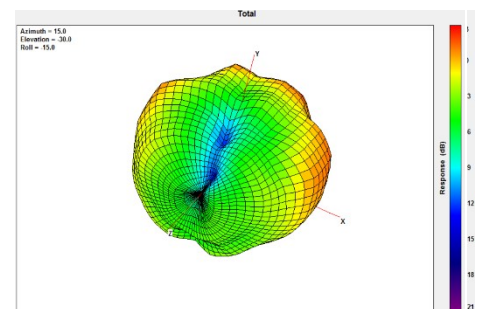

2500MHz

4.9 2D Radiation Pattern (On 20*20cm ground plane off center edge)

XY Plane

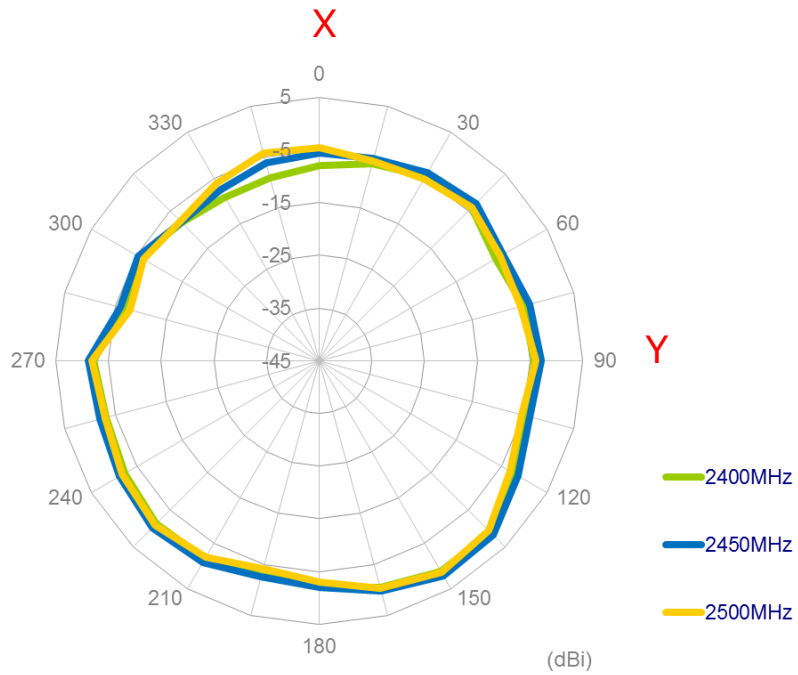

XZ Plane

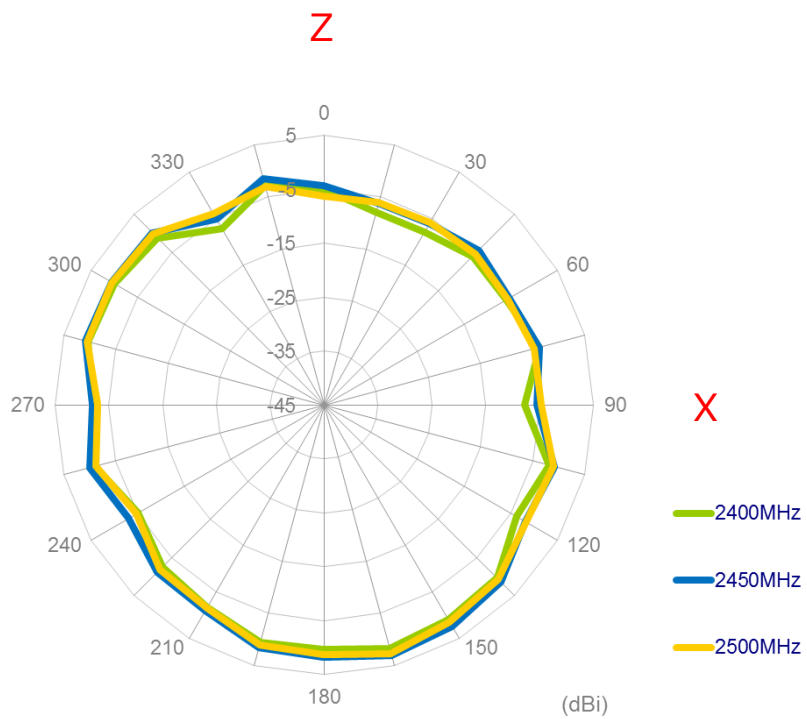

YZ Plane

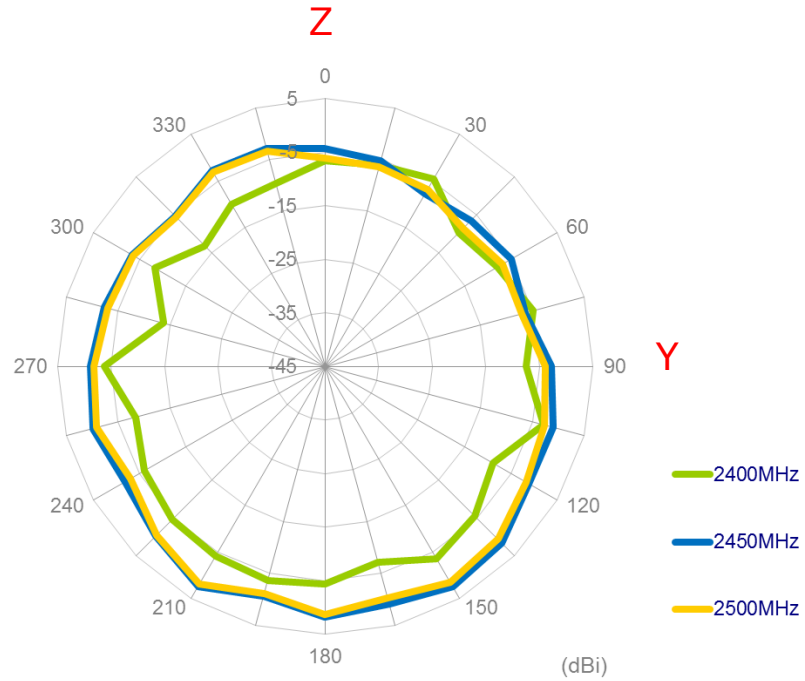

4.10 3D Radiation Pattern (On 20*20cm ground plane off center edge)

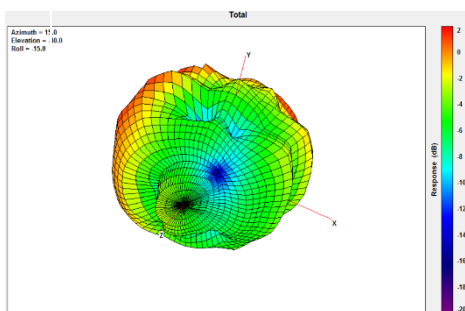

2400MHz

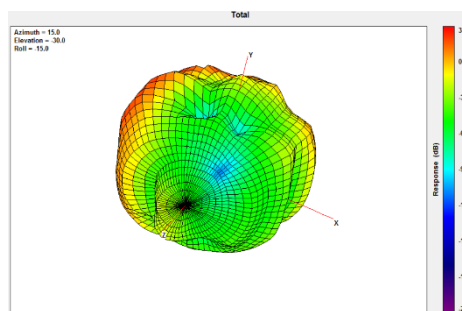

2450MHz

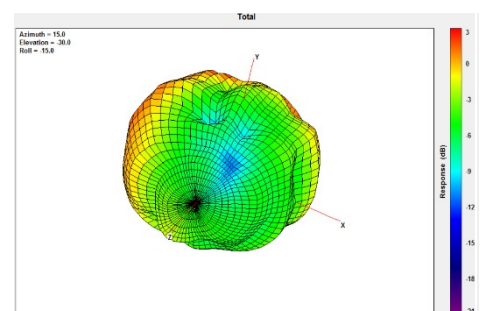

2500MHz

4.11 2D Radiation Pattern (On 30*30cm ground plane off center edge)

XY Plane

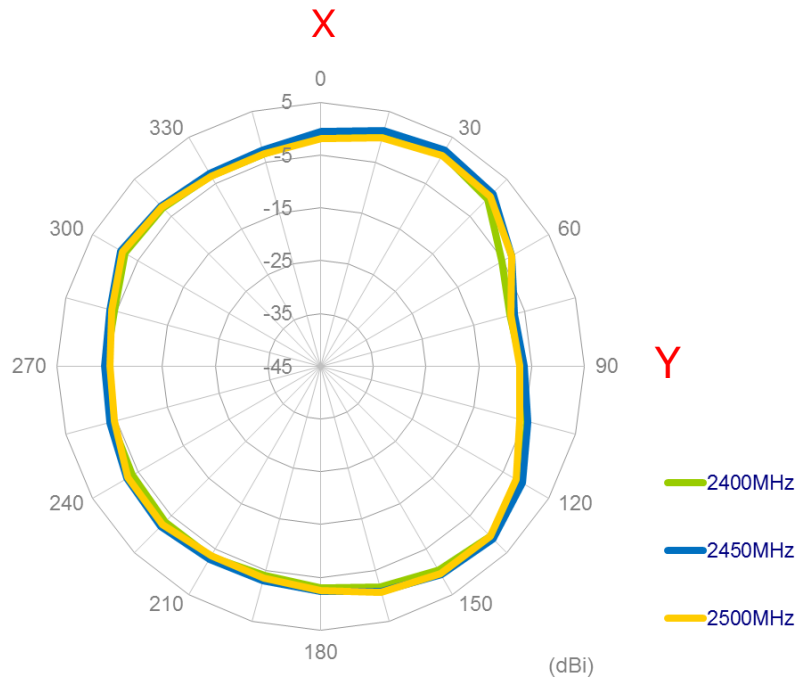

XZ Plane

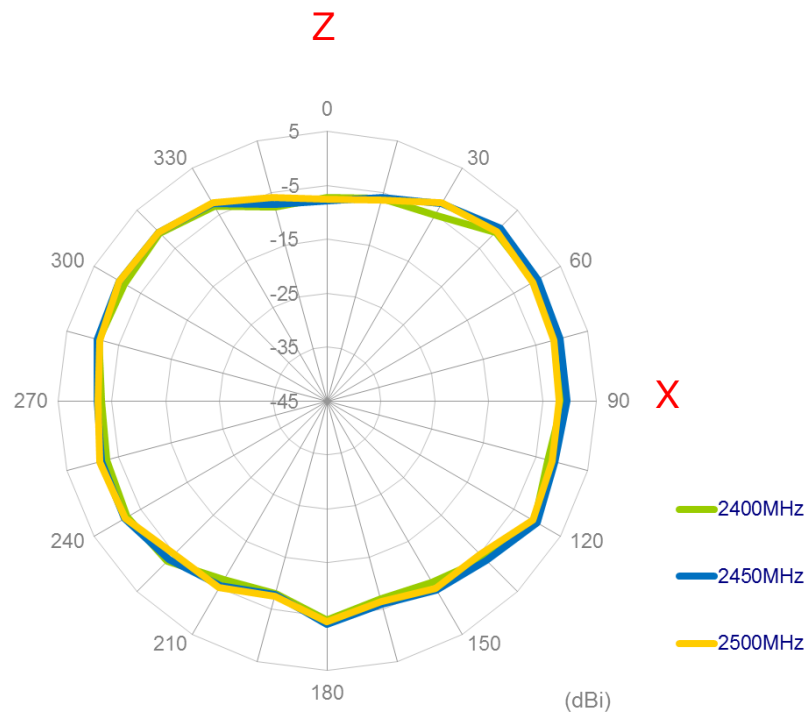

YZ Plane

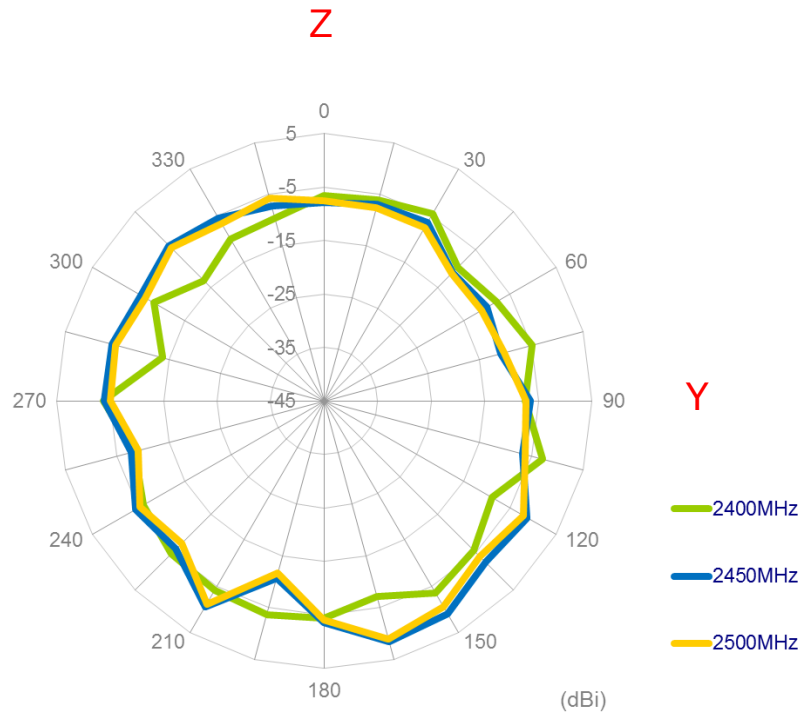

4.12 3D Radiation Pattern (On 30*30cm ground plane center edge)

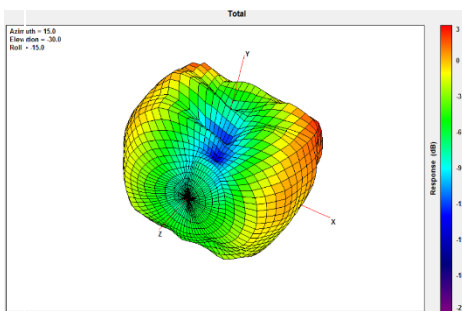

2400MHz

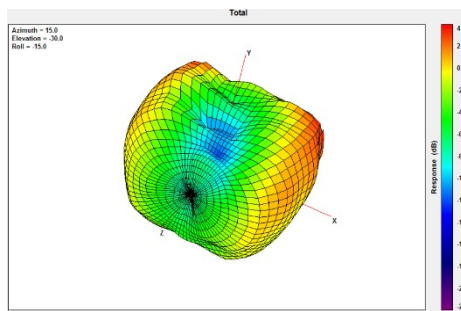

2450MHz

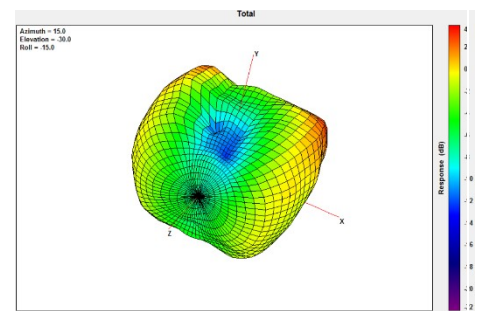

2500MHz

4.13 2D Radiation Pattern (On 30*30cm ground plane off center edge)

XY Plane

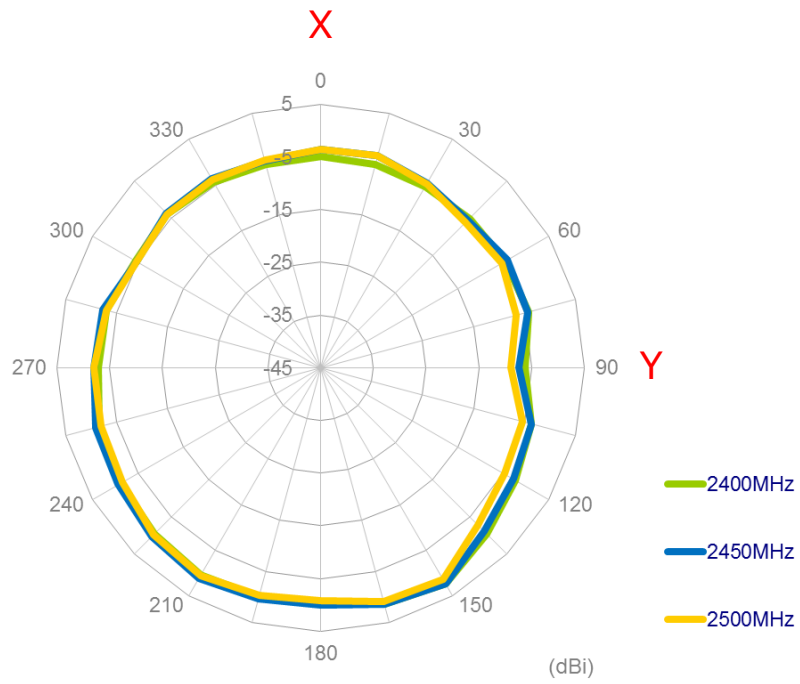

XZ Plane

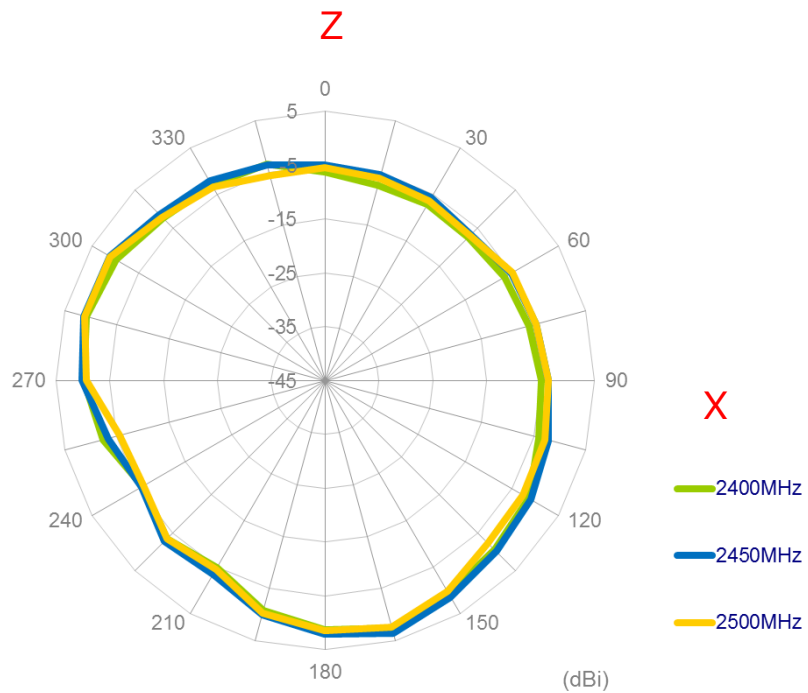

YZ Plane

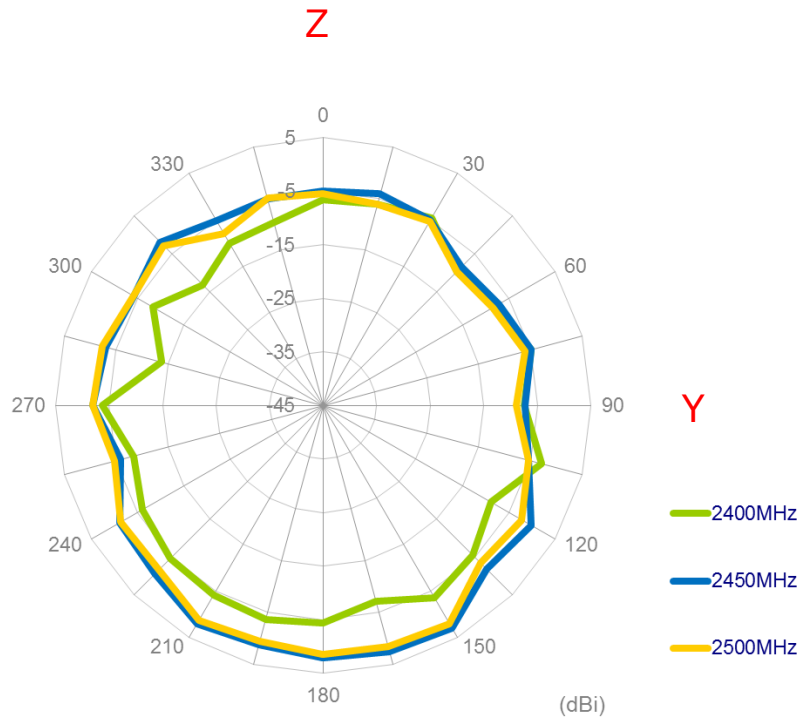

4.14 3D Radiation Pattern (On 30*30cm ground plane off center edge)

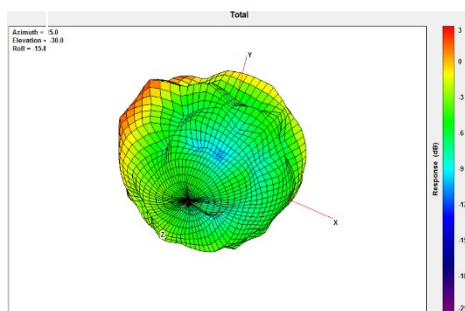

2400MHz

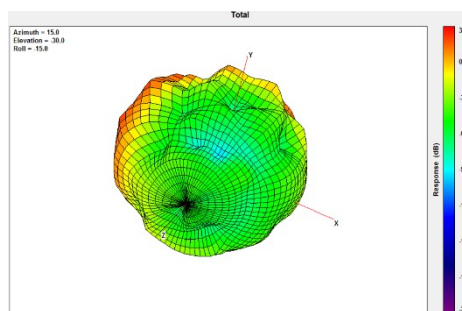

2450MHz

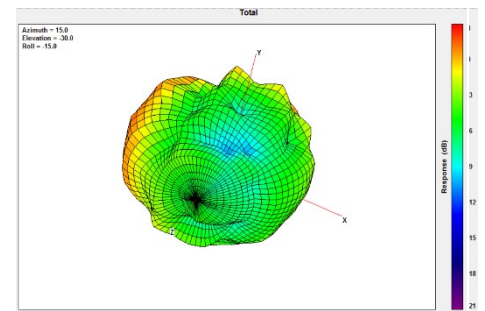

2500MHz

5. DRAWING (Unit: mm)



3D View

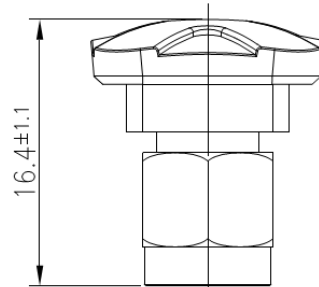

Top View

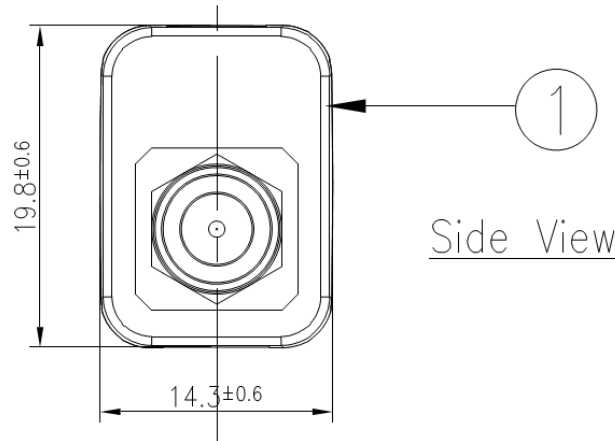

Side View

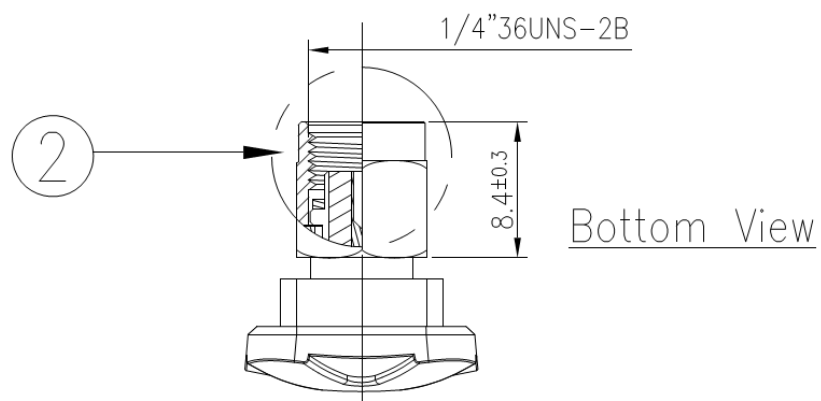

Bottom View

	Name	Material	Finish	QTY
1	External housing	ABS	White	1
2	RP-SMA(M)	Brass	Au Plated	1

6. Packaging

1 pcs WCM.01.0151W per PE Bag
 PE Bag Dimensions - 80*40mm
 Weight - .007g

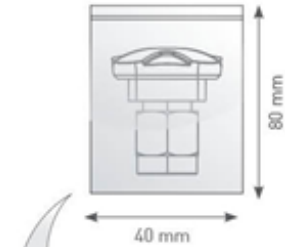

100 PE Bags per Large PE Bag
 100 pcs WCM.01.0151W per Large PE Bag
 Large Polybag Dimensions - 240*170mm
 Weight - 0.7kg

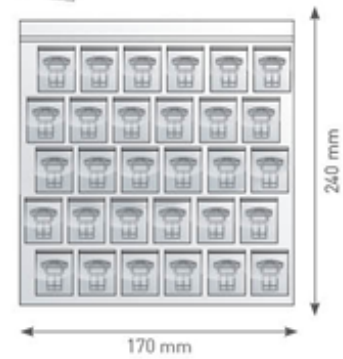

15 Large PE bags per carton
 1500 pcs WCM.01.0151W per carton
 Carton Dimensions - 360*310*160mm
 Weight - 11kg

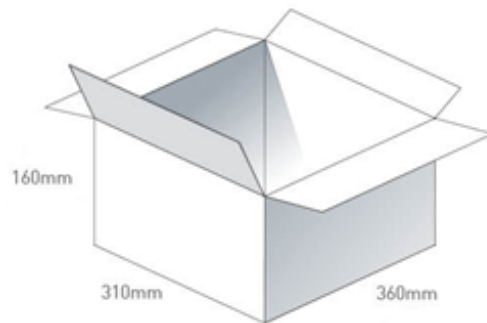

Pallet Dimensions 1080mm*930m*1430mm
 72 Cartons per Pallet
 12 Cartons per layer
 6 Layers

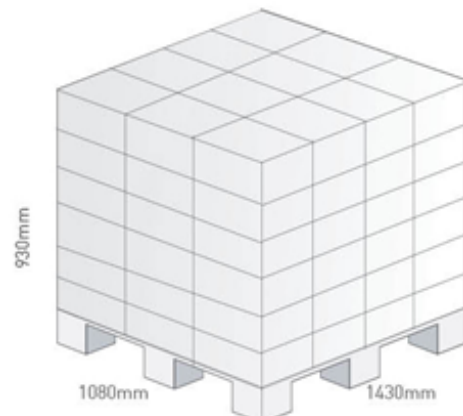

Taoglas makes no warranties based on the accuracy or completeness of the contents of this document and reserves the right to make changes to specifications and product descriptions at any time. Taoglas reserves all rights to this document and the information contained herein.

Reproduction, use or disclosure to third parties without express permission is strictly prohibited.

Copyright © Taoglas



Компания «ЭлектроПласт» предлагает заключение долгосрочных отношений при поставках импортных электронных компонентов на взаимовыгодных условиях!

Наши преимущества:

- Оперативные поставки широкого спектра электронных компонентов отечественного и импортного производства напрямую от производителей и с крупнейших мировых складов;
- Поставка более 17-ти миллионов наименований электронных компонентов;
- Поставка сложных, дефицитных, либо снятых с производства позиций;
- Оперативные сроки поставки под заказ (от 5 рабочих дней);
- Экспресс доставка в любую точку России;
- Техническая поддержка проекта, помощь в подборе аналогов, поставка прототипов;
- Система менеджмента качества сертифицирована по Международному стандарту ISO 9001;
- Лицензия ФСБ на осуществление работ с использованием сведений, составляющих государственную тайну;
- Поставка специализированных компонентов (Xilinx, Altera, Analog Devices, Intersil, Interpoint, Microsemi, Aeroflex, Peregrine, Syfer, Eurofarad, Texas Instrument, Miteq, Cobham, E2V, MA-COM, Hittite, Mini-Circuits, General Dynamics и др.);

Помимо этого, одним из направлений компании «ЭлектроПласт» является направление «Источники питания». Мы предлагаем Вам помощь Конструкторского отдела:

- Подбор оптимального решения, техническое обоснование при выборе компонента;
- Подбор аналогов;
- Консультации по применению компонента;
- Поставка образцов и прототипов;
- Техническая поддержка проекта;
- Защита от снятия компонента с производства.



Как с нами связаться

Телефон: 8 (812) 309 58 32 (многоканальный)

Факс: 8 (812) 320-02-42

Электронная почта: org@eplast1.ru

Адрес: 198099, г. Санкт-Петербург, ул. Калинина, дом 2, корпус 4, литера А.