

Description

Tease-free, trip-free, snap action mechanism. Designed for snap-in panel mounting utilising round hole or industry standard fuse-holder cut-out dimensions. Featuring an ergonomically styled two colour actuator with indicator band clearly showing the tripped/OFF position. Approved to CBE standard EN 60934 (IEC 60934): S-type TO CBE

Typical applications

Motors, transformers, solenoids, extra low voltage systems, household and office machines, instrumentation, marine applications, mobile homes.

Features

- Single pole thermal circuit breaker/switch combination
- Voltage rating: AC 250 V, DC 50 V
- Current ratings: 0.05...16 A
- Approvals: VDE, UL, CSA
- Accessories: Plastic cap to protect against dust and water in actuator and terminal area (IP64)



Your benefits

- Cost and space savings because one component unites the functions of ON/OFF switch and overload protection
- Time savings through quick trouble-shooting and fast and easy reset by push button
- Maximum machine and equipment uptime through perfectly matched overload protection protection and quick reset

Preferred types – for more details on all configurations please see order numbering code

Preferred types are E-T-A products most frequently used by E-T-A customers. We manufacture E-T-A preferred types in particularly high volumes.

Preferred types	Short description	Preferred ratings (A)							
		1	2	3	5	6	8	10	16
1110-F112-P1M1-	panel thickness 0.8...1.6 mm	•	•	•	•	•	•	•	•
1110-F212-P1M1-	panel thickness 1.8...3 mm	•	•	•	•	•	•	•	•

Approvals



Conformities



Technical data

For further details please see: www.e-t-a.de/ti_e

Voltage rating	AC 250 V; DC 50 V		
Current rating	0.05...16 A		
I_n	operations	U_n	I
0.05...10 A	10000	AC 250 V	1xI _n
0.05...10 A	10000	DC 28 V	1xI _n
0.05...10 A	6000	DC 50 V	1xI _n
12...16 A	2000	DC 50 V	1xI _n
Ambient temperature	-20...60 °C (-4...+140 °F)		
Insulation co-ordination (IEC 60664)	2.5 kV/2 reinforced insulation in operating area		
Dielectric strength	operating area test voltage AC 3 000 V		
Insulation resistance	> 100 MΩ (DC 500 V)		
Interrupting capacity I _{cn}	AC 250 V:	0.05...10 A	8 x I _N
	DC 50 V:	0.05...6 A	10 x I _N
		7...16 A	130 A
	DC 28 V:	7...10 A	200 A

Technical data

Interrupting capacity (UL 1077)	I_N	U_N	
	0.05...6 A	AC 250V	1 000 A, C, 1
	7...16 A	AC 125V	1 000 A, U, 1
	0.05...16 A	DC 50V	1 000 A, C, 1
Degree of protection (IEC 60529)			
operating area	IP40		
terminal area	with protective cover IP64 IP00 with protective cover IP64		
Vibration	8 g (57-500 Hz) ± 0.61 mm (10-57 Hz), to IEC 60068-2-6, test Fc, 10 frequency cycles/axis		
Shock	30 g (11 ms) to IEC 60068-2-27, test Ea		
Corrosion	96 hours at 5 % salt mist, to IEC 60068-2-11, test Ka		
Humidity	240 hours at 95 % RH to IEC 60068-2-78, test Cab		
Mass	approx. 12 g		

Preferred types

Preferred types are E-T-A products most frequently used by E-T-A customers. We manufacture E-T-A preferred types in particularly high volumes.

Preferred types	Short description	Preferred ratings (A)							
		1	2	3	5	6	8	10	16
1110-F112-P1M1-	panel thickness 0.8...1.6 mm	•	•	•	•	•	•	•	•
1110-F212-P1M1-	panel thickness 1.8...3 mm	•	•	•	•	•	•	•	•

Ordering information

Type No.	1110 snap in panel mounting
Mounting	
F1	panel thickness 0.8...1.6 mm (.031 -.063 in)
F2	panel thickness 1.8...3 mm (.071-.118 in)
Number of poles	
1	1-pole protected
Actuator style	
2	black push button/white indicator ring, push-push function
Terminal design	
P1	blade terminals A6.3-0.8 (QC .250)
Characteristic curve	
M1	medium delay
Current ratings	
	0.05...16A
1110 - F1 1 2 - P1 M1 - 0.05 A = ordering example	

Please be informed that we have minimum ordering quantities to be observed.

Custom designed versions

Looking for a version you cannot find in our ordering number code? Please get in touch. We will be pleased to find a solution for you.

Standard current ratings and typical internal resistance values

Current rating (A)	Internal resistance (Ω)	Current rating (A)	Internal resistance (Ω)
0.05	442	2.5	0.19
0.1	110	3	0.12
0.2	27.8	3.5	0.09
0.3	12.4	4	0.07
0.4	7.0	5	0.05
0.5	4.5	6	0.04
0.6	3.1	7	≤ 0.02
0.7	2.3	8	≤ 0.02
1	1.1	10	≤ 0.02
1.5	0.41	12	≤ 0.02
1.8	0.38	15	≤ 0.02
2	0.25	16	≤ 0.02

This is a metric design and millimeter dimensions take precedence ($\frac{\text{mm}}{\text{inch}}$)

All dimensions without tolerances are for reference only. In the interest of improved design, performance and cost effectiveness the right to make changes in these specifications without notice is reserved. Product markings may not be exactly as the ordering codes. Errors and omissions excepted.

Approvals

Authority	Standard	Rated voltage	Current ratings	Approval logo
VDE	IEC/EN 60934	AC 250 V DC 50 V	0.05 A...10 A 0.05 A...16 A	
UL*	UL 1077 C22.2 No 235	AC 250 V AC 125 V DC 50 V	0.05 A...6 A 7 A...16 A 0.05 A...16 A	
CSA*	C22.2 No 235	AC 250 V AC 125 V DC 50 V	0.05 A...6 A 7 A...16 A 0.05 A...16 A	

*TC1, OLO

Dimensions

1110-F1.. / -F2..

When installing the circuit breaker apply pressure on bezel only.

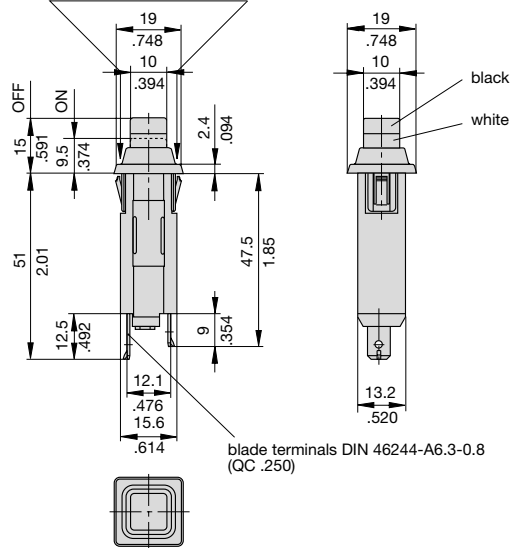

Panel cut out 1110-F1...-P1M1...A

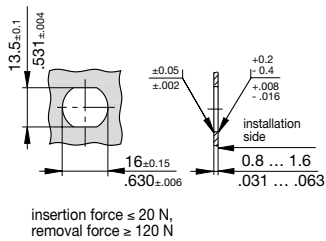

1110-F2...-P1M1...A

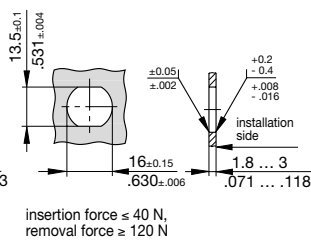

Installation drawing

When installing the circuit breaker apply pressure on bezel only.

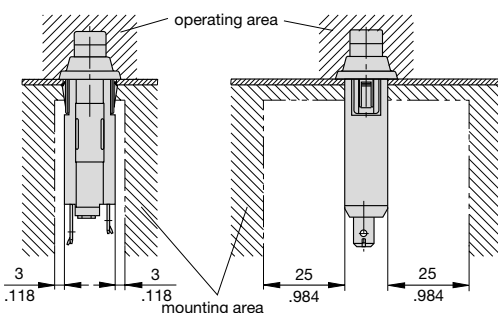

Internal connection diagram

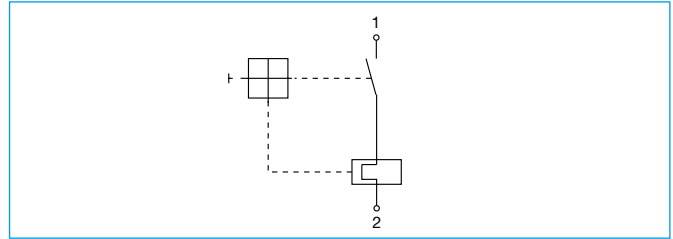

Typical time/current characteristics at +23 °C/+73.4 °F

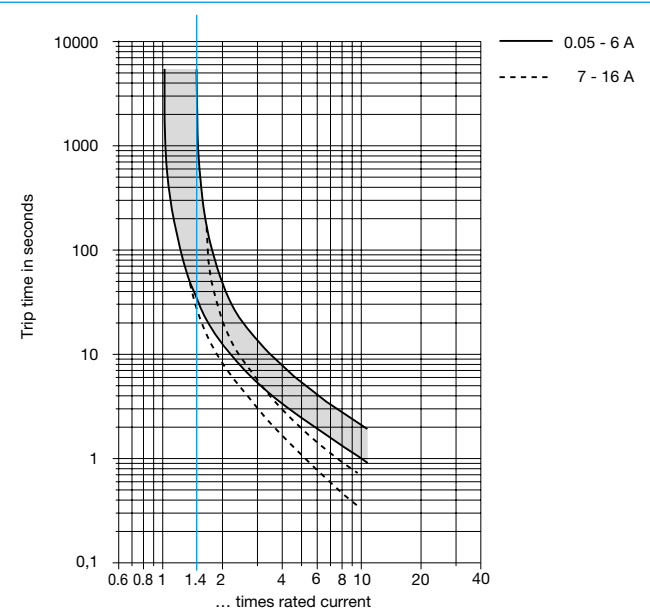

The time/current characteristic curve depends on the ambient temperature prevailing. In order to eliminate nuisance tripping, please multiply the circuit breaker current ratings by the derating factor shown below.

Ambient temperature °F	-4	+14	+32	+73.4	+104	+122	+140
°C	-20	-10	0	+23	+40	+50	+60
Derating factor	0.76	0.84	0.92	1	1.08	1.16	1.24

Accessories – Water splash covers (transparent)

Push button splash cover transparent Y 304 745 01 (IP64)

When using splash cover please note that the max. panel thickness is reduced by 0.5 mm/0.02 in.

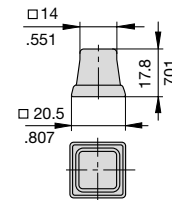

Terminal shroud Y 305 602 01 (IP64)

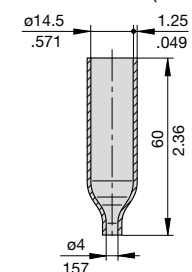



Компания «ЭлектроПласт» предлагает заключение долгосрочных отношений при поставках импортных электронных компонентов на взаимовыгодных условиях!

Наши преимущества:

- Оперативные поставки широкого спектра электронных компонентов отечественного и импортного производства напрямую от производителей и с крупнейших мировых складов;
- Поставка более 17-ти миллионов наименований электронных компонентов;
- Поставка сложных, дефицитных, либо снятых с производства позиций;
- Оперативные сроки поставки под заказ (от 5 рабочих дней);
- Экспресс доставка в любую точку России;
- Техническая поддержка проекта, помощь в подборе аналогов, поставка прототипов;
- Система менеджмента качества сертифицирована по Международному стандарту ISO 9001;
- Лицензия ФСБ на осуществление работ с использованием сведений, составляющих государственную тайну;
- Поставка специализированных компонентов (Xilinx, Altera, Analog Devices, Intersil, Interpoint, Microsemi, Aeroflex, Peregrine, Syfer, Eurofarad, Texas Instrument, Miteq, Cobham, E2V, MA-COM, Hittite, Mini-Circuits, General Dynamics и др.);

Помимо этого, одним из направлений компании «ЭлектроПласт» является направление «Источники питания». Мы предлагаем Вам помощь Конструкторского отдела:

- Подбор оптимального решения, техническое обоснование при выборе компонента;
- Подбор аналогов;
- Консультации по применению компонента;
- Поставка образцов и прототипов;
- Техническая поддержка проекта;
- Защита от снятия компонента с производства.



Как с нами связаться

Телефон: 8 (812) 309 58 32 (многоканальный)

Факс: 8 (812) 320-02-42

Электронная почта: org@eplast1.ru

Адрес: 198099, г. Санкт-Петербург, ул. Калинина, дом 2, корпус 4, литера А.