

1.0 A Slew Rate Controlled Load Switch with Reverse Blocking in SC70-6, and TDFN4 1.2 mm x 1.6 mm

DESCRIPTION

The SiP32431 is a slew rate controlled high side switch with reverse blocking capability. The switch is of a low ON resistance p-channel MOSFET that supports continuous current up to 1.0 A.

The SiP32431 operates with an input voltage from 1.5 V to 5.5 V.

The SiP32431 features low input logic level to interface with low control voltage from microprocessors. This device has a very low operating current, typically 50 pA.

The SiP32431 is available in lead (Pb)-free package options including 6 pin SC70-6, and 4 pin TDFN4 1.2 mm x 1.6 mm DFN4 packages. The operation temperature range is specified from - 40 °C to + 85 °C.

The SiP32431 compact package options, operation voltage range, and low operating current make it a good fit for battery power applications.

FEATURES

- 1.5 V to 5.5 V input voltage range
- Very low $R_{DS(on)}$, typically 105 mΩ at 5 V and 135 mΩ at 3 V for TDFN4 1.2 mm x 1.6 mm package
- Typical 147 mΩ at 5 V and 178 mΩ at 3 V for SC70-6 package
- Slew rate controlled turn-on time: 100 μs
- Low quiescent current < 1 μA
- Low shutdown current < 1 μA
- Reverse blocking capability
- SC70-6 and TDFN4 1.2 mm x 1.6 mm packages
- **Compliant to RoHS Directive 2002/95/EC**
- **Halogen-free according to IEC 61249-2-21 definition**



RoHS
COMPLIANT
HALOGEN
FREE
Available

APPLICATIONS

- Cellular telephones
- Digital still cameras
- Personal digital assistants (PDA)
- Hot swap supplies
- Notebook computers
- Personal communication devices
- Portable Instruments

TYPICAL APPLICATION CIRCUIT

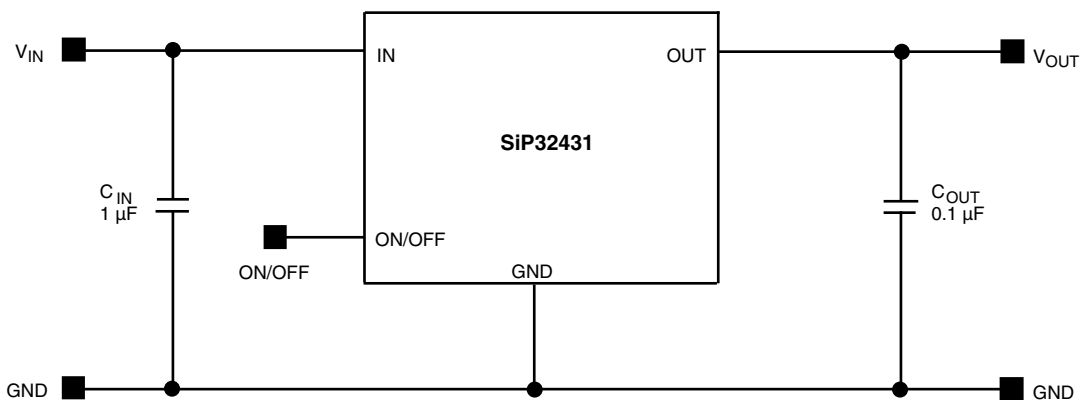

Figure 1 - SiP32431 Typical Application Circuit

ORDERING INFORMATION

Temperature Range	Package	Marking	Part Number
- 40 °C to 85 °C	SC70-6	MAxx	SiP32431DR3-T1GE3
	TDFN4 1.2 mm x 1.6 mm	ADx	SiP32431DNP3-T1GE4

Notes:

x = Lot Code

-GE3 denotes halogen-free and RoHS compliant

Please use the SiP32431DR3-T1GE3 to replace SiP32431DR3-T1-E3

ABSOLUTE MAXIMUM RATINGS

Parameter		Limit	Unit
Supply Input Voltage (V_{IN})		- 0.3 to 6	V
Enable Input Voltage ($V_{ON/OFF}$)		- 0.3 to 6	
Output Voltage (V_{OUT})		- 0.3 to $V_{IN} + 0.3$	
Maximum Continuous Switch Current (I_{MAX})	SC70-6 package	1.2	A
	TDFN4 1.2 mm x 1.6 mm	1.4	
Maximum Pulsed Current (I_{DM}) V_{IN} (Pulsed at 1 ms, 10 % Duty Cycle)	$V_{IN} \geq 2.5$ V	3	
	$V_{IN} < 2.5$ V	1.6	
ESD Rating (HBM)		4000	V
Junction Temperature (T_J)		- 40 to 125	°C
Thermal Resistance (θ_{JA}) ^a	6 pin SC70-6 ^b	220	°C/W
	4 pin TDFN4 1.2 mm x 1.6 mm ^c	170	
Power Dissipation (P_D) ^a	6 pin SC70-6 ^b	250	mW
	4 pin TDFN4 1.2 mm x 1.6 mm ^c	324	

Notes:

a. Device mounted with all leads and power pad soldered or welded to PC board.

b. Derate 4.5 mW/°C above $T_A = 70$ °C.c. Derate 5.9 mW/°C above $T_A = 70$ °C, see PCB layout.

Stresses beyond those listed under "Absolute Maximum Ratings" may cause permanent damage to the device. These are stress ratings only, and functional operation of the device at these or any other conditions beyond those indicated in the operational sections of the specifications is not implied. Exposure to absolute maximum rating/conditions for extended periods may affect device reliability.

RECOMMENDED OPERATING RANGE

Parameter	Limit	Unit
Input Voltage Range (V_{IN})	1.5 to 5.5	V
Operating Temperature Range	- 40 to 85	°C

SPECIFICATIONS						
Parameter	Symbol	Test Conditions Unless Specified $V_{IN} = 5.0$, $T_A = -40\text{ }^\circ\text{C}$ to $85\text{ }^\circ\text{C}$ (Typical values are at $T_A = 25\text{ }^\circ\text{C}$)	Limits - $40\text{ }^\circ\text{C}$ to $85\text{ }^\circ\text{C}$			Unit
			Min. ^a	Typ. ^b	Max. ^a	
Operating Voltage ^c	V_{IN}		1.5	-	5.5	V
Quiescent Current	I_Q	On/Off = active	-	0.00005	1	μA
Off Supply Current	$I_{Q(off)}$	On/Off = inactive, Out = open	-	-	1	
Off Switch Current	$I_{SD(off)}$	On/Off = inactive, Out = 0	-	-	1	
Reverse Blocking Current	I_{RB}	$V_{OUT} = 5.5\text{ V}$, $V_{IN} = 0$, $V_{on/off} = \text{inactive}$	-	0.13	1	
On-Resistance	$R_{DS(on)}$	$V_{IN} = 5\text{ V}$, $I_L = 500\text{ mA}$, $T_A = 25\text{ }^\circ\text{C}$	SC70-6	-	147	230
			TDFN4	-	105	
		$V_{IN} = 4.2\text{ V}$, $I_L = 500\text{ mA}$, $T_A = 25\text{ }^\circ\text{C}$	SC70-6	-	155	250
			TDFN4	-	110	
		$V_{IN} = 3\text{ V}$, $I_L = 500\text{ mA}$, $T_A = 25\text{ }^\circ\text{C}$	SC70-6	-	178	290
			TDFN4	-	135	
		$V_{IN} = 1.8\text{ V}$, $I_L = 500\text{ mA}$, $T_A = 25\text{ }^\circ\text{C}$	SC70-6	-	275	480
			TDFN4	-	230	
		$V_{IN} = 1.5\text{ V}$, $I_L = 500\text{ mA}$, $T_A = 25\text{ }^\circ\text{C}$	SC70-6	-	395	520
			TDFN4	-	350	
On-Resistance Temp.-Coefficient	TD_{RDS}		-	2800	-	ppm/ $^\circ\text{C}$
On/Off Input Low Voltage ^c	V_{IL}	$V_{IN} \geq 1.5\text{ V}$ to $< 1.8\text{ V}$	-	-	0.3	V
		$V_{IN} \geq 1.8\text{ V}$ to $< 2.7\text{ V}$	-	-	0.4	
		$V_{IN} \geq 2.7\text{ V}$ to $\leq 5.5\text{ V}$	-	-	0.6	
On/Off Input Low Voltage ^c	V_{IH}	$V_{IN} \geq 1.5\text{ V}$ to $< 2.7\text{ V}$	1.3	-	-	
		$V_{IN} \geq 2.7\text{ V}$ to $< 4.2\text{ V}$	1.5	-	-	
		$V_{IN} \geq 4.2\text{ V}$ to $\leq 5.5\text{ V}$	1.8	-	-	
On/Off Input Leakage	I_{SINK}	$V_{On/Off} = 5.5\text{ V}$	-	-	1	μA
Output Turn-On Delay Time	$t_{d(on)}$	$V_{IN} = 5\text{ V}$, $R_{LOAD} = 10\ \Omega$, $T_A = 25\text{ }^\circ\text{C}$	-	20	40	μs
Output Turn-On Rise Time	$t_{(on)}$		-	140	180	
Output Turn-Off Delay Time	$t_{d(off)}$		-	4	10	

Notes:

- a. The algebraic convention whereby the most negative value is a minimum and the most positive a maximum.
- b. Typical values are for DESIGN AID ONLY, not guaranteed nor subject to production testing
- c. For V_{IN} outside this range consult typical ON/OFF threshold curve.

PIN CONFIGURATION

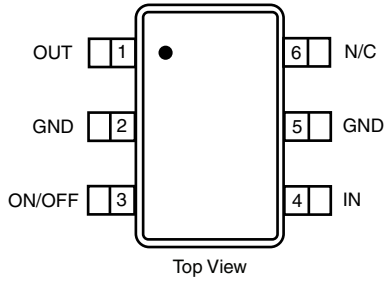

Figure 2 - SC70-6 Package

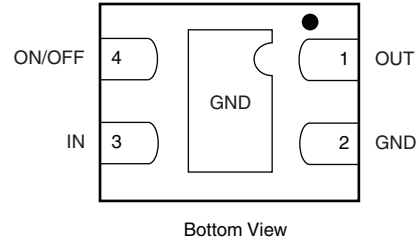

Figure 3 - TDFN4 1.2 mm x 1.6 mm Package

PIN DESCRIPTION

Pin Number		Name	Function
SC70-6	TDFN4		
4	3	IN	This pin is the p-channel MOSFET source connection. Bypass to ground through a 1 μ F capacitor.
2, 5	2	GND	Ground connection
3	4	ON/OFF	Enable input
1	1	OUT	This pin is the p-channel MOSFET drain connection. Bypass to ground through a 0.1 μ F capacitor.

TYPICAL CHARACTERISTICS (internally regulated, 25 °C, unless otherwise noted)

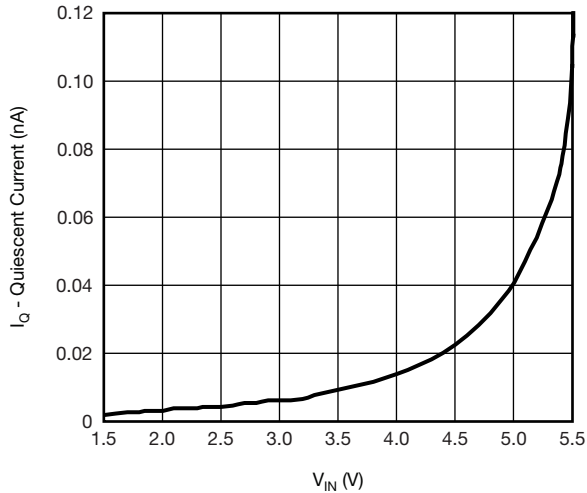

Figure 4 - Quiescent Current vs. Input Voltage

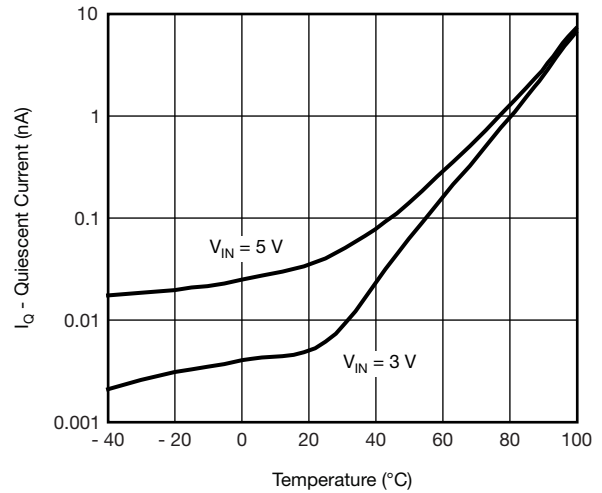

Figure 5 - Quiescent Current vs. Temperature

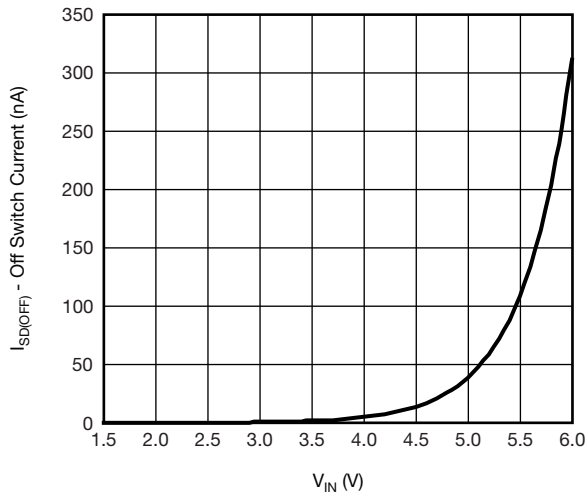

Figure 6 - Off Switch Current vs. Input Voltage

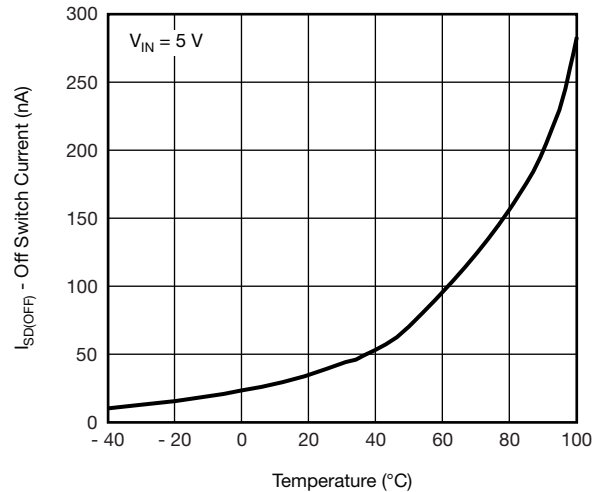

Figure 7 - Off Switch Current vs. Temperature

TYPICAL CHARACTERISTICS (internally regulated, 25 °C, unless otherwise noted)

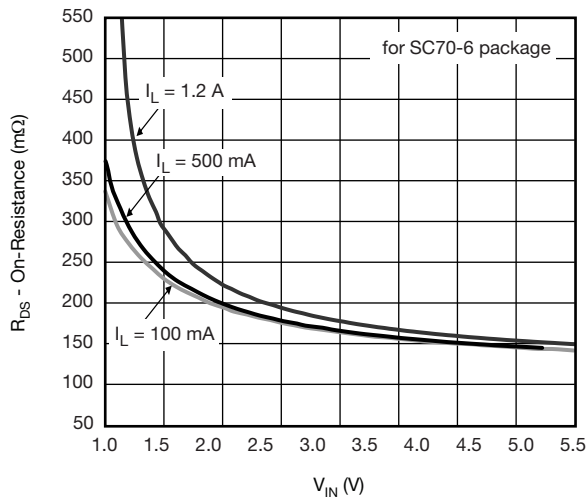

Figure 8 - $R_{DS(on)}$ vs. V_{IN} for SC70-6 Package

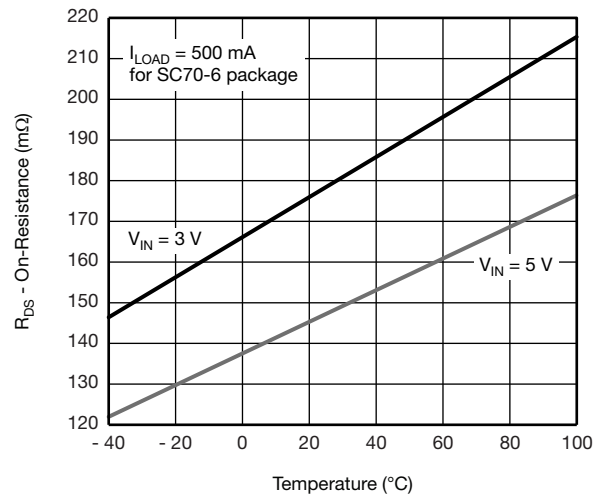

Figure 9 - $R_{DS(on)}$ vs. Temperature

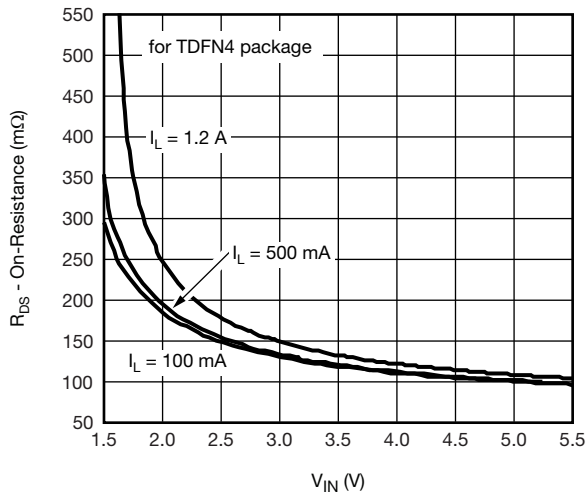

Figure 10 - $R_{DS(on)}$ vs. Input Voltage

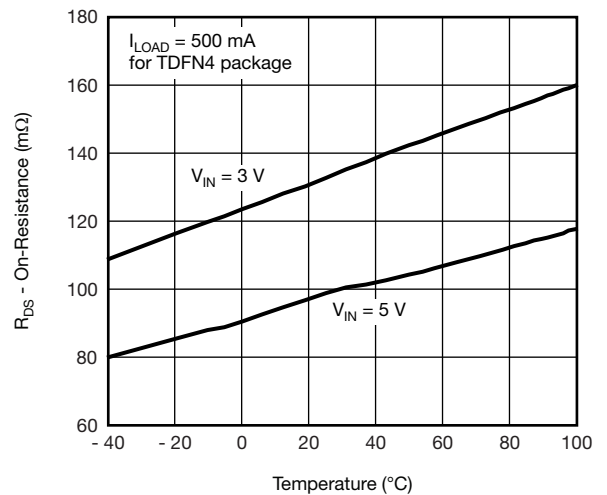

Figure 11 - $R_{DS(on)}$ vs. Temperature

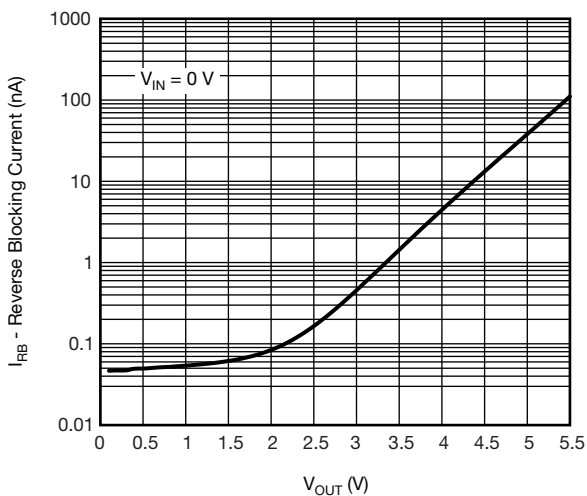

Figure 12 - Reverse Blocking Current vs. V_{OUT}

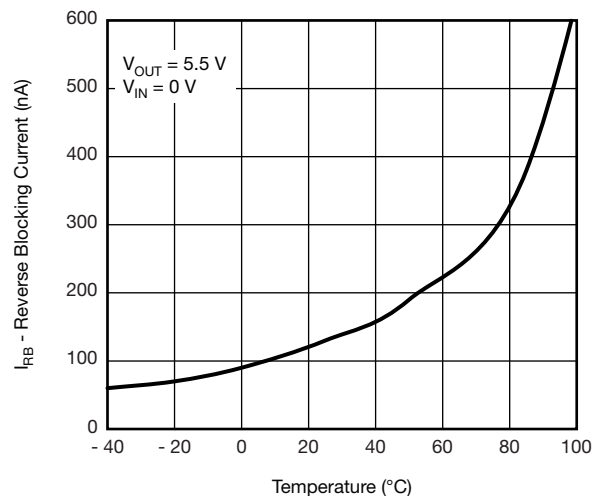

Figure 13 - Reverse Blocking Current vs. Temperature

TYPICAL CHARACTERISTICS (internally regulated, 25 °C, unless otherwise noted)

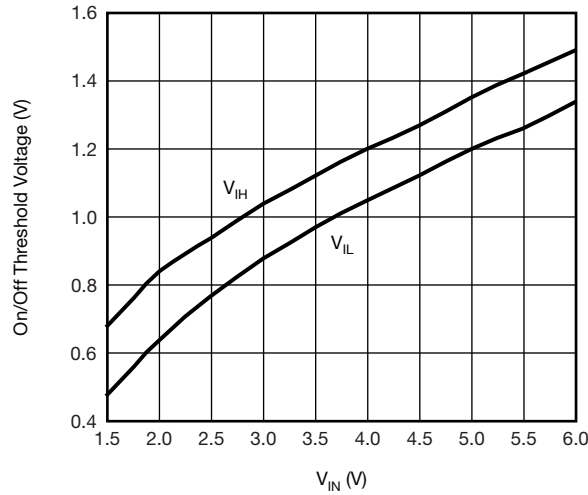

Figure 14 - ON/OFF Threshold vs. Input Voltage

TYPICAL WAVEFORMS

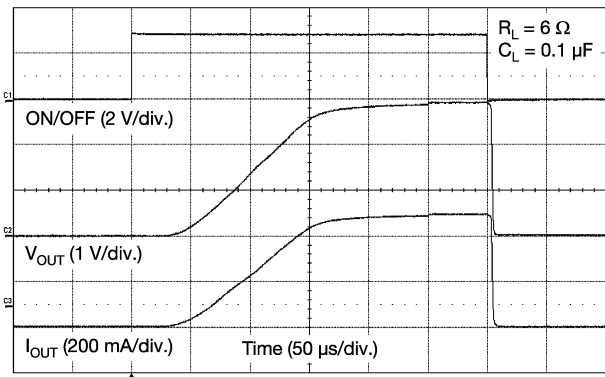

Figure 15 - Switching ($V_{IN} = 3\text{ V}$)

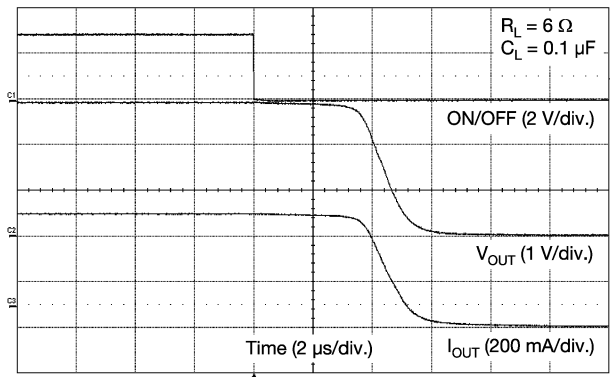

Figure 16 - Turn-Off ($V_{IN} = 3\text{ V}$)

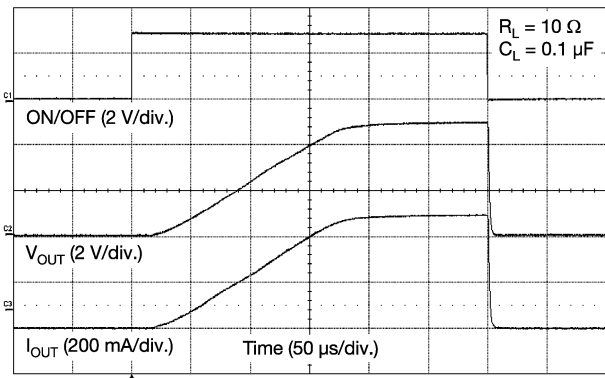

Figure 17 - Switching ($V_{IN} = 5\text{ V}$)

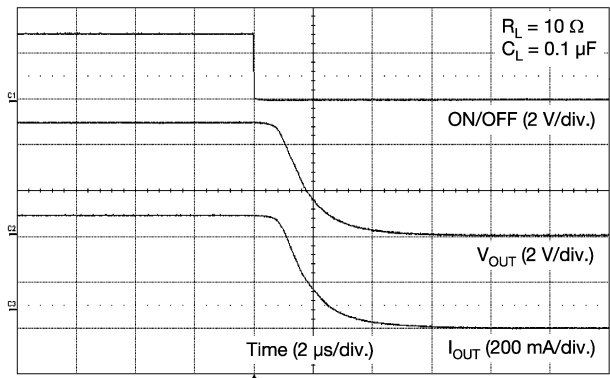

Figure 18 - Turn-Off ($V_{IN} = 5\text{ V}$)

BLOCK DIAGRAM

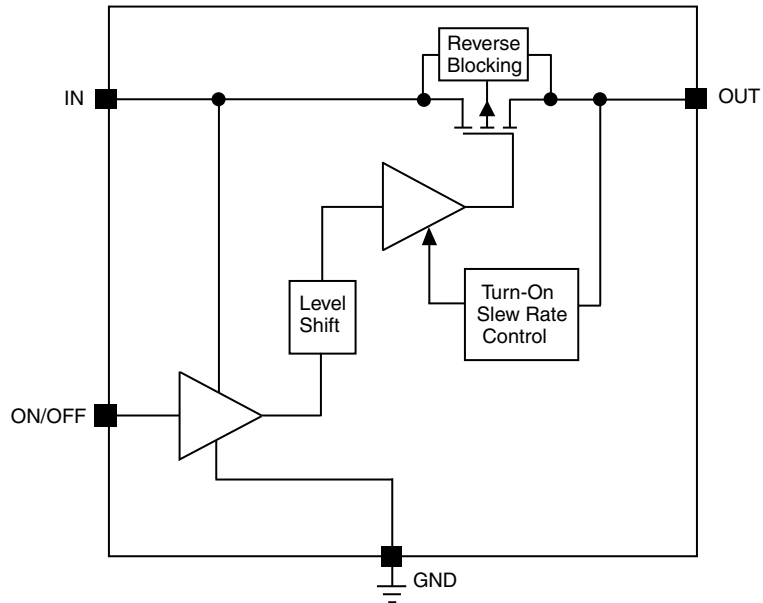

Figure 19 - Functional Block Diagram

PCB LAYOUT

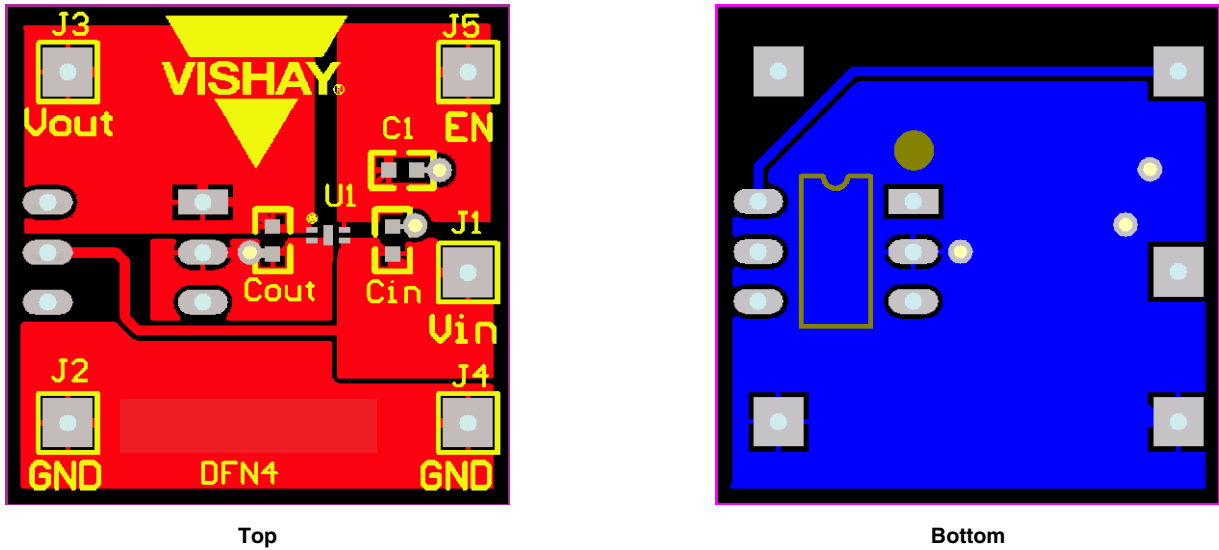

Figure 20 - TDFN4 1.2 mm x 1.6 mm PCB Layout

DETAILED DESCRIPTION

The SiP32431 is a P-Channel MOSFET power switches designed for high-side slew rate controlled load-switching applications. Once turned on, the slew-rate control circuitry is activated and current is ramped in a linear fashion until it reaches the level required for the output load condition. This is accomplished by first elevating the gate voltage of the MOSFET up to its threshold voltage and then by linearly increasing the gate voltage until the MOSFET becomes fully enhanced. At this point, the gate voltage is then quickly increased to the full input voltage to reduce $R_{DS(on)}$ of the MOSFET switch and minimize any associated power losses.

APPLICATION INFORMATION

Input Capacitor

While a bypass capacitor on the input is not required, a 1 μF or larger capacitor for C_{IN} is recommended in almost all applications. The bypass capacitor should be placed as physically close as possible to the SiP32431 to be effective in minimizing transients on the input. Ceramic capacitors are recommended over tantalum because of their ability to withstand input current surges from low impedance sources such as batteries in portable devices.

Output Capacitor

A 0.1 μF capacitor or larger across V_{OUT} and GND is recommended to insure proper slew operation. C_{OUT} may be increased without limit to accommodate any load transient condition with only minimal affect on the SiP32431 turn on slew rate time. There are no ESR or capacitor type requirement.

Enable

The On/Off pin is compatible with both TTL and CMOS logic voltage levels.

Protection Against Reverse Voltage Condition

The SiP32431 contains a body snatcher that normally connect the body to the Source (IN) when the device is enable. In case where the device is disabled but the V_{OUT} is higher than the V_{IN} , the n-type body is switched to OUT, reverse bias the body diode to prevent the current from going back to the input.

Thermal Considerations

The SiP32431 is designed to maintain a constant output load current. Due to physical limitations of the layout and assembly of the device the maximum switch current is 1.0 A, as stated in the Absolute Maximum Ratings table. However, another limiting characteristic for the safe operating load current is the thermal power dissipation of the package. To obtain the highest power dissipation (and a thermal resistance of 170 $^{\circ}\text{C}/\text{W}$) the power pad of the device should be connected to a heat sink on the printed circuit board.

The maximum power dissipation in any application is dependant on the maximum junction temperature, $T_{J(MAX)} = 125^{\circ}\text{C}$, the junction-to-ambient thermal resistance for the TDFN4 1.2 mm x 1.6 mm package, $\theta_{J-A} = 170^{\circ}\text{C}/\text{W}$, and the ambient temperature, T_A , which may be formulaically expressed as:

$$P(\text{max.}) = \frac{T_J(\text{max.}) - T_A}{\theta_{J-A}} = \frac{125 - T_A}{170}$$

It then follows that, assuming an ambient temperature of 70 $^{\circ}\text{C}$, the maximum power dissipation will be limited to about 324 mW.

So long as the load current is below the 1.0 A limit, the maximum continuous switch current becomes a function two things: the package power dissipation and the $R_{DS(on)}$ at the ambient temperature.

As an example let us calculate the worst case maximum load current at $T_A = 70^{\circ}\text{C}$. The worst case $R_{DS(on)}$ at 25 $^{\circ}\text{C}$ occurs at an input voltage of 1.5 V and is equal to 520 m Ω . The $R_{DS(on)}$ at 70 $^{\circ}\text{C}$ can be extrapolated from this data using the following formula

$$R_{DS(on)}(\text{at } 70^{\circ}\text{C}) = R_{DS(on)}(\text{at } 25^{\circ}\text{C}) \times (1 + T_C \times \Delta T)$$

Where T_C is 3300 ppm/ $^{\circ}\text{C}$. Continuing with the calculation we have

$$R_{DS(on)}(\text{at } 70^{\circ}\text{C}) = 520 \text{ m}\Omega \times (1 + 0.0033 \times (70^{\circ}\text{C} - 25^{\circ}\text{C})) = 597 \text{ m}\Omega$$

The maximum current limit is then determined by

$$I_{LOAD}(\text{max.}) < \sqrt{\frac{P(\text{max.})}{R_{DS(on)}}}$$

which in case is 0.74 A. Under the stated input voltage condition, if the 0.74 A current limit is exceeded the internal die temperature will rise and eventually, possibly damage the device.



TDFN4 1.2 x 1.6 Case Outline

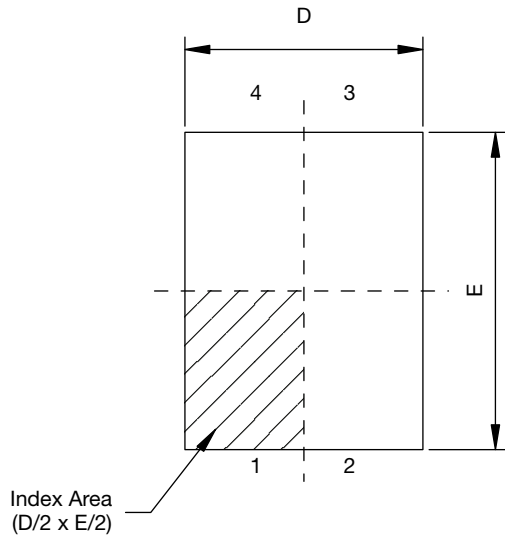

Top View

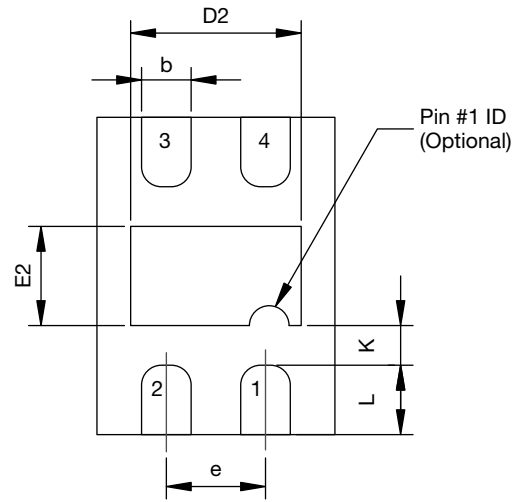

Bottom View

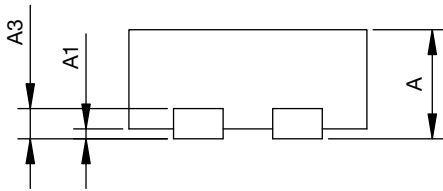

Side View

DIM.	MILLIMETERS			INCHES		
	MIN.	NOM.	MAX.	MIN.	NOM.	MAX.
A	0.50	0.55	0.60	0.020	0.022	0.024
A1	0.00	-	0.05	0.00	-	0.002
A3	0.15 REF.			0.006		
b	0.20	0.25	0.30	0.008	0.010	0.012
D	1.15	1.20	1.25	0.045	0.047	0.049
D2	0.81	0.86	0.91	0.032	0.034	0.036
e	0.50 BSC			0.020		
E	1.55	1.60	1.65	0.061	0.063	0.065
E2	0.45	0.50	0.55	0.018	0.020	0.022
K	0.25 TYP.			0.010 TYP.		
L	0.25	0.30	0.35	0.010	0.012	0.014
ECN: S11-2099-Rev. B, 07-Nov-11						
DWG: 5995						

SC-70: 3/4/5/6-LEADS (PIC ONLY)

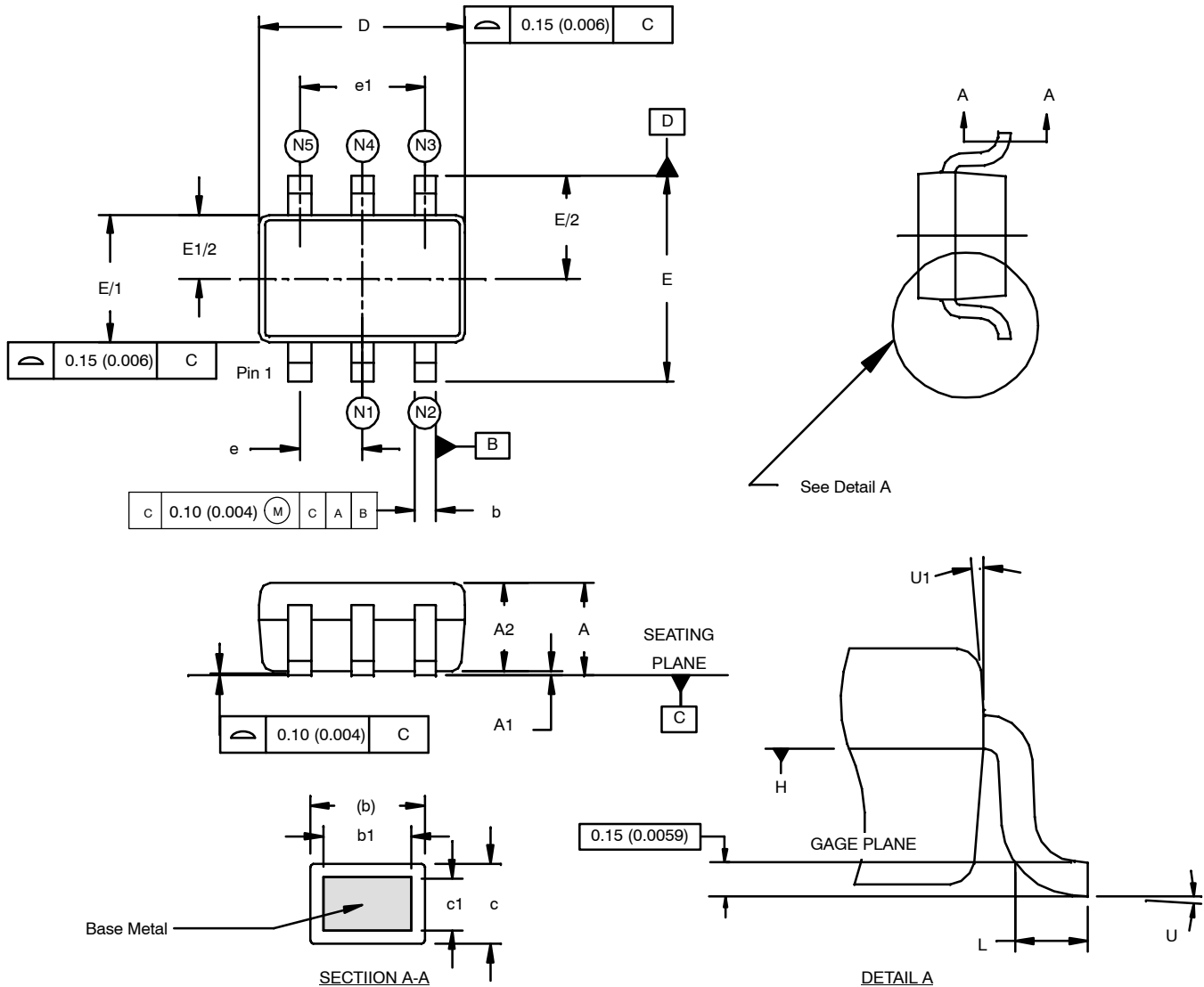

Pin Code	LEAD COUNT			
	3	4	5	6
N1	-	-	2	2
N2	2	2	3	3
N3	-	3	4	4
N4	3	-	-	5
N5	-	4	5	6

NOTES:

1. Dimensioning and tolerancing per ANSI Y14.5M-1994.
2. Controlling dimensions: millimeters converted to inch dimensions are not necessarily exact.
3. Dimension "D" does not include mold flash, protrusion or gate burr. Mold flash, protrusion or gate burr shall not exceed 0.15 mm (0.006 inch) per side.
4. The package top shall be smaller than the package bottom. Dimension "D" and "E1" are determined at the outer most extremes of the plastic body exclusive of mold flash, tie bar burrs, gate burrs and interlead flash, but including any mismatch between the top and bottom of the plastic body.



Dim	MILLIMETERS			INCHES		
	Min	Nom	Max	Min	Nom	Max
A	0.80	–	1.10	0.031	–	0.043
A1	0.00	–	0.10	0.000	–	0.004
A2	0.80	0.90	1.00	0.031	0.035	0.040
b	0.15	–	0.30	0.006	–	0.012
b1	0.15	0.20	0.25	0.006	0.008	0.010
c	0.08	–	0.25	0.003	–	0.010
c1	0.08	0.13	0.20	0.003	0.005	0.008
D	1.90	2.10	2.15	0.074	0.082	0.084
E	2.00	2.10	2.20	0.078	0.082	0.086
E₁	1.15	1.25	1.35	0.045	0.050	0.055
e	0.65 BSC			0.0255 BSC		
e₁	1.30 BSC			0.0512 BSC		
L	0.26	0.36	0.46	0.010	0.014	0.018
U	0°	–	8°	0°	–	8°
U1	4°		10°	4°		10°
ECN: S-42145—Rev. A, 22-Nov-04 DWG: 5941						

RECOMMENDED MINIMUM PADS FOR TDFN4 1.2 x 1.6

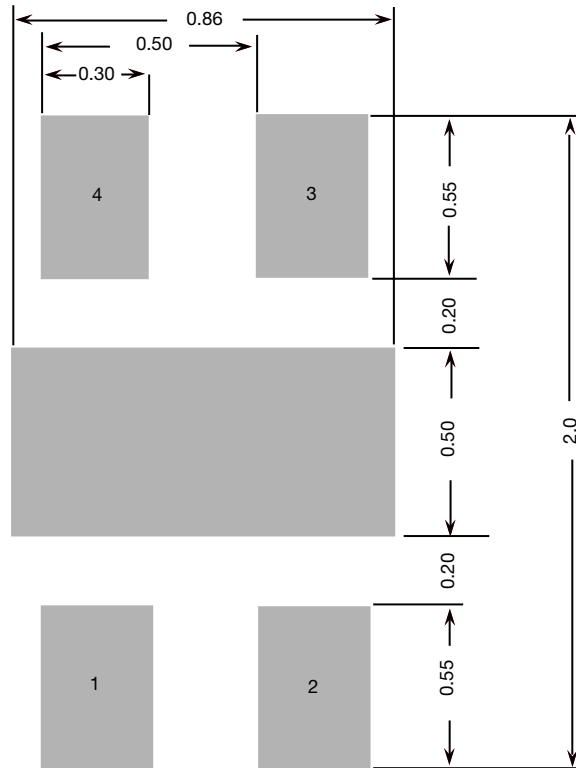

Recommended Minimum Pads
Dimensions in mm



Disclaimer

ALL PRODUCT, PRODUCT SPECIFICATIONS AND DATA ARE SUBJECT TO CHANGE WITHOUT NOTICE TO IMPROVE RELIABILITY, FUNCTION OR DESIGN OR OTHERWISE.

Vishay Intertechnology, Inc., its affiliates, agents, and employees, and all persons acting on its or their behalf (collectively, "Vishay"), disclaim any and all liability for any errors, inaccuracies or incompleteness contained in any datasheet or in any other disclosure relating to any product.

Vishay makes no warranty, representation or guarantee regarding the suitability of the products for any particular purpose or the continuing production of any product. To the maximum extent permitted by applicable law, Vishay disclaims (i) any and all liability arising out of the application or use of any product, (ii) any and all liability, including without limitation special, consequential or incidental damages, and (iii) any and all implied warranties, including warranties of fitness for particular purpose, non-infringement and merchantability.

Statements regarding the suitability of products for certain types of applications are based on Vishay's knowledge of typical requirements that are often placed on Vishay products in generic applications. Such statements are not binding statements about the suitability of products for a particular application. It is the customer's responsibility to validate that a particular product with the properties described in the product specification is suitable for use in a particular application. Parameters provided in datasheets and/or specifications may vary in different applications and performance may vary over time. All operating parameters, including typical parameters, must be validated for each customer application by the customer's technical experts. Product specifications do not expand or otherwise modify Vishay's terms and conditions of purchase, including but not limited to the warranty expressed therein.

Except as expressly indicated in writing, Vishay products are not designed for use in medical, life-saving, or life-sustaining applications or for any other application in which the failure of the Vishay product could result in personal injury or death. Customers using or selling Vishay products not expressly indicated for use in such applications do so at their own risk. Please contact authorized Vishay personnel to obtain written terms and conditions regarding products designed for such applications.

No license, express or implied, by estoppel or otherwise, to any intellectual property rights is granted by this document or by any conduct of Vishay. Product names and markings noted herein may be trademarks of their respective owners.

Material Category Policy

Vishay Intertechnology, Inc. hereby certifies that all its products that are identified as RoHS-Compliant fulfill the definitions and restrictions defined under Directive 2011/65/EU of The European Parliament and of the Council of June 8, 2011 on the restriction of the use of certain hazardous substances in electrical and electronic equipment (EEE) - recast, unless otherwise specified as non-compliant.

Please note that some Vishay documentation may still make reference to RoHS Directive 2002/95/EC. We confirm that all the products identified as being compliant to Directive 2002/95/EC conform to Directive 2011/65/EU.

Vishay Intertechnology, Inc. hereby certifies that all its products that are identified as Halogen-Free follow Halogen-Free requirements as per JEDEC JS709A standards. Please note that some Vishay documentation may still make reference to the IEC 61249-2-21 definition. We confirm that all the products identified as being compliant to IEC 61249-2-21 conform to JEDEC JS709A standards.



Компания «ЭлектроПласт» предлагает заключение долгосрочных отношений при поставках импортных электронных компонентов на взаимовыгодных условиях!

Наши преимущества:

- Оперативные поставки широкого спектра электронных компонентов отечественного и импортного производства напрямую от производителей и с крупнейших мировых складов;
- Поставка более 17-ти миллионов наименований электронных компонентов;
- Поставка сложных, дефицитных, либо снятых с производства позиций;
- Оперативные сроки поставки под заказ (от 5 рабочих дней);
- Экспресс доставка в любую точку России;
- Техническая поддержка проекта, помощь в подборе аналогов, поставка прототипов;
- Система менеджмента качества сертифицирована по Международному стандарту ISO 9001;
- Лицензия ФСБ на осуществление работ с использованием сведений, составляющих государственную тайну;
- Поставка специализированных компонентов (Xilinx, Altera, Analog Devices, Intersil, Interpoint, Microsemi, Aeroflex, Peregrine, Syfer, Eurofarad, Texas Instrument, Miteq, Cobham, E2V, MA-COM, Hittite, Mini-Circuits, General Dynamics и др.);

Помимо этого, одним из направлений компании «ЭлектроПласт» является направление «Источники питания». Мы предлагаем Вам помощь Конструкторского отдела:

- Подбор оптимального решения, техническое обоснование при выборе компонента;
- Подбор аналогов;
- Консультации по применению компонента;
- Поставка образцов и прототипов;
- Техническая поддержка проекта;
- Защита от снятия компонента с производства.



Как с нами связаться

Телефон: 8 (812) 309 58 32 (многоканальный)

Факс: 8 (812) 320-02-42

Электронная почта: org@eplast1.ru

Адрес: 198099, г. Санкт-Петербург, ул. Калинина, дом 2, корпус 4, литера А.