

6 POSITION SPEC Pak[®]

Sealed Power For Environmental Connections



Marine | Wind Power | Lighting | Transportation | Pumps | Ground Support
Machine Tool | Industrial Automation | Motor | Solar Power | Harsh Environments



APP
Anderson Power Products[®]

Rugged and Sealed (IP68) Plugs and Receptacles

For Use with APP® Powerpole® Signal, Power & Ground Contacts & Housings

APP's SPEC Pak® Connector Series uses rugged and environmentally sealed (IP68) shells to protect existing APP® Powerpole® contacts and housings. Customer configured SPEC Pak® Connectors may be used anywhere a rugged and waterproof high-power interconnect with signal and ground capabilities is required such as in; mass transportation, off-road vehicles, factory automation, oil and petrochemical exploration, agricultural equipment, and many more.

The core APP® Powerpole® technology within the SPEC Pak® is proven reliable and cost effective. The broad selection of touch safe, color-coded Powerpole® housings with power, signal and ground contacts accept a broad range of wire gauges, #24 to #10 AWG (0.25 to 4.0 mm²), giving users thousands of flexible design solutions in a single interconnect.

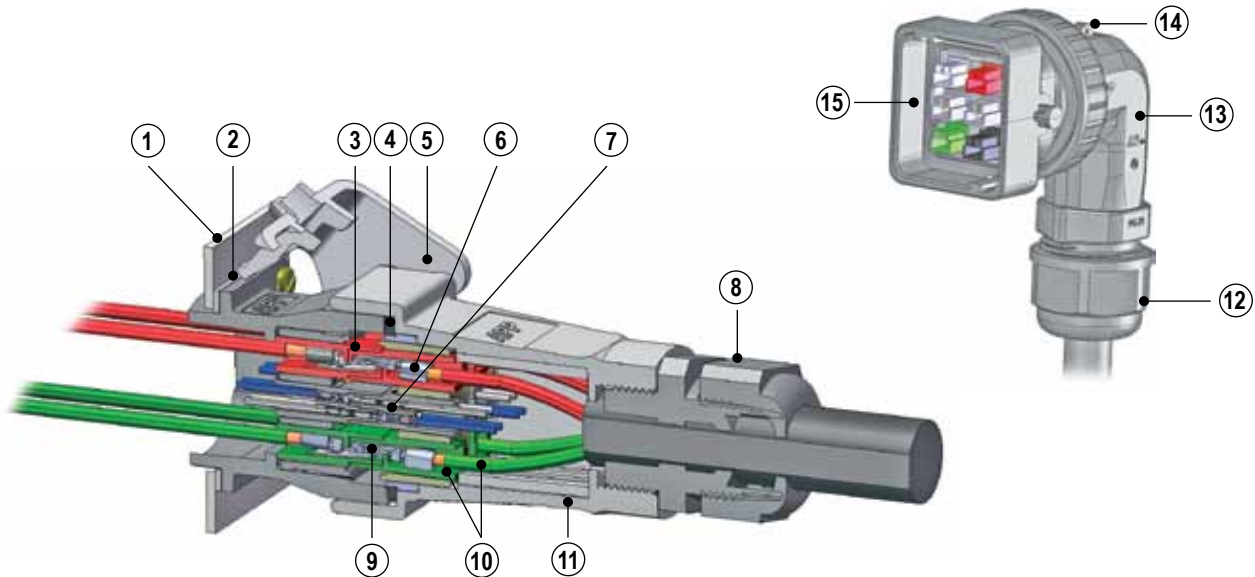

1 - Industry Standard Panel Cut Out

(Same as 26482 & 5015 shell size 24)

2 - IP68 Panel Mount Sealing Gasket

3 - Touch Safe Housings (UL1977, Section 10.2)

4 - IP68 Interfacial Sealing Gasket

5 - Latch (top or bottom of plug or receptacle)

6 - Power Contacts (up to 45 amps)

7 - Signal Contacts (4 contacts per PPMX housing)

8 - Uses Industry Standard Sealing Components

(PG gland compatible - size 21)

9 - First Mate / Last Break Ground Contacts

10 - Color Coded Housings to Match Wire Color

11 - UV & Chemical Resistant Ruggedized Shells

Additional Features Available on the Right Angle Include:

12 - Uses Industry Standard PG Gland

(PG gland compatible - size 21 or 29)

13 - Right Angle Backshell Lockable in 8 Directions for Cable Routing

14 - Integrated Strain Relief

15 - Ruggedized Right Angle Plug Shell

Specifications

SPEC Pak® Shell / Components

Electrical

UL Voltage Rating (AC/DC)	600
Dielectric Withstanding Voltage (AC)	3000
Operating Temperature (°C)	-40° to 105°
(°F)	-40° to 221°
Flammability Rating of SPEC Shells	UL 94V-0

Mechanical

Shells / Latch Mating Cycles	1500 Min
Connect / Disconnect (lbf)	18 Max
(N)	80 Max
IP Rating	IP68
UL50 Sec 30 Sealing Requirement	Pass

Material

Shells (Plug / Receptacle)	PBT
Latch	Nylon
Holder	Polycarbonate

PPMX (4800 Series) Powerpole® Signal Contact

Ratings for SPEC Pak® Use

Electrical

UL Current Rating (Amperes)	7
Voltage Rating (AC/DC)	300
Contact Barrel Wire Size (AWG)	#20 to #24
(mm ²)	0.5 to 0.25
Contact Retention Force (lbf)	12.0
(N)	53.0
Insertion Force (lbf)	4.5 Max
(N)	20.0 Max
Operating Temperature (°C)	-20° to 105°
(°F)	-4° to 221°

Mechanical

Mating Cycles (No load)	1500
-------------------------	------

Material

Housing Material	PBT
Contact Material	Copper Alloy
Contact Plating	Gold, 50 Micro-inches

NOTE: PPMX Contacts, up to 4 per housing

Powerpole® Power (1327FP Series) & Ground (1827 Series) Contacts

Ratings for SPEC Pak® Use

Electrical

UL Current Rating (Amperes)	15 to 45
CSA (30°C Rise) (Amperes)	10 to 29
Voltage Rating (AC/DC)	600
Contact Barrel Wire Size (AWG) - Power	20 to 10
- Ground	14 to 10
(mm ²) - Power	0.5 to 4.0
- Ground	1.5 to 4.0
Average Contact Resistance (micro-ohms)	600
Contact Retention Force (lbf)	25
(N)	111
Operating Temperature (°C)	-20° to 105°
(°F)	-4° to 221°
Flammability Rating	UL94 V-0

Mechanical

Mating Cycles	
No Load	
- Tin	1,500
- Silver	10,000
Under Load (Hot Plug 250 mating cycles @ 120V) *	30A
(Hot Plug 250 mating cycles @ 72V) *	45A
Mechanical Shock (50 g)	Mil Standard 202 213 Cond. A
Vibration (10 g)	Mil Standard 202 204 Cond. A

Material

Housing Material	Polycarbonate
Touch Safe (Power / Signal Housing)	UL1977 Sec. 10.2
Contact Material	Copper
Contact Plating	Tin or Silver

* Hot Plug testing completed with individual Powerpole® housings

NOTE: Agency approvals - TUV (contact customer service) / Patents

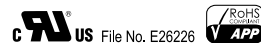

Part Number Configurator

PART NUMBER PLAN

SPEC Pak® Series (1 fixed character)	Shell Color (1 character)	Shell Style (1 character)	Dash	Shell Size (mm) (3 characters)	Insert Arrangement (3 characters)
S	K	2	-	053	B06
S = SPEC Pak® Series	K = Black	2 = Panel Mount Receptacle 6 = Straight Plug 8 = Right Angle Plug 9 = Cover		053 = 53 mm - 6 Pole Shell A53 = 53 mm - 6 Pole Right Angle Shell, PG 21 B53 = 53 mm - 6 Pole Right Angle Shell, PG 29	B06 = PP15/45 Housing (any type), 6 Pole

PLUG KIT

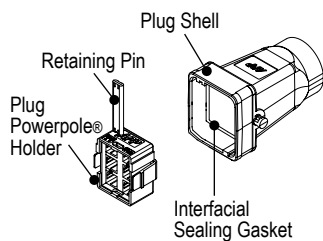

RIGHT ANGLE PLUG KIT

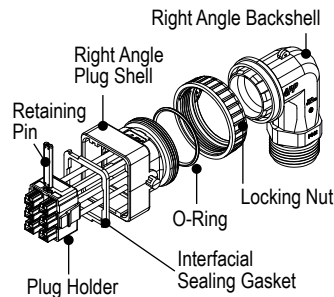

PANEL MOUNT RECEPTACLE KIT

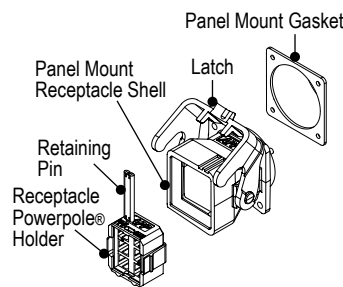

RECEPTACLE COVER KIT

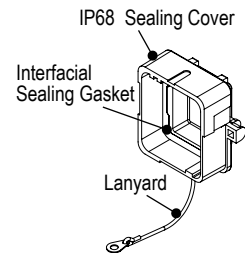

NOTE:

- Mounting hardware (4 each - M3.5 or #6 screws) not included
- Recommended torque for mounting hardware is 3½ to 5 in-lbf (0.4 to 0.56 Nm)

KIT ORDERING INFORMATION

SPEC Pak® Kits

Part Number	Description
SK6-053B06	Plug kit - Plug shell (includes interfacial sealing gasket) - Powerpole® holder for plug - Retaining pin
SK8-A53B06	Right angle plug kit for PG 21 - Right angle backshell for PG 21 - Locking nut - O-ring - Plug shell - Retaining pin - Powerpole® holder for plug
SK8-B53B06	Right angle plug kit for PG 29 - Right angle backshell for PG 29 - Locking nut - O-ring - Plug shell - Retaining pin - Powerpole® holder for plug

SPEC Pak® Kits

Part Number	Description
SK2-053B06	Receptacle kit - Panel mount gasket for receptacle - Receptacle shell with latch - Retention pin - Powerpole® holder for receptacle
SK9-053	Cover kit (receptacle only) - Protective sealing (IP68) cover for receptacle with lanyard

Component Replacement Parts

Part Number	Description
114765P1	Panel mount gasket for receptacle
2-8658P1	6 position latch
2-8654P1	Right angle locking nut
114915P2	Right angle O-ring

PART NUMBER PLAN

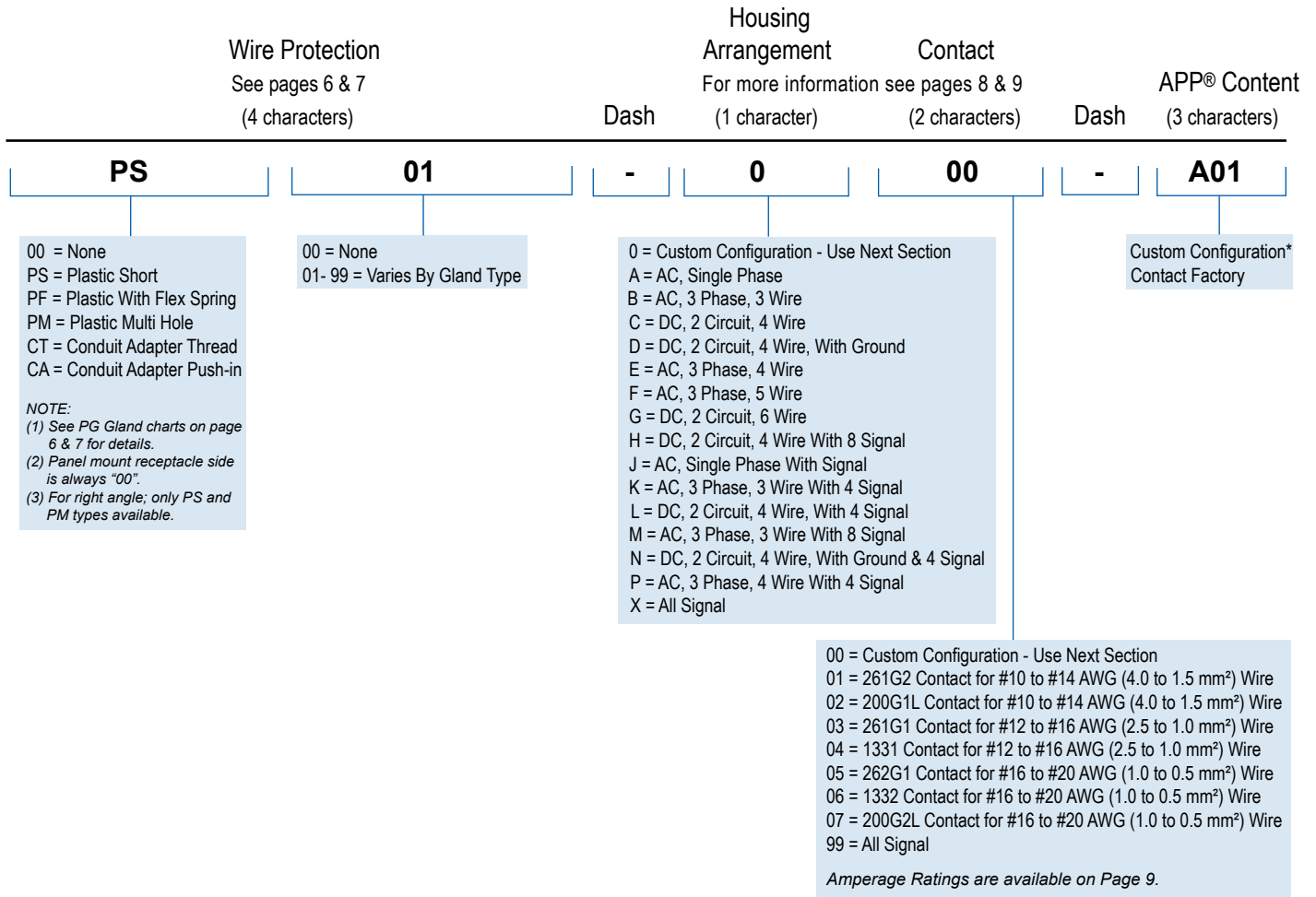

Part Numbering Notes:

- 1) To order SPEC Pak® "Shell Kits Only" (no internal Powerpole® housings or contacts), use part numbering on page 4 only. **Plug Shell Kit Example: SK6-053B06** Powerpole® housings, contacts and wire protection may be ordered separately, see pages 6, 7 and 10 for information.
- 2) To order complete standard configured SPEC Pak® connector kits (including internal Powerpole® housings and contacts) use Part Number Plan across the top of pages 4 and 5. **Standard SPEC Pak® Plug Connector Kit Configuration Example: SK6-053B06PS01-D02**
- 3) To order a custom configuration which is not listed on page 8 and 9, use APP® custom part number configurator on the APP® website, www.andersonpower.com, or contact factory.

* Custom configurations may not be UL Recognized.

Wire Protection - PG Gland

SPECIFICATIONS

Material (Push-in Conduit)

Shell	Nylon PA
Gasket	TPE
Color	Black

Mechanical

Operating Temp	-30°C to 100°C (-22°F to 212°F)
IP Rating	IP68
Thread Type	PG

Material (All Others)

Shell	Nylon PA 66 (UL94 V-2)*
Gasket	EPDM
Color	Black

Mechanical

Operating Temp	-40°C to 105°C (-40°F to 221°F)
IP Rating	IP68
UV Rating	Equivalent to UL746C F1
Thread Type	PG

Torque Requirements

Cable Gland Body to Plug Housing
- Hand tighten until snug, tighten additional 1/8 - 1/4 turn with wrench

Sealing Nut to Cable
- Hand tighten until snug, tighten additional 1/2 - 3/4 turn with wrench



* Contact factory for UL94 V-0 material

NOTE: Only UL listed cable glands are UL recognized components when used with SPEC Pak® connector(s).

STRAIGHT PLASTIC SHORT THREAD TYPE - STD PACK 50 / UL LISTED

Straight Gland Kit								Right Angle Gland Kit			
APP® P/N	APP® P/N	Wire Protection Designation (4 Characters)	PG Gland Size	Number of Holes	Cable Range Wire Outer Dia. mm (in)	Thread O. D. C1 mm (in)	Panel Mounting Hole mm (in)	Thread Length C2 mm (in)	Wrench Size Lock Nut (mm)	Wrench Size Sealing Nut (mm)	
Right Angle	Straight										
RPS1P21-16X	PS1P21-16X	PS01	21	1	16.2 - 10.5 (0.64 - 0.41)	28.3 (1.11)	28.3 - 28.7 (1.11 - 1.13)	12 (0.47)	36	33	
RPS1P21-18X	PS1P21-18X	PS02	21	1	18.5 - 13 (0.73 - 0.51)	28.3 (1.11)	28.3 - 28.7 (1.11 - 1.13)	12 (0.47)	36	33	
RPS1P29-22X	N/A	PS11	29	1	22 - 16 (0.86 - 0.63)	37 (1.46)	37 - 37.4 (1.46 - 1.47)	12 (0.47)	46	42	
RPS1P29-25X	N/A	PS12	29	1	25 - 18 (0.98 - 0.71)	37 (1.46)	37 - 37.4 (1.46 - 1.47)	12 (0.47)	46	42	

STRAIGHT PLASTIC WITH FLEX SPRING - STD PACK 50 / UL LISTED

APP® P/N	Wire Protection Designation (4 Characters)	Cable Range Wire Outer Dia. mm (in)	Thread O. D. C1 mm (in)	Panel Mounting Hole mm (in)	Thread Length C2 mm (in)	Wrench Size Lock Nut (mm)	Wrench Size Sealing Nut (mm)
Straight							
PF1P21-16X	PF01	15.8 - 10.5 (0.62 - 0.41)	28.3 (1.11)	28.3 - 28.7 (1.11 - 1.13)	12 (0.47)	36	33

LOCK NUT FOR PG 21 CABLE GLANDS

APP® P/N	Wrench Size Lock Nut (mm)	Std. Pkg. Size
124G30	36	50

STRAIGHT PLASTIC MULTI-HOLE TYPE - STD PACK 50 / NOT UL LISTED

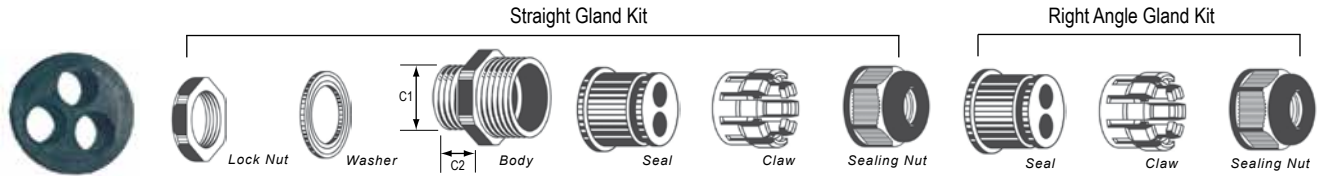

APP® P/N	APP® P/N	Wire Protection Designation (4 Characters)	PG Gland Size	Number of Holes	Cable Range Wire Outer Dia. mm(in)	Thread O.D. C1 mm (in)	Panel Mounting Hole mm (in)	Thread Length C2 mm (in)	Wrench Size Lock Nut (mm)	Wrench Size Sealing Nut (mm)
RPS2P21-5X	PS2P21-5X	PM21	21	2	5.2 - 3.6 (0.20 - 0.14)	28.3 (1.11)	28.3 - 28.7 (1.11 - 1.13)	12.5 (0.49)	36	33
RPS2P21-6X	PS2P21-6X	PM22	21	2	6.5 - 5.1 (0.26 - 0.20)	28.3 (1.11)	28.3 - 28.7 (1.11 - 1.13)	12.5 (0.49)	36	33
RPS2P21-8X	PS2P21-8X	PM23	21	2	8.7 - 6.4 (0.34 - 0.25)	28.3 (1.11)	28.3 - 28.7 (1.11 - 1.13)	12.5 (0.49)	36	33
RPS3P21-5X	PS3P21-5X	PM31	21	3	5.2 - 3.6 (0.20 - 0.14)	28.3 (1.11)	28.3 - 28.7 (1.11 - 1.13)	12.5 (0.49)	36	33
RPS3P21-6X	PS3P21-6X	PM32	21	3	6.2 - 4.8 (0.24 - 0.19)	28.3 (1.11)	28.3 - 28.7 (1.11 - 1.13)	12.5 (0.49)	36	33
RPS3P21-8X	PS3P21-8X	PM33	21	3	8.0 - 6.2 (0.31 - 0.24)	28.3 (1.11)	28.3 - 28.7 (1.11 - 1.13)	12.5 (0.49)	36	33
RPS4P21-3X	PS4P21-3X	PM41	21	4	3.1 - 2.0 (0.12 - 0.08)	28.3 (1.11)	28.3 - 28.7 (1.11 - 1.13)	12.5 (0.49)	36	33
RPS4P21-4X	PS4P21-4X	PM42	21	4	4.1 - 3.0 (0.16 - 0.12)	28.3 (1.11)	28.3 - 28.7 (1.11 - 1.13)	12.5 (0.49)	36	33
RPS4P21-5X	PS4P21-5X	PM43	21	4	5.2 - 3.8 (0.20 - 0.15)	28.3 (1.11)	28.3 - 28.7 (1.11 - 1.13)	12.5 (0.49)	36	33
RPS4P21-7X	PS4P21-7X	PM44	21	4	7.3 - 5.6 (0.29 - 0.22)	28.3 (1.11)	28.3 - 28.7 (1.11 - 1.13)	12.5 (0.49)	36	33
RPS5P21-3X	PS5P21-3X	PM51	21	5	3.6 - 2.6 (0.14 - 0.10)	28.3 (1.11)	28.3 - 28.7 (1.11 - 1.13)	12.5 (0.49)	36	33
RPS5P21-4X	PS5P21-4X	PM52	21	5	4.6 - 3.6 (0.18 - 0.14)	28.3 (1.11)	28.3 - 28.7 (1.11 - 1.13)	12.5 (0.49)	36	33
RPS5P21-6X	PS5P21-6X	PM53	21	5	6.0 - 4.6 (0.24 - 0.18)	28.3 (1.11)	28.3 - 28.7 (1.11 - 1.13)	12.5 (0.49)	36	33
RPS6P21-3X	PS6P21-3X	PM61	21	6	3.6 - 2.6 (0.14 - 0.10)	28.3 (1.11)	28.3 - 28.7 (1.11 - 1.13)	12.5 (0.49)	36	33
RPS6P21-5X	PS6P21-5X	PM62	21	6	5.2 - 3.6 (0.20 - 0.14)	28.3 (1.11)	28.3 - 28.7 (1.11 - 1.13)	12.5 (0.49)	36	33

STRAIGHT CONDUIT ADAPTER THREAD TYPE - STD PACK 50 / NOT UL LISTED

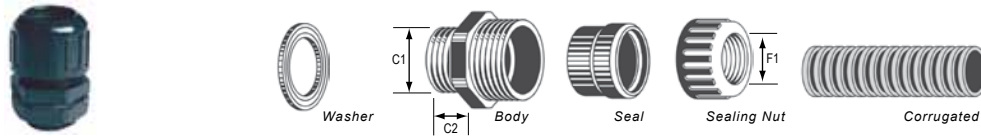

APP® P/N	Wire Protection Designation (4 Characters)	Max. Joint F1 mm (in)	Thread O.D. C1 mm (in)	Panel Mounting Hole mm (in)	Thread Length C2 mm (in)	Wrench Size Lock Nut (mm)	APP® Conduit P/N	Conduit O. D.
CT1P21-21X	CT02	22.0 (0.87)	28.3 (1.11)	28.3 - 28.7 (1.11 - 1.13)	12 (0.47)	36	NGN - 17B	21.2 (0.83)
CT1P21-26X	CT03	26.5 (1.04)	28.3 (1.11)	28.3 - 28.7 (1.11 - 1.13)	12 (0.47)	36	NGN - 22B	26.2 (1.03)
CT1P21-28X	CT04	28.5 (1.12)	28.3 (1.11)	28.3 - 28.7 (1.11 - 1.13)	12 (0.47)	36	NGN - 23B	28.5 (1.12)

STRAIGHT CONDUIT PUSH-IN TYPE - STD PACK 50 / NOT UL LISTED

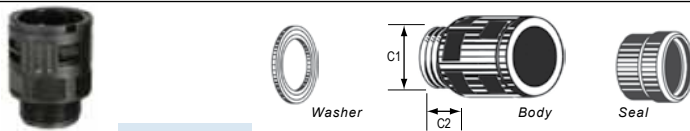

APP® P/N	Wire Protection Designation (4 Characters)	Thread O.D. C1 mm (in)	Panel Mounting Hole mm (in)	Thread Length C2 mm (in)	Wrench Size Lock Nut (mm)	APP® Conduit P/N	Conduit O. D.
CAP21-28X	CA04	28.3 (1.11)	28.3 - 28.7 (1.11 - 1.13)	12 (0.5)	36	NGN - 23B	28.5 (1.12)

CORRUGATED NYLON PLASTIC TUBING

APP® P/N	Conduit I. D. mm (in)	Conduit O. D. mm (in)	Conduit Size	Trade Size (mm)	Std. Pkg. Meters (Feet)
NGN - 17B	16.7 (0.66)	21.2 (0.83)	1/2"	OD21.2	50 (164)
NGN - 22B	21.2 (0.83)	26.2 (1.03)	-	-	50 (164)
NGN - 23B	21.7 (0.85)	28.5 (1.12)	3/4"	OD28.5	50 (164)

TUBING CUTTER



APP® P/N	Description	Range (mm)
TM0002	Corrugated Plastic Tubing Cutter	Up to OD 34.5

Standard Housing Arrangements & Contacts

HOUSING ARRANGEMENTS FOR POWER, SIGNAL & GROUND CONNECTORS

ARRANGEMENTS REPRESENT FRONT VIEW OF RECEPTACLE

Custom configurations may be created using APP's part number configurator at www.andersonpower.com

E = Empty 1327 Series = Power 1827 Series = Ground 4800 Series = Signal

0 Custom Configuration

AC Single Phase

A	1327G6FP	E
	E	1827G1
	1327G7FP	E

AC 3 Phase, 3 Wire

B	1327G6FP	E
	1327G7FP	1827G1
	1327FP	E

DC 2 Circuit, 4 Wire

C	1327G6FP	1327G6FP
	E	E
	1327FP	1327FP

DC 2 Circuit, 4 Wire With Ground

D	1327G6FP	1327G6FP
	E	1827G1
	1327FP	1327FP

AC 3 Phase, 4 Wire

E	1327G6FP	1327G8FP
	1327G7FP	1827G1
	1327FP	E

AC 3 Phase, 5 Wire

F	1327G6FP	1327G8FP
	1327G7FP	1827G1
	1327FP	1327G16FP

DC 2 Circuit, 6 Wire

G	1327FP	1327G6FP
	1327FP	1327G6FP
	1327FP	1327G6FP

DC 2 Circuit, 4 Wire With 8 Signal

H	1327G6FP	1327G6FP
	4827G6	4827G6
	1327FP	1327FP

AC Single Phase With 4 Signal

J	1327G6FP	E
	E	1827G1
	1327G7FP	4827G6

AC 3 Phase, 3 Wire With 4 Signal

K	1327G6FP	E
	1327G7FP	1827G1
	1327FP	4827G6

DC 2 Circuit, 4 Wire With 4 Signal

L	1327G6FP	1327G6FP
	E	4827G6
	1327FP	1327FP

AC 3 Phase, 3 Wire With 8 Signal

M	1327FP	1327G7FP
	4827G6	4827G6
	1327G6FP	1827G1

DC 2 Circuit, 4 Wire With Ground & 4 Signal

N	1327G6FP	1327G6FP
	4827G6	1827G1
	1327FP	1327FP

AC 3 Phase, 4 Wire With 4 Signal

P	1327G6FP	1327G8FP
	1327G7FP	1827G1
	1327FP	4827G6

All Signal

X	4827G6	4827G6
	4827G6	4827G6
	4827G6	4827G6

CONTINUOUS CURRENT RATINGS - POWER CONTACT CODE SELECTION

Contact Code	Power Contacts	Housing Configuration	Wire Size / Current Rating					
			#10	#12	#14	#16	#18	#20
00	Contacts Purchased Separately							
01	261G2	A - C	29/40	20/33	15/23	—	—	—
		D - G	24/36	20/25	15/21	—	—	—
		H - P	29/40	20/33	15/22	—	—	—
02	200G1L	A - C	27/37	20/32	15/22	—	—	—
		D - G	22/33	18/25	15/20	—	—	—
		H - P	27/37	20/32	15/22	—	—	—
03	261G1	A - C	—	20/33	15/23	12/18	—	—
		D - G	—	20/25	15/21	12/18	—	—
		H - P	—	20/33	15/22	12/18	—	—
04	1331	A - C	—	17/25	15/25	13/20	—	—
		D - G	—	15/25	15/22	13/18	—	—
		H - P	—	17/25	15/20	13/20	—	—
05	262G1	A - C	—	—	—	12/18	10/15	7/10
		D - G	—	—	—	12/18	8/13	6/9
		H - P	—	—	—	12/18	10/15	7/10
06	1332	A - C	—	—	—	13/20	9/14	6/9
		D - G	—	—	—	13/18	7/12	5/8
		H - P	—	—	—	13/20	9/14	6/9

NOTES:

- Current ratings:
 - First number represents current rating per pole for 30°C temperature rise (29 / 40)
 - Second number is the maximum recommended current per pole based on a 25°C ambient (29 / 40)
- Configuration H - P based on signal contacts crimped to #20 AWG wire and carrying 1 amp
- ☐ Denotes wire size not appropriate for power contact
- Shaded boxes ☐ are c  File No. E26226 pending.
- 1827G1 housing with 1830G1 or 1830G2 ground contact depending on primary contacts (see chart above). All signal housing kits (4850G6) come with two 4802G3 and two 4802G3 contacts.

HOLDER LOCATIONS (VIEWS)

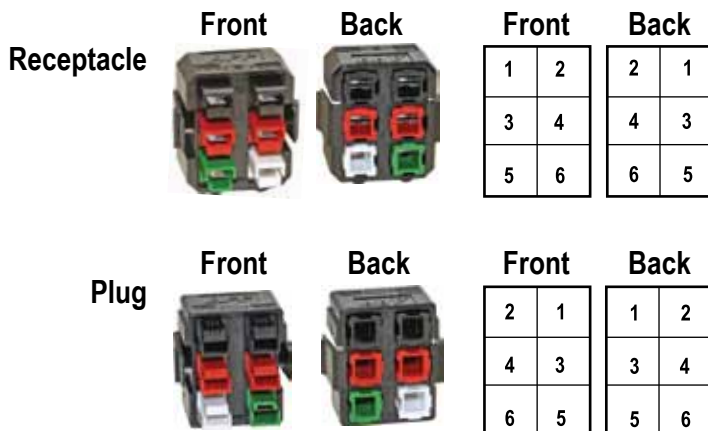

TEMPERATURE CHART

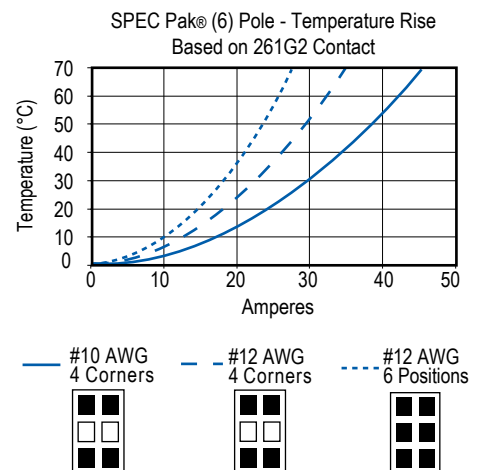

Individual Components

POWERPOLE® HOUSINGS & CONTACTS

Fingerproof PP15/45 Housing Only

Package Quantity:

Standard, 100 pieces - Bulk, 1,000 pieces

Standard Part Number	Bulk Part Number	Description
1327FP	1327FP-BK	Red Housing
1327G5FP	1327G5FP-BK	Green Housing
1327G6FP	1327G6FP-BK	Black Housing
1327G7FP	1327G7FP-BK	White Housing
1327G8FP	1327G8FP-BK	Blue Housing
1327G16FP	1327G16FP-BK	Yellow Housing

Standard PP 15/45 Housing Only

Package Quantity:

Standard, 100 pieces - Bulk, 1,000 pieces

Standard Part Number	Bulk Part Number	Description
1327	1327-BK	Red Housing
1327G5	1327G5-BK	Green Housing
1327G6	1327G6-BK	Black Housing
1327G7	1327G7-BK	White Housing
1327G8	1327G8-BK	Blue Housing
1327G16	1327G16-BK	Yellow Housing
1327G17	1327G17-BK	Orange Housing
1327G18	1327G18-BK	Gray Housing
1327G21	1327G21-BK	Brown Housing
1327G22	1327G22-BK	Pink Housing
1327G23	1327G23-BK	Purple Housing

Premate Ground PP15/45 Housing Only

Package Quantity:

Standard, 100 pieces - Bulk, 1,000 pieces

Standard Part Number	Bulk Part Number	Description
1827G1	1827G1-BK	Green Housing

Premate Ground Contacts

Loose Piece

Package Quantity 100

Part Number	Description
#10 to #14 AWG (4 to 1.5 mm ²)	
1830G1-LPBK	Singulated-LD-Tin Plate
1830G2-LPBK	Singulated-LD-Silver Plate

Reel

Package Quantity 5,000

Part Number	Description
#10 to #14 AWG (4 to 1.5 mm ²)	
1830G1	Reel-LD-Tin Plate
1830G2	Reel-LD-Silver Plate

15/45 Powerpole® Contacts

Loose Piece

Package Quantity:

Standard, 100 pieces - Bulk, 1,000 pieces

Standard Part Number	Bulk Part Number	Description
#16 to #20 AWG (1.0 to 0.5 mm ²)		
1332	1332-BK	Individual-LD-Silver Plate
262G1-LPBK	-	Singulated Reel-LD-Tin Plate
262G2-LPBK	-	Singulated Reel-LD-Silver Plate
#12 to #16 AWG (2.5 to 1.0 mm ²)		
1331	1331-BK	Individual-LD-Silver Plate
261G1-LPBK	-	Singulated Reel-LD-Tin Plate
#10 to #14 AWG (4 to 1.5 mm ²)		
261G2-LPBK	-	Singulated Reel-LD-Tin Plate
261G3-LPBK	-	Singulated Reel-LD-Silver Plate
200G1L-LPBK	-	Superflex, Sing. Reel-LD-Tin Plate

Reel - 15/45 Powerpole® Contacts

Package Quantity 5,000

Part Number	Description
#16 to #20 AWG (1.0 to 0.5 mm ²)	
262G1	Reel-LD-Tin Plate
262G2	Reel-LD-Silver Plate
#12 to #16 AWG (2.5 to 1.0 mm ²)	
261G1	Reel-LD-Tin Plate
#10 to #14 AWG (4 to 1.5 mm ²)	
261G2	Reel-LD-Tin Plate
261G3	Reel-LD-Silver Plate
#10 to #14 AWG (6 to 1.5mm ²)	
200G1L	SuperFlex, Reel-LD-Tin Plate

NOTE:

LD - Low Detent

For additional housing colors please contact customer service.

CONTACT STYLES

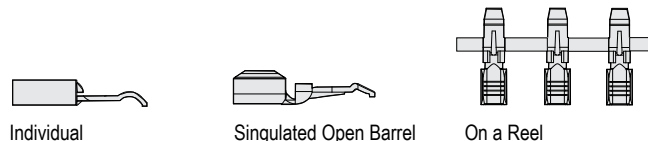

PPMX (4800 SERIES) HOUSING & CONTACTS

PPMX Housing

Package Quantity
Standard, 25 pieces - Bulk, 1,000 pieces

Standard	Bulk	
Part Number	Part Number	Description
4827G6	4827G6-BK	Black two piece housing

PPMX Contacts

Package Quantity
Standard, 50 pieces - Bulk, 2,000 pieces

Loose Piece

#20 to #24 AWG (0.50 to 0.25 mm²)

Standard	Bulk	
Part Number	Part Number	Description
4802G3	4802G3-BK	Socket, Gold, 50 Micro-inches
4803G3	4803G3-BK	Pin, Gold, 50 Micro-inches

PPMX Housing & Contact Kits

Package Quantity
Standard, 100 pieces

**1 Black two piece housing, 2 Male Contacts,
2 Female Contacts**

Standard	Bulk	
Part Number	Part Number	Description
4850G6	-	50 Micro-inches Gold Plated Contacts - Pin & Socket

PP15/45 POWERPOLE® HOUSING STYLES

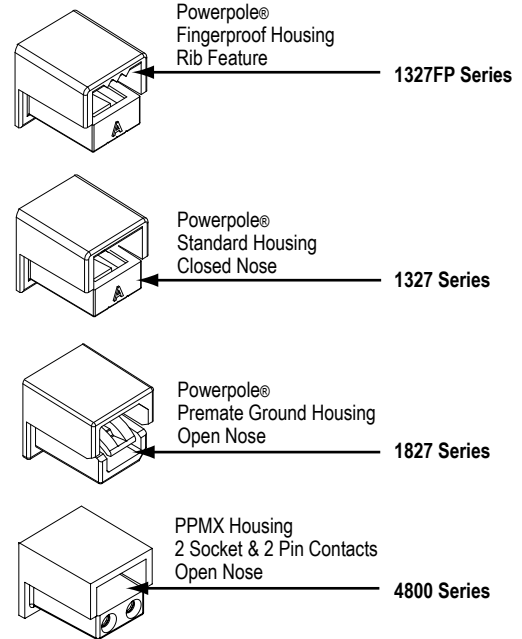

APPLICATION TOOLING - POWERPOLE® 15 / 45 CONTACTS

Loose Piece Tin Part Number	Loose Piece Silver Part Number	Hand Tool or Pneumatic Tool		Reeled Tin Part Number	Reeled Silver Part Number	ATS Applicator	
N/A	1332	1309G2 or 1309G8		N/A	N/A	N/A	
N/A	1331			1367G1	N/A	N/A	N/A
262G1-LPBK	262G2-LPBK			N/A		261G1	262G2
200G2L-LPBK	200G4L-LPBK	TBD					
261G1-LPBK	261G4-LPBK	1385520					
261G2-LPBK	261G3-LPBK	1385458					
200G1L-LPBK	200G3L-LPBK	1385460					
1830G1-LPBK	1830G2-LPBK	1385460					

* All Hand and Pneumatic Tools for use with Loose Piece contacts only. All reeled contacts can be ordered singulated, (Loose Piece) with the suffix "- LPBK"

** 1309G8 is a hand tool kit- includes dies and locators to make up 1309G2, 1309G3, & 1309G6

APPLICATION TOOLING - PPMX CONTACTS

Contact Part Number	Mil Std. Hand Tool			Pneumatic Tool for Locator / Turret
	APP® Hand Tool or	Tool (APP Part #)	Positioner	
4802G3	PM1000G1	M22520/1-01 (TM0001)	No Mil Std. (TL0005)	TP0001
4803G3				

Dimensions

PLUG 6 POSITION FOR PP15/45 HOUSINGS

Top View

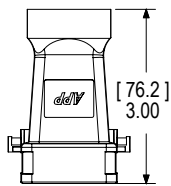

Front View

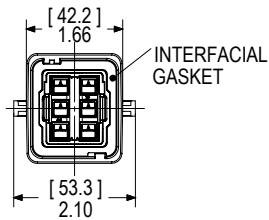

Side View

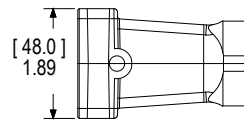

Mated Side View

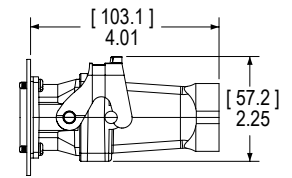

RIGHT ANGLE PLUG 6 POSITION FOR PP15/45 - GLAND SIZE PG 21

Top View

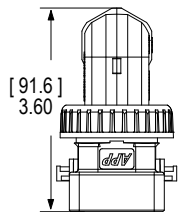

Front View

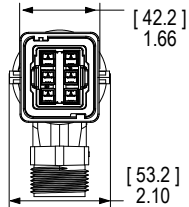

Side View

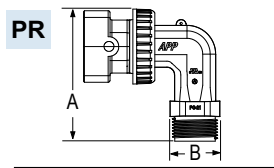

PG Gland	- A - mm	in.	- B - mm	in.
PG 21	104.7	4.12	36.4	1.43
PG 29	105.5	4.15	47.4	1.86

Mated Side View

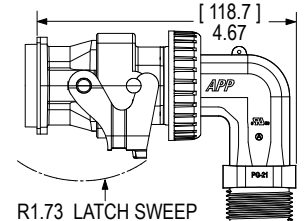

For PG 29 dimensions, please see APP website

RECEPTACLE 6 POSITION FOR PP15/45 HOUSINGS

Panel Cut Out

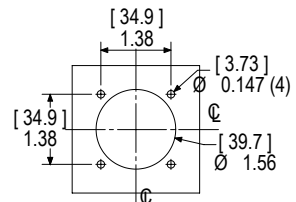

PANEL CUT OUT \varnothing

(SAME AS 26482 & 5015 SHELL SIZE 24)

Front View

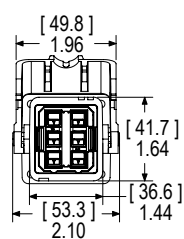

Side View

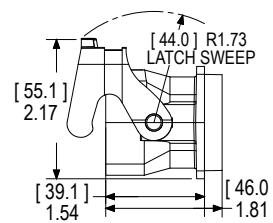

Back View

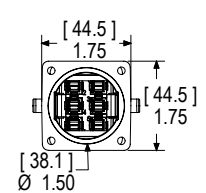

NOTE: Mounting hardware #6 screw / torque receptacle to panel 3/2 to 5 in-lbf (0.4 to 0.56 Nm)

PG GLANDS

PS

Plastic Short

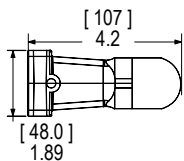

CT

Thread Conduit Adapter

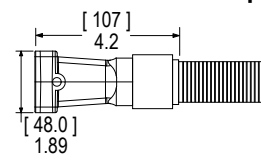

PF

Plastic Flex PG

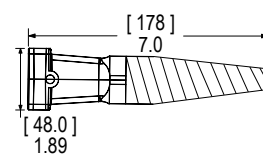

CA

Push-in Conduit Adapter

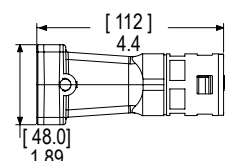

RECEPTACLE COVER KIT

Front View

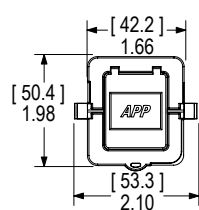

Side View

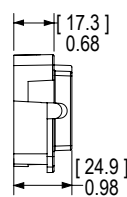

Mated Side View

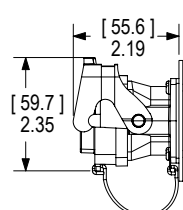

All Data Subject To Change Without Notice Patents

15052 DS-SPAK REV06

HEADQUARTERS: Anderson Power Products®, 13 Pratts Junction Road, Sterling, MA 01564-2305 USA T:978-422-3600 F:978-422-0128

EUROPE: Anderson Power Products® Ltd., Unit 3, Europa Court, Europa Boulevard, Westbrook, Warrington, Cheshire, WA5 7TN United Kingdom T: +44 (0) 1925 428390 F: +44 (0) 1925 520203

ASIA / PACIFIC: IDEAL Anderson Asia Pacific Ltd., Unit 922-928 Topsail Plaza, 11 On Sum Street, Shatin N.T., Hong Kong T: +(852) 2636 0836 F: +(852) 2635 9036

CHINA: IDEAL Anderson Technologies (Shenzhen) Ltd., Block A8 Tantou Western Industrial Park, Songgang Baoan District, Shenzhen, P.R. China 518105 T: +(86) 755 2768 2118 F: +(86) 755 2768 2218

TAIWAN: IDEAL Anderson Asia Pacific Ltd., Taiwan Branch, 4F-2, No.116, Dadun 20th St., Situn District, Taichung City 407, Taiwan (R.O.C.) T: +(886) 4 2310 6451 F: +(886) 4 2310 6460

www.andersonpower.com

Mouser Electronics

Authorized Distributor

Click to View Pricing, Inventory, Delivery & Lifecycle Information:

Anderson Power Products:

[114765P1](#) [B02047P1](#) [SK6-053B06PS02-B03](#) [SK6-053B06PS02-B04](#) [SK6-053B06PS02-C02](#) [SK6-053B06PS02-C03](#) [SK6-053B06PS02-D02](#) [SK6-053B06PS02-D04](#) [SK6-053B06PS02-D06](#) [SK6-053B06PS02-E01](#) [SK6-053B06PS02-E04](#) [SK6-053B06PS02-F06](#) [SK6-053B06PS02-G01](#) [SK6-053B06PS02-G03](#) [SK6-053B06PS02-G04](#) [SK2-053B060000-G06](#) [SK2-053B060000-G01](#) [SK2-053B060000-G04](#) [SK2-053B060000-H01](#) [SK6-053B060000-A03](#) [SK6-053B060000-A04](#) [SK6-053B060000-A06](#) [SK6-053B060000-B02](#) [SK6-053B060000-C01](#) [SK6-053B06CT04-A03](#) [SK6-053B06CT04-B01](#) [SK6-053B06CT04-B03](#) [SK6-053B06CT04-C01](#) [SK6-053B06CT04-C02](#) [SK6-053B06CT04-D01](#) [SK6-053B06CT04-D04](#) [SK6-053B06CT04-D02](#) [SK6-053B06CT04-E03](#) [SK6-053B06CT04-E04](#) [SK6-053B06CT04-G03](#) [SK6-053B06CT04-G04](#) [SK6-053B06PF01-A04](#) [SK6-053B06PF01-B01](#) [SK6-053B06PF01-C01](#) [SK6-053B06PF01-D01](#) [SK6-053B06PF01-D02](#) [SK6-053B06PF01-E04](#) [SK6-053B06PF01-E06](#) [SK6-053B06PF01-F01](#) [SK6-053B06PF01-F02](#) [SK6-053B06PF01-F03](#) [SK6-053B06PF01-F04](#) [SK6-053B06PF01-G02](#) [SK6-053B06PF01-G03](#) [SK6-053B06PF01-G04](#) [SK6-053B06PF01-G06](#) [SK6-053B06PS02-A01](#) [SK6-053B06PS02-A03](#) [SK6-053B06PS02-A06](#) [SK6-053B06PS02-B02](#) [SK6-053B060000-B03](#) [SK6-053B060000-B04](#) [SK6-053B060000-B06](#) [SK6-053B060000-C02](#) [SK2-053B060000-N02](#) [SK2-053B060000-A02](#) [SK2-053B060000-A03](#) [SK2-053B060000-A06](#) [SK2-053B060000-B01](#) [SK2-053B060000-B04](#) [SK2-053B060000-C02](#) [SK2-053B060000-C03](#) [SK2-053B060000-C04](#) [SK2-053B060000-D01](#) [SK2-053B060000-E03](#) [SK2-053B060000-E04](#) [SK2-053B060000-F01](#) [SK6-053B060000-C04](#) [SK6-053B060000-C06](#) [SK6-053B060000-D01](#) [SK6-053B060000-D02](#) [SK6-053B060000-D04](#) [SK6-053B060000-E01](#) [SK6-053B060000-E02](#) [SK6-053B060000-E03](#) [SK6-053B060000-E06](#) [SK6-053B060000-F02](#) [SK6-053B060000-F03](#) [SK6-053B060000-F04](#) [SK6-053B060000-F06](#) [SK6-053B060000-G02](#) [SK6-053B060000-G03](#) [SK2-053B060000-F06](#) [SK2-053B060000-G02](#) [SK2-053B060000-G03](#) [SK6-053B060000-A01](#) [SK6-053B060000-A02](#) [SK6-053B060000-B01](#) [SK6-053B06PF01-E02](#) [SK6-053B06PF01-E03](#) [SK6-053B06PF01-F06](#) [SK6-053B06PF01-G01](#) [SK6-053B06PF01-H01](#) [SK6-053B06PS02-A02](#) [SK6-053B06PS02-A04](#)



Компания «ЭлектроПласт» предлагает заключение долгосрочных отношений при поставках импортных электронных компонентов на взаимовыгодных условиях!

Наши преимущества:

- Оперативные поставки широкого спектра электронных компонентов отечественного и импортного производства напрямую от производителей и с крупнейших мировых складов;
- Поставка более 17-ти миллионов наименований электронных компонентов;
- Поставка сложных, дефицитных, либо снятых с производства позиций;
- Оперативные сроки поставки под заказ (от 5 рабочих дней);
- Экспресс доставка в любую точку России;
- Техническая поддержка проекта, помощь в подборе аналогов, поставка прототипов;
- Система менеджмента качества сертифицирована по Международному стандарту ISO 9001;
- Лицензия ФСБ на осуществление работ с использованием сведений, составляющих государственную тайну;
- Поставка специализированных компонентов (Xilinx, Altera, Analog Devices, Intersil, Interpoint, Microsemi, Aeroflex, Peregrine, Syfer, Eurofarad, Texas Instrument, Miteq, Cobham, E2V, MA-COM, Hittite, Mini-Circuits, General Dynamics и др.);

Помимо этого, одним из направлений компании «ЭлектроПласт» является направление «Источники питания». Мы предлагаем Вам помощь Конструкторского отдела:

- Подбор оптимального решения, техническое обоснование при выборе компонента;
- Подбор аналогов;
- Консультации по применению компонента;
- Поставка образцов и прототипов;
- Техническая поддержка проекта;
- Защита от снятия компонента с производства.



Как с нами связаться

Телефон: 8 (812) 309 58 32 (многоканальный)

Факс: 8 (812) 320-02-42

Электронная почта: org@eplast1.ru

Адрес: 198099, г. Санкт-Петербург, ул. Калинина, дом 2, корпус 4, литера А.