

6 POSITION SPEC Pak[®]

Sealed Power For Environmental Connections



Marine | Wind Power | Lighting | Transportation | Pumps | Ground Support
Machine Tool | Industrial Automation | Motor | Solar Power | Harsh Environments



APP
Anderson Power Products

Rugged and Sealed (IP68) Plugs and Receptacles

For Use with APP® Powerpole® Signal, Power & Ground Contacts & Housings

APP's SPEC Pak® Connector Series uses rugged and environmentally sealed (IP68) shells to protect existing APP® Powerpole® contacts and housings. Customer configured SPEC Pak® Connectors may be used anywhere a rugged and waterproof high-power interconnect with signal and ground capabilities is required such as in; mass transportation, off-road vehicles, factory automation, oil and petrochemical exploration, agricultural equipment, and many more.

The core APP® Powerpole® technology within the SPEC Pak® is proven reliable and cost effective. The broad selection of touch safe, color-coded Powerpole® housings with power, signal and ground contacts accept a broad range of wire gauges, #24 to #10 AWG (0.25 to 4.0 mm²), giving users thousands of flexible design solutions in a single interconnect.

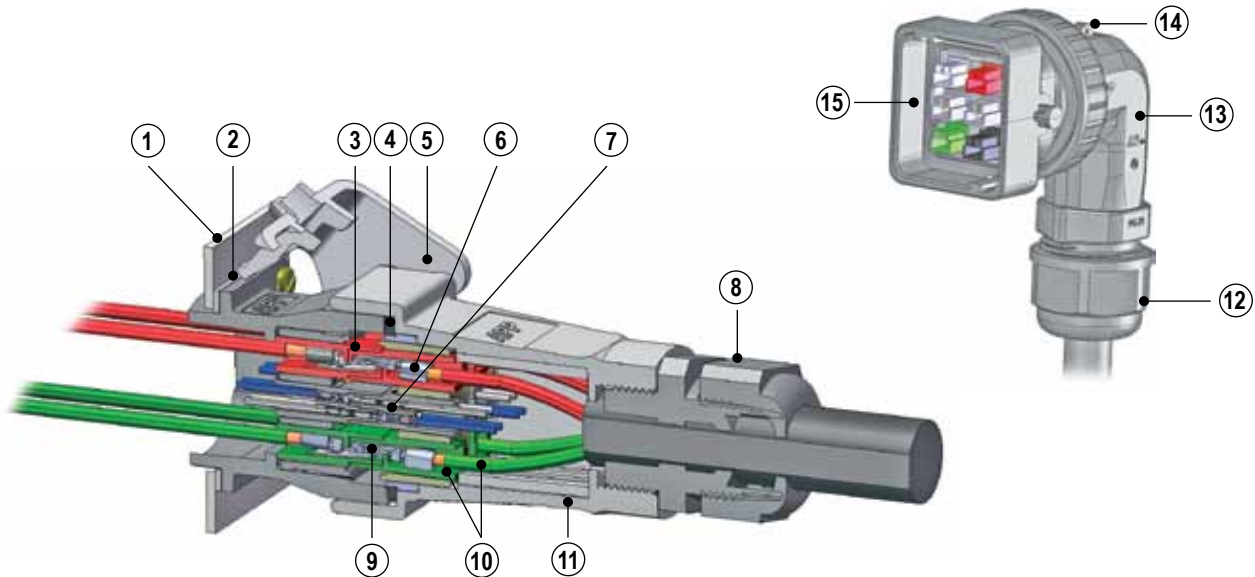

1 - Industry Standard Panel Cut Out

(Same as 26482 & 5015 shell size 24)

2 - IP68 Panel Mount Sealing Gasket

3 - Touch Safe Housings (UL1977, Section 10.2)

4 - IP68 Interfacial Sealing Gasket

5 - Latch (top or bottom of plug or receptacle)

6 - Power Contacts (up to 45 amps)

7 - Signal Contacts (4 contacts per PPMX housing)

8 - Uses Industry Standard Sealing Components

(PG gland compatible - size 21)

9 - First Mate / Last Break Ground Contacts

10 - Color Coded Housings to Match Wire Color

11 - UV & Chemical Resistant Ruggedized Shells

Additional Features Available on the Right Angle Include:

12 - Uses Industry Standard PG Gland

(PG gland compatible - size 21 or 29)

13 - Right Angle Backshell Lockable in 8 Directions for Cable Routing

14 - Integrated Strain Relief

15 - Ruggedized Right Angle Plug Shell

Specifications

SPEC Pak® Shell / Components

Electrical

| | |
|--------------------------------------|--------------|
| UL Voltage Rating (AC/DC) | 600 |
| Dielectric Withstanding Voltage (AC) | 3000 |
| Operating Temperature (°C) | -40° to 105° |
| (°F) | -40° to 221° |
| Flammability Rating of SPEC Shells | UL 94V-0 |

Mechanical

| | |
|---------------------------------|----------|
| Shells / Latch Mating Cycles | 1500 Min |
| Connect / Disconnect (lbf) | 18 Max |
| (N) | 80 Max |
| IP Rating | IP68 |
| UL50 Sec 30 Sealing Requirement | Pass |

Material

| | |
|----------------------------|---------------|
| Shells (Plug / Receptacle) | PBT |
| Latch | Nylon |
| Holder | Polycarbonate |

PPMX (4800 Series) Powerpole® Signal Contact

Ratings for SPEC Pak® Use

Electrical

| | |
|--------------------------------|--------------|
| UL Current Rating (Amperes) | 7 |
| Voltage Rating (AC/DC) | 300 |
| Contact Barrel Wire Size (AWG) | #20 to #24 |
| (mm ²) | 0.5 to 0.25 |
| Contact Retention Force (lbf) | 12.0 |
| (N) | 53.0 |
| Insertion Force (lbf) | 4.5 Max |
| (N) | 20.0 Max |
| Operating Temperature (°C) | -20° to 105° |
| (°F) | -4° to 221° |

Mechanical

| | |
|-------------------------|------|
| Mating Cycles (No load) | 1500 |
|-------------------------|------|

Material

| | |
|------------------|-----------------------|
| Housing Material | PBT |
| Contact Material | Copper Alloy |
| Contact Plating | Gold, 50 Micro-inches |

NOTE: PPMX Contacts, up to 4 per housing

Powerpole® Power (1327FP Series) & Ground (1827 Series) Contacts

Ratings for SPEC Pak® Use

Electrical

| | |
|---|--------------|
| UL Current Rating (Amperes) | 15 to 45 |
| CSA (30°C Rise) (Amperes) | 10 to 29 |
| Voltage Rating (AC/DC) | 600 |
| Contact Barrel Wire Size (AWG) - Power | 20 to 10 |
| - Ground | 14 to 10 |
| (mm ²) - Power | 0.5 to 4.0 |
| - Ground | 1.5 to 4.0 |
| Average Contact Resistance (micro-ohms) | 600 |
| Contact Retention Force (lbf) | 25 |
| (N) | 111 |
| Operating Temperature (°C) | -20° to 105° |
| (°F) | -4° to 221° |
| Flammability Rating | UL94 V-0 |

Mechanical

| | |
|--|---------------------------------|
| Mating Cycles | |
| No Load | |
| - Tin | 1,500 |
| - Silver | 10,000 |
| Under Load (Hot Plug 250 mating cycles @ 120V) * | 30A |
| (Hot Plug 250 mating cycles @ 72V) * | 45A |
| Mechanical Shock (50 g) | Mil Standard 202 213 Cond. A |
| Vibration (10 g) | Mil Standard 202 204 Cond. A |

Material

| | |
|-------------------------------------|------------------|
| Housing Material | Polycarbonate |
| Touch Safe (Power / Signal Housing) | UL1977 Sec. 10.2 |
| Contact Material | Copper |
| Contact Plating | Tin or Silver |

* Hot Plug testing completed with individual Powerpole® housings

NOTE: Agency approvals - TUV (contact customer service) / Patents

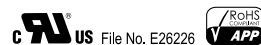

Part Number Configurator

PART NUMBER PLAN

| SPEC Pak® Series (1 fixed character) | Shell Color (1 character) | Shell Style (1 character) | Dash | Shell Size (mm) (3 characters) | Insert Arrangement (3 characters) |
|---|------------------------------|--|----------|--|--|
| S | K | 2 | - | 053 | B06 |
| S = SPEC Pak® Series | K = Black | 2 = Panel Mount Receptacle 6 = Straight Plug 8 = Right Angle Plug 9 = Cover | | 053 = 53 mm - 6 Pole Shell A53 = 53 mm - 6 Pole Right Angle Shell, PG 21 B53 = 53 mm - 6 Pole Right Angle Shell, PG 29 | B06 = PP15/45 Housing (any type), 6 Pole |

PLUG KIT

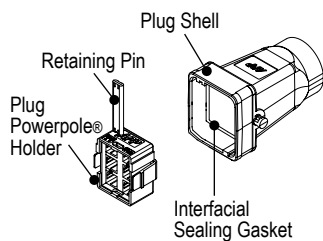

RIGHT ANGLE PLUG KIT

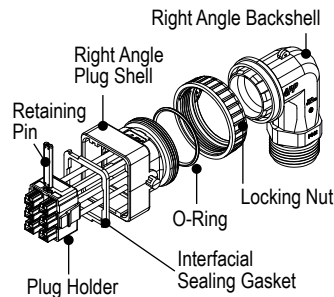

PANEL MOUNT RECEPTACLE KIT

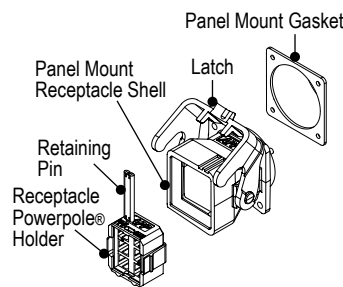

RECEPTACLE COVER KIT

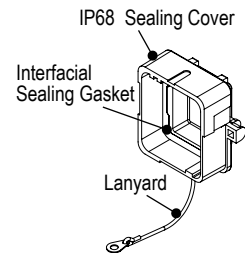

NOTE:

- Mounting hardware (4 each - M3.5 or #6 screws) not included
- Recommended torque for mounting hardware is 3½ to 5 in-lbf (0.4 to 0.56 Nm)

KIT ORDERING INFORMATION

SPEC Pak® Kits

| Part Number | Description |
|-------------|---|
| SK6-053B06 | Plug kit - Plug shell (includes interfacial sealing gasket) - Powerpole® holder for plug - Retaining pin |
| SK8-A53B06 | Right angle plug kit for PG 21 - Right angle backshell for PG 21 - Locking nut - O-ring - Plug shell - Retaining pin - Powerpole® holder for plug |
| SK8-B53B06 | Right angle plug kit for PG 29 - Right angle backshell for PG 29 - Locking nut - O-ring - Plug shell - Retaining pin - Powerpole® holder for plug |

SPEC Pak® Kits

| Part Number | Description |
|-------------|---|
| SK2-053B06 | Receptacle kit - Panel mount gasket for receptacle - Receptacle shell with latch - Retention pin - Powerpole® holder for receptacle |
| SK9-053 | Cover kit (receptacle only) - Protective sealing (IP68) cover for receptacle with lanyard |

Component Replacement Parts

| Part Number | Description |
|-------------|-----------------------------------|
| 114765P1 | Panel mount gasket for receptacle |
| 2-8658P1 | 6 position latch |
| 2-8654P1 | Right angle locking nut |
| 114915P2 | Right angle O-ring |

PART NUMBER PLAN

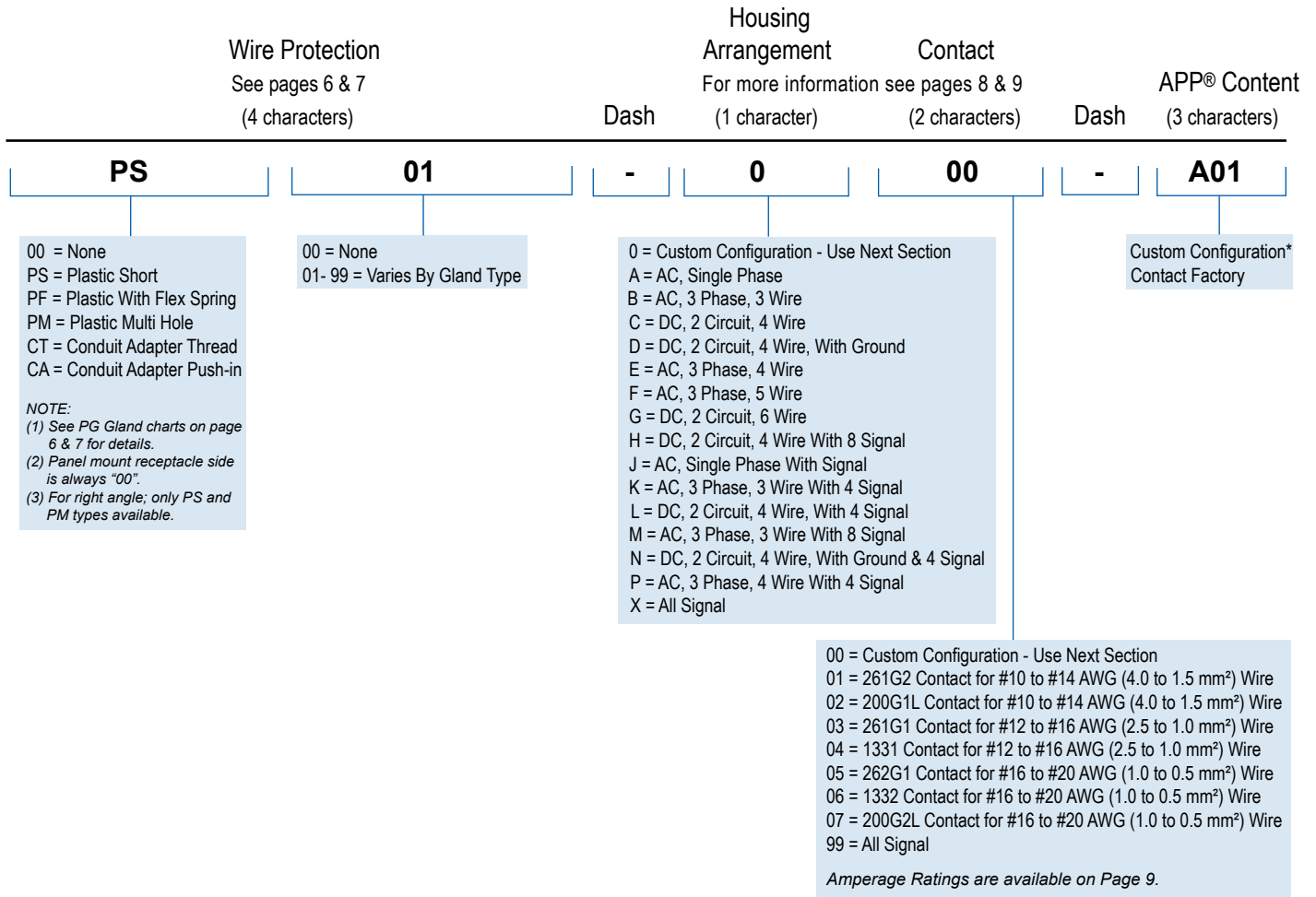

Part Numbering Notes:

- 1) To order SPEC Pak® "Shell Kits Only" (no internal Powerpole® housings or contacts), use part numbering on page 4 only. **Plug Shell Kit Example: SK6-053B06** Powerpole® housings, contacts and wire protection may be ordered separately, see pages 6, 7 and 10 for information.
- 2) To order complete standard configured SPEC Pak® connector kits (including internal Powerpole® housings and contacts) use Part Number Plan across the top of pages 4 and 5. **Standard SPEC Pak® Plug Connector Kit Configuration Example: SK6-053B06PS01-D02**
- 3) To order a custom configuration which is not listed on page 8 and 9, use APP® custom part number configurator on the APP® website, www.andersonpower.com, or contact factory.

* Custom configurations may not be UL Recognized.

Wire Protection - PG Gland

SPECIFICATIONS

Material (Push-in Conduit)

| | |
|--------|----------|
| Shell | Nylon PA |
| Gasket | TPE |
| Color | Black |

Mechanical

| | |
|----------------|---------------------------------|
| Operating Temp | -30°C to 100°C (-22°F to 212°F) |
| IP Rating | IP68 |
| Thread Type | PG |

Material (All Others)

| | |
|--------|-------------------------|
| Shell | Nylon PA 66 (UL94 V-2)* |
| Gasket | EPDM |
| Color | Black |

Mechanical

| | |
|----------------|---------------------------------|
| Operating Temp | -40°C to 105°C (-40°F to 221°F) |
| IP Rating | IP68 |
| UV Rating | Equivalent to UL746C F1 |
| Thread Type | PG |

Torque Requirements

Cable Gland Body to Plug Housing
- Hand tighten until snug, tighten additional 1/8 - 1/4 turn with wrench

Sealing Nut to Cable
- Hand tighten until snug, tighten additional 1/2 - 3/4 turn with wrench



* Contact factory for UL94 V-0 material

NOTE: Only UL listed cable glands are UL recognized components when used with SPEC Pak® connector(s).

STRAIGHT PLASTIC SHORT THREAD TYPE - STD PACK 50 / UL LISTED

| Straight Gland Kit | | | | | | | | Right Angle Gland Kit | | | |
|--------------------|------------|--|---------------|-----------------|-------------------------------------|-------------------------|-----------------------------|--------------------------|---------------------------|------------------------------|--|
| APP® P/N | APP® P/N | Wire Protection Designation (4 Characters) | PG Gland Size | Number of Holes | Cable Range Wire Outer Dia. mm (in) | Thread O. D. C1 mm (in) | Panel Mounting Hole mm (in) | Thread Length C2 mm (in) | Wrench Size Lock Nut (mm) | Wrench Size Sealing Nut (mm) | |
| Right Angle | Straight | | | | | | | | | | |
| RPS1P21-16X | PS1P21-16X | PS01 | 21 | 1 | 16.2 - 10.5 (0.64 - 0.41) | 28.3 (1.11) | 28.3 - 28.7 (1.11 - 1.13) | 12 (0.47) | 36 | 33 | |
| RPS1P21-18X | PS1P21-18X | PS02 | 21 | 1 | 18.5 - 13 (0.73 - 0.51) | 28.3 (1.11) | 28.3 - 28.7 (1.11 - 1.13) | 12 (0.47) | 36 | 33 | |
| RPS1P29-22X | N/A | PS11 | 29 | 1 | 22 - 16 (0.86 - 0.63) | 37 (1.46) | 37 - 37.4 (1.46 - 1.47) | 12 (0.47) | 46 | 42 | |
| RPS1P29-25X | N/A | PS12 | 29 | 1 | 25 - 18 (0.98 - 0.71) | 37 (1.46) | 37 - 37.4 (1.46 - 1.47) | 12 (0.47) | 46 | 42 | |

STRAIGHT PLASTIC WITH FLEX SPRING - STD PACK 50 / UL LISTED

| APP® P/N | Wire Protection Designation (4 Characters) | Cable Range Wire Outer Dia. mm (in) | Thread O. D. C1 mm (in) | Panel Mounting Hole mm (in) | Thread Length C2 mm (in) | Wrench Size Lock Nut (mm) | Wrench Size Sealing Nut (mm) |
|------------|--|-------------------------------------|-------------------------|-----------------------------|--------------------------|---------------------------|------------------------------|
| Straight | | | | | | | |
| PF1P21-16X | PF01 | 15.8 - 10.5 (0.62 - 0.41) | 28.3 (1.11) | 28.3 - 28.7 (1.11 - 1.13) | 12 (0.47) | 36 | 33 |

LOCK NUT FOR PG 21 CABLE GLANDS

| APP® P/N | Wrench Size Lock Nut (mm) | Std. Pkg. Size |
|----------|---------------------------|----------------|
| 124G30 | 36 | 50 |

STRAIGHT PLASTIC MULTI-HOLE TYPE - STD PACK 50 / NOT UL LISTED

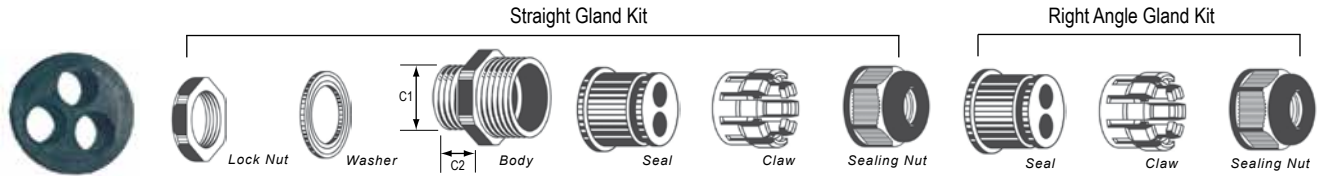

| APP® P/N | APP® P/N | Wire Protection Designation (4 Characters) | PG Gland Size | Number of Holes | Cable Range Wire Outer Dia. mm(in) | Thread O.D. C1 mm (in) | Panel Mounting Hole mm (in) | Thread Length C2 mm (in) | Wrench Size Lock Nut (mm) | Wrench Size Sealing Nut (mm) |
|------------|-----------|--|---------------|-----------------|------------------------------------|------------------------|-----------------------------|--------------------------|---------------------------|------------------------------|
| RPS2P21-5X | PS2P21-5X | PM21 | 21 | 2 | 5.2 - 3.6 (0.20 - 0.14) | 28.3 (1.11) | 28.3 - 28.7 (1.11 - 1.13) | 12.5 (0.49) | 36 | 33 |
| RPS2P21-6X | PS2P21-6X | PM22 | 21 | 2 | 6.5 - 5.1 (0.26 - 0.20) | 28.3 (1.11) | 28.3 - 28.7 (1.11 - 1.13) | 12.5 (0.49) | 36 | 33 |
| RPS2P21-8X | PS2P21-8X | PM23 | 21 | 2 | 8.7 - 6.4 (0.34 - 0.25) | 28.3 (1.11) | 28.3 - 28.7 (1.11 - 1.13) | 12.5 (0.49) | 36 | 33 |
| RPS3P21-5X | PS3P21-5X | PM31 | 21 | 3 | 5.2 - 3.6 (0.20 - 0.14) | 28.3 (1.11) | 28.3 - 28.7 (1.11 - 1.13) | 12.5 (0.49) | 36 | 33 |
| RPS3P21-6X | PS3P21-6X | PM32 | 21 | 3 | 6.2 - 4.8 (0.24 - 0.19) | 28.3 (1.11) | 28.3 - 28.7 (1.11 - 1.13) | 12.5 (0.49) | 36 | 33 |
| RPS3P21-8X | PS3P21-8X | PM33 | 21 | 3 | 8.0 - 6.2 (0.31 - 0.24) | 28.3 (1.11) | 28.3 - 28.7 (1.11 - 1.13) | 12.5 (0.49) | 36 | 33 |
| RPS4P21-3X | PS4P21-3X | PM41 | 21 | 4 | 3.1 - 2.0 (0.12 - 0.08) | 28.3 (1.11) | 28.3 - 28.7 (1.11 - 1.13) | 12.5 (0.49) | 36 | 33 |
| RPS4P21-4X | PS4P21-4X | PM42 | 21 | 4 | 4.1 - 3.0 (0.16 - 0.12) | 28.3 (1.11) | 28.3 - 28.7 (1.11 - 1.13) | 12.5 (0.49) | 36 | 33 |
| RPS4P21-5X | PS4P21-5X | PM43 | 21 | 4 | 5.2 - 3.8 (0.20 - 0.15) | 28.3 (1.11) | 28.3 - 28.7 (1.11 - 1.13) | 12.5 (0.49) | 36 | 33 |
| RPS4P21-7X | PS4P21-7X | PM44 | 21 | 4 | 7.3 - 5.6 (0.29 - 0.22) | 28.3 (1.11) | 28.3 - 28.7 (1.11 - 1.13) | 12.5 (0.49) | 36 | 33 |
| RPS5P21-3X | PS5P21-3X | PM51 | 21 | 5 | 3.6 - 2.6 (0.14 - 0.10) | 28.3 (1.11) | 28.3 - 28.7 (1.11 - 1.13) | 12.5 (0.49) | 36 | 33 |
| RPS5P21-4X | PS5P21-4X | PM52 | 21 | 5 | 4.6 - 3.6 (0.18 - 0.14) | 28.3 (1.11) | 28.3 - 28.7 (1.11 - 1.13) | 12.5 (0.49) | 36 | 33 |
| RPS5P21-6X | PS5P21-6X | PM53 | 21 | 5 | 6.0 - 4.6 (0.24 - 0.18) | 28.3 (1.11) | 28.3 - 28.7 (1.11 - 1.13) | 12.5 (0.49) | 36 | 33 |
| RPS6P21-3X | PS6P21-3X | PM61 | 21 | 6 | 3.6 - 2.6 (0.14 - 0.10) | 28.3 (1.11) | 28.3 - 28.7 (1.11 - 1.13) | 12.5 (0.49) | 36 | 33 |
| RPS6P21-5X | PS6P21-5X | PM62 | 21 | 6 | 5.2 - 3.6 (0.20 - 0.14) | 28.3 (1.11) | 28.3 - 28.7 (1.11 - 1.13) | 12.5 (0.49) | 36 | 33 |

STRAIGHT CONDUIT ADAPTER THREAD TYPE - STD PACK 50 / NOT UL LISTED

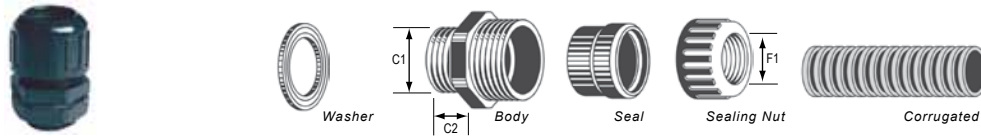

| APP® P/N | Wire Protection Designation (4 Characters) | Max. Joint F1 mm (in) | Thread O.D. C1 mm (in) | Panel Mounting Hole mm (in) | Thread Length C2 mm (in) | Wrench Size Lock Nut (mm) | APP® Conduit P/N | Conduit O. D. |
|------------|--|-----------------------|------------------------|-----------------------------|--------------------------|---------------------------|------------------|---------------|
| CT1P21-21X | CT02 | 22.0 (0.87) | 28.3 (1.11) | 28.3 - 28.7 (1.11 - 1.13) | 12 (0.47) | 36 | NGN - 17B | 21.2 (0.83) |
| CT1P21-26X | CT03 | 26.5 (1.04) | 28.3 (1.11) | 28.3 - 28.7 (1.11 - 1.13) | 12 (0.47) | 36 | NGN - 22B | 26.2 (1.03) |
| CT1P21-28X | CT04 | 28.5 (1.12) | 28.3 (1.11) | 28.3 - 28.7 (1.11 - 1.13) | 12 (0.47) | 36 | NGN - 23B | 28.5 (1.12) |

STRAIGHT CONDUIT PUSH-IN TYPE - STD PACK 50 / NOT UL LISTED

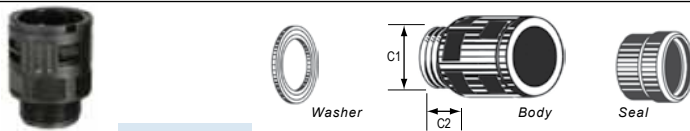

| APP® P/N | Wire Protection Designation (4 Characters) | Thread O.D. C1 mm (in) | Panel Mounting Hole mm (in) | Thread Length C2 mm (in) | Wrench Size Lock Nut (mm) | APP® Conduit P/N | Conduit O. D. |
|-----------|--|------------------------|-----------------------------|--------------------------|---------------------------|------------------|---------------|
| CAP21-28X | CA04 | 28.3 (1.11) | 28.3 - 28.7 (1.11 - 1.13) | 12 (0.5) | 36 | NGN - 23B | 28.5 (1.12) |

CORRUGATED NYLON PLASTIC TUBING

| APP® P/N | Conduit I. D. mm (in) | Conduit O. D. mm (in) | Conduit Size | Trade Size (mm) | Std. Pkg. Meters (Feet) |
|-----------|-----------------------|-----------------------|--------------|-----------------|-------------------------|
| NGN - 17B | 16.7 (0.66) | 21.2 (0.83) | 1/2" | OD21.2 | 50 (164) |
| NGN - 22B | 21.2 (0.83) | 26.2 (1.03) | - | - | 50 (164) |
| NGN - 23B | 21.7 (0.85) | 28.5 (1.12) | 3/4" | OD28.5 | 50 (164) |

TUBING CUTTER



| APP® P/N | Description | Range (mm) |
|----------|----------------------------------|---------------|
| TM0002 | Corrugated Plastic Tubing Cutter | Up to OD 34.5 |

Standard Housing Arrangements & Contacts

HOUSING ARRANGEMENTS FOR POWER, SIGNAL & GROUND CONNECTORS

ARRANGEMENTS REPRESENT FRONT VIEW OF RECEPTACLE

Custom configurations may be created using APP's part number configurator at www.andersonpower.com

E = Empty 1327 Series = Power 1827 Series = Ground 4800 Series = Signal

0 Custom Configuration

AC Single Phase

| | | |
|----------|----------|--------|
| A | 1327G6FP | E |
| | E | 1827G1 |
| | 1327G7FP | E |

AC 3 Phase, 3 Wire

| | | |
|----------|----------|--------|
| B | 1327G6FP | E |
| | 1327G7FP | 1827G1 |
| | 1327FP | E |

DC 2 Circuit, 4 Wire

| | | |
|----------|----------|----------|
| C | 1327G6FP | 1327G6FP |
| | E | E |
| | 1327FP | 1327FP |

DC 2 Circuit, 4 Wire
With Ground

| | | |
|----------|----------|----------|
| D | 1327G6FP | 1327G6FP |
| | E | 1827G1 |
| | 1327FP | 1327FP |

AC 3 Phase, 4 Wire

| | | |
|----------|----------|----------|
| E | 1327G6FP | 1327G8FP |
| | 1327G7FP | 1827G1 |
| | 1327FP | E |

AC 3 Phase, 5 Wire

| | | |
|----------|----------|-----------|
| F | 1327G6FP | 1327G8FP |
| | 1327G7FP | 1827G1 |
| | 1327FP | 1327G16FP |

DC 2 Circuit, 6 Wire

| | | |
|----------|--------|----------|
| G | 1327FP | 1327G6FP |
| | 1327FP | 1327G6FP |
| | 1327FP | 1327G6FP |

DC 2 Circuit, 4 Wire
With 8 Signal

| | | |
|----------|----------|----------|
| H | 1327G6FP | 1327G6FP |
| | 4827G6 | 4827G6 |
| | 1327FP | 1327FP |

AC Single Phase With 4 Signal

| | | |
|----------|----------|--------|
| J | 1327G6FP | E |
| | E | 1827G1 |
| | 1327G7FP | 4827G6 |

AC 3 Phase, 3 Wire
With 4 Signal

| | | |
|----------|----------|--------|
| K | 1327G6FP | E |
| | 1327G7FP | 1827G1 |
| | 1327FP | 4827G6 |

DC 2 Circuit, 4 Wire
With 4 Signal

| | | |
|----------|----------|----------|
| L | 1327G6FP | 1327G6FP |
| | E | 4827G6 |
| | 1327FP | 1327FP |

AC 3 Phase, 3 Wire
With 8 Signal

| | | |
|----------|----------|----------|
| M | 1327FP | 1327G7FP |
| | 4827G6 | 4827G6 |
| | 1327G6FP | 1827G1 |

DC 2 Circuit, 4 Wire
With Ground & 4 Signal

| | | |
|----------|----------|----------|
| N | 1327G6FP | 1327G6FP |
| | 4827G6 | 1827G1 |
| | 1327FP | 1327FP |

AC 3 Phase, 4 Wire
With 4 Signal

| | | |
|----------|----------|----------|
| P | 1327G6FP | 1327G8FP |
| | 1327G7FP | 1827G1 |
| | 1327FP | 4827G6 |

All Signal

| | | |
|----------|--------|--------|
| X | 4827G6 | 4827G6 |
| | 4827G6 | 4827G6 |
| | 4827G6 | 4827G6 |

CONTINUOUS CURRENT RATINGS - POWER CONTACT CODE SELECTION

| Contact Code | Power Contacts | Housing Configuration | Wire Size / Current Rating | | | | | |
|--------------|-------------------------------|-----------------------|----------------------------|-------|-------|-------|-------|------|
| | | | #10 | #12 | #14 | #16 | #18 | #20 |
| 00 | Contacts Purchased Separately | | | | | | | |
| 01 | 261G2 | A - C | 29/40 | 20/33 | 15/23 | — | — | — |
| | | D - G | 24/36 | 20/25 | 15/21 | — | — | — |
| | | H - P | 29/40 | 20/33 | 15/22 | — | — | — |
| 02 | 200G1L | A - C | 27/37 | 20/32 | 15/22 | — | — | — |
| | | D - G | 22/33 | 18/25 | 15/20 | — | — | — |
| | | H - P | 27/37 | 20/32 | 15/22 | — | — | — |
| 03 | 261G1 | A - C | — | 20/33 | 15/23 | 12/18 | — | — |
| | | D - G | — | 20/25 | 15/21 | 12/18 | — | — |
| | | H - P | — | 20/33 | 15/22 | 12/18 | — | — |
| 04 | 1331 | A - C | — | 17/25 | 15/25 | 13/20 | — | — |
| | | D - G | — | 15/25 | 15/22 | 13/18 | — | — |
| | | H - P | — | 17/25 | 15/20 | 13/20 | — | — |
| 05 | 262G1 | A - C | — | — | — | 12/18 | 10/15 | 7/10 |
| | | D - G | — | — | — | 12/18 | 8/13 | 6/9 |
| | | H - P | — | — | — | 12/18 | 10/15 | 7/10 |
| 06 | 1332 | A - C | — | — | — | 13/20 | 9/14 | 6/9 |
| | | D - G | — | — | — | 13/18 | 7/12 | 5/8 |
| | | H - P | — | — | — | 13/20 | 9/14 | 6/9 |

NOTES:

- Current ratings:
 - First number represents current rating per pole for 30°C temperature rise (29 / 40)
 - Second number is the maximum recommended current per pole based on a 25°C ambient (29 / 40)
- Configuration H - P based on signal contacts crimped to #20 AWG wire and carrying 1 amp
- ☐ Denotes wire size not appropriate for power contact
- Shaded boxes ☐ are c  File No. E26226 pending.
- 1827G1 housing with 1830G1 or 1830G2 ground contact depending on primary contacts (see chart above). All signal housing kits (4850G6) come with two 4802G3 and two 4802G3 contacts.

HOLDER LOCATIONS (VIEWS)

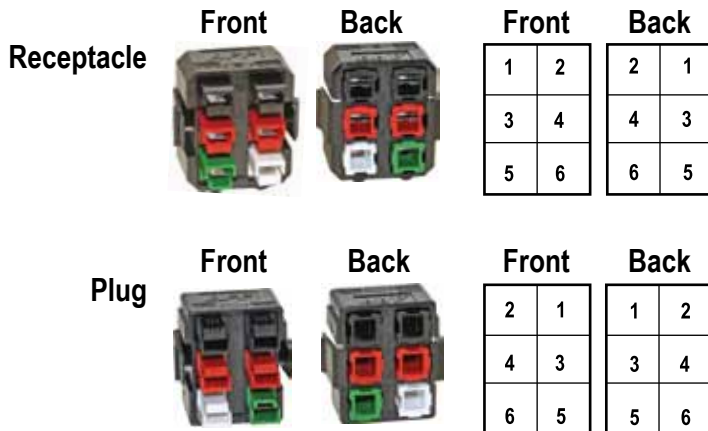

TEMPERATURE CHART

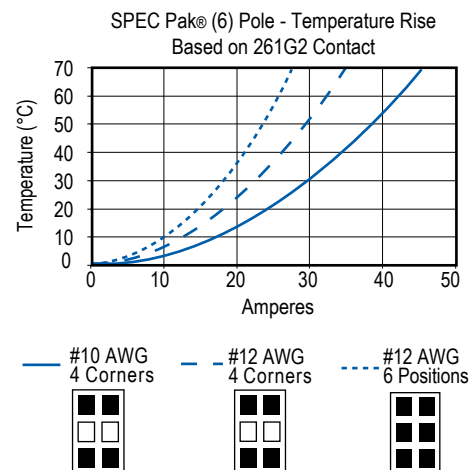

Individual Components

POWERPOLE® HOUSINGS & CONTACTS

Fingerproof PP15/45 Housing Only

Package Quantity:

Standard, 100 pieces - Bulk, 1,000 pieces

| Standard Part Number | Bulk Part Number | Description |
|----------------------|------------------|----------------|
| 1327FP | 1327FP-BK | Red Housing |
| 1327G5FP | 1327G5FP-BK | Green Housing |
| 1327G6FP | 1327G6FP-BK | Black Housing |
| 1327G7FP | 1327G7FP-BK | White Housing |
| 1327G8FP | 1327G8FP-BK | Blue Housing |
| 1327G16FP | 1327G16FP-BK | Yellow Housing |

Standard PP 15/45 Housing Only

Package Quantity:

Standard, 100 pieces - Bulk, 1,000 pieces

| Standard Part Number | Bulk Part Number | Description |
|----------------------|------------------|----------------|
| 1327 | 1327-BK | Red Housing |
| 1327G5 | 1327G5-BK | Green Housing |
| 1327G6 | 1327G6-BK | Black Housing |
| 1327G7 | 1327G7-BK | White Housing |
| 1327G8 | 1327G8-BK | Blue Housing |
| 1327G16 | 1327G16-BK | Yellow Housing |
| 1327G17 | 1327G17-BK | Orange Housing |
| 1327G18 | 1327G18-BK | Gray Housing |
| 1327G21 | 1327G21-BK | Brown Housing |
| 1327G22 | 1327G22-BK | Pink Housing |
| 1327G23 | 1327G23-BK | Purple Housing |

Premate Ground PP15/45 Housing Only

Package Quantity:

Standard, 100 pieces - Bulk, 1,000 pieces

| Standard Part Number | Bulk Part Number | Description |
|----------------------|------------------|---------------|
| 1827G1 | 1827G1-BK | Green Housing |

Premate Ground Contacts

Loose Piece

Package Quantity 100

| Part Number | Description |
|--|----------------------------|
| #10 to #14 AWG (4 to 1.5 mm ²) | |
| 1830G1-LPBK | Singulated-LD-Tin Plate |
| 1830G2-LPBK | Singulated-LD-Silver Plate |

Reel

Package Quantity 5,000

| Part Number | Description |
|--|----------------------|
| #10 to #14 AWG (4 to 1.5 mm ²) | |
| 1830G1 | Reel-LD-Tin Plate |
| 1830G2 | Reel-LD-Silver Plate |

15/45 Powerpole® Contacts

Loose Piece

Package Quantity:

Standard, 100 pieces - Bulk, 1,000 pieces

| Standard Part Number | Bulk Part Number | Description |
|--|------------------|------------------------------------|
| #16 to #20 AWG (1.0 to 0.5 mm ²) | | |
| 1332 | 1332-BK | Individual-LD-Silver Plate |
| 262G1-LPBK | - | Singulated Reel-LD-Tin Plate |
| 262G2-LPBK | - | Singulated Reel-LD-Silver Plate |
| #12 to #16 AWG (2.5 to 1.0 mm ²) | | |
| 1331 | 1331-BK | Individual-LD-Silver Plate |
| 261G1-LPBK | - | Singulated Reel-LD-Tin Plate |
| #10 to #14 AWG (4 to 1.5 mm ²) | | |
| 261G2-LPBK | - | Singulated Reel-LD-Tin Plate |
| 261G3-LPBK | - | Singulated Reel-LD-Silver Plate |
| 200G1L-LPBK | - | Superflex, Sing. Reel-LD-Tin Plate |

Reel - 15/45 Powerpole® Contacts

Package Quantity 5,000

| Part Number | Description |
|--|------------------------------|
| #16 to #20 AWG (1.0 to 0.5 mm ²) | |
| 262G1 | Reel-LD-Tin Plate |
| 262G2 | Reel-LD-Silver Plate |
| #12 to #16 AWG (2.5 to 1.0 mm ²) | |
| 261G1 | Reel-LD-Tin Plate |
| #10 to #14 AWG (4 to 1.5 mm ²) | |
| 261G2 | Reel-LD-Tin Plate |
| 261G3 | Reel-LD-Silver Plate |
| #10 to #14 AWG (6 to 1.5mm ²) | |
| 200G1L | SuperFlex, Reel-LD-Tin Plate |

NOTE:

LD - Low Detent

For additional housing colors please contact customer service.

CONTACT STYLES

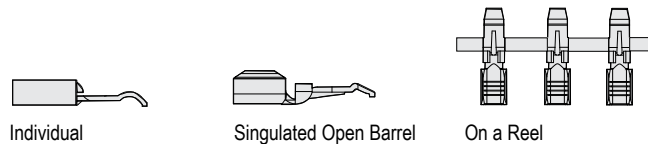

PPMX (4800 SERIES) HOUSING & CONTACTS

PPMX Housing

Package Quantity

Standard, 25 pieces - Bulk, 1,000 pieces

| Standard Part Number | Bulk Part Number | Description |
|----------------------|------------------|-------------------------|
| 4827G6 | 4827G6-BK | Black two piece housing |

PPMX Contacts

Package Quantity

Standard, 50 pieces - Bulk, 2,000 pieces

Loose Piece

#20 to #24 AWG (0.50 to 0.25 mm²)

| Standard Part Number | Bulk Part Number | Description |
|----------------------|------------------|-------------------------------|
| 4802G3 | 4802G3-BK | Socket, Gold, 50 Micro-inches |
| 4803G3 | 4803G3-BK | Pin, Gold, 50 Micro-inches |

PPMX Housing & Contact Kits

Package Quantity

Standard, 100 pieces

1 Black two piece housing, 2 Male Contacts,
2 Female Contacts

| Standard Part Number | Bulk Part Number | Description |
|----------------------|------------------|---|
| 4850G6 | - | 50 Micro-inches Gold Plated Contacts - Pin & Socket |

PP15/45 POWERPOLE® HOUSING STYLES

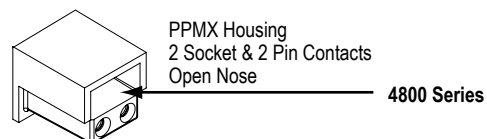
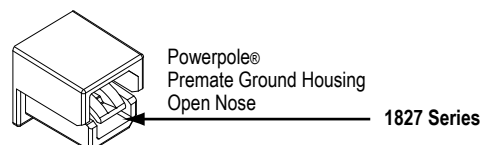

APPLICATION TOOLING - POWERPOLE® 15 / 45 CONTACTS

| Loose Piece Tin Part Number | Loose Piece Silver Part Number | Hand Tool or Pneumatic Tool | | Reeled Tin Part Number | Reeled Silver Part Number | ATS Applicator |
|-----------------------------|--------------------------------|-----------------------------|----------------|------------------------|---------------------------|----------------|
| | | Hand Tool | Pneumatic Tool | | | |
| N/A | 1332 | 1309G2 or 1309G8 | 1367G1 | N/A | N/A | N/A |
| N/A | 1331 | | | N/A | N/A | N/A |
| 262G1-LPBK | 262G2-LPBK | | | N/A | N/A | 261G1 |
| 200G2L-LPBK | 200G4L-LPBK | TBD | | | | |
| 261G1-LPBK | 261G4-LPBK | 1385520 | | | | |
| 261G2-LPBK | 261G3-LPBK | 1385458 | | | | |
| 200G1L-LPBK | 200G3L-LPBK | 1385460 | | | | |
| 1830G1-LPBK | 1830G2-LPBK | 1385460 | | | | |

* All Hand and Pneumatic Tools for use with Loose Piece contacts only. All reeled contacts can be ordered singulated, (Loose Piece) with the suffix "- LPBK"

** 1309G8 is a hand tool kit- includes dies and locators to make up 1309G2, 1309G3, & 1309G6

APPLICATION TOOLING - PPMX CONTACTS

| Contact Part Number | Mil Std. Hand Tool | | | Pneumatic Tool for Locator / Turret |
|---------------------|--------------------|----------------------------|----------------------|-------------------------------------|
| | APP® Hand Tool or | Mil Std. Tool (APP Part #) | Positioner | |
| 4802G3 | PM1000G1 | M22520/1-01 (TM0001) | No Mil Std. (TL0005) | TP0001 |
| 4803G3 | | | | |

Dimensions

PLUG 6 POSITION FOR PP15/45 HOUSINGS

Top View

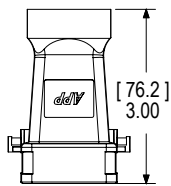

Front View

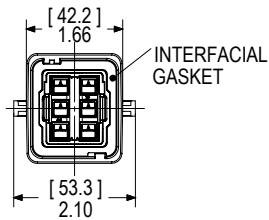

Side View

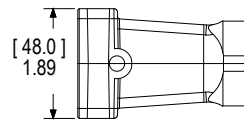

Mated Side View

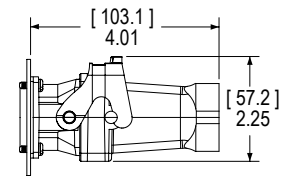

RIGHT ANGLE PLUG 6 POSITION FOR PP15/45 - GLAND SIZE PG 21

Top View

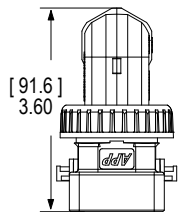

Front View

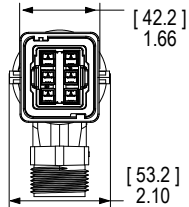

Side View

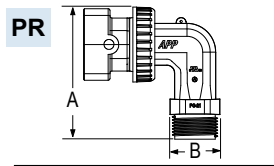

| PG Gland | - A - mm | in. | - B - mm | in. |
|----------|-------------|------|-------------|------|
| PG 21 | 104.7 | 4.12 | 36.4 | 1.43 |
| PG 29 | 105.5 | 4.15 | 47.4 | 1.86 |

Mated Side View

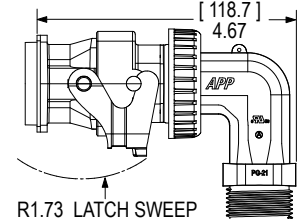

For PG 29 dimensions, please see APP website

RECEPTACLE 6 POSITION FOR PP15/45 HOUSINGS

Panel Cut Out

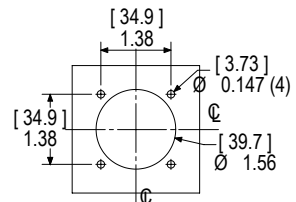

PANEL CUT OUT \varnothing

(SAME AS 26482 & 5015 SHELL SIZE 24)

Front View

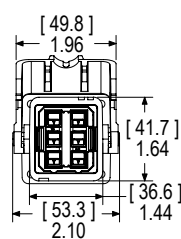

Side View

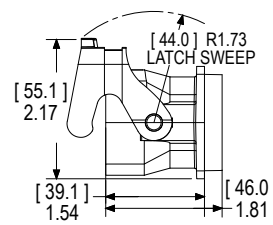

Back View

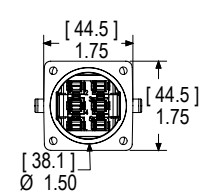

NOTE: Mounting hardware #6 screw / torque receptacle to panel 3/2 to 5 in-lbf (0.4 to 0.56 Nm)

PG GLANDS

PS

Plastic Short

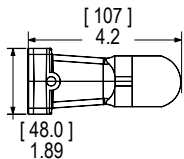

CT

Thread Conduit Adapter

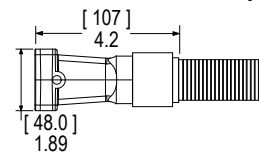

PF

Plastic Flex PG

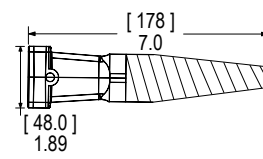

CA

Push-in Conduit Adapter

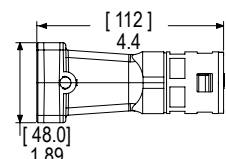

RECEPTACLE COVER KIT

Front View

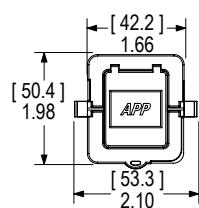

Side View

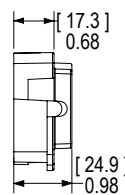

Mated Side View

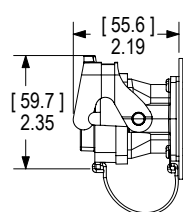

All Data Subject To Change Without Notice

Patents

15052 DS-SPAK REV06

HEADQUARTERS: Anderson Power Products®, 13 Pratts Junction Road, Sterling, MA 01564-2305 USA T:978-422-3600 F:978-422-0128

EUROPE: Anderson Power Products® Ltd., Unit 3, Europa Court, Europa Boulevard, Westbrook, Warrington, Cheshire, WA5 7TN United Kingdom T: +44 (0) 1925 428390 F: +44 (0) 1925 520203

ASIA / PACIFIC: IDEAL Anderson Asia Pacific Ltd., Unit 922-928 Topsail Plaza, 11 On Sum Street, Shatin N.T., Hong Kong T: +(852) 2636 0836 F: +(852) 2635 9036

CHINA: IDEAL Anderson Technologies (Shenzhen) Ltd., Block A8 Tantou Western Industrial Park, Songgang Baoan District, Shenzhen, P.R. China 518105 T: +(86) 755 2768 2118 F: +(86) 755 2768 2218

TAIWAN: IDEAL Anderson Asia Pacific Ltd., Taiwan Branch, 4F-2, No.116, Dadun 20th St., Situn District, Taichung City 407, Taiwan (R.O.C.) T: +(886) 4 2310 6451 F: +(886) 4 2310 6460

www.andersonpower.com

Mouser Electronics

Authorized Distributor

Click to View Pricing, Inventory, Delivery & Lifecycle Information:

Anderson Power Products:

[114765P1](#) [B02047P1](#) [SK6-053B06PS02-B03](#) [SK6-053B06PS02-B04](#) [SK6-053B06PS02-C02](#) [SK6-053B06PS02-C03](#) [SK6-053B06PS02-D02](#) [SK6-053B06PS02-D04](#) [SK6-053B06PS02-D06](#) [SK6-053B06PS02-E01](#) [SK6-053B06PS02-E04](#) [SK6-053B06PS02-F06](#) [SK6-053B06PS02-G01](#) [SK6-053B06PS02-G03](#) [SK6-053B06PS02-G04](#) [SK2-053B060000-G06](#) [SK2-053B060000-G01](#) [SK2-053B060000-G04](#) [SK2-053B060000-H01](#) [SK6-053B060000-A03](#) [SK6-053B060000-A04](#) [SK6-053B060000-A06](#) [SK6-053B060000-B02](#) [SK6-053B060000-C01](#) [SK6-053B06CT04-A03](#) [SK6-053B06CT04-B01](#) [SK6-053B06CT04-B03](#) [SK6-053B06CT04-C01](#) [SK6-053B06CT04-C02](#) [SK6-053B06CT04-D01](#) [SK6-053B06CT04-D04](#) [SK6-053B06CT04-D02](#) [SK6-053B06CT04-E03](#) [SK6-053B06CT04-E04](#) [SK6-053B06CT04-G03](#) [SK6-053B06CT04-G04](#) [SK6-053B06PF01-A04](#) [SK6-053B06PF01-B01](#) [SK6-053B06PF01-C01](#) [SK6-053B06PF01-D01](#) [SK6-053B06PF01-D02](#) [SK6-053B06PF01-E04](#) [SK6-053B06PF01-E06](#) [SK6-053B06PF01-F01](#) [SK6-053B06PF01-F02](#) [SK6-053B06PF01-F03](#) [SK6-053B06PF01-F04](#) [SK6-053B06PF01-G02](#) [SK6-053B06PF01-G03](#) [SK6-053B06PF01-G04](#) [SK6-053B06PF01-G06](#) [SK6-053B06PS02-A01](#) [SK6-053B06PS02-A03](#) [SK6-053B06PS02-A06](#) [SK6-053B06PS02-B02](#) [SK6-053B060000-B03](#) [SK6-053B060000-B04](#) [SK6-053B060000-B06](#) [SK6-053B060000-C02](#) [SK2-053B060000-N02](#) [SK2-053B060000-A02](#) [SK2-053B060000-A03](#) [SK2-053B060000-A06](#) [SK2-053B060000-B01](#) [SK2-053B060000-B04](#) [SK2-053B060000-C02](#) [SK2-053B060000-C03](#) [SK2-053B060000-C04](#) [SK2-053B060000-D01](#) [SK2-053B060000-E03](#) [SK2-053B060000-E04](#) [SK2-053B060000-F01](#) [SK6-053B060000-C04](#) [SK6-053B060000-C06](#) [SK6-053B060000-D01](#) [SK6-053B060000-D02](#) [SK6-053B060000-D04](#) [SK6-053B060000-E01](#) [SK6-053B060000-E02](#) [SK6-053B060000-E03](#) [SK6-053B060000-E06](#) [SK6-053B060000-F02](#) [SK6-053B060000-F03](#) [SK6-053B060000-F04](#) [SK6-053B060000-F06](#) [SK6-053B060000-G02](#) [SK6-053B060000-G03](#) [SK2-053B060000-F06](#) [SK2-053B060000-G02](#) [SK2-053B060000-G03](#) [SK6-053B060000-A01](#) [SK6-053B060000-A02](#) [SK6-053B060000-B01](#) [SK6-053B06PF01-E02](#) [SK6-053B06PF01-E03](#) [SK6-053B06PF01-F06](#) [SK6-053B06PF01-G01](#) [SK6-053B06PF01-H01](#) [SK6-053B06PS02-A02](#) [SK6-053B06PS02-A04](#)



Компания «ЭлектроПласт» предлагает заключение долгосрочных отношений при поставках импортных электронных компонентов на взаимовыгодных условиях!

Наши преимущества:

- Оперативные поставки широкого спектра электронных компонентов отечественного и импортного производства напрямую от производителей и с крупнейших мировых складов;
- Поставка более 17-ти миллионов наименований электронных компонентов;
- Поставка сложных, дефицитных, либо снятых с производства позиций;
- Оперативные сроки поставки под заказ (от 5 рабочих дней);
- Экспресс доставка в любую точку России;
- Техническая поддержка проекта, помощь в подборе аналогов, поставка прототипов;
- Система менеджмента качества сертифицирована по Международному стандарту ISO 9001;
- Лицензия ФСБ на осуществление работ с использованием сведений, составляющих государственную тайну;
- Поставка специализированных компонентов (Xilinx, Altera, Analog Devices, Intersil, Interpoint, Microsemi, Aeroflex, Peregrine, Syfer, Eurofarad, Texas Instrument, Miteq, Cobham, E2V, MA-COM, Hittite, Mini-Circuits, General Dynamics и др.);

Помимо этого, одним из направлений компании «ЭлектроПласт» является направление «Источники питания». Мы предлагаем Вам помощь Конструкторского отдела:

- Подбор оптимального решения, техническое обоснование при выборе компонента;
- Подбор аналогов;
- Консультации по применению компонента;
- Поставка образцов и прототипов;
- Техническая поддержка проекта;
- Защита от снятия компонента с производства.



Как с нами связаться

Телефон: 8 (812) 309 58 32 (многоканальный)

Факс: 8 (812) 320-02-42

Электронная почта: org@eplast1.ru

Адрес: 198099, г. Санкт-Петербург, ул. Калинина, дом 2, корпус 4, литера А.