



Industrial



### FEATURES AND BENEFITS

1500W Fan-Cooled (Load & Temperature Controlled)	Remote Setting Multiple PSU via RS232, RS485 & I <sup>2</sup> C
Programmable Output Voltage (0% ~ 105%)	Power OK Signal
Programmable Output Current (0% ~ 105%)	Remote ON/OFF, Remote Sense Function
Forced Current Sharing at Parallel Operation	Protection: OVP, OLP, OTP, Fan Failure
Constant Current Limit	3 Year Warranty
Selectable +5V/0.5A or +9V/0.3A Auxiliary Output	RoHS Compliant
	Global Control via RS232

### MODEL SELECTION

Model Number <sup>4</sup>	Output Volts	Rated Current	Current Range	Output Power	Ripple & Noise <sup>1</sup>	Line Regulation	Load Regulation	Voltage Tolerance <sup>3</sup>	Efficiency
TF1500A12K	12V	125A	0-125A	1500W	150mV pk-pk	±1%	±1%	±2%	89%
TF1500A15K	15V	100A	0-100A	1500W	150mV pk-pk	±1%	±1%	±2%	90%
TF1500A24K	24V	62.5A	0-62.5A	1500W	240mV pk-pk	±1%	±1%	±2%	92%
TF1500A48K	48V	31.37A	0-31.3A	1500W	480mV pk-pk	±1%	±1%	±2%	92%
TF1500A60K	60V	25.0A	0-25A	1500W	600mV pk-pk	±1%	±1%	±2%	93%

- Notes :**
- See CMD VS Output Curve.
  - Ripple & noise are measured at 20MHz of bandwidth by using a 12" twisted pair-wire terminated with a 0.1uF & 47uF parallel capacitor.
  - Tolerance: includes setup time tolerance, line regulation and load regulation.

- Other output voltages available, consult factory.
- Recovery after reset AC power ON or inhibit.
- All specifications are typical at 230Vac, full load, at 25°C ambient unless noted.

### INPUT

Input Voltage and Frequency <sup>1</sup>	100-240Vac, ±10%, 47-63Hz, 1Ø127-370Vdc
Input Current	115Vac: 18A, 230Vac: 9A
Inrush Current	30A/115VAC, 60A/230VAC
Efficiency	See Model Selection Table
Power Factor	0.95/230VAC, 0.99/115VAC at full load
Leakage Current	< 2.5mA/240VAC

- Notes :**
- De-rating may apply in low input voltage. Please check the de-rating curve for more details

### OUTPUT

Output Voltage	See Model Selection Table on pg 1
Output Power <sup>1</sup>	1500W continuous – See model selection table for specific voltage model ratings.
Voltage Range	±5.0% Typical adjustment by potentiometer (VR1)
Voltage Tolerance	See Model Selection Table on pg 1
Hold-Up Time	14ms/230VAC at full load
Turn On Time	800ms
Rise Time	100ms at full load
Ripple and Noise	See Model Selection Table on pg 1
Line/Load Regulation	See Model Selection Table on pg 1

- Notes :**
- De-rating may apply in low input voltage. Please check the de-rating curve for more details

### CONNECTOR INFORMATION

	Input Connector	Output Connector	Signal Connector
Pinout:	Term. 1) AC LINE Term. 2) NEUTRAL Term. 3) GROUND	+ and -	See Signal Connector Table on pg 3.
Mating Connector /terminal:	#10 wire lugs	1/4-20 Wire Lugs	Connector: JST PHDR-24VS or equivalent Pins: JST SPHD-002T-P0.5 or equivalent



### EMI/EMC COMPLIANCE

Conducted Emissions	Certified EN 55022; EN 61204-3; EN 61000-6-3
Radiated Emissions	Certified EN 55022; EN 61204-3; EN 61000-6-3
Electro-Static Discharge (ESD) Immunity on Power ports	EN55024/IEC61000-4-2
Radiated RF EM Fields Susceptibility	EN55022/EN61000-4-3
Electrical Fast Transients (EFT) /Bursts	EN55024/IEC61000-4-4
Surges, Line to Line (Diff Mode) and Line to GND (CMN Mode)	EN55024/IEC61000-4-5
Conducted Disturbances induced by RF Fields	EN55022/IEC61000-4-6
Rated Power frequency magnetic fields	EN55024/IEC1000-4-8
Voltage Interruptions, Dips, Sags & Surges	EN55024/IECEN61000-4-11
Harmonic Current Emissions	EN61000-3-2
Flicker Test	EN61000-3-3

Notes : 1. The power supply is considered a component which will be installed into a final equipment. The final equipment must be re-confirmed that it still meets EMC directives.

### SAFETY

Safety Certifications	UL60950-1, EN60950-1
-----------------------	----------------------

### RELIABILITY

MTBF	>112,000 hours per MIL-HDBK-217F
------	----------------------------------

### ENVIRONMENT

Operating Temperature	-25 ~ +60°C (Refer to load derating curve)
Temperature Derating	See Derating Curve
Vibration	10 ~ 500Hz, 2G 10min./1 cycle, period for 60min. each along X, Y, Z axes Compliance to IEC 68-2-6, IEC 68-2-64
Dimensions	127 x 64 x 280mm 5.0 x 2.5 x 11.02 inch
Cooling	Load and temperature control fan
Relative Humidity	20% to 90%, non-condensing
Storage Temperature and Humidity	-40 ~ +85°C, 10 ~ 95% RH
Weight & Packing	2.6kg 6pcs/carton, 16.6kg/1.86CUFT

### AUXILIARY SIGNALS

Auxiliary Power	Selectable +5V/0.5A or +9V/0.3A auxiliary output
Remote ON / OFF Control	By external switch
Power OK Signal	Open drain signal low when PSU turns on, Max. sink current: 20mA, Max. drain voltage: 40V
Output Voltage Trim	Adjustment of output voltage is between 0 ~ 105% of rated output
Output Current Trim	Adjustment of output current is between 0 ~ 105% of rated output
Parallel (Current Sharing) <sup>1</sup>	Please refer to Current Sharing with Remote Sensing (Parallel Connection) Diagram

Notes : 1. In parallel connection only one unit will operate if the total output load is less than 5% of the rated power.

### PROTECTION

Overvoltage Protection	120 ± 7% of Vout, Latch Type (Recovery after reset AC power ON or inhibit). (Refer to VCI vs. OVP Curve)
Short Circuit Protection	Constant current, auto-recovery
Overtemperature Protection	85±5°C measured on NTC. Auto recovery
Overload Protection	105% of rated power, constant current type

### ISOLATION SPECIFICATIONS

Isolation <sup>1</sup>	Input-Output: 3000Vac Input-Ground: 1500Vac Output-Ground: 500Vac
Isolation Resistance	I/P-O/P, I/P-FG, O/P-FG: 100M Ohms/500VDC

Notes : 1. This test is done without enclosure: I/P-O/P 4242VDC. If with enclosure: I/P-O/P 2121VDC, I/P-FG:2121VDC, O/P-FG: 707VDC



### MECHANICAL DRAWING

Unit : mm/inch

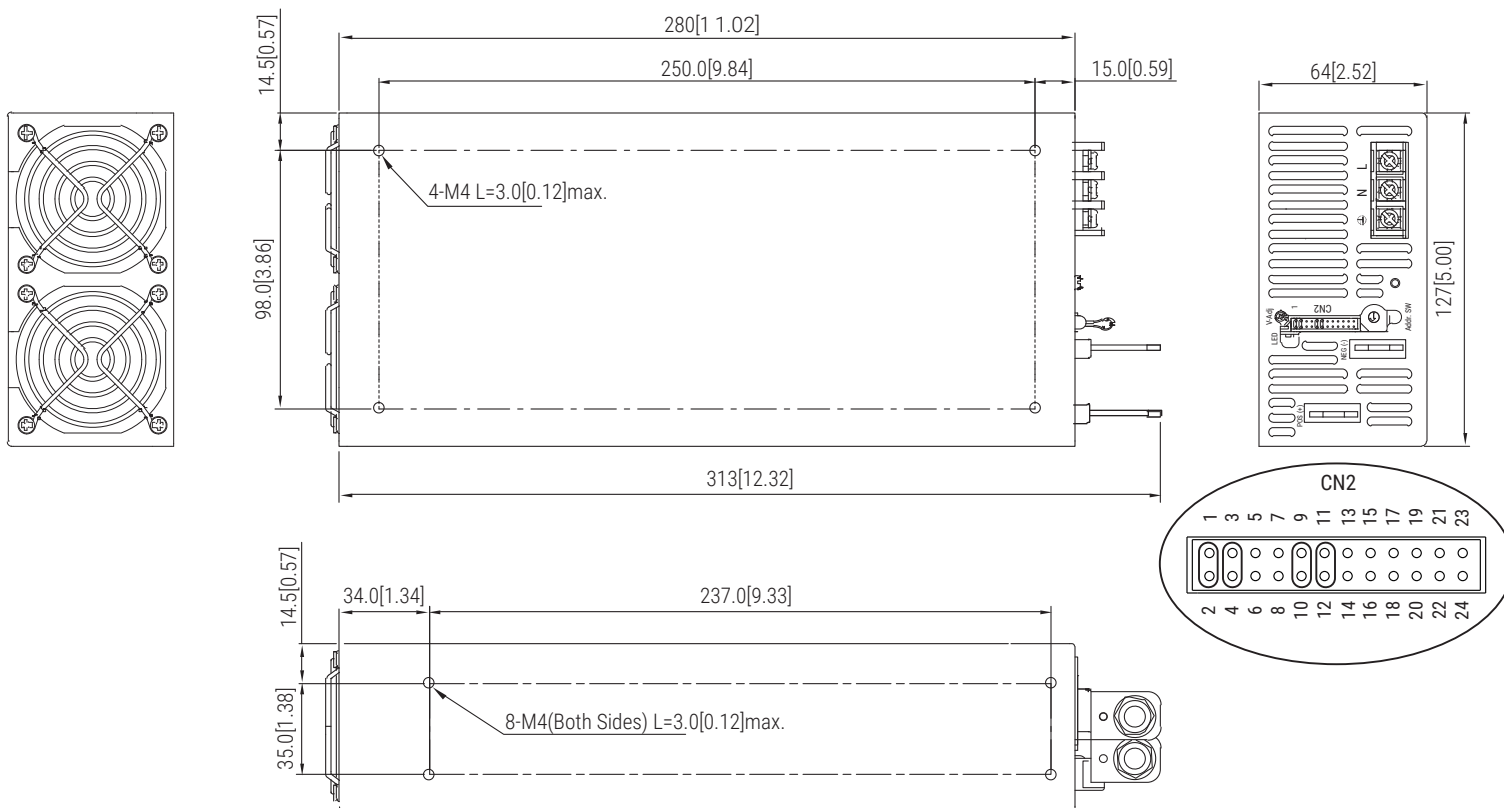









Recommended screw length is measured from the power supply surface.

### SIGNAL CONNECTOR

Pin No.	Function	Description	Pin No.	Function	Description
1	VS+	Remote sense (+)	13	ACI	I Program
2	VO+	Positive output voltage	14	GND	Ground
3	VS-	Remote sense (-)	15	VCI	V Program
4	VO-	Negative output voltage	16	GND	Ground
5	POK	Power OK	17	AUX	+5V/0.5A or +9V/0.3A Auxiliary power
6	GND	Ground	18	GND	Ground
7	PAR	Parallel operation current share	19	SCL	Serial Clock used in the I <sup>2</sup> C Interface
8	VSET	Aux output setting	20	SDA	Serial Data used in the I <sup>2</sup> C Interface
9	EN-	Inhibit ON/OFF (-)	21	AUX	+5V/0.5A or +9V/0.3A Auxiliary power
10	GND	Ground	22	GND	Ground
11	EN+	Inhibit ON/OFF (+)	23	RX	For RS232 Receiver function
12	AUX	+5V/0.5A or +9V/0.3A Auxiliary power	24	TX	For RS232 Transmission function

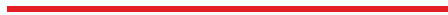

### LED STATUS INDICATOR

LED	LED Signal	Status
Solid (Green)		Power OK (Local mode)
Solid (Orange)		Power OK (Remote mode)
Slow Blink (Green)		Power Standby
Fast Blink (Red)		Over Voltage Protection (OVP)
Solid (Red)		Over Load Protection (OLP)
Slow Blink (Red)		Over Temperature Protection (OTP)
Intermittent Blink (Red)		Fan Failure
Interlace Blink (Red)		Power Failure

### REMOTE ON/OFF

(A) Default Setting

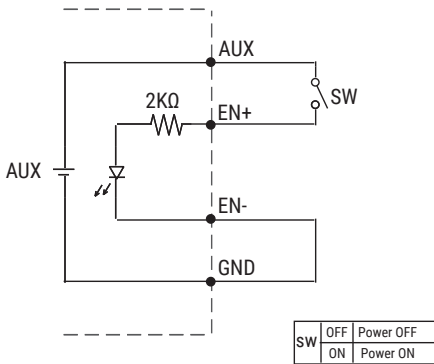

(A) Using internal 5V auxiliary source

(B)

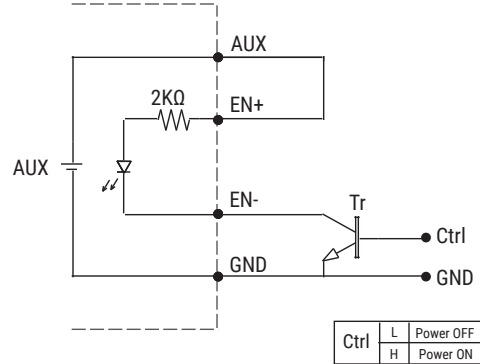

(B) ON / OFF Control by NPN transistor

(C)

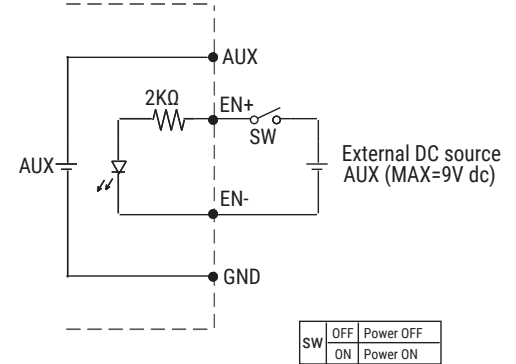

(C) Using external voltage source

\*GND shown in above diagram is referring to the GND of CN2, not the Grounding from main power(NEG-).\*

### DERATING CURVE

Load V.S Temp.

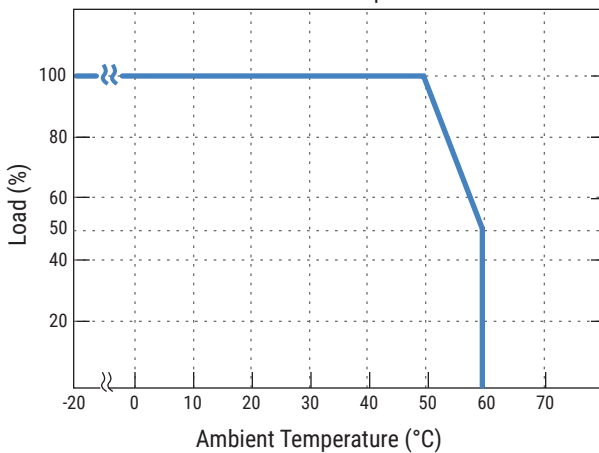

Load V.S I/P Voltage

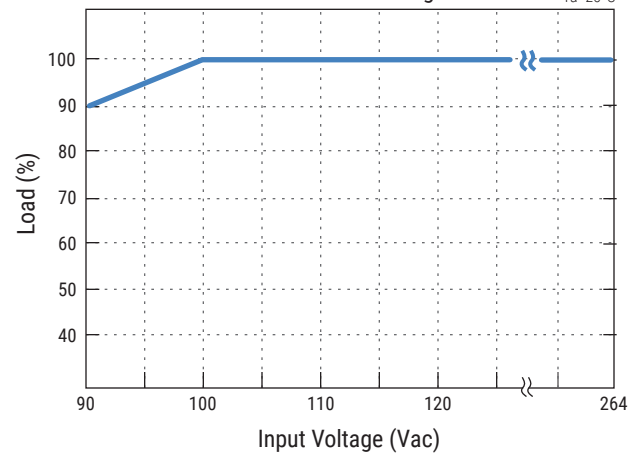



### CMD vs Output Curve

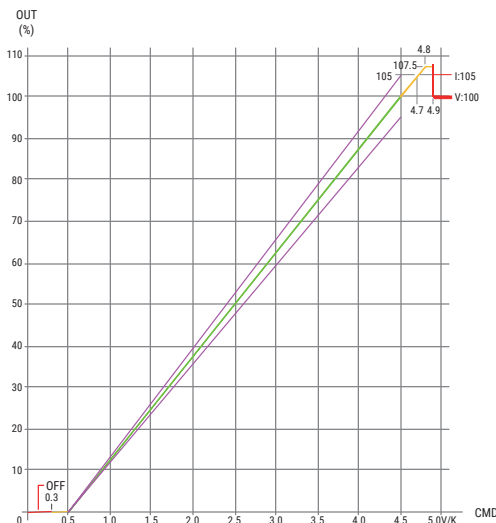

To ensure the power supply output voltage and current can be accurately adjusted, please make sure to adjust the output voltage and current > 10% vs. the rated voltage and current. (e.g. for a 24V unit, please adjust the DC output voltage above 2.4V to ensure accuracy; same applies to the output current)

### VCI vs OVP Curve

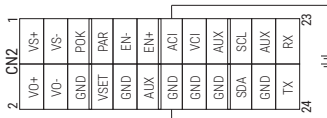
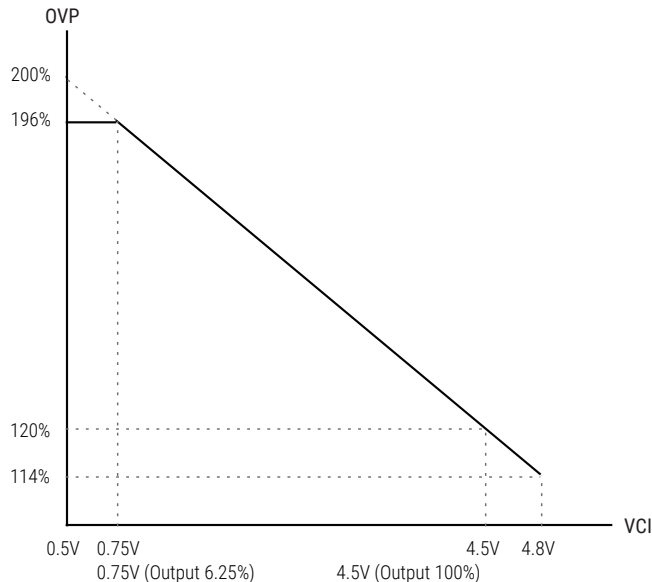

External Voltage (VDC)

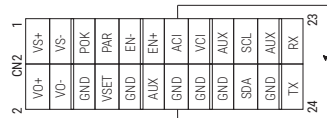

External Resistor (KΩ)

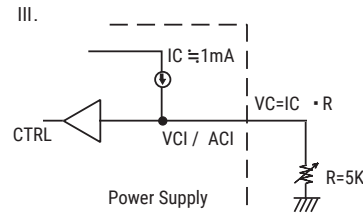
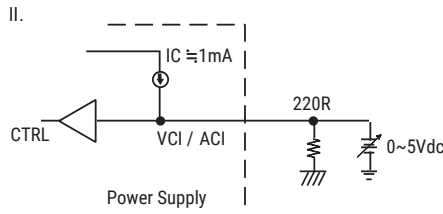
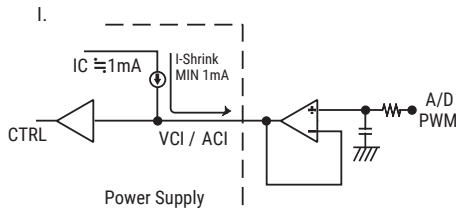

### Power OK Signal & Auxiliary Power Setting

\*The grounding of "AUX" power and P.OK signal should be connected to "GND" port. If "VO-" is connected as Grounding, make sure to short the GND and VO- ports.

Open drain signal low when PSU turns on. Max.  
P.OK sink current: 20mA, Max, drain voltage: 40V.

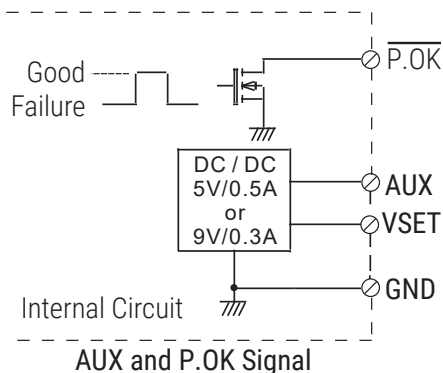

VSET	Open(Default Setting)	5V
	Short To GND	9V

\*Place an additional capacitor to have a better performance of auxiliary power operation.

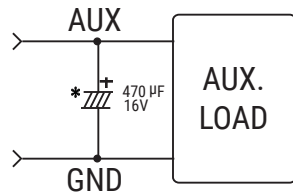

Do NOT exceed 5V/0.5A or 9V/0.3A

\*GND shown in above diagram is referring to the GND of CN2, not the Grounding from main power(NEG-)\*



## REMOTE SENSE

### Remote Sense

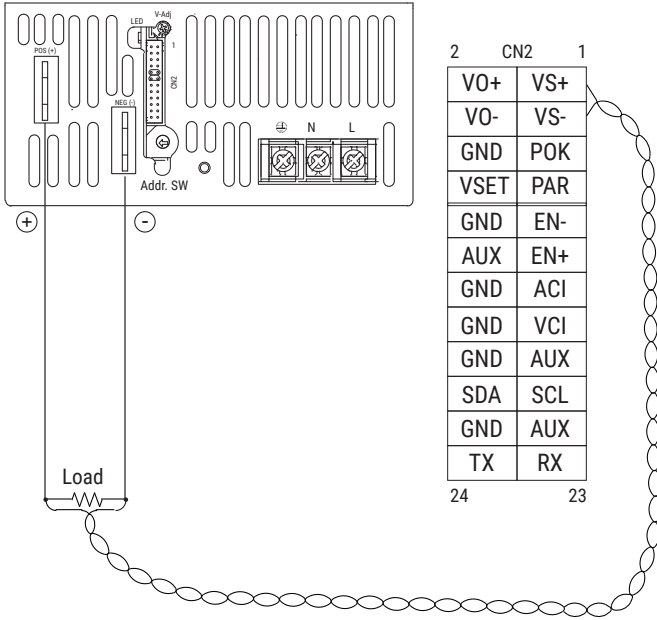

VS-, VS+ Compensation Voltage = <0.5V

### Local Sense (Default Setting)

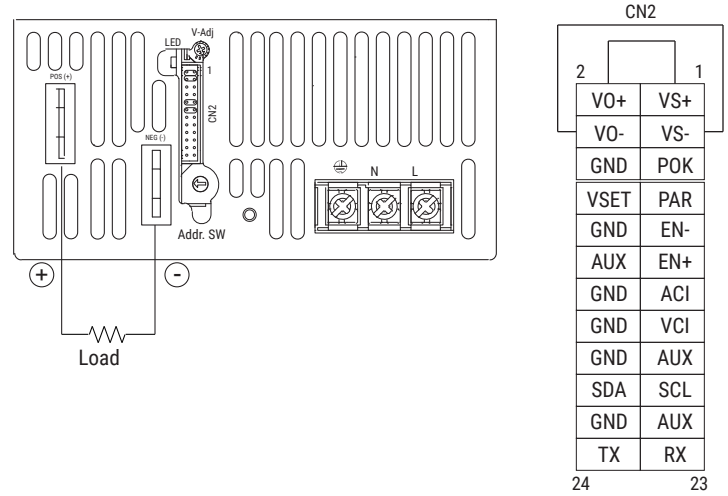

## Current Sharing

### Current Sharing with Remote Sensing (Parallel Connection)

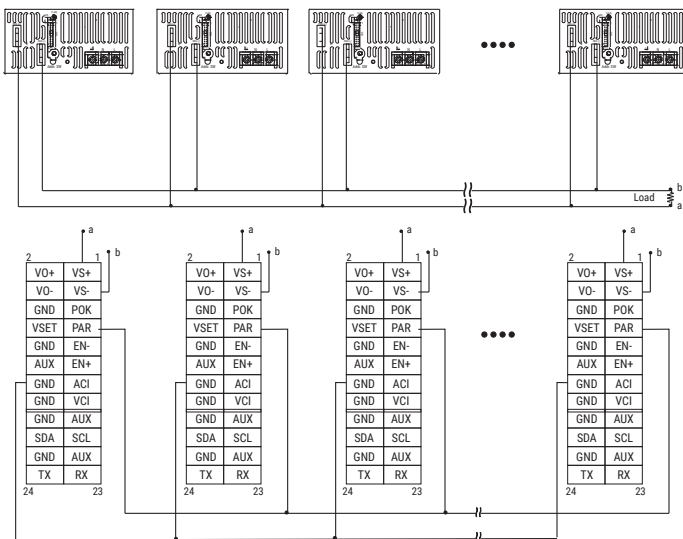

Connect PAR pins together for current sharing function.

### Current Sharing with Local Sensing

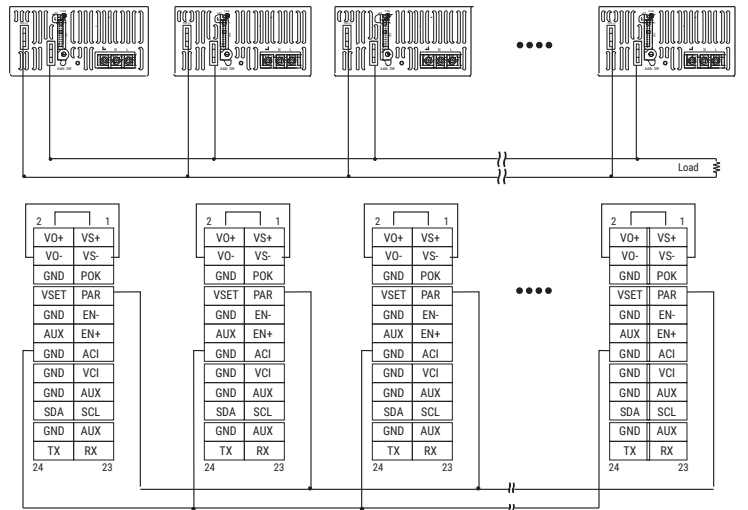

Connect PAR pins together for current sharing function.



## MOUNTING INSTRUCTIONS

Recommended standard mounting configurations:

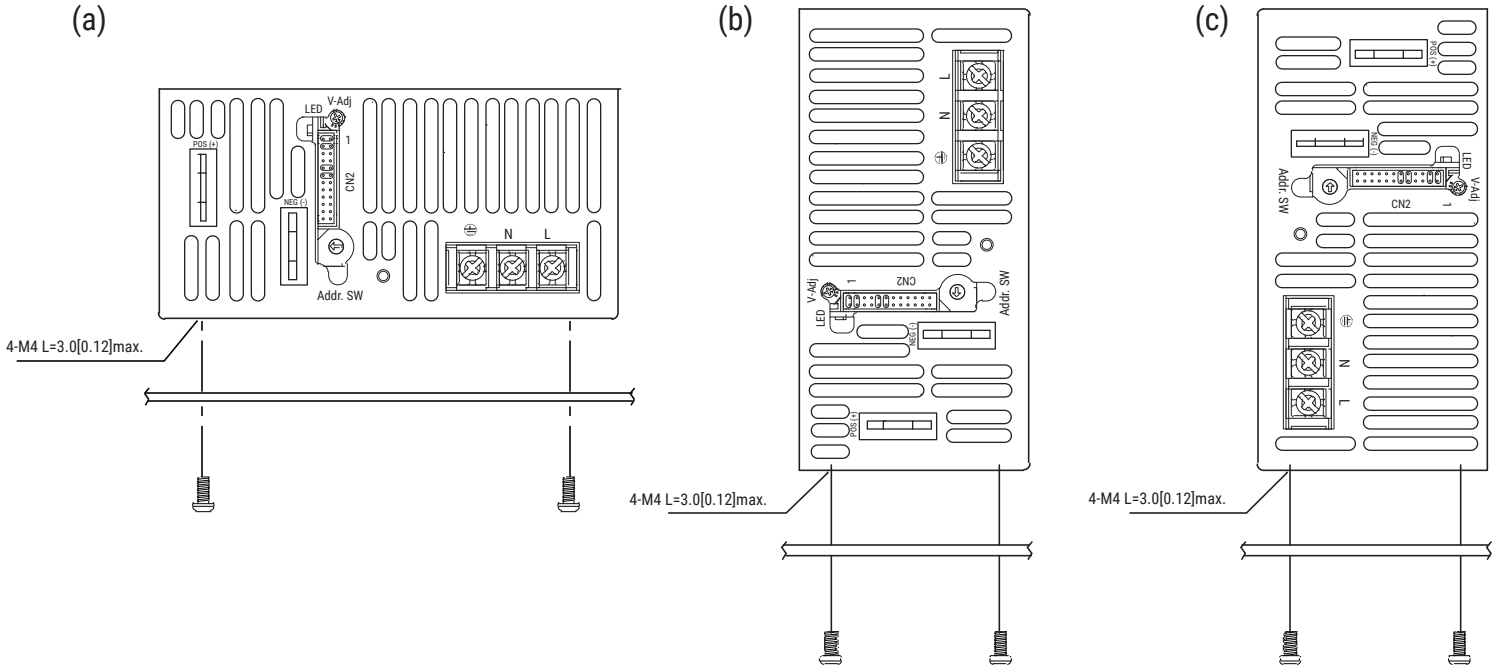

- Notes:
1. Recommended screw length is measured from the power supply surface.
  2. Ventilating holes on the front and back side panels should not be obstructed. Allow min. 50mm space for air flow. See below.
  3. Recommended torque of M4 mounting screws is  $1.27N \cdot m$  ( $13.0kgf \cdot cm$ )

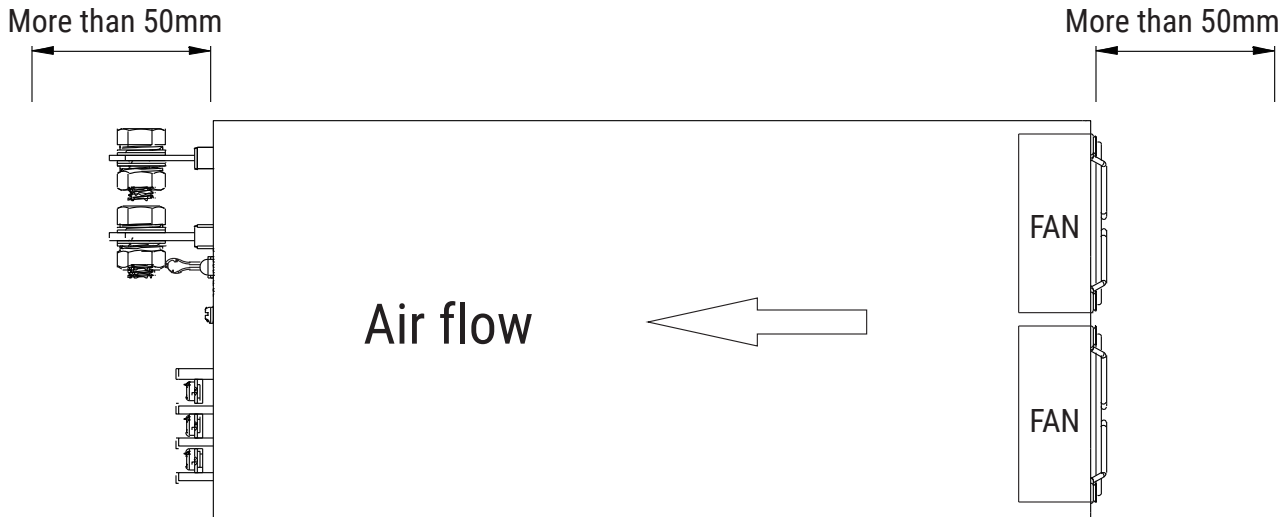



Компания «ЭлектроПласт» предлагает заключение долгосрочных отношений при поставках импортных электронных компонентов на взаимовыгодных условиях!

Наши преимущества:

- Оперативные поставки широкого спектра электронных компонентов отечественного и импортного производства напрямую от производителей и с крупнейших мировых складов;
- Поставка более 17-ти миллионов наименований электронных компонентов;
- Поставка сложных, дефицитных, либо снятых с производства позиций;
- Оперативные сроки поставки под заказ (от 5 рабочих дней);
- Экспресс доставка в любую точку России;
- Техническая поддержка проекта, помощь в подборе аналогов, поставка прототипов;
- Система менеджмента качества сертифицирована по Международному стандарту ISO 9001;
- Лицензия ФСБ на осуществление работ с использованием сведений, составляющих государственную тайну;
- Поставка специализированных компонентов (Xilinx, Altera, Analog Devices, Intersil, Interpoint, Microsemi, Aeroflex, Peregrine, Syfer, Eurofarad, Texas Instrument, Miteq, Cobham, E2V, MA-COM, Hittite, Mini-Circuits, General Dynamics и др.);

Помимо этого, одним из направлений компании «ЭлектроПласт» является направление «Источники питания». Мы предлагаем Вам помощь Конструкторского отдела:

- Подбор оптимального решения, техническое обоснование при выборе компонента;
- Подбор аналогов;
- Консультации по применению компонента;
- Поставка образцов и прототипов;
- Техническая поддержка проекта;
- Защита от снятия компонента с производства.



#### Как с нами связаться

**Телефон:** 8 (812) 309 58 32 (многоканальный)

**Факс:** 8 (812) 320-02-42

**Электронная почта:** [org@eplast1.ru](mailto:org@eplast1.ru)

**Адрес:** 198099, г. Санкт-Петербург, ул. Калинина, дом 2, корпус 4, литера А.