

DUAL OPERATIONAL AMPLIFIER

■ GENERAL DESCRIPTION

The NJM4558/4559 integrated circuit is a dual high-gain operational amplifier internally compensated and constructed on a single silicon chip using an advanced epitaxial process.

Combining the features of the NJM741 with the close parameter matching and tracking of a dual device on a monolithic chip results in unique performance characteristics. Excellent channel separation allows the use of the dual device in single NJM741 operational amplifier applications providing density. It is especially well suited for applications in differential-in, differential-out as well as in potentiometric amplifiers and where gain and phase matched channels are mandatory.

■ FEATURES

- Operating Voltage ($\pm 4V \sim \pm 18V$)
- High Voltage Gain (100dB typ.)
- High Input Resistance ($5M\Omega$ typ.)
- Bipolar Technology
- Package Outline
 DIP8, DMP8, SIP8
 SOP8 JEDEC 150mil (only NJM4558),
 SSOP8 (only NJM4558)

■ PACKAGE OUTLINE

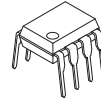

**NJM4558D
NJM4559D
(DIP8)**



**NJM4558M
NJM4559M
(DMP8)**



**NJM4558V
(SSOP8)**

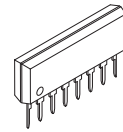

**NJM4558L
NJM4559L
(SIP8)**



**NJM4558E
(SOP8)**

■ PIN CONFIGURATION

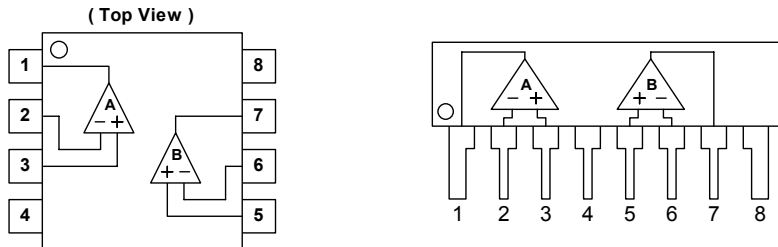

**NJM4558D, NJM4558M, NJM4558E, NJM4558V
NJM4559D, NJM4559M**

**NJM4558L
NJM4559L**

PIN FUNCTION

1. A OUTPUT
2. A - INPUT
3. A + INPUT
4. V^-
5. B + INPUT
6. B - INPUT
7. B OUTPUT
8. V^+

■ EQUIVALENT CIRCUIT (1/2 Shown)

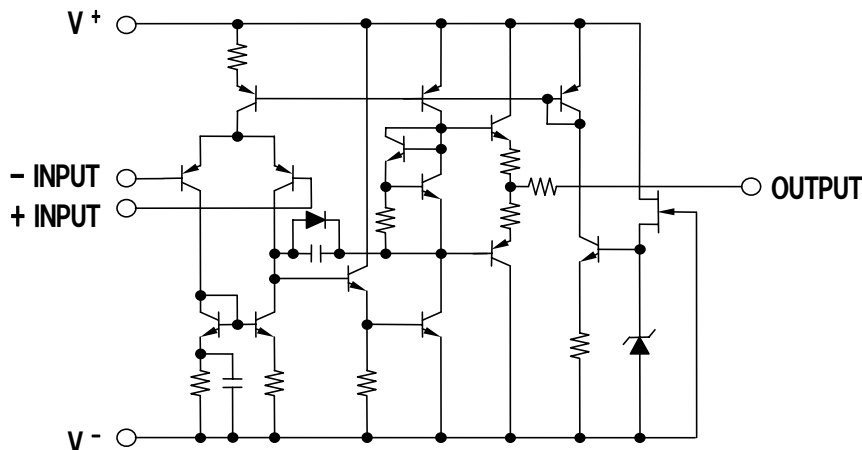

NJM4558/4559

■ ABSOLUTE MAXIMUM RATINGS

(Ta=25°C)

| PARAMETER | SYMBOL | RATINGS | UNIT |
|-----------------------------|-------------------|---|------|
| Supply Voltage | V ⁺ /V | ± 18 | V |
| Differential Input Voltage | V _{ID} | ± 30 | V |
| Input Voltage | V _{IC} | ± 15 (note1) | V |
| Power Dissipation | P _D | (DIP8) 500 (DMP8) 300 (SOP8) 300 (SSOP8) 250 (SIP8) 800 | mW |
| Operating Temperature Range | T _{opr} | -40~+85 | °C |
| Storage Temperature Range | T _{stg} | -40~+125 | °C |

(note1) For supply voltage less than ±15V, the absolute maximum input voltage is equal to the supply voltage.

■ ELECTRICAL CHARACTERISTICS

(V⁺/V=±15V, Ta=25°C)

| PARAMETER | SYMBOL | TEST CONDITION | MIN. | TYP. | MAX. | UNIT |
|--|------------------|---|------|------|------|-------|
| Input Offset Voltage | V _{IO} | R _S ≤10kΩ | - | 0.5 | 6 | mV |
| Input Offset Current | I _{IO} | | - | 5 | 200 | nA |
| Input Bias Current | I _B | | - | 25 | 500 | nA |
| Input Resistance | R _{IN} | | 0.3 | 5 | - | MΩ |
| Large Signal Voltage Gain | A _V | R _L ≥2kΩ, V _O =±10V | 86 | 100 | - | dB |
| Maximum Output Voltage Swing 1 | V _{OM1} | R _L ≥10kΩ | ± 12 | ± 14 | - | V |
| Maximum Output Voltage Swing 2 | V _{OM2} | R _L ≥2kΩ | ± 10 | ± 13 | - | V |
| Input Common Mode Voltage Range | V _{ICM} | | ± 12 | 14 | - | V |
| Common Mode Rejection Ratio | CMR | R _S ≤10kΩ | 70 | 90 | - | dB |
| Supply Voltage Rejection Ratio | SVR | R _S ≤10kΩ | 76.5 | 90 | - | dB |
| Operating Current | I _{CC} | | - | 3.5 | 5.7 | mA |
| Slew Rate | | | | | | |
| NJM4558 | SR | | - | 1 | - | V/μs |
| NJM4559 | SR | | - | 2 | - | V/μs |
| Equivalent Input Noise Voltage (note2) | V _{NI} | RIAA, R _S =2.2kΩ, 30kHz LPF | - | 1.4 | - | μVrms |
| Gain Bandwidth Product | GB | | | | | |
| NJM4558 | | | | 3 | | MHz |
| NJM4559 | | | | 6 | | MHz |

(note2) In regard to Noise Standard, NJRC is preparing for special D Rank type products (V_{NI}=1.8μV max.) except for SSOP package.

■ TYPICAL CHARACTERISTICS

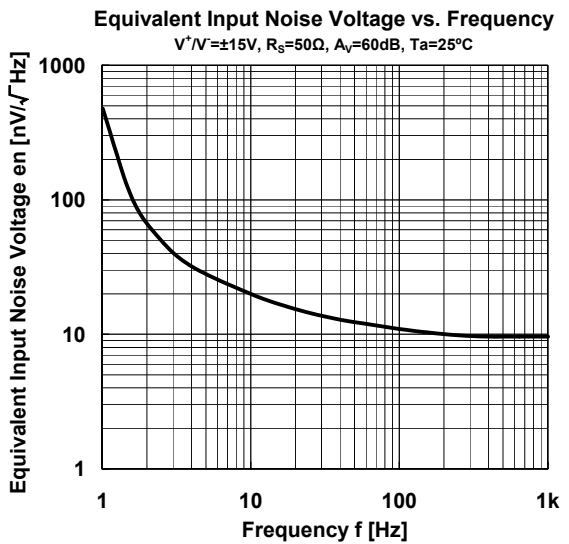
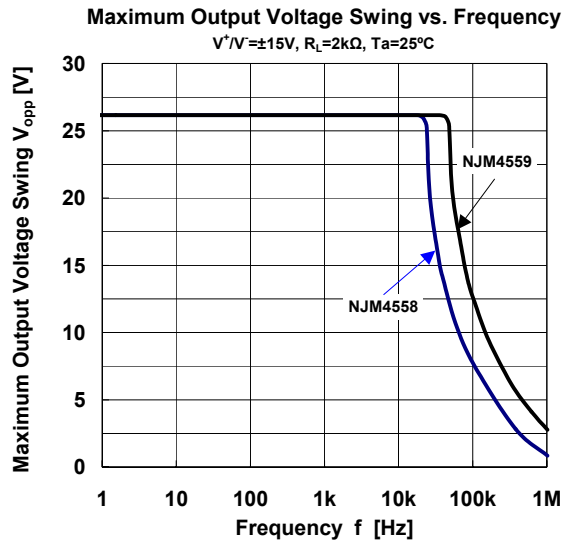

NJM4558/4559

■ TYPICAL CHARACTERISTICS

Input Offset Voltage vs. temperature
 $V^+ / V^- = \pm 15V$

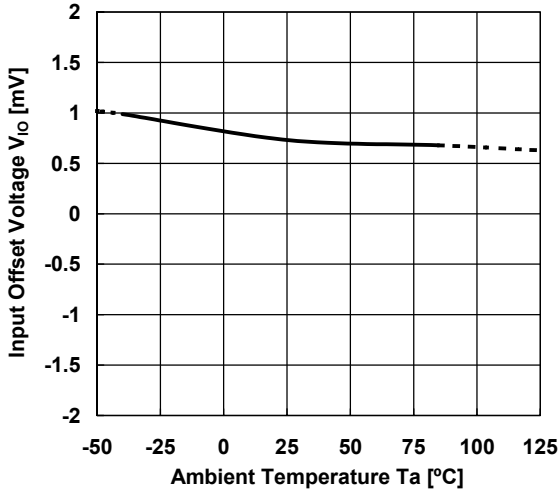

Input Bias Current vs. Temperature
 $V^+ / V^- = \pm 15V$

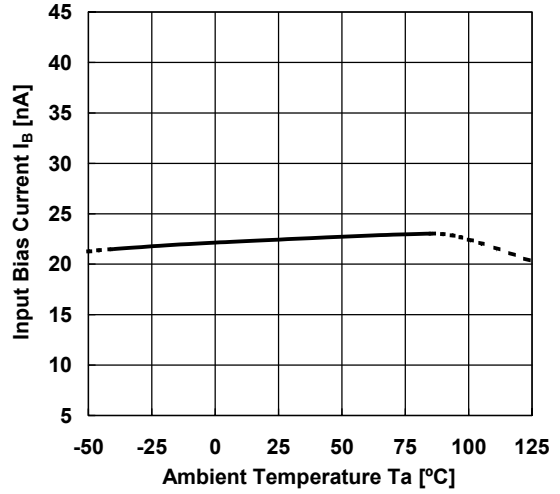

Maximum Output Voltage Swing vs. Operating Voltage
 $R_L = 2k\Omega, T_a = 25^\circ C$

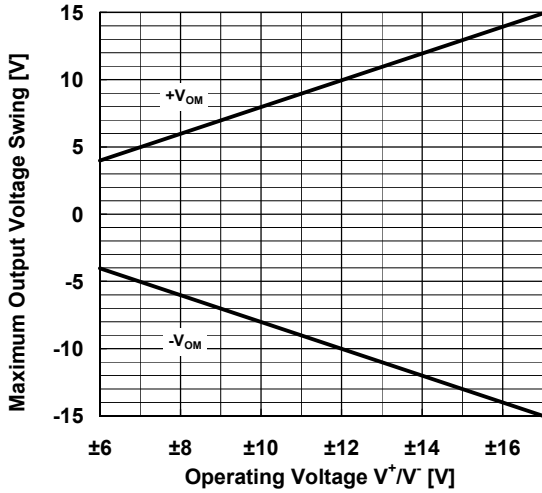

Operating Current vs. Operating Voltage
 $T_a = 25^\circ C$

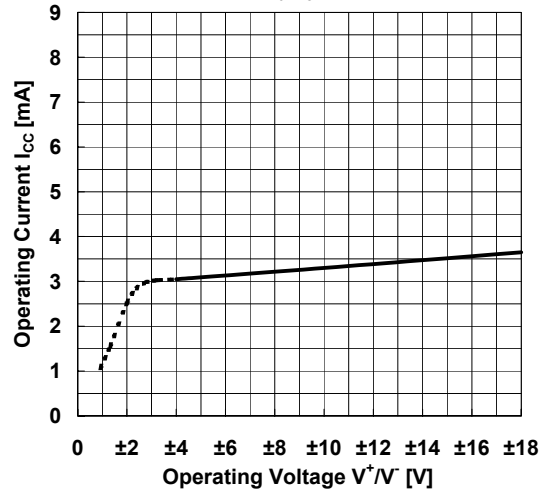

[CAUTION]
 The specifications on this databook are only given for information, without any guarantee as regards either mistakes or omissions. The application circuits in this databook are described only to show representative usages of the product and not intended for the guarantee or permission of any right including the industrial rights.

Mouser Electronics

Authorized Distributor

Click to View Pricing, Inventory, Delivery & Lifecycle Information:

[NJR:](#)

[NJM4559M-TE1](#) [NJM4559M-TE2](#) [NJM4558D](#) [NJM4558L](#) [NJM4558M](#) [NJM4558V-TE2](#) [NJM4558MD-TE3](#)
[NJM4558MD-TE1](#) [NJM4558MD-TE2](#) [NJM4558MD](#) [NJM4558DX](#) [NJM4558E-TE2](#) [NJM4558LD](#) [NJM4558DD](#)
[NJM4558E-TE1](#) [NJM4558M-TE1](#) [NJM4558M-TE3](#) [NJM4558M-TE2](#) [NJM4559L](#) [NJM4559E](#) [NJM4559M](#) [NJM4559D](#)
[NJM4558V-TE1](#) [NJM4559DD](#)



Компания «ЭлектроПласт» предлагает заключение долгосрочных отношений при поставках импортных электронных компонентов на взаимовыгодных условиях!

Наши преимущества:

- Оперативные поставки широкого спектра электронных компонентов отечественного и импортного производства напрямую от производителей и с крупнейших мировых складов;
- Поставка более 17-ти миллионов наименований электронных компонентов;
- Поставка сложных, дефицитных, либо снятых с производства позиций;
- Оперативные сроки поставки под заказ (от 5 рабочих дней);
- Экспресс доставка в любую точку России;
- Техническая поддержка проекта, помощь в подборе аналогов, поставка прототипов;
- Система менеджмента качества сертифицирована по Международному стандарту ISO 9001;
- Лицензия ФСБ на осуществление работ с использованием сведений, составляющих государственную тайну;
- Поставка специализированных компонентов (Xilinx, Altera, Analog Devices, Intersil, Interpoint, Microsemi, Aeroflex, Peregrine, Syfer, Eurofarad, Texas Instrument, Miteq, Cobham, E2V, MA-COM, Hittite, Mini-Circuits, General Dynamics и др.);

Помимо этого, одним из направлений компании «ЭлектроПласт» является направление «Источники питания». Мы предлагаем Вам помощь Конструкторского отдела:

- Подбор оптимального решения, техническое обоснование при выборе компонента;
- Подбор аналогов;
- Консультации по применению компонента;
- Поставка образцов и прототипов;
- Техническая поддержка проекта;
- Защита от снятия компонента с производства.



Как с нами связаться

Телефон: 8 (812) 309 58 32 (многоканальный)

Факс: 8 (812) 320-02-42

Электронная почта: org@eplast1.ru

Адрес: 198099, г. Санкт-Петербург, ул. Калинина, дом 2, корпус 4, литера А.