

1.8V 125MHz 3rd Over Tone Quartz Crystal Oscillator

■GENERAL DESCRIPTION

The NJU6394 series is a C-MOS, 1.8V, 125MHz, 3rd overtone quartz crystal oscillator that consists of an oscillation amplifier (low oscillation-stop current based on NAND circuit) and 3-state output buffer (C-MOS compatible, 15pF load).

The operating voltage is from 1.6V to 3.0V, and frequency range is from 75MHz to 125MHz divided by 3 version, A-type: 75MHz to 90MHz, B-type: 90MHz to 105MHz, C-type: 105MHz to 125MHz.

The oscillation amplifier realizes very low oscillation stop current with NAND circuit.

The 3-state output buffer is C-MOS compatible.

■PACKAGE OUTLINE



NJU6394XC-X

■FEATURES

- Operating Voltage 1.6 to 3.0V
- Maximum Oscillation Frequency (See Line-up Table)
- Oscillation Stop and Output Stand-by Function
- 3-State Output Buffer
- Oscillation Capacitors C_g and C_d on-Die
- Package Outline Thin-Die/Wafer
- C-MOS Technology

■PAD LOCATION

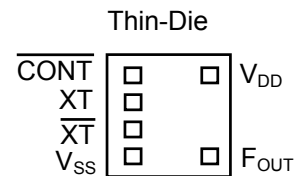

■LINE-UP TABLE

Type No.	Recommended Oscillation Frequency	Output Frequency	R _f	C _g /C _d
NJU6394	A 75 to 90MHz	f ₀	2.2 kΩ	8/12pF
	B 90 to 105MHz			7/10pF
	C 105 to 125MHz			6/7pF

■COORDINATES

No	Pad Name	X	Y
1	CONT	-178	231
2	XT	-178	77
3	XT	-178	-77
4	V _{SS}	-178	-231
5	F _{OUT}	206	-231
6	V _{DD}	206	231

Starting Point: Die Center Unit[μm]

Die Size: 0.7x0.75mm

Thin-Die Thickness(C-D): 200±20μm

Thin-Die Thickness(C-L): 140±10μm

Wafer Thickness(W-H): 200±20μm

Wafer Thickness(W-L): 140±10μm

Pad Size: 90x90μm

Die Substrate: V_{DD} Level

■BLOCK DIAGRAM

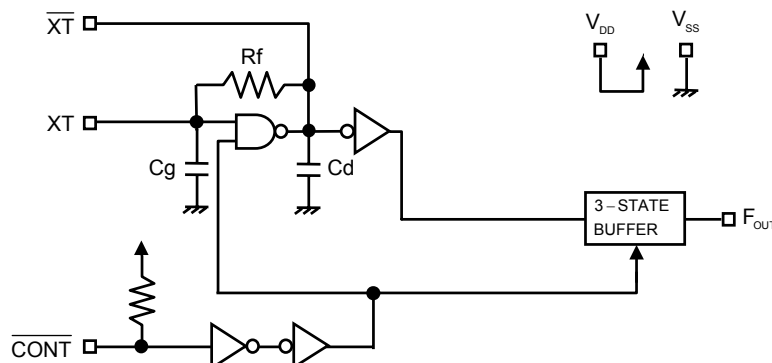

■ TERMINAL DESCRIPTION

SYMBOL	FUNCTION	
$\overline{\text{CONT}}$	Oscillation and 3-state Output Buffer Control	
	$\overline{\text{CONT}}$	F_{OUT}
	H or OPEN	Output frequency f_0
	L	Oscillation Stop and High impedance Output
$\overline{\text{XT}}$	Quartz Crystal Connecting Terminals	
$\overline{\text{XT}}$		
V_{SS}	$V_{\text{SS}}=0\text{V}$	
F_{OUT}	Frequency Output	
V_{DD}	$V_{\text{DD}}=1.8\text{V}$	

■ ABSOLUTE MAXIMUM RATINGS

($T_a=25^\circ\text{C}$)

PARAMETER	SYMBOL	RATING	UNIT
Supply Voltage	V_{DD}	-0.5 to +7.0	V
Input Voltage	V_{IN}	$V_{\text{SS}}-0.5$ to $V_{\text{DD}}+0.5$	V
Output Voltage	V_{O}	-0.5 to $V_{\text{DD}}+0.5$	V
Input Current	I_{IN}	± 10	mA
Output Current	I_{O}	± 25	mA
Operating Temperature Range	T_{opr}	-40 to +85	$^\circ\text{C}$
Storage Temperature Range	T_{stg}	-55 to +125	$^\circ\text{C}$

Note1) If the supply voltage(V_{DD}) is less than 7.0V, the input voltage must not over the V_{DD} level though 7.0V is limit specified.

Note2) Decoupling capacitor should be connected between V_{DD} and V_{SS} due to the stabilized operation for the circuit.

■ELECTRICAL CHARACTERISTICS

(Ta=25°C)

PARAMETER	SYMBOL	CONDITIONS	MIN	TYP	MAX	UNIT
Operating Voltage	V _{DD}		1.6		3.0	V

(V_{DD}=1.8V, Ta=25°C)

PARAMETER	SYMBOL	CONDITIONS	MIN	TYP	MAX	UNIT
Operating Current	I _{DD1}	A type, fosc=90MHz, C _L =15pF		6	10	mA
		B type, fosc=105MHz, C _L =15pF		7	12	
		C type, fosc=125MHz, C _L =15pF		8	12	
Oscillation Stopping Current	I _{DD2}	CONT=V _{SS} , No load		2	6	uA
Stand-by Current	I _{st}	CONT=XT=V _{SS} , No load Note3)			2	uA
Input Voltage	V _{IH}		1.26		1.8	V
	V _{IL}		0		0.54	V
Output Current	I _{OH}	V _{OH} =1.62V	2			mA
	I _{OL}	V _{OL} =0.18V	2			mA
Input Current	I _{IN}	CONT=0.8V _{DD}		3.0	4.5	uA
		CONT=0.2V _{DD}		0.5	0.7	uA
3-state Off Leakage Current	I _{oZ}	CONT=V _{SS} , F _{OUT} = V _{DD} or V _{SS}			±0.2	uA
Feedback Resistance	R _f	A type		2.2		kΩ
Internal Capacitor	C _g /C _d	A type, fosc=90MHz		8/12		pF
		B type, fosc=105MHz		7/10		
		C type, fosc=125MHz		6/7		
Maximum Oscillation Frequency	F _{MAX}	A type	90			MHz
		B type	105			
		C type	125			
Output Signal Symmetry	SYM	C _L =15pF, @V _{DD} /2	45	50	55	%
Output Signal Rise Time	t _r	C _L =15pF, 10% to 90%		2.2	3	ns
Output Signal Fall Time	t _f	C _L =15pF, 90% to 10%		2.2	3	ns
Output Disable time	t _{PLZ}	C _L =15pF, R _{UP} =10kΩ			250	ns
Output Enable Time	t _{PZL}	C _L =15pF, R _{UP} =10kΩ			250	ns

Note3) Excluding input current on CONT Terminal.

■STANDARD CRYSTAL PARAMETERS FOR MEASUREMENT CIRCUITS

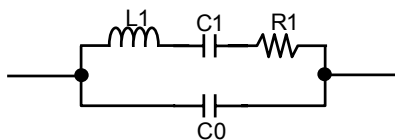

f[MHz]	R1[Ω]	L1[mH]	C1[fF]	C0[pF]
90	27.6	3.12	1.00	3.29
105	17.1	1.99	1.16	3.27
125	14.9	1.20	1.36	4.83

MEASUREMENT CIRCUITS

(1) Output Signal Symmetry ($C_L=15\text{pF}$)

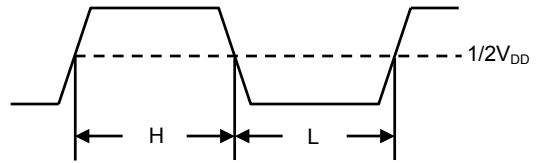
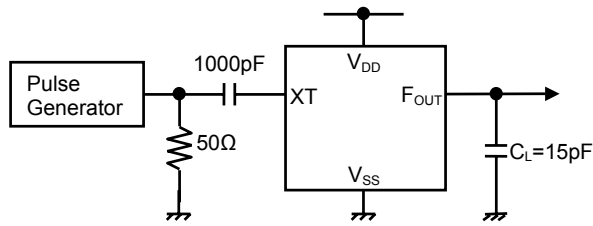

(2) Output Signal Rise/Fall Time ($C_L=15\text{pF}$)

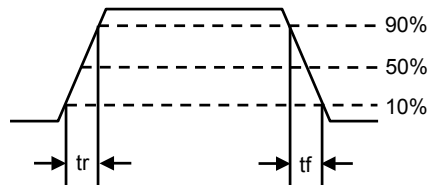
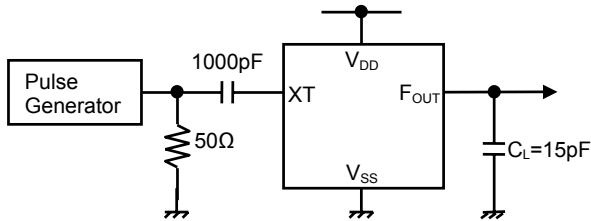

(3) Output Disable/Enable Time ($C_L=15\text{pF}, R_{UP}=10\text{k}\Omega$)

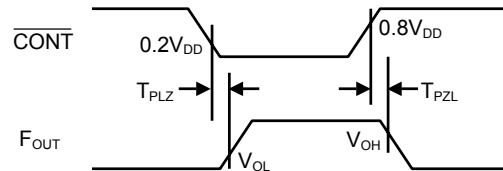
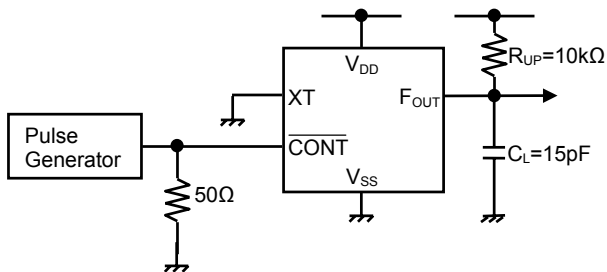

[CAUTION]
 The specifications on this data book are only given for information, without any guarantee as regards either mistakes or omissions. The application circuits in this data book are described only to show representative usages of the product and not intended for the guarantee or permission of any right including the industrial rights.

Mouser Electronics

Authorized Distributor

Click to View Pricing, Inventory, Delivery & Lifecycle Information:

[NJR:](#)

[NJU6394AC-L](#) [NJU6394CC-D](#) [NJU6394CC-L](#) [NJU6394AC-D](#) [NJU6394BC-D](#) [NJU6394BC-L](#)



Компания «ЭлектроПласт» предлагает заключение долгосрочных отношений при поставках импортных электронных компонентов на взаимовыгодных условиях!

Наши преимущества:

- Оперативные поставки широкого спектра электронных компонентов отечественного и импортного производства напрямую от производителей и с крупнейших мировых складов;
- Поставка более 17-ти миллионов наименований электронных компонентов;
- Поставка сложных, дефицитных, либо снятых с производства позиций;
- Оперативные сроки поставки под заказ (от 5 рабочих дней);
- Экспресс доставка в любую точку России;
- Техническая поддержка проекта, помощь в подборе аналогов, поставка прототипов;
- Система менеджмента качества сертифицирована по Международному стандарту ISO 9001;
- Лицензия ФСБ на осуществление работ с использованием сведений, составляющих государственную тайну;
- Поставка специализированных компонентов (Xilinx, Altera, Analog Devices, Intersil, Interpoint, Microsemi, Aeroflex, Peregrine, Syfer, Eurofarad, Texas Instrument, Miteq, Cobham, E2V, MA-COM, Hittite, Mini-Circuits, General Dynamics и др.);

Помимо этого, одним из направлений компании «ЭлектроПласт» является направление «Источники питания». Мы предлагаем Вам помощь Конструкторского отдела:

- Подбор оптимального решения, техническое обоснование при выборе компонента;
- Подбор аналогов;
- Консультации по применению компонента;
- Поставка образцов и прототипов;
- Техническая поддержка проекта;
- Защита от снятия компонента с производства.



Как с нами связаться

Телефон: 8 (812) 309 58 32 (многоканальный)

Факс: 8 (812) 320-02-42

Электронная почта: org@eplast1.ru

Адрес: 198099, г. Санкт-Петербург, ул. Калинина, дом 2, корпус 4, литера А.