



MCP3905A/05L/06A

Energy Metering ICs with Active Real Power Pulse Output

Features

- Supplies active (real) power measurement for single-phase, residential energy metering
- Supports IEC 62053 International Energy Metering Specification and legacy IEC 1036/61036/687 Specifications
- Two multi-bit, DAC, second-order, 16-bit, Delta-Sigma Analog-to-Digital Converters (ADCs)
- Reduced pulse-width of calibration output frequency and mechanical counter drive for low power meter designs (**MCP3905L**)
- Increased output frequency constant options for meter design (**MCP3905L**)
- 0.1% typical measurement error over **500:1** dynamic range (**MCP3905A / MCP3905L**)
- 0.1% typical measurement error over **1000:1** dynamic range (**MCP3906A**)
- Programmable Gain Amplifier (PGA) for small signal inputs supports low value shunt current sensor:
 - **16:1** PGA - MCP3905A / MCP3905L
 - **32:1** PGA - MCP3906A
- Ultra-low drift on-chip reference: 15 ppm/°C (typical)
- Direct drive for electromagnetic mechanical counter and two-phase stepper motors
- Low I_{DD} of 4 mA (typical)
- Tamper output pin for negative power indication
- Industrial Temperature Range: -40°C to +85°C
- Extended Temperature Range: -40°C to +125°C
- Supplies instantaneous real power on HF_{OUT} for meter calibration

Description

The MCP3905A/05L/06A devices are energy-metering ICs designed to support the IEC 62053 international metering standard specification. They supply a frequency output proportional to the average active real power, as well as a higher-frequency output proportional to the instantaneous power for meter calibration. The MCP3905L offers reduced pulse width of calibration output frequency and mechanical counter drive for lower power meter designs. They include two 16-bit, Delta-Sigma ADCs for a wide range of I_B and I_{MAX} currents and/or small shunt (<200 μOhms) meter designs. It includes an ultra-low drift voltage reference with < 15 ppm/°C through a specially designed band gap temperature curve for the minimum gradient across the industrial temperature range. A fixed-function DSP block is on-chip for active real-power calculation. A no-load threshold block prevents any current creep measurements. A Power-On Reset (POR) block restricts meter performance during low-voltage situations. These accurate energy metering ICs with high field reliability are available in the industry standard pinout.

Package Type

24-Pin SSOP			
DV _{DD}	1	24	F _{OUT0}
HPF	2	23	F _{OUT1}
AV _{DD}	3	22	HF _{OUT}
NC	4	21	D _{GND}
CH0+	5	20	NEG
CH0-	6	19	NC
CH1-	7	18	OSC2
CH1+	8	17	OSC1
MCLR	9	16	G0
REFIN/OUT	10	15	G1
A _{GND}	11	14	F0
F2	12	13	F1

Functional Block Diagram

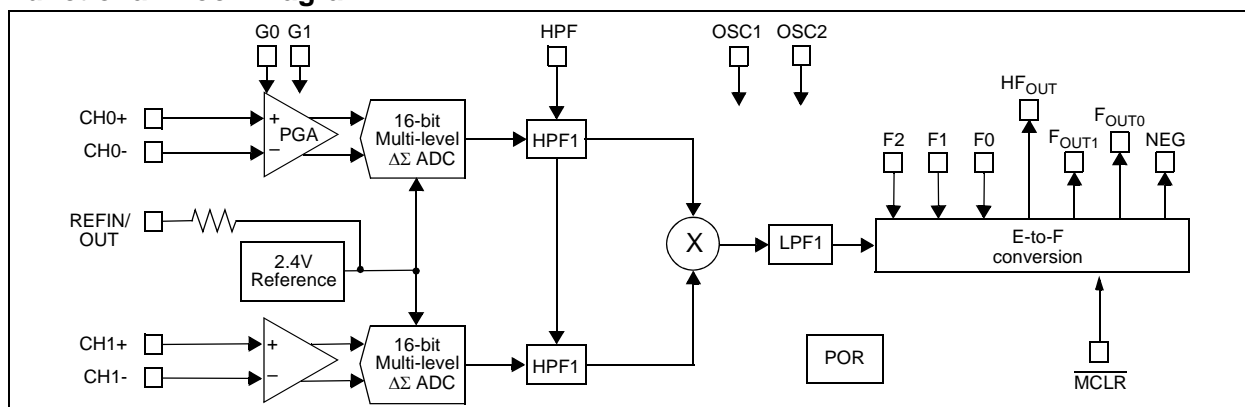

MCP3905A/05L/06A

NOTES:

1.0 ELECTRICAL CHARACTERISTICS

Absolute Maximum Ratings †

V_{DD}	7.0V
Digital inputs and outputs w.r.t. A_{GND}	-0.6V to $V_{DD} + 0.6V$
Analog input w.r.t. A_{GND}	-6V to +6V
V_{REF} input w.r.t. A_{GND}	-0.6V to $V_{DD} + 0.6V$
Storage temperature	-65°C to +150°C
Ambient temp. with power applied.....	-65°C to +125°C
Soldering temperature of leads (10 seconds)	+300°C
ESD on the analog inputs (HBM,MM).....	5.0 kV, 500V
ESD on all other pins (HBM,MM).....	5.0 kV, 500V

† **Notice:** Stresses above those listed under “Maximum Ratings” may cause permanent damage to the device. This is a stress rating only and functional operation of the device at those or any other conditions above those indicated in the operation listings of this specification is not implied. Exposure to maximum rating conditions for extended periods may affect device reliability.

ELECTRICAL CHARACTERISTICS

Electrical Specifications: Unless otherwise indicated, all parameters apply at $AV_{DD} = DV_{DD} = 4.5V - 5.5V$, Internal V_{REF} , HPF turned on (AC mode), $A_{GND}, D_{GND} = 0V$, $MCLK = 3.58 MHz$; $T_A = -40°C$ to $+85°C$.

Parameter	Sym	Min	Typ	Max	Units	Comment
Overall Measurement Accuracy						
Energy Measurement Error	E	—	0.1	—	% F_{OUT}	Channel 0 swings 1:500 range, MCP3905A, MCP3905L only (Note 1, Note 4)
		—	0.1	—	% F_{OUT}	Channel 0 swings 1:1000 range, MCP3906A only (Note 1, Note 4)
No-Load Threshold/ Minimum Load	NLT	—	0.0015	—	% F_{OUT} Max	Disabled when F2, F1, F0 = 0, 1, 1 (Note 5, Note 6)
Phase Delay Between Channels		—	—	1/MCLK	s	HPF = 0 and 1, < 1 MCLK (Note 4, Note 6, Note 7)
AC Power Supply Rejection (output frequency variation)	AC PSRR	—	0.01	—	% F_{OUT}	F2, F1, F0 = 0, 1, 1 (Note 3)
DC Power Supply Rejection (output frequency variation)	DC PSRR	—	0.01	—	% F_{OUT}	HPF = 1, Gain = 1 (Note 3)
System Gain Error		—	3	10	% F_{OUT}	(Note 2, Note 5)
ADC/PGA Specifications						
Offset Error	V_{OS}	—	2	5	mV	Referred to Input
Gain Error Match		—	0.5	—	% F_{OUT}	(Note 5)
Internal Voltage Reference						
Voltage		—	2.4	—	V	
Tolerance		—	±2	—	%	
Tempco		—	15	—	ppm/°C	

- Note 1:** Measurement error = (Energy Measured By Device - True Energy)/True Energy * 100%. Accuracy is measured with signal (±660 mV) on Channel 1. F_{OUT0}, F_{OUT1} pulse outputs. Valid from 45 Hz to 65 Hz. See typical performance curves for higher frequencies and increased dynamic range.
- 2:** Does not include internal V_{REF} . Gain = 1, CH0 = 470 mVDC, CH1 = 660 mVDC, difference between measured output frequency and expected transfer function.
- 3:** Percent of HF_{OUT} output frequency variation; Includes external $V_{REF} = 2.5V$, CH1 = 100 mVRMS @ 50 Hz, CH2 = 100 mVRMS @ 50 Hz, $AV_{DD} = 5V + 1V_{pp}$ @ 100 Hz. DC PSRR: 5V ±500 mV
- 4:** Error applies down to 60 degree lead (PF = 0.5 capacitive) and 60 degree lag (PF = 0.5 inductive).
- 5:** Refer to **Section 4.0 “Device Overview”** for complete description.
- 6:** Specified by characterization, not production tested.
- 7:** 1 MCLK period at 3.58 MHz is equivalent to less than <0.005 degrees at 50 or 60 Hz.

MCP3905A/05L/06A

ELECTRICAL CHARACTERISTICS (CONTINUED)

Electrical Specifications: Unless otherwise indicated, all parameters apply at $V_{DD} = DV_{DD} = 4.5V - 5.5V$, Internal V_{REF} , HPF turned on (AC mode), $A_{GND}, D_{GND} = 0V$, $MCLK = 3.58\text{ MHz}$; $T_A = -40^\circ\text{C}$ to $+85^\circ\text{C}$.						
Parameter	Sym	Min	Typ	Max	Units	Comment
Reference Input						
Input Range		2.2	—	2.6	V	
Input Impedance		3.2	—	—	k Ω	
Input Capacitance		—	—	10	pF	
Analog Inputs						
Maximum Signal Level		—	—	± 1	V	CH0+,CH0-,CH1+,CH1- to A_{GND}
Differential Input Voltage Range Channel 0		—	—	$\pm 470/G$	mV	G = PGA Gain on Channel 0
Differential Input Voltage Range Channel 1		—	—	± 660	mV	
Input Impedance		390	—	—	k Ω	Proportional to $1/MCLK$ frequency
Bandwidth (Notch Frequency)		—	14	—	kHz	Proportional to $MCLK$ frequency, $MCLK/256$
Oscillator Input						
Frequency Range	MCLK	1	—	4	MHz	
Power Specifications						
Operating Voltage		4.5	—	5.5	V	V_{DD}, DV_{DD}
$I_{DD,A}$	$I_{DD,A}$	—	2.7	3.0	mA	V_{DD} pin only
$I_{DD,D}$	$I_{DD,D}$	—	1.2	2.0	mA	DV_{DD} pin only

- Note 1:** Measurement error = (Energy Measured By Device - True Energy)/True Energy * 100%. Accuracy is measured with signal ($\pm 660\text{ mV}$) on Channel 1. F_{OUT0}, F_{OUT1} pulse outputs. Valid from 45 Hz to 65 Hz. See typical performance curves for higher frequencies and increased dynamic range.
- 2:** Does not include internal V_{REF} . Gain = 1, CH0 = 470 mVDC, CH1 = 660 mVDC, difference between measured output frequency and expected transfer function.
- 3:** Percent of HF_{OUT} output frequency variation; Includes external $V_{REF} = 2.5V$, CH1 = 100 mVRMS @ 50 Hz, CH2 = 100 mVRMS @ 50 Hz, $V_{DD} = 5V + 1V_{pp}$ @ 100 Hz. DC PSRR: $5V \pm 500\text{ mV}$
- 4:** Error applies down to 60 degree lead (PF = 0.5 capacitive) and 60 degree lag (PF = 0.5 inductive).
- 5:** Refer to [Section 4.0 "Device Overview"](#) for complete description.
- 6:** Specified by characterization, not production tested.
- 7:** 1 MCLK period at 3.58 MHz is equivalent to less than <0.005 degrees at 50 or 60 Hz.

TEMPERATURE CHARACTERISTICS

Electrical Specifications: Unless otherwise indicated, $V_{DD} = 4.5V - 5.5V$, $A_{GND}, D_{GND} = 0V$.						
Parameters	Sym	Min	Typ	Max	Units	Conditions
Temperature Ranges						
Specified Temperature Range	T_A	-40	—	+85	$^\circ\text{C}$	
Operating Temperature Range	T_A	-40	—	+125	$^\circ\text{C}$	(Note)
Storage Temperature Range	T_A	-65	—	+150	$^\circ\text{C}$	

Note: The MCP3905A/05L/06A operate over this extended temperature range, but with reduced performance. In any case, the Junction Temperature (T_J) must not exceed the Absolute Maximum specification of $+150^\circ\text{C}$.

MCP3905A/05L/06A

TIMING CHARACTERISTICS

Electrical Specifications: Unless otherwise indicated, all parameters apply at $V_{DD} = DV_{DD} = 4.5V - 5.5V$, $A_{GND}, D_{GND} = 0V$, $MCLK = 3.58 MHz$; $T_A = -40^{\circ}C$ to $+85^{\circ}C$.

Parameter	Sym	Min	Typ	Max	Units	Comment
Frequency Output						
F_{OUT0} and F_{OUT1} Pulse Width (Logic Low) for MCP3905A, MCP3906A devices	t_{FW}	—	275	—	ms	984376 MCLK periods (Note 1)
HF_{OUT} Pulse Width for MCP3905A, MCP3906A devices	t_{HW}	—	90	—	ms	322160 MCLK periods (Note 2)
F_{OUT0} and F_{OUT1} Pulse Width (Logic Low) for MCP3905L device	t_{FW}	—	130	—	ms	465344 MCLK periods (Note 1)
HF_{OUT} Pulse Width for MCP3905L device	t_{HW}	—	65	—	ms	232672 MCLK periods (Note 2)
F_{OUT0} and F_{OUT1} Pulse Period	t_{FP}	Refer to Equation 4-1			s	
HF_{OUT} Pulse Period	t_{HP}	Refer to Equation 4-2			s	
F_{OUT0} to F_{OUT1} Falling-Edge Time	t_{FS2}	—	$0.5 t_{FP}$	—		
F_{OUT0} to F_{OUT1} Min Separation	t_{FS}	—	$4/MCLK$	—		
F_{OUT0} and F_{OUT1} Output High Voltage	V_{OH}	4.5	—	—	V	$I_{OH} = 10 mA, DV_{DD} = 5.0V$
F_{OUT0} and F_{OUT1} Output Low Voltage	V_{OL}	—	—	0.5	V	$I_{OL} = 10 mA, DV_{DD} = 5.0V$
HF_{OUT} Output High Voltage	V_{OH}	4.0	—	—	V	$I_{OH} = 5 mA, DV_{DD} = 5.0V$
HF_{OUT} Output Low Voltage	V_{OL}	—	—	0.5	V	$I_{OL} = 5 mA, DV_{DD} = 5.0V$
High-Level Input Voltage (All Digital Input Pins)	V_{IH}	2.4	—	—	V	$DV_{DD} = 5.0V$
Low Level Input Voltage (All Digital Input Pins)	V_{IL}	—	—	0.85	V	$DV_{DD} = 5.0V$
Input Leakage Current		—	—	± 3	μA	$V_{IN} = 0, V_{IN} = DV_{DD}$
Pin Capacitance		—	—	10	pF	Note 3

- Note 1:** If output pulse period (t_{FP}) falls below $984376 * 2$ MCLK periods for MCP3905A/6A and $465344 * 2$ MCLK periods for MCP3905L, then $t_{FW} = 1/2 t_{FP}$
- 2:** If output pulse period (t_{HP}) falls below $322160 * 2$ MCLK periods for MCP3905A/6A and $232672 * 2$ MCLK periods for MCP3905L, then $t_{HW} = 1/2 t_{HP}$. When $F2, F1, F0 = 011$, t_{HW} is fixed to $18 \mu s$ (64 MCLK periods).
- 3:** Specified by characterization, not production tested.

MCP3905A/05L/06A

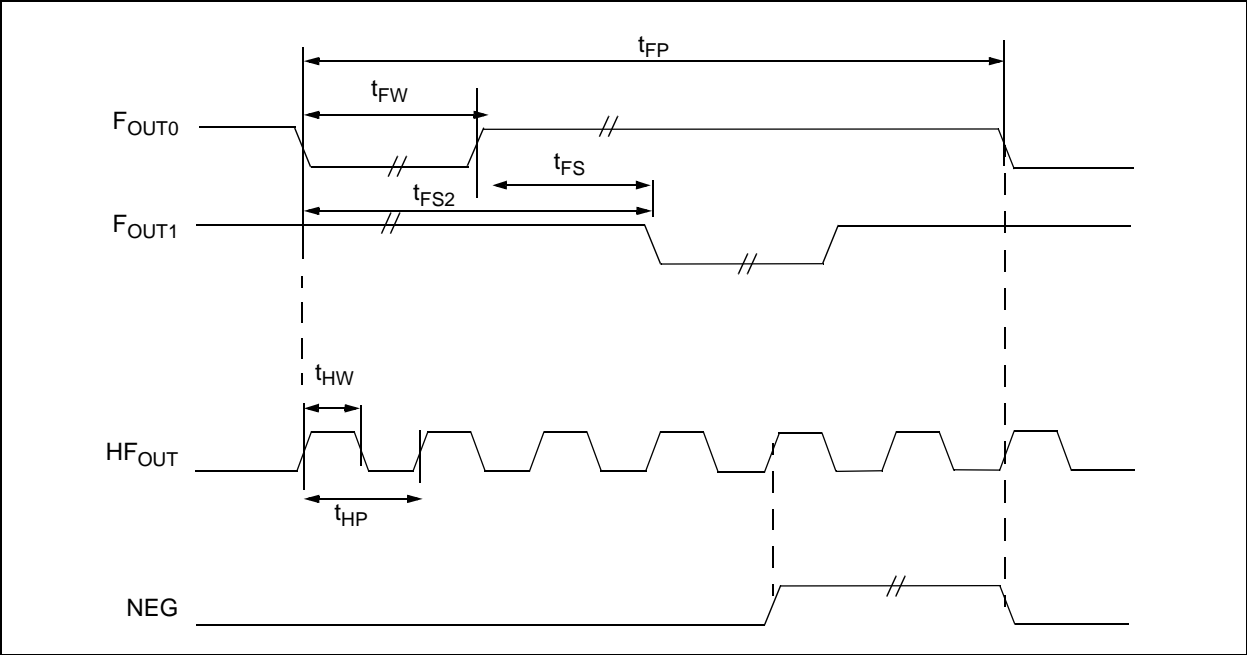

FIGURE 1-1: Output Timings for Pulse Outputs and Negative Power Pin.

2.0 TYPICAL PERFORMANCE CURVES

Note: The graphs and tables provided following this note are a statistical summary based on a limited number of samples and are provided for informational purposes only. The performance characteristics listed herein are not tested or guaranteed. In some graphs or tables, the data presented may be outside the specified operating range (e.g., outside specified power supply range) and therefore outside the warranted range.

Note: Unless otherwise specified, DV_{DD} , $AV_{DD} = 5V$; A_{GND} , $D_{GND} = 0V$; $V_{REF} = \text{Internal}$, $HPF = 1$ (AC mode), $MCLK = 3.58 \text{ MHz}$.

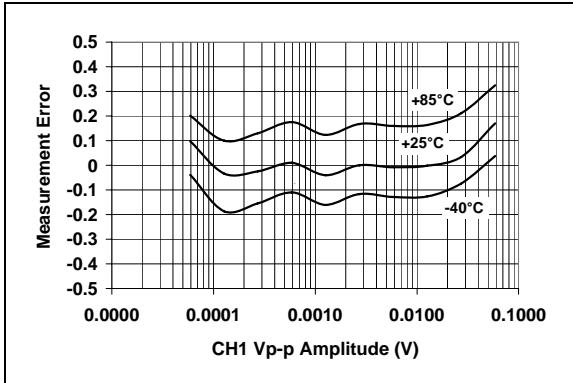

FIGURE 2-1: Measurement Error, Gain = 8 PF = 1.

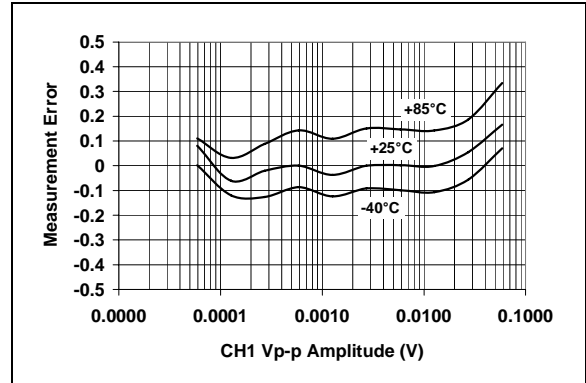

FIGURE 2-4: Measurement Error, Gain = 8, PF = 0.5.

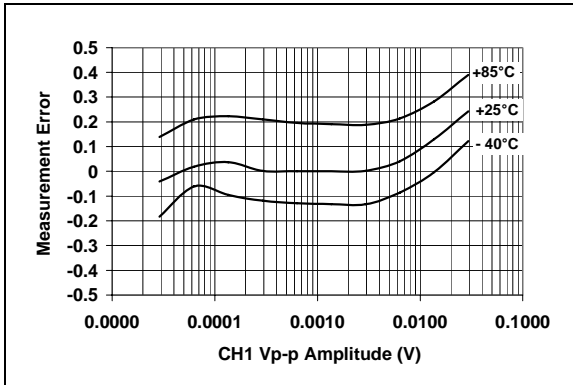

FIGURE 2-2: Measurement Error, Gain = 16, PF = 1.

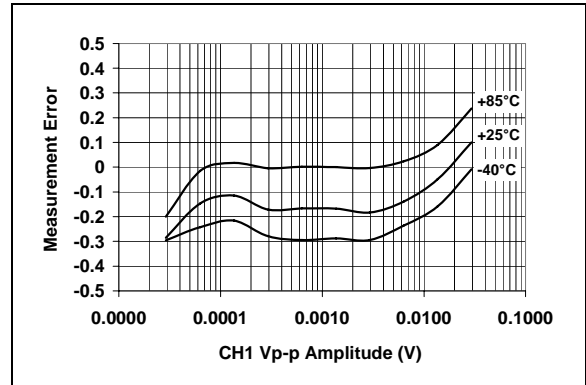

FIGURE 2-5: Measurement Error, Gain = 16, PF = 0.5.

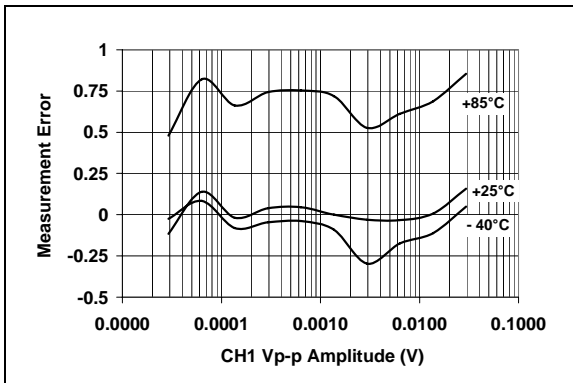

FIGURE 2-3: Measurement Error, Gain = 32, PF = 1.

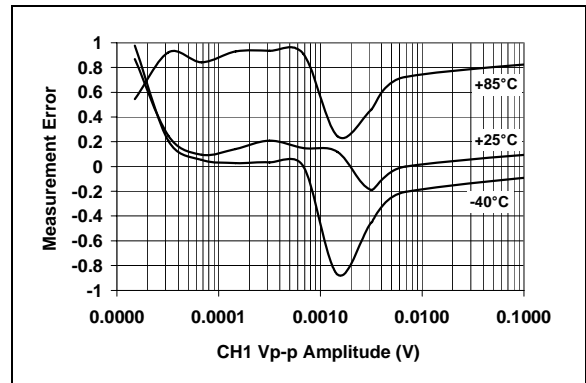

FIGURE 2-6: Measurement Error, Gain = 32, PF = 0.5.

MCP3905A/05L/06A

Note: Unless otherwise specified, DV_{DD} , $AV_{DD} = 5V$; A_{GND} , $D_{GND} = 0V$; $V_{REF} = \text{Internal}$, $HPF = 1$ (AC mode), $MCLK = 3.58 \text{ MHz}$.

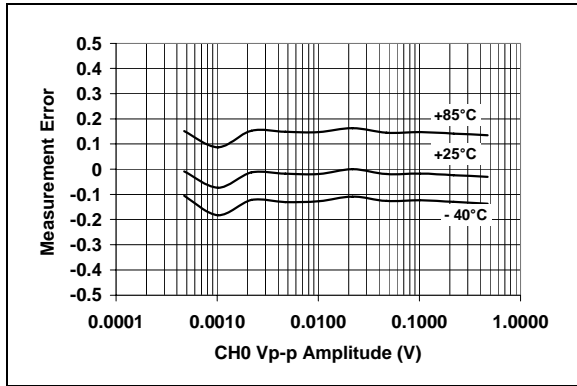

FIGURE 2-7: Measurement Error, Gain = 1, PF = 1.

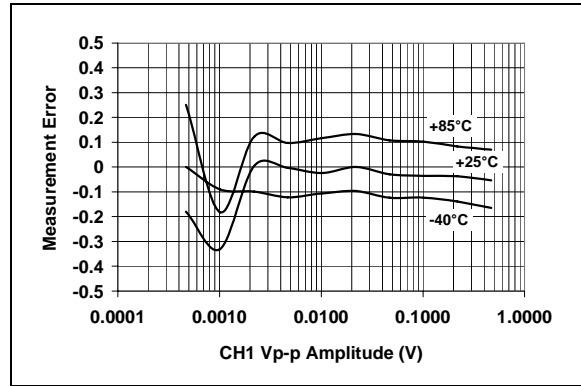

FIGURE 2-9: Measurement Error, Gain = 1, PF = + 0.5.

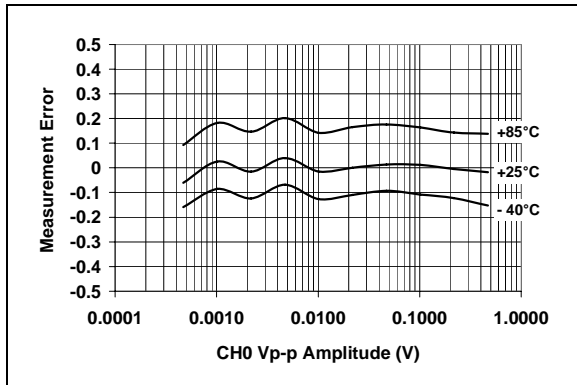

FIGURE 2-8: Measurement Error, Gain = 2, PF = 1.

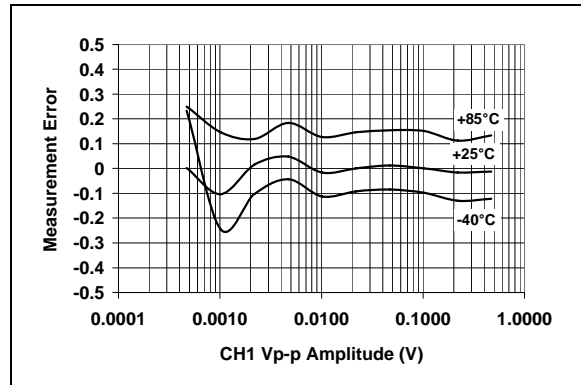

FIGURE 2-10: Measurement Error, Gain = 2, PF = + 0.5.

MCP3905A/05L/06A

Note: Unless otherwise specified, DV_{DD} , $AV_{DD} = 5V$; A_{GND} , $D_{GND} = 0V$; $V_{REF} = \text{Internal}$, $HPF = 1$ (AC mode), $MCLK = 3.58 \text{ MHz}$.

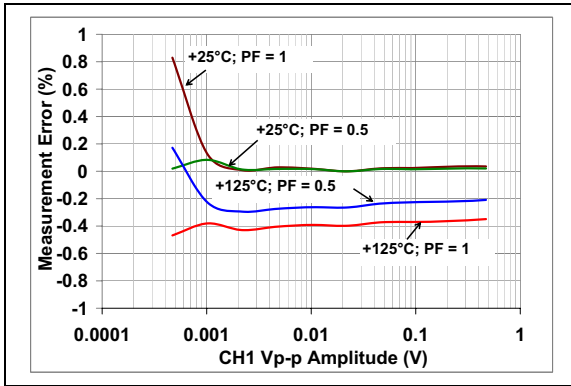

FIGURE 2-11: Measurement Error, Temperature = +125°C, Gain = 1.

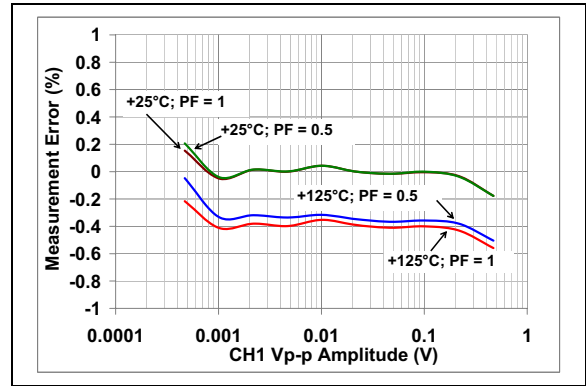

FIGURE 2-13: Measurement Error, Temperature = +125°C, Gain = 8.

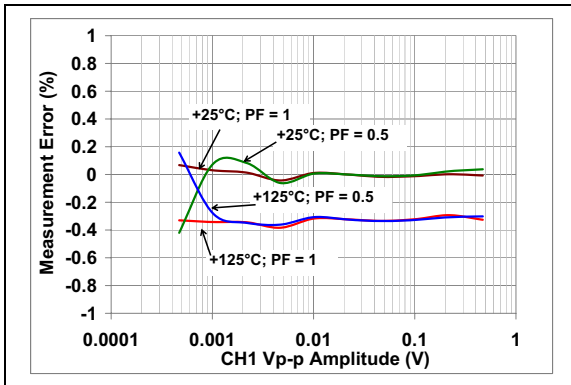

FIGURE 2-12: Measurement Error, Temperature = +125°C, Gain = 2.

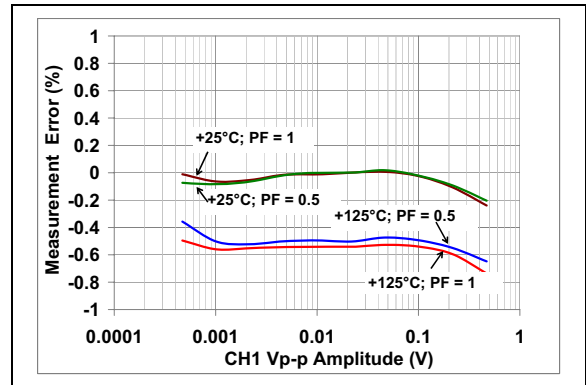

FIGURE 2-14: Measurement Error, Temperature = +125°C, Gain = 16.

MCP3905A/05L/06A

Note: Unless otherwise specified, V_{DD} , $A_{VDD} = 5V$; A_{GND} , $D_{GND} = 0V$; $V_{REF} = \text{Internal}$, $HPF = 1$ (AC mode), $MCLK = 3.58 \text{ MHz}$.

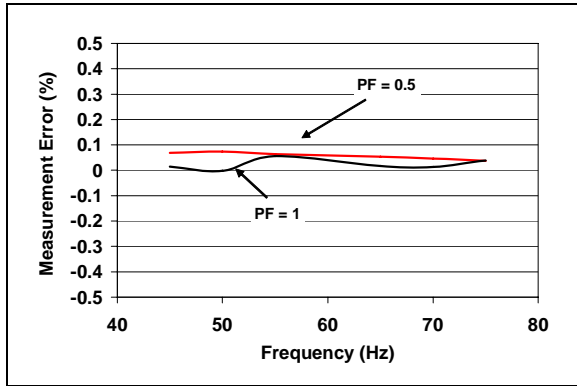

FIGURE 2-15: Measurement Error vs. Input Frequency.

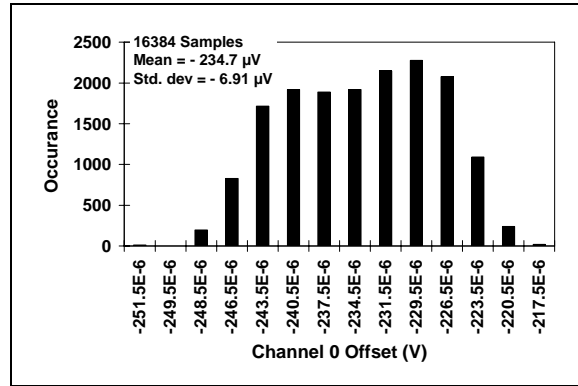

FIGURE 2-18: Channel 0 Offset Error (DC Mode, HPF Off), $G = 16$.

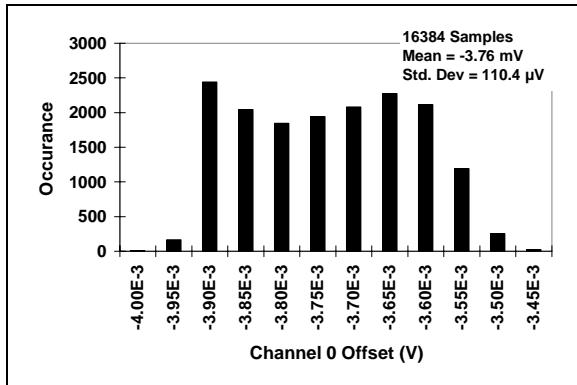

FIGURE 2-16: Channel 0 Offset Error (DC Mode, HPF off), $G = 1$.

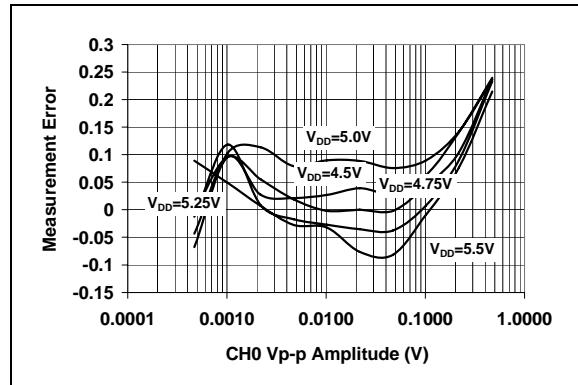

FIGURE 2-19: Measurement Error vs. V_{DD} ($G = 16$).

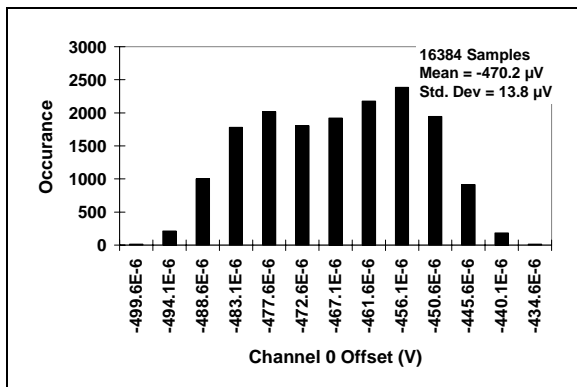

FIGURE 2-17: Channel 0 Offset Error (DC Mode, HPF off), $G = 8$.

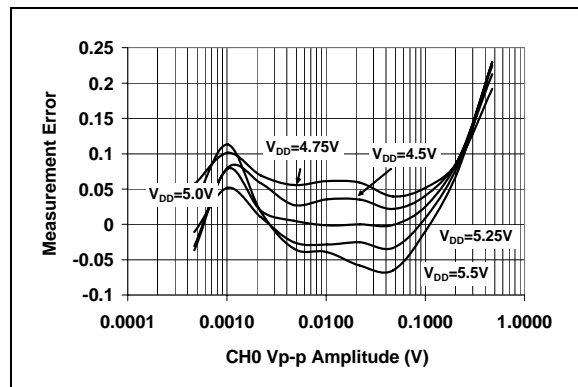

FIGURE 2-20: Measurement Error vs. V_{DD} , $G = 16$, External V_{REF} .

MCP3905A/05L/06A

Note: Unless otherwise specified, DV_{DD} , $AV_{DD} = 5V$; A_{GND} , $D_{GND} = 0V$; $V_{REF} = \text{Internal}$, $HPF = 1$ (AC mode), $MCLK = 3.58 \text{ MHz}$.

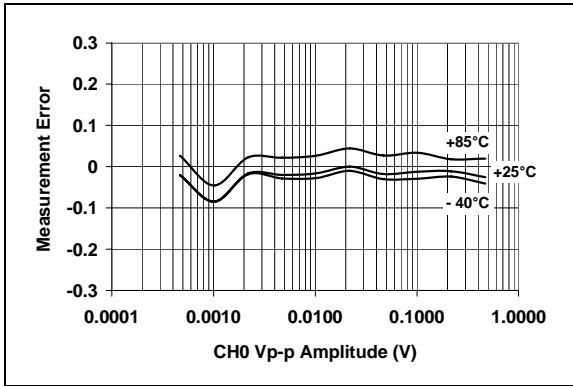

FIGURE 2-21: Measurement Error w/ External V_{REF} ($G = 1$).

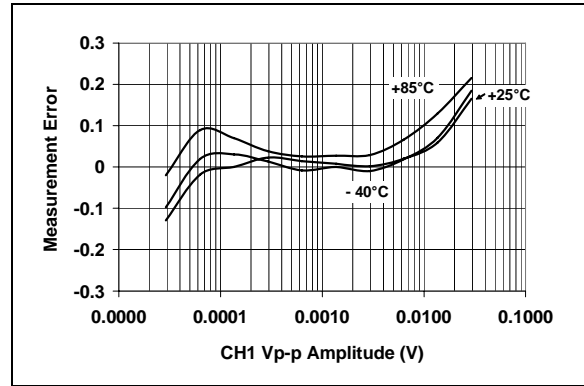

FIGURE 2-23: Measurement Error w/ External V_{REF} ($G = 16$).

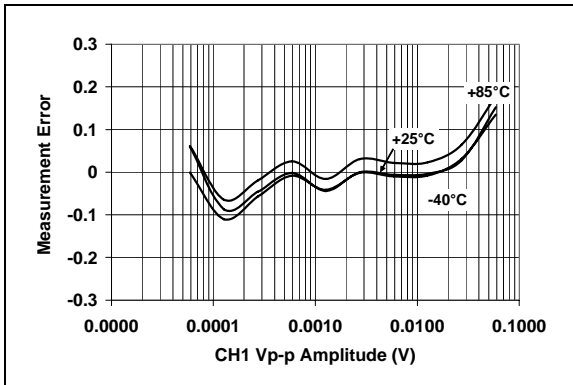

FIGURE 2-22: Measurement Error w/ External V_{REF} ($G = 8$).

MCP3905A/05L/06A

NOTES:

3.0 PIN DESCRIPTIONS

The descriptions of the pins are listed in [Table 3-1](#).

TABLE 3-1: PIN FUNCTION TABLE

Pin No.	Symbol	Function
1	DV _{DD}	Digital Power Supply Pin
2	HPF	High-Pass Filters Control Logic Pin
3	AV _{DD}	Analog Power Supply Pin
4	NC	No Connect
5	CH0+	Non-Inverting Analog Input Pin for Channel 0 (Current Channel)
6	CH0-	Inverting Analog Input Pin for Channel 0 (Current Channel)
7	CH1-	Inverting Analog Input Pin for Channel 1 (Voltage Channel)
8	CH1+	Non-Inverting Analog Input Pin for Channel 1 (Voltage Channel)
9	MCLR	Master Clear Logic Input Pin
10	REFIN/OUT	Voltage Reference Input/Output Pin
11	A _{GND}	Analog Ground Pin, Return Path for internal analog circuitry
12	F2	Frequency Control for HF _{OUT} Logic Input Pin
13	F1	Frequency Control for F _{OUT0/1} Logic Input Pin
14	F0	Frequency Control for F _{OUT0/1} Logic Input Pin
15	G1	Gain Control Logic Input Pin
16	G0	Gain Control Logic Input Pin
17	OSC1	Oscillator Crystal Connection Pin or Clock Input Pin
18	OSC2	Oscillator Crystal Connection Pin or Clock Output Pin
19	NC	No Connect
20	NEG	Negative Power Logic Output Pin
21	D _{GND}	Digital Ground Pin, Return Path for Internal Digital Circuitry
22	HF _{OUT}	High-Frequency Logic Output Pin (Intended for Calibration)
23	F _{OUT1}	Differential Mechanical Counter Logic Output Pin
24	F _{OUT0}	Differential Mechanical Counter Logic Output Pin

3.1 Digital V_{DD} (DV_{DD})

DV_{DD} is the power supply pin for the digital circuitry within the MCP3905A/05L/06A devices.

This pin requires appropriate bypass capacitors and should be maintained to 5V ±10% for specified operation. Refer to [Section 5.0 “Applications Information”](#).

3.2 High-Pass Filter Input Logic Pin (HPF)

HPF controls the state of the high-pass filter in both input channels. A logic ‘1’ enables both filters, removing any DC offset coming from the system or the device. A logic ‘0’ disables both filters, allowing DC voltages to be measured.

3.3 Analog V_{DD} (AV_{DD})

AV_{DD} is the power supply pin for the analog circuitry within the MCP3905A/05L/06A devices.

This pin requires appropriate bypass capacitors and should be maintained to 5V ±10% for specified operation. Refer to [Section 5.0 “Applications Information”](#).

3.4 Current Channel (CH0-, CH0+)

CH0- and CH0+ are the fully differential analog voltage input channels for the current measurement, containing a PGA for small-signal input, such as shunt current sensing. The linear and specified region of this channel is dependant on the PGA gain. This corresponds to a maximum differential voltage of ±470 mV/GAIN and maximum absolute voltage, with respect to A_{GND}, of ±1V. Up to ±6V can be applied to these pins without the risk of permanent damage.

Refer to [Section 1.0 “Electrical Characteristics”](#).

MCP3905A/05L/06A

3.5 Voltage Channel (CH1-,CH1+)

CH1- and CH1+ are the fully differential analog voltage input channels for voltage measurement. The linear and specified region of these channels have a maximum differential voltage of ± 660 mV and a maximum absolute voltage of ± 1 V, with respect to A_{GND} . Up to ± 6 V can be applied to these pins without the risk of permanent damage.

Refer to [Section 1.0 “Electrical Characteristics”](#).

3.6 Master Clear (MCLR)

MCLR controls the reset for both delta-sigma ADCs, all digital registers, the SINC filters for each channel and all accumulators post multiplier. A logic '0' resets all registers and holds both ADCs in a Reset condition. The charge stored in both ADCs is flushed and their output is maintained to 0x0000h. The only block consuming power on the digital power supply during Reset is the oscillator circuit.

3.7 Reference (REFIN/OUT)

REFIN/OUT is the output for the internal 2.4V reference. This reference has a typical temperature coefficient of 15 ppm/°C and a tolerance of $\pm 2\%$. In addition, an external reference can also be used by applying voltage to this pin within the specified range. This pin requires appropriate bypass capacitors to A_{GND} , even when using the internal reference only. Refer to [Section 5.0 “Applications Information”](#).

3.8 Analog Ground (A_{GND})

A_{GND} is the ground connection to internal analog circuitry (ADCs, PGA, band gap reference, POR). To ensure accuracy and noise cancellation, this pin must be connected to the same ground as D_{GND} , preferably with a star connection. If an analog ground plane is available, it is recommended that this device be tied to this plane of the PCB. This plane should also reference all other analog circuitry in the system.

3.9 Frequency Control Logic Pins (F2, F1, F0)

F2, F1 and F0 select the high-frequency output and low-frequency output pin ranges by changing the value of the constants F_C and H_{FC} used in the device transfer function. F_C and H_{FC} are the frequency constants that define the period of the output pulses for the device.

3.10 Gain Control Logic Pins (G1, G0)

G1 and G0 select the PGA gain on Channel 0 from three different values: 1, 8 and 16.

3.11 Oscillator (OSC1, OSC2)

OSC1 and OSC2 provide the master clock for the device. A resonant crystal or clock source with a similar sinusoidal waveform must be placed across these pins to ensure proper operation. The typical clock frequency specified is 3.579545 MHz. However, the clock frequency can be with the range of 1 MHz to 4 MHz without disturbing measurement error. Appropriate load capacitance should be connected to these pins for proper operation.

A full-swing, single-ended clock source may be connected to OSC1 with proper resistors in series to ensure no ringing of the clock source due to fast transient edges.

3.12 Negative Power Output Logic Pin (NEG)

NEG detects the phase difference between the two channels and will go to a logic '1' state when the phase difference is greater than 90° (i.e., when the measured real power is negative). The output state is synchronous with the rising-edge of HF_{OUT} and maintains the logic '1' until the real power becomes positive again and HF_{OUT} shows a pulse.

3.13 Ground Connection (D_{GND})

D_{GND} is the ground connection to internal digital circuitry (SINC filters, multiplier, HPF, LPF, digital-to-frequency converter and oscillator). To ensure accuracy and noise cancellation, D_{GND} must be connected to the same ground as A_{GND} , preferably with a star connection. If a digital ground plane is available, it is recommended that this device be tied to this plane of the Printed Circuit Board (PCB). This plane should also reference all other digital circuitry in the system.

3.14 High-Frequency Output (HF_{OUT})

HF_{OUT} is the high-frequency output of the device and supplies the instantaneous real-power information. The output is a periodic pulse output, with its period proportional to the measured real power, and to the HF_C constant defined by F0, F1 and F2 pin logic states. This output is the preferred output for calibration due to faster output frequencies, giving smaller calibration times. Since this output gives instantaneous real power, the 2ω ripple on the output should be noted. However, the average period will show minimal drift.

3.15 Frequency Output (F_{OUT0} , F_{OUT1})

F_{OUT0} and F_{OUT1} are the frequency outputs of the device that supply the average real-power information. The outputs are periodic pulse outputs, with its period proportional to the measured real power, and to the F_C constant, defined by F0 and F1 pin logic states. These pins include high-output drive capability for direct use of electromechanical counters and 2-phase stepper motors. Since this output supplies average real power, any 2ω ripple on the output pulse period is minimal.

4.0 DEVICE OVERVIEW

The MCP3905A/05L/06A devices are energy metering ICs that supply a frequency output proportional to active (real) power, and higher frequency output proportional to the instantaneous power for meter calibration. Both channels use 16-bit, second-order, delta-sigma ADCs that oversample the input at a frequency equal to $MCLK/4$, allowing for wide dynamic range input signals. A Programmable Gain Amplifier (PGA) increases the usable range on the current input channel (Channel 0). The calculation of the active power, and the filtering associated with this calculation is performed in the digital domain, ensuring better stability and drift performance. Figure 4-1 represents the simplified block diagram of the MCP3905A/05L/06A, detailing its main signal processing blocks.

Two digital high-pass filters cancel the system offset on both channels such that the real-power calculation does not include any circuit or system offset. After being high-pass filtered, the voltage and current signals are multiplied to give the instantaneous power signal. This signal does not contain the DC offset components, such that the averaging technique can be efficiently used to give the desired active-power output.

The instantaneous power signal contains the real-power information; it is the DC component of the instantaneous power. The averaging technique can be used with both sinusoidal and non-sinusoidal waveforms, as well as for all power factors. The instantaneous power is thus low-pass filtered in order to produce the instantaneous real-power signal.

A digital-to-frequency converter accumulates the instantaneous active real power information to produce output pulses with a frequency proportional to the average real power. The low-frequency pulses present at the F_{OUT0} and F_{OUT1} outputs are designed to drive electromechanical counters and two-phase stepper motors displaying the real-power energy consumed. Each pulse corresponds to a fixed quantity of real energy, selected by the F2, F1 and F0 logic settings. The HF_{OUT} output has a higher frequency setting and less integration period such that it can represent the instantaneous real-power signal. Due to the shorter accumulation time, it enables the user to proceed to faster calibration under steady load conditions (see Section 4.7 “ $F_{OUT0/1}$ and HF_{OUT} Output Frequencies”).

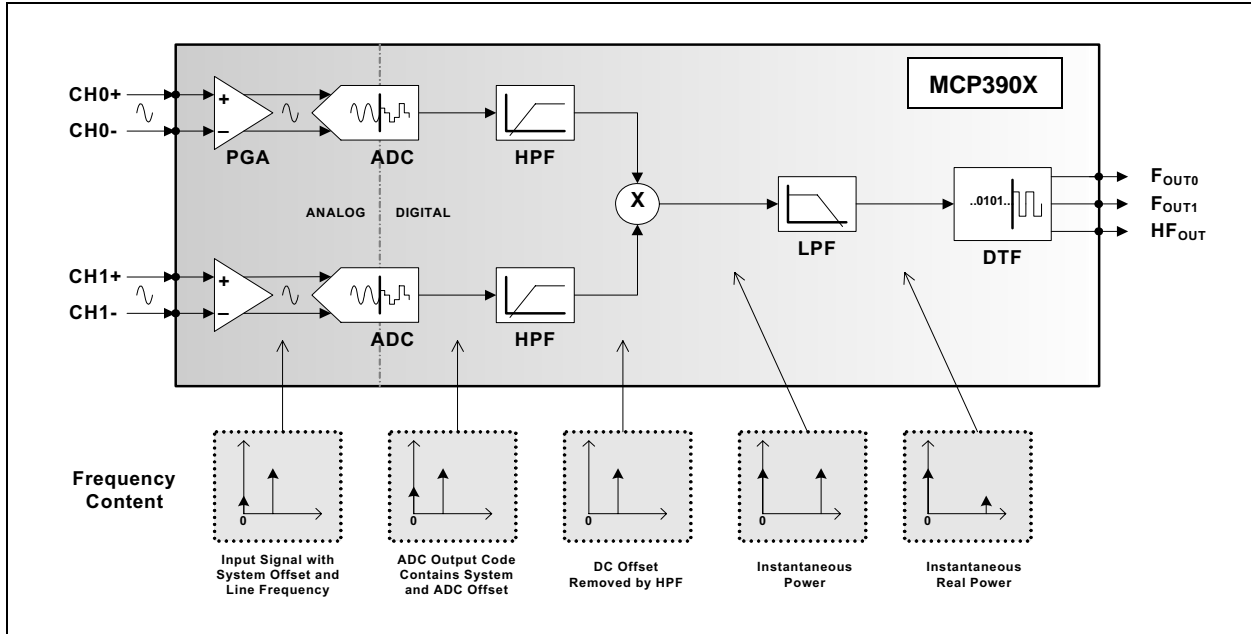

FIGURE 4-1: Simplified MCP3905A/05L/06A Block Diagram with Frequency Contents.

MCP3905A/05L/06A

4.1 Analog Inputs

The MCP3905A/05L/06A analog inputs can be connected directly to the current and voltage transducers (such as shunts or current transformers). Each input pin is protected by specialized ESD structures that are certified to pass 5 kV HBM and 500V MM contact charge. These structures also allow up to $\pm 6V$ continuous voltage to be present at their inputs without the risk of permanent damage.

Both channels have fully differential voltage inputs for better noise performance. The absolute voltage at each pin relative to A_{GND} should be maintained in the $\pm 1V$ range during operation in order to ensure the measurement error performance. The common-mode signals should be adapted to respect both the previous conditions and the differential input voltage range. For best performance, the common-mode signals should be referenced to A_{GND} .

The current channel comprises a PGA on the front-end to allow for smaller signals to be measured without additional signal conditioning. The maximum differential voltage specified on Channel 0 is equal to ± 470 mV/Gain (see Table 4-1). The maximum peak voltage specified on Channel 1 is equal to ± 660 mV.

TABLE 4-1: MCP3905A/MCP3905L GAIN SELECTIONS

G1	G0	CH0 Gain	Maximum CH0 Voltage
0	0	1	± 470 mV
0	1	2	± 235 mV
1	0	8	± 60 mV
1	1	16	± 30 mV

TABLE 4-2: MCP3906A GAIN SELECTIONS

G1	G0	CH0 Gain	Maximum CH0 Voltage
0	0	1	± 470 mV
0	1	32	± 15 mV
1	0	8	± 60 mV
1	1	16	± 30 mV

4.2 16-Bit Delta-Sigma A/D Converters

The ADCs used in the MCP3905A/05L/06A for both current and voltage channel measurements are delta-sigma ADCs. They comprise a second-order, delta-sigma modulator using a multi-bit DAC and a third-order SINC filter. The delta-sigma architecture is very appropriate for the applications targeted by the MCP3905A/05L/06A because it is a waveform-oriented converter architecture that can offer both high linearity and low distortion performance throughout a wide input dynamic range. It also creates minimal requirements for the anti-aliasing filter design. The multi-bit architecture used in the ADC minimizes quantization noise at the output of the converters without disturbing the linearity.

Both ADCs have a 16-bit resolution, allowing wide input dynamic range sensing. The oversampling ratio of both converters is 64. Both converters are continuously converting during normal operation. When the \overline{MCLR} pin is low, both converters will be in Reset and output code 0x0000h. If the voltage at the inputs of the ADC is larger than the specified range, the linearity is no longer specified. However, the converters will continue to produce output codes until their saturation point is reached. The DC saturation point is around 700 mV for Channel 0 and 1V for Channel 1, using internal voltage reference.

The clocking signals for the ADCs are equally distributed between the two channels in order to minimize phase delays to less than 1 MCLK period (see Section 3.2 “High-Pass Filter Input Logic Pin (HPF)”). The SINC filter’s main notch is positioned at $MCLK/256$ (14 kHz with $MCLK = 3.58$ MHz), allowing the user to be able to measure wide harmonic content on either channel. The magnitude response of the SINC filter is shown in Figure 4-2.

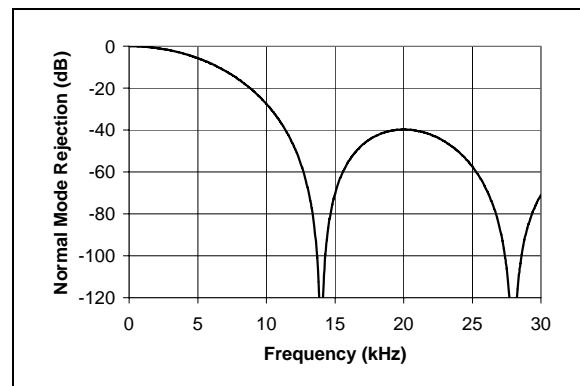

FIGURE 4-2: SINC Filter Magnitude Response ($MCLK = 3.58$ MHz).

4.3 Ultra-Low Drift V_{REF}

The MCP3905A/05L/06A devices contain an internal voltage reference source specially designed to minimize drift over temperature. This internal V_{REF} supplies reference voltage to both current and voltage channel ADCs. The typical value of this voltage reference is $2.4V \pm 100\text{ mV}$. The internal reference has a very low typical temperature coefficient of $\pm 15\text{ ppm}/^\circ\text{C}$, allowing the output frequencies to have minimal variation with respect to temperature since they are proportional to $(1/V_{REF})^2$.

The output pin for the voltage reference is REFIN/OUT. Appropriate bypass capacitors must be connected to the REFIN/OUT pin for proper operation (see [Section 5.0 “Applications Information”](#)). The voltage reference source impedance is typically $4\text{ k}\Omega$, which enables this voltage reference to be overdriven by an external voltage reference source.

If an external voltage reference source is connected to the REFIN/OUT pin, the external voltage will be used as the reference for both current and voltage channel ADCs. The voltage across the source resistor will then be the difference between the internal and external voltage. The allowed input range for the external voltage source goes from $2.2V$ to $2.6V$ for accurate measurement error. A V_{REF} value outside of this range will cause additional heating and power consumption due to the source resistor, which might affect measurement error.

4.4 Power-On Reset (POR)

The MCP3905A/05L/06A devices contain an internal POR circuit that monitors analog supply voltage AV_{DD} during operation. This circuit ensures correct device startup at system power-up and system power-down events. The POR circuit has built-in hysteresis and a timer to give a high degree of immunity to potential ripple and noise on the power supplies, allowing proper settling of the power supply during power-up. A $0.1\text{ }\mu\text{F}$ decoupling capacitor should be mounted as close as possible to the AV_{DD} pin, providing additional transient immunity (see [Section 5.0 “Applications Information”](#)).

The threshold voltage is typically set at $4V$, with a tolerance of about $\pm 5\%$. If the supply voltage falls below this threshold, the MCP3905A/05L/06A devices will be held in a Reset condition (equivalent to applying logic ‘0’ on the $\overline{\text{MCLR}}$ pin). The typical hysteresis value is approximately 200 mV in order to prevent glitches on the power supply.

Once a power-up event has occurred, an internal timer prevents the part from outputting any pulse for approximately 1 s (with $\text{MCLK} = 3.58\text{ MHz}$), thereby preventing potential metastability due to intermittent resets caused by an unsettled regulated power supply.

Figure 4-3 illustrates the different conditions for a power-up and a power-down event in the typical conditions.

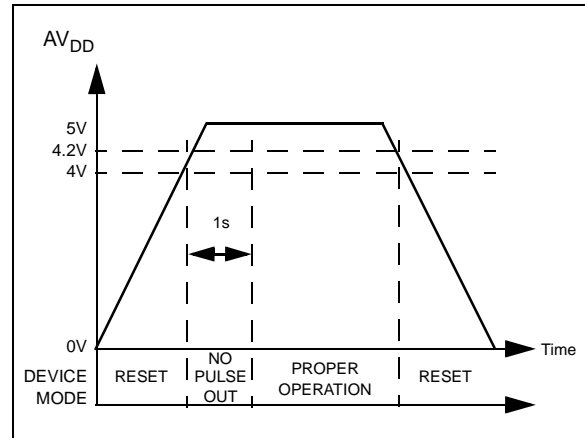

FIGURE 4-3: Power-on Reset Operation.

4.5 High-Pass Filters and Multiplier

The active real-power value is extracted from the DC instantaneous power. Therefore, any DC offset component present on Channel 0 and Channel 1 affects the DC component of the instantaneous power and will cause the real-power calculation to be erroneous. In order to remove DC offset components from the instantaneous power signal, a high-pass filter has been introduced on each channel. Since the high-pass filtering introduces phase delay, identical high-pass filters are implemented on both channels. The filters are clocked by the same digital signal, ensuring a phase difference between the two channels of less than one MCLK period. Under typical conditions ($\text{MCLK} = 3.58\text{ MHz}$), this phase difference is less than 0.005° , with a line frequency of 50 Hz . The cut-off frequency of the filter (4.45 Hz) has been chosen to induce minimal gain error at typical line frequencies, allowing sufficient settling time for the desired applications. The two high-pass filters can be disabled by applying logic ‘0’ to the HPF pin.

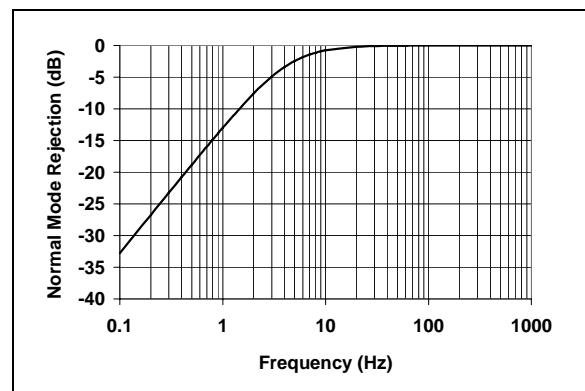

FIGURE 4-4: HPF Magnitude Response ($\text{MCLK} = 3.58\text{ MHz}$).

MCP3905A/05L/06A

The multiplier output gives the product of the two high-pass filtered channels, corresponding to instantaneous real power. Multiplying two sine wave signals by the same ω frequency gives a DC component and a 2ω component. The instantaneous power signal contains the real power of its DC component, while also containing 2ω components coming from the line frequency multiplication. These 2ω components come for the line frequency (and its harmonics) and must be removed in order to extract the real-power information. This is accomplished using the low-pass filter and DTF converter.

4.6 Low-Pass Filter and DTF Converter

The MCP3905A/05L/06A low-pass filter is a first-order IIR filter that extracts the active real-power information (DC component) from the instantaneous power signal. The magnitude response of this filter is detailed in Figure 4-5. Due to the fact that the instantaneous power signal has harmonic content (coming from the 2ω components of the inputs), and since the filter is not ideal, there will be some ripple at the output of the low-pass filter at the harmonics of the line frequency.

The cut-off frequency of the filter (8.9 Hz) has been chosen to have sufficient rejection for commonly-used line frequencies (50 Hz and 60 Hz). With a standard input clock (MCLK = 3.58 MHz) and a 50 Hz line frequency, the rejection of the 2ω component (100 Hz) will be more than 20 dB. This equates to a 2ω component containing 10 times less power than the main DC component (i.e., the average active real power).

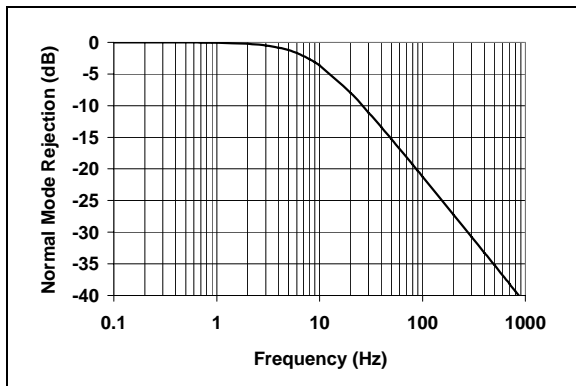

FIGURE 4-5: LPF Magnitude Response (MCLK = 3.58 MHz).

The output of the low-pass filter is accumulated in the digital-to-frequency converter. This accumulation is compared to a different digital threshold for $F_{OUT0/1}$ and HF_{OUT} , representing a quantity of real energy measured by the part. Every time the digital threshold on $F_{OUT0/1}$ or HF_{OUT} is crossed, the part will output a pulse (See Section 4.7 “ $F_{OUT0/1}$ and HF_{OUT} Output Frequencies”).

The equivalent quantity of real energy required to output a pulse is much larger for the $F_{OUT0/1}$ outputs than the HF_{OUT} . This is such that the integration period for the $F_{OUT0/1}$ outputs is much larger. This larger integration period acts as another low-pass filter so that the output ripple due to the 2ω components is minimal. However, these components are not totally removed, since realized low-pass filters are never ideal. This will create a small jitter in the output frequency. Averaging the output pulses with a counter or a MCU in the application will then remove the small sinusoidal content of the output frequency and filter out the remaining 2ω ripple.

HF_{OUT} is intended to be used for calibration purposes due to its instantaneous power content. The shorter integration period of HF_{OUT} demands that the 2ω component be given more attention. Since a sinusoidal signal average is zero, averaging the HF_{OUT} signal in steady-state conditions will give the proper real energy value.

4.7 $F_{OUT0/1}$ and HF_{OUT} Output Frequencies

The thresholds for the accumulated energy are different for $F_{OUT0/1}$ and HF_{OUT} (i.e., they have different transfer functions). The $F_{OUT0/1}$ allowed output frequencies are quite low in order to allow superior integration time (see Section 4.6 “Low-Pass Filter and DTF Converter”). The $F_{OUT0/1}$ output frequency can be calculated with the following equation:

EQUATION 4-1: F_{OUT} FREQUENCY OUTPUT EQUATION

$$F_{OUT}(Hz) = \frac{8.06 \times V_0 \times V_1 \times G \times F_C}{(V_{REF})^2}$$

Where:

- V_0 is the RMS differential voltage on Channel 0
- V_1 is the RMS differential voltage on Channel 1
- G is the PGA gain on Channel 0 (current channel)
- F_C is the frequency constant selected
- V_{REF} is the voltage reference

For a given DC input V , the DC and RMS values are equivalent. For a given AC input signal with peak-to-peak amplitude of V , the equivalent RMS value is $V/\sqrt{2}$, assuming purely sinusoidal signals. Note that since the real power is the product of two RMS inputs, the output frequencies of AC signals are half of the DC inputs ones, again assuming purely sinusoidal AC signals. The constant F_C depends on the F_{OUT0} and F_{OUT1} digital settings. Table 4-3 shows $F_{OUT0/1}$ output frequencies for the different logic settings.

MCP3905A/05L/06A

The high-frequency output HF_{OUT} has lower integration times and, thus, higher frequencies. The output frequency value can be calculated with the following equation:

EQUATION 4-2: HF_{OUT} FREQUENCY OUTPUT EQUATION

$$HF_{OUT}(Hz) = \frac{8.06 \times V_0 \times V_1 \times G \times HF_C}{(V_{REF})^2}$$

Where:

V₀ is the RMS differential voltage on channel 0
V₁ is the RMS differential voltage on channel 1
G is the PGA gain on channel 0 (current channel)
HF_C is the frequency constant selected
V_{REF} is the voltage reference

The constant HF_C depends on the F_{OUT0} and F_{OUT1} digital settings with the [Table 4-4](#).

The detailed timings of the output pulses are described in the [Timing Characteristics](#) table (see [Section 1.0 "Electrical Characteristics"](#) and [Figure 1-1](#)).

4.7.1 MINIMAL OUTPUT FREQUENCY FOR NO-LOAD THRESHOLD

The MCP3905A/05L/06A devices also include, on each output frequency, a no-load threshold circuit that will eliminate any creep effects in the meter. The outputs will not show any pulse if the output frequency falls below the no-load threshold. The minimum output frequency on F_{OUT0/1} and HF_{OUT} is equal to 0.0015% of the maximum output frequency (respectively F_C and HF_C) for each of the F2, F1 and F0 selections (see [Table 4-3](#) and [Table 4-4](#)); except when F2, F1, F0 = 011. In this last configuration, the no-load threshold feature is disabled. The selection of F_C will determine the start-up current load. In order to respect the IEC standards requirements, the meter will have to be designed to allow start-up currents compatible with the standards by choosing the FC value matching these requirements. For additional applications information on no-load threshold, startup current and other meter design points, refer to AN994, "IEC Compliant Active Energy Meter Design Using The MCP3905/6", (DS00994).

TABLE 4-3: MCP3905L OUTPUT FREQUENCY SETTINGS

F2	F1	F0	HF _C	HF _C (Hz)	HF _C (Hz), MCLK=3.58 MHz	HF _{OUT} (Hz), w/ full scale AC inputs	F _C (Hz)	F _C (Hz), MCLK=3.58 MHz
0	0	0	64XF _C	MCLK/2 ¹⁵	109.25	23.71	MCLK/2 ²¹	1.71
0	0	1	32XF _C	MCLK/2 ¹⁵	109.25	23.71	MCLK/2 ²⁰	3.41
0	1	0	16XF _C	MCLK/2 ¹⁵	109.25	23.71	MCLK/2 ¹⁹	6.83
0	1	1	2048XF _C	MCLK/2 ⁷	27968.75	6070.12	MCLK/2 ¹⁸	13.66
1	0	0	8XF _C	MCLK/2 ¹⁶	54.62	11.85	MCLK/2 ¹⁹	6.83
1	0	1	64XF _C	MCLK/2 ¹⁶	54.62	11.85	MCLK/2 ²²	0.85
1	1	0	32XF _C	MCLK/2 ¹⁶	54.62	11.85	MCLK/2 ²¹	1.71
1	1	1	16XF _C	MCLK/2 ¹⁶	54.62	11.85	MCLK/2 ²⁰	3.41

TABLE 4-4: MCP3905A/06A OUTPUT FREQUENCY SETTINGS

F2	F1	F0	HF _C	HF _C (Hz)	HF _C (Hz), MCLK=3.58 MHz	HF _{OUT} (Hz), w/ full scale AC inputs	F _C (Hz)	F _C (Hz), MCLK=3.58 MHz
0	0	0	64XF _C	MCLK/2 ¹⁵	109.25	23.71	MCLK/2 ²¹	1.71
0	0	1	32XF _C	MCLK/2 ¹⁵	109.25	23.71	MCLK/2 ²⁰	3.41
0	1	0	16XF _C	MCLK/2 ¹⁵	109.25	23.71	MCLK/2 ¹⁹	6.83
0	1	1	2048XF _C	MCLK/2 ⁷	27968.75	6070.12	MCLK/2 ¹⁸	13.66
1	0	0	128XF _C	MCLK/2 ¹⁴	219.51	47.42	MCLK/2 ²¹	1.71
1	0	1	64XF _C	MCLK/2 ¹⁴	219.51	47.42	MCLK/2 ²⁰	3.41
1	1	0	32XF _C	MCLK/2 ¹⁴	219.51	47.42	MCLK/2 ¹⁹	6.83
1	1	1	16XF _C	MCLK/2 ¹⁴	219.51	47.42	MCLK/2 ¹⁸	13.66

MCP3905A/05L/06A

NOTES:

5.0 APPLICATIONS INFORMATION

5.1 Meter Design using the MCP3905A/05L/06A

For all applications information, refer to AN994, "*IEC Compliant Active Energy Meter Design Using The MCP3905/6*" (DS00994). This application note includes all required energy meter design information, including the following:

- Meter rating and current sense choices
- Shunt design
- PGA selection
- F2, F1, F0 selection
- Meter calibration
- Anti-aliasing filter design
- Compensation for parasitic shunt inductance
- EMC design
- Power supply design
- No-Load threshold
- Start-up current
- Accuracy Testing Results from MCP3905-based meter
- EMC Testing Results from MCP3905-based meter

MCP3905A/05L/06A

NOTES:

6.0 PACKAGING INFORMATION

6.1 Package Marking Information

24-Lead SSOP

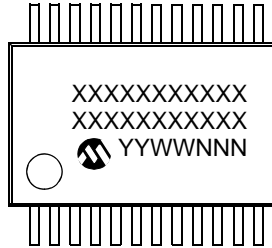

Examples:

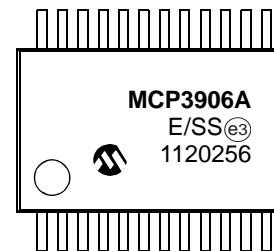
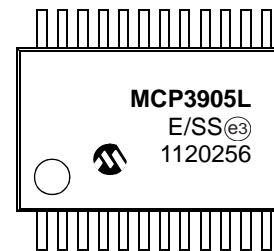
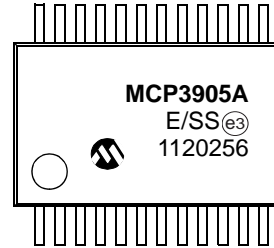

Legend:	XX...X	Customer-specific information
	Y	Year code (last digit of calendar year)
	YY	Year code (last 2 digits of calendar year)
	WW	Week code (week of January 1 is week '01')
	NNN	Alphanumeric traceability code
	(e3)	Pb-free JEDEC designator for Matte Tin (Sn)
	*	This package is Pb-free. The Pb-free JEDEC designator (e3) can be found on the outer packaging for this package.

Note: In the event the full Microchip part number cannot be marked on one line, it will be carried over to the next line, thus limiting the number of available characters for customer-specific information.

MCP3905A/05L/06A

24-Lead Plastic Shrink Small Outline (SS) – 5.30 mm Body [SSOP]

Note: For the most current package drawings, please see the Microchip Packaging Specification located at <http://www.microchip.com/packageing>

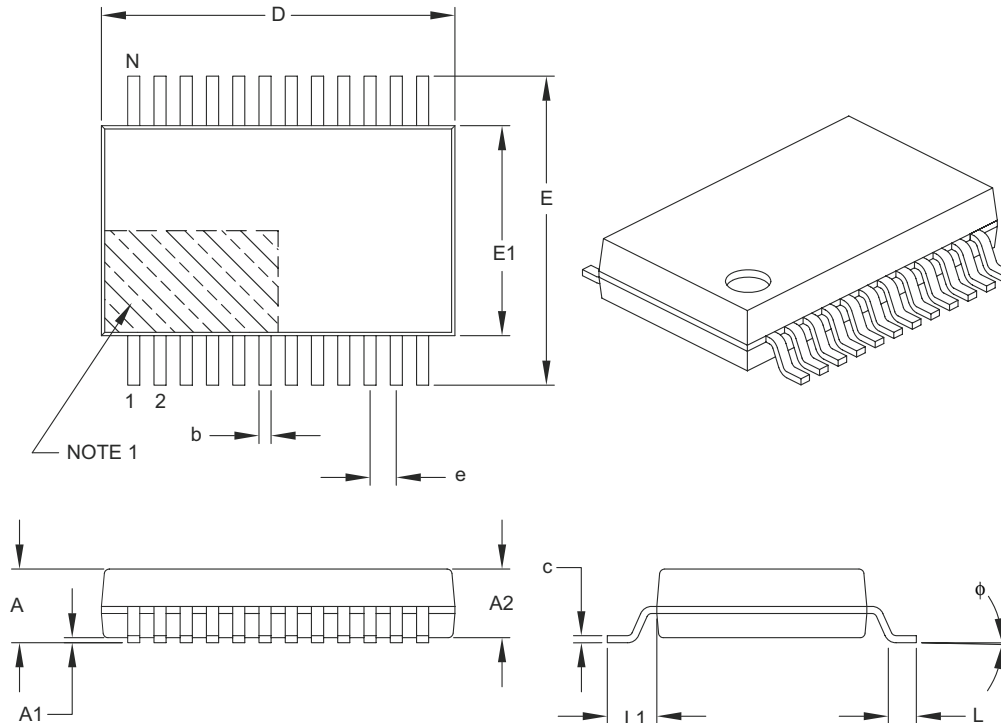

Dimension Limits	Units	MILLIMETERS		
		MIN	NOM	MAX
Number of Pins	N	24		
Pitch	e	0.65 BSC		
Overall Height	A	–	–	2.00
Molded Package Thickness	A2	1.65	1.75	1.85
Standoff	A1	0.05	–	–
Overall Width	E	7.40	7.80	8.20
Molded Package Width	E1	5.00	5.30	5.60
Overall Length	D	7.90	8.20	8.50
Foot Length	L	0.55	0.75	0.95
Footprint	L1	1.25 REF		
Lead Thickness	c	0.09	–	0.25
Foot Angle	ϕ	0°	4°	8°
Lead Width	b	0.22	–	0.38

Notes:

- Pin 1 visual index feature may vary, but must be located within the hatched area.
- Dimensions D and E1 do not include mold flash or protrusions. Mold flash or protrusions shall not exceed 0.20 mm per side.
- Dimensioning and tolerancing per ASME Y14.5M.

BSC: Basic Dimension. Theoretically exact value shown without tolerances.

REF: Reference Dimension, usually without tolerance, for information purposes only.

Microchip Technology Drawing C04-132B

MCP3905A/05L/06A

24 Lead Plastic Shrink Small Outline (SS) - 5.30 mm Body [SSOP]

Note: For the most current package drawings, please see the Microchip Packaging Specification located at <http://www.microchip.com/packaging>

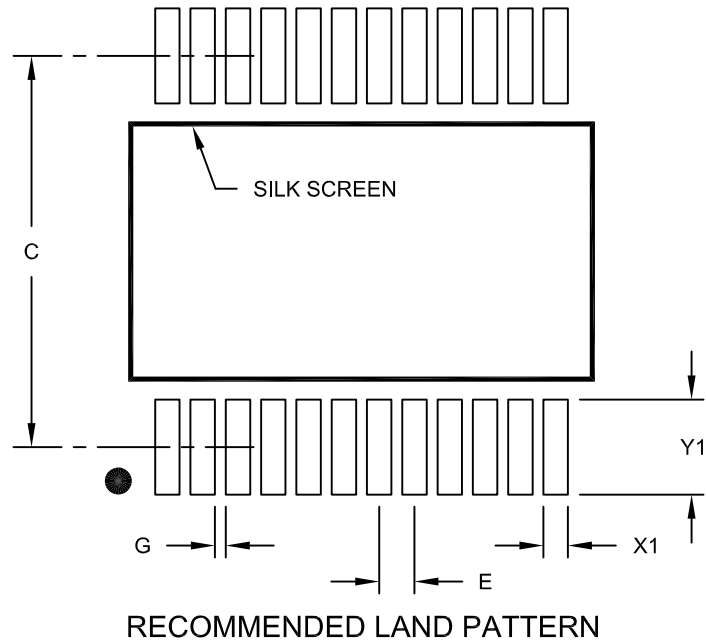

Dimension Limits	Units	MILLIMETERS		
		MIN	NOM	MAX
Contact Pitch	E	0.65 BSC		
Contact Pad Spacing	C		7.20	
Contact Pad Width (X24)	X1			0.45
Contact Pad Length (X24)	Y1			1.75
Distance Between Pads	G	0.20		

Notes:

1. Dimensioning and tolerancing per ASME Y14.5M

BSC: Basic Dimension. Theoretically exact value shown without tolerances.

Microchip Technology Drawing No. C04-2132A

MCP3905A/05L/06A

NOTES:

APPENDIX A: REVISION HISTORY

Revision B (July 2011)

The following is the list of modifications:

1. Added Extended Temperature item to the [Features](#) list.
2. Updated [Section 2.0, Typical Performance Curves](#) with new extended temperature graphics ([Figures 2-11 to 2-14](#)).
3. Updated [Section 6.0, Packaging Information](#) to show the Land Pattern drawings.
4. Updated the [Product Identification System](#) section with the Extended Temperature characteristic and examples.

Revision A (September 2006)

- Original Release of this Document.

MCP3905A/05L/06A

NOTES:

MCP3905A/05L/06A

PRODUCT IDENTIFICATION SYSTEM

To order or obtain information, e.g., on pricing or delivery, refer to the factory or the listed sales office.

<u>PART NO.</u>	<u>-X</u>	<u>/XX</u>	
Device	Temperature Range	Package	
Device:	MCP3905A: Energy Metering IC MCP3905AT: Energy Metering IC (Tape and Reel) MCP3905L: Energy Metering IC MCP3905LT: Energy Metering IC (Tape and Reel) MCP3906A: Energy Metering IC MCP3906AT: Energy Metering IC (Tape and Reel)		
Temperature Range:	E = -40°C to +125°C I = -40°C to +85°C		
Package:	SS = Plastic Shrink Small Outline (209 mil Body), 24-lead		
			Examples: a) MCP3905A-E/SS: Extended Temperature, 24LD SSOP. b) MCP3905AT-E/SS: Tape and Reel, Extended Temperature, 24LD SSOP. c) MCP3905A-I/SS: Industrial Temperature, 24LD SSOP. d) MCP3905AT-I/SS: Tape and Reel, Industrial Temperature, 24LD SSOP. a) MCP3905L-E/SS: Extended Temperature, 24LD SSOP. b) MCP3905LT-E/SS: Tape and Reel, Extended Temperature, 24LD SSOP. c) MCP3905L-I/SS: Industrial Temperature, 24LD SSOP. d) MCP3905LT-I/SS: Tape and Reel, Industrial Temperature, 24LD SSOP. a) MCP3906A-E/SS: Extended Temperature, 24LD SSOP. b) MCP3906AT-E/SS: Tape and Reel, Extended Temperature, 24LD SSOP. c) MCP3906A-I/SS: Industrial Temperature, 24LD SSOP. d) MCP3906AT-I/SS: Tape and Reel, Industrial Temperature, 24LD SSOP.

MCP3905A/05L/06A

NOTES:

Note the following details of the code protection feature on Microchip devices:

- Microchip products meet the specification contained in their particular Microchip Data Sheet.
- Microchip believes that its family of products is one of the most secure families of its kind on the market today, when used in the intended manner and under normal conditions.
- There are dishonest and possibly illegal methods used to breach the code protection feature. All of these methods, to our knowledge, require using the Microchip products in a manner outside the operating specifications contained in Microchip's Data Sheets. Most likely, the person doing so is engaged in theft of intellectual property.
- Microchip is willing to work with the customer who is concerned about the integrity of their code.
- Neither Microchip nor any other semiconductor manufacturer can guarantee the security of their code. Code protection does not mean that we are guaranteeing the product as “unbreakable.”

Code protection is constantly evolving. We at Microchip are committed to continuously improving the code protection features of our products. Attempts to break Microchip's code protection feature may be a violation of the Digital Millennium Copyright Act. If such acts allow unauthorized access to your software or other copyrighted work, you may have a right to sue for relief under that Act.

Information contained in this publication regarding device applications and the like is provided only for your convenience and may be superseded by updates. It is your responsibility to ensure that your application meets with your specifications. MICROCHIP MAKES NO REPRESENTATIONS OR WARRANTIES OF ANY KIND WHETHER EXPRESS OR IMPLIED, WRITTEN OR ORAL, STATUTORY OR OTHERWISE, RELATED TO THE INFORMATION, INCLUDING BUT NOT LIMITED TO ITS CONDITION, QUALITY, PERFORMANCE, MERCHANTABILITY OR FITNESS FOR PURPOSE. Microchip disclaims all liability arising from this information and its use. Use of Microchip devices in life support and/or safety applications is entirely at the buyer's risk, and the buyer agrees to defend, indemnify and hold harmless Microchip from any and all damages, claims, suits, or expenses resulting from such use. No licenses are conveyed, implicitly or otherwise, under any Microchip intellectual property rights.

Trademarks

The Microchip name and logo, the Microchip logo, dsPIC, KEELOQ, KEELOQ logo, MPLAB, PIC, PICmicro, PICSTART, PIC³² logo, rfPIC and UNI/O are registered trademarks of Microchip Technology Incorporated in the U.S.A. and other countries.

FilterLab, Hampshire, HI-TECH C, Linear Active Thermistor, MXDEV, MXLAB, SEEVAL and The Embedded Control Solutions Company are registered trademarks of Microchip Technology Incorporated in the U.S.A.

Analog-for-the-Digital Age, Application Maestro, chipKIT, chipKIT logo, CodeGuard, dsPICDEM, dsPICDEM.net, dsPICworks, dsSPEAK, ECAN, ECONOMONITOR, FanSense, HI-TIDE, In-Circuit Serial Programming, ICSP, Mindi, MiWi, MPASM, MPLAB Certified logo, MPLIB, MPLINK, mTouch, Omniscient Code Generation, PICC, PICC-18, PICDEM, PICDEM.net, PICKit, PICtail, REAL ICE, rfLAB, Select Mode, Total Endurance, TSHARC, UniWinDriver, WiperLock and ZENA are trademarks of Microchip Technology Incorporated in the U.S.A. and other countries.

SQTP is a service mark of Microchip Technology Incorporated in the U.S.A.

All other trademarks mentioned herein are property of their respective companies.

© 2011, Microchip Technology Incorporated, Printed in the U.S.A., All Rights Reserved.

 Printed on recycled paper.

ISBN: 978-1-61341-410-1

QUALITY MANAGEMENT SYSTEM
CERTIFIED BY DNV
== ISO/TS 16949:2009 ==

Microchip received ISO/TS-16949:2009 certification for its worldwide headquarters, design and wafer fabrication facilities in Chandler and Tempe, Arizona; Gresham, Oregon and design centers in California and India. The Company's quality system processes and procedures are for its PIC[®] MCUs and dsPIC[®] DSCs, KEELOQ[®] code hopping devices, Serial EEPROMs, microperipherals, nonvolatile memory and analog products. In addition, Microchip's quality system for the design and manufacture of development systems is ISO 9001:2000 certified.



MICROCHIP

Worldwide Sales and Service

AMERICAS

Corporate Office
2355 West Chandler Blvd.
Chandler, AZ 85224-6199
Tel: 480-792-7200
Fax: 480-792-7277
Technical Support:
<http://www.microchip.com/support>
Web Address:
www.microchip.com

Atlanta
Duluth, GA
Tel: 678-957-9614
Fax: 678-957-1455

Boston
Westborough, MA
Tel: 774-760-0087
Fax: 774-760-0088

Chicago
Itasca, IL
Tel: 630-285-0071
Fax: 630-285-0075

Cleveland
Independence, OH
Tel: 216-447-0464
Fax: 216-447-0643

Dallas
Addison, TX
Tel: 972-818-7423
Fax: 972-818-2924

Detroit
Farmington Hills, MI
Tel: 248-538-2250
Fax: 248-538-2260

Indianapolis
Noblesville, IN
Tel: 317-773-8323
Fax: 317-773-5453

Los Angeles
Mission Viejo, CA
Tel: 949-462-9523
Fax: 949-462-9608

Santa Clara
Santa Clara, CA
Tel: 408-961-6444
Fax: 408-961-6445

Toronto
Mississauga, Ontario,
Canada
Tel: 905-673-0699
Fax: 905-673-6509

ASIA/PACIFIC

Asia Pacific Office
Suites 3707-14, 37th Floor
Tower 6, The Gateway
Harbour City, Kowloon
Hong Kong
Tel: 852-2401-1200
Fax: 852-2401-3431

Australia - Sydney
Tel: 61-2-9868-6733
Fax: 61-2-9868-6755

China - Beijing
Tel: 86-10-8569-7000
Fax: 86-10-8528-2104

China - Chengdu
Tel: 86-28-8665-5511
Fax: 86-28-8665-7889

China - Chongqing
Tel: 86-23-8980-9588
Fax: 86-23-8980-9500

China - Hangzhou
Tel: 86-571-2819-3180
Fax: 86-571-2819-3189

China - Hong Kong SAR
Tel: 852-2401-1200
Fax: 852-2401-3431

China - Nanjing
Tel: 86-25-8473-2460
Fax: 86-25-8473-2470

China - Qingdao
Tel: 86-532-8502-7355
Fax: 86-532-8502-7205

China - Shanghai
Tel: 86-21-5407-5533
Fax: 86-21-5407-5066

China - Shenyang
Tel: 86-24-2334-2829
Fax: 86-24-2334-2393

China - Shenzhen
Tel: 86-755-8203-2660
Fax: 86-755-8203-1760

China - Wuhan
Tel: 86-27-5980-5300
Fax: 86-27-5980-5118

China - Xian
Tel: 86-29-8833-7252
Fax: 86-29-8833-7256

China - Xiamen
Tel: 86-592-2388138
Fax: 86-592-2388130

China - Zhuhai
Tel: 86-756-3210040
Fax: 86-756-3210049

ASIA/PACIFIC

India - Bangalore
Tel: 91-80-3090-4444
Fax: 91-80-3090-4123

India - New Delhi
Tel: 91-11-4160-8631
Fax: 91-11-4160-8632

India - Pune
Tel: 91-20-2566-1512
Fax: 91-20-2566-1513

Japan - Yokohama
Tel: 81-45-471- 6166
Fax: 81-45-471-6122

Korea - Daegu
Tel: 82-53-744-4301
Fax: 82-53-744-4302

Korea - Seoul
Tel: 82-2-554-7200
Fax: 82-2-558-5932 or
82-2-558-5934

Malaysia - Kuala Lumpur
Tel: 60-3-6201-9857
Fax: 60-3-6201-9859

Malaysia - Penang
Tel: 60-4-227-8870
Fax: 60-4-227-4068

Philippines - Manila
Tel: 63-2-634-9065
Fax: 63-2-634-9069

Singapore
Tel: 65-6334-8870
Fax: 65-6334-8850

Taiwan - Hsin Chu
Tel: 886-3-6578-300
Fax: 886-3-6578-370

Taiwan - Kaohsiung
Tel: 886-7-213-7830
Fax: 886-7-330-9305

Taiwan - Taipei
Tel: 886-2-2500-6610
Fax: 886-2-2508-0102

Thailand - Bangkok
Tel: 66-2-694-1351
Fax: 66-2-694-1350

EUROPE

Austria - Wels
Tel: 43-7242-2244-39
Fax: 43-7242-2244-393

Denmark - Copenhagen
Tel: 45-4450-2828
Fax: 45-4485-2829

France - Paris
Tel: 33-1-69-53-63-20
Fax: 33-1-69-30-90-79

Germany - Munich
Tel: 49-89-627-144-0
Fax: 49-89-627-144-44

Italy - Milan
Tel: 39-0331-742611
Fax: 39-0331-466781

Netherlands - Drunen
Tel: 31-416-690399
Fax: 31-416-690340

Spain - Madrid
Tel: 34-91-708-08-90
Fax: 34-91-708-08-91

UK - Wokingham
Tel: 44-118-921-5869
Fax: 44-118-921-5820

05/02/11



Компания «ЭлектроПласт» предлагает заключение долгосрочных отношений при поставках импортных электронных компонентов на взаимовыгодных условиях!

Наши преимущества:

- Оперативные поставки широкого спектра электронных компонентов отечественного и импортного производства напрямую от производителей и с крупнейших мировых складов;
- Поставка более 17-ти миллионов наименований электронных компонентов;
- Поставка сложных, дефицитных, либо снятых с производства позиций;
- Оперативные сроки поставки под заказ (от 5 рабочих дней);
- Экспресс доставка в любую точку России;
- Техническая поддержка проекта, помощь в подборе аналогов, поставка прототипов;
- Система менеджмента качества сертифицирована по Международному стандарту ISO 9001;
- Лицензия ФСБ на осуществление работ с использованием сведений, составляющих государственную тайну;
- Поставка специализированных компонентов (Xilinx, Altera, Analog Devices, Intersil, Interpoint, Microsemi, Aeroflex, Peregrine, Syfer, Eurofarad, Texas Instrument, Miteq, Cobham, E2V, MA-COM, Hittite, Mini-Circuits, General Dynamics и др.);

Помимо этого, одним из направлений компании «ЭлектроПласт» является направление «Источники питания». Мы предлагаем Вам помощь Конструкторского отдела:

- Подбор оптимального решения, техническое обоснование при выборе компонента;
- Подбор аналогов;
- Консультации по применению компонента;
- Поставка образцов и прототипов;
- Техническая поддержка проекта;
- Защита от снятия компонента с производства.



Как с нами связаться

Телефон: 8 (812) 309 58 32 (многоканальный)

Факс: 8 (812) 320-02-42

Электронная почта: org@eplast1.ru

Адрес: 198099, г. Санкт-Петербург, ул. Калинина, дом 2, корпус 4, литера А.