

ISSUE : October 6, 2016

TO ; \_\_\_\_\_

## S P E C I F I C A T I O N S

Product Name PHOTOCOUPLER

Model No. PC123

**【Business dealing name : PC123X\*YFZ1B】**

These specifications contain 14 pages including the cover and appendix.  
This specification sheets and attached sheets shall be both side copy.  
After confirmation of the contents, please be sure to send back     copy of the  
Specifications with approving signature on each.  
If you have any objections, please contact us before issuing purchasing order.

Accepted by:

Sharp Corporation

By : \_\_\_\_\_

Name :

Title :

Date :

By : T. Ichinose

Name : T. Ichinose,

Title : Division Manager,

Development Division. V

System Device Business Unit

Electronic Components and Devices BU

Date : Oct. 7, 2016

By : \_\_\_\_\_

Name :

Title :

Date :

Reviewed by :

Prepared by :

By : T. Okuda

Name : T. Okuda

Title : Senior Manager

Date : Oct. 7, 2016

By : H. Shoji

Name : H. Shoji

Title : Supervisor

Date : Oct. 7, 2016

1. These specification sheets include materials protected under copyright of Sharp Corporation ("Sharp"). Please handle with great care and do not reproduce or cause anyone to reproduce them without Sharp's consent.
2. When using this Sharp product, please observe the absolute maximum ratings, other conditions and instructions for use described in the specification sheets, as well as the precautions mentioned below.  
Sharp assumes no responsibility for any damages resulting from use of the product which does not comply with absolute maximum ratings, other conditions and instructions for use included in the specification sheets, and the precautions mentioned below.

(Precautions)

- (1) In making catalogue or instruction manual based on the specification sheets, please verify the validity of the catalogue or instruction manuals after assembling Sharp products in customer's products at the responsibility of customer.
- (2) This Sharp product is designed for use in the following application areas ;
  - Computers • OA equipment • Telecommunication equipment (Terminal) • Measuring equipment
  - Tooling machines • Audio visual equipment • Home appliancesIf the use of the Sharp product in the above application areas is for equipment listed in paragraphs (3) or (4), please be sure to observe the precautions given in those respective paragraphs.
- (3) Appropriate measures, such as fail-safe design and redundant design considering the safety design of the overall system and equipment, should be taken to ensure reliability and safety when Sharp product is used for equipment in responsibility of customer which demands high reliability and safety in function and precision, such as ;
  - Transportation control and safety equipment (aircraft, train, automobile etc.)
  - Traffic signals • Gas leakage sensor breakers • Rescue and security equipment
  - Other safety equipment
- (4) Sharp product is designed for consumer goods and controlled as consumer goods in production and quality. Please do not use this product for equipment which require extremely high reliability and safety in function and precision, such as ;
  - Space equipment • Telecommunication equipment (for trunk lines)
  - Nuclear power control equipment • Medical equipment
- (5) Please contact and consult with a Sharp sales representative if there are any question regarding interpretation of the above four paragraphs.

3. Disclaimer

The warranty period for Sharp product is one (1) year after shipment.  
During the period, if there are any products problem, Sharp will repair (if applicable), replace or refund.  
Except the above, both parties will discuss to cope with the problems.

The failed Sharp product after the above one (1) year period will be coped with by Sharp, provided that both parties shall discuss and determine on sharing responsibility based on the analysis results thereof subject to the above scope of warranty.

The warranty described herein is only for Sharp product itself which are purchased by or delivered to customer.  
Damages arising from Sharp product malfunction or failure shall be excepted.

Sharp will not be responsible for the Sharp product due to the malfunction or failures thereof which are caused by:

- (1) storage keep trouble during the inventory in the marketing channel.
- (2) intentional act, negligence or wrong/poor handling.
- (3) equipment which Sharp products are connected to or mounted in.
- (4) disassembling, reforming or changing Sharp products.
- (5) installation problem.
- (6) act of God or other disaster (natural disaster, fire, flood, etc.)
- (7) external factors (abnormal voltage, abnormal electromagnetic wave, fire, etc.)
- (8) special environment (factory, coastal areas, hot spring area, etc.)
- (9) phenomenon which cannot be foreseen based on the practical technologies at the time of shipment.
- (10) the factors not included in the product specification sheet.

4. Please contact and consult with a Sharp sales representative for any questions about Sharp product.

1. Application

This specification applies to the outline and characteristics of photocoupler Model No. PC123(Lead-Free Type).

2. Outline Refer to the attached sheet, page 6.

3. Ratings and characteristics Refer to the attached sheet, page 7, 8.

4. Reliability Refer to the attached sheet, page 9.

5. Outgoing inspection Refer to the attached sheet, page 10.

6. Supplement

6.1 Isolation voltage shall be measured in the following method.

- (1) Short between anode and cathode on the primary side and between collector and emitter on the secondary side.
- (2) The dielectric withstanding tester with zero-cross circuit shall be used.
- (3) The wave form of applied voltage shall be a sine wave.  
(It is recommended that the isolation voltage be measured in insulation oil.)

6.2 Packing specifications Refer to the attached sheet, page 11, 12.

6.3 Collector current (Ic) Delivery rank table ("○" mark indicates business dealing name of ordered product)

Rank at delivery	* Business dealing name	Rank mark	Ic (mA)	
	PC123XNYFZ1B	with or without	2.5 to 20.0	Test conditions  I <sub>F</sub> =5mA V <sub>CE</sub> =5V T <sub>a</sub> =25°C
	PC123X1YFZ1B	L	2.5 to 7.5	
	PC123X2YFZ1B	M	5.0 to 12.5	
	PC123X5YFZ1B	N	10.0 to 20.0	
	PC123X8YFZ1B	E	5.0 to 10.0	

6.4 The relevant models are the models approved by VDE according to DIN EN 60747-5-5(Under preparation).

Approved Model No. : PC123

VDE approved No. : Under preparation (According to the specification DIN EN 60747-5-5)

- Operating isolation voltage V<sub>IORM</sub> : 1140V (Peak)
- Transient voltage : 9000V (Peak)
- Pollution : 2
- Clearances distance (Between input and output) : 8.0mm (MIN.)
- Creep age distance (Between input and output) : 8.0mm (MIN.)
- Isolation thickness between input and output : 0.4mm (MIN.)
- Tracking-proof : CTI 175
- Safety limit values
  - Current (I<sub>si</sub>) : 200mA (Diode side)
  - Power (P<sub>si</sub>) : 300mW (Phototransistor side)
  - Temperature (T<sub>si</sub>) : 150°C

In order to keep safety electric isolation of photocoupler, please set the protective circuit to keep within safety limit values when the actual application equipment troubled.

- Indication of VDE approval "  " is printed on minimum unit package.

Isolation specification according to EN 60747-5-5

Parameter	Symbol	Condition	Rating	Unit	Remark
Class of environmental test	-	-	55/110/21	-	
Pollution	-	-	2	-	
Maximum operating isolation voltage	$V_{IORM}$ (PEAK)	-	1140	V	Refer to the Diagram 1 (3/12) Refer to the Diagram 2 (4/12)
Partial discharge test voltage (Between input and output)					
Diagram 1	$V_m$ (PEAK)	$t_m=10s, qc<5pC$	1830	V	
Diagram 2		$t_{st}=1s, qc<5pC$	2140	V	
Maximum over-voltage	$V_{ini,a}$ (PEAK)	$t_{ni}=60s$	9000	V	
Safety maximum ratings					Refer to the Fig. 1, 2 (4/12)
1) Case temperature	$T_{si}$	$I_f=0, P_c=0$	150	°C	
2) Input current	$I_{si}$	$P_c=0$	200	mA	
3) Electric power (Output or Total power dissipation)	$P_{si}$	-	300	mW	
Isolation resistance (Test voltage between input and output ; DC500V)	$R_{ISO}$	$T_{amb}=T_{si}$	MIN.10 <sup>9</sup>	Ω	
		$T_{amb}=100°C$	MIN.10 <sup>11</sup>		
		$T_{amb}=25°C$	MIN.10 <sup>12</sup>		

Precautions in performing isolation test

- (1) Partial discharge test methods shall be the ones according to the specifications of EN 60747-5-5
- (2) Please don't carry out isolation test ( $V_{iso}$ ) over  $V_{ini,a}$ .

This product deteriorates isolation characteristics by partial discharge due to applying high voltage (ex.  $V_{ini,a}$ ).  
And there is possibility that partial discharge occurs in operating isolation voltage. ( $V_{IORM}$ ).

Method of Diagram 1: Breakdown test (Apply to type test and sampling test)

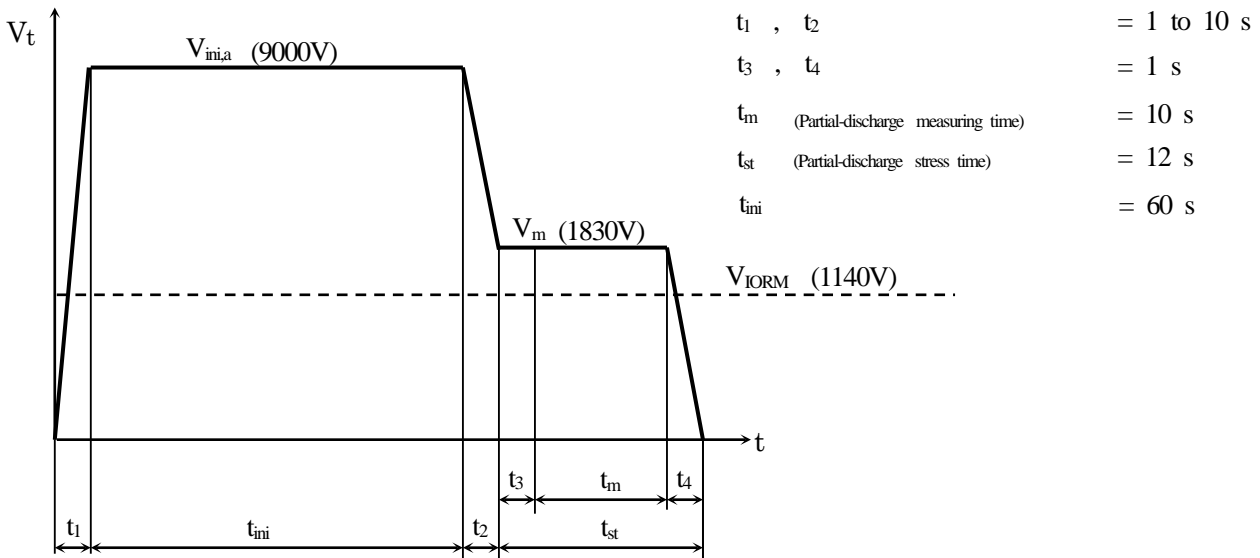

Method of Diagram 2: Non breakdown test (Apply to all device test)

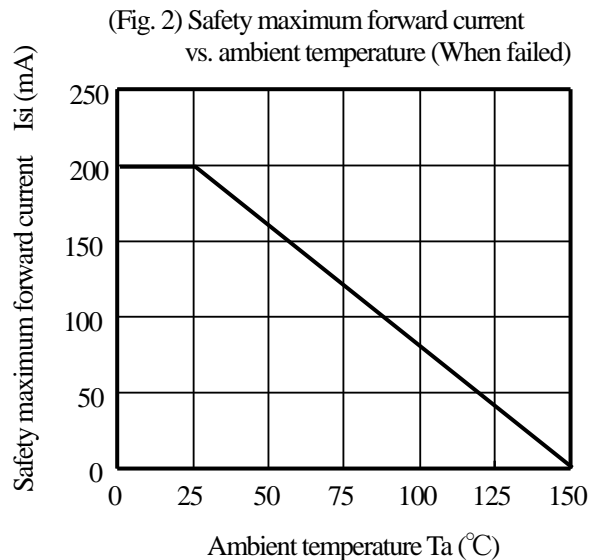
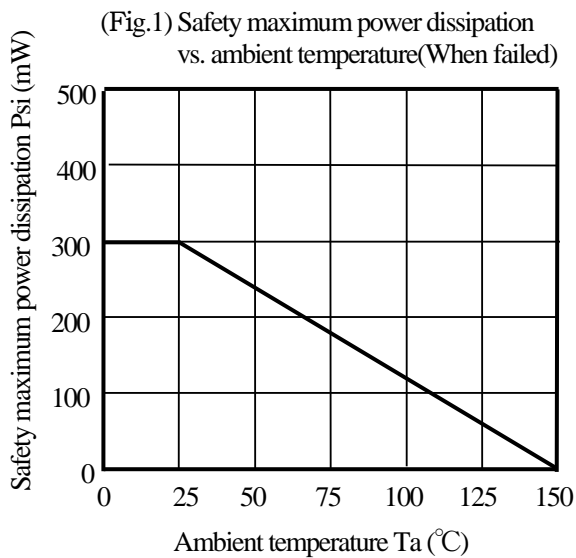
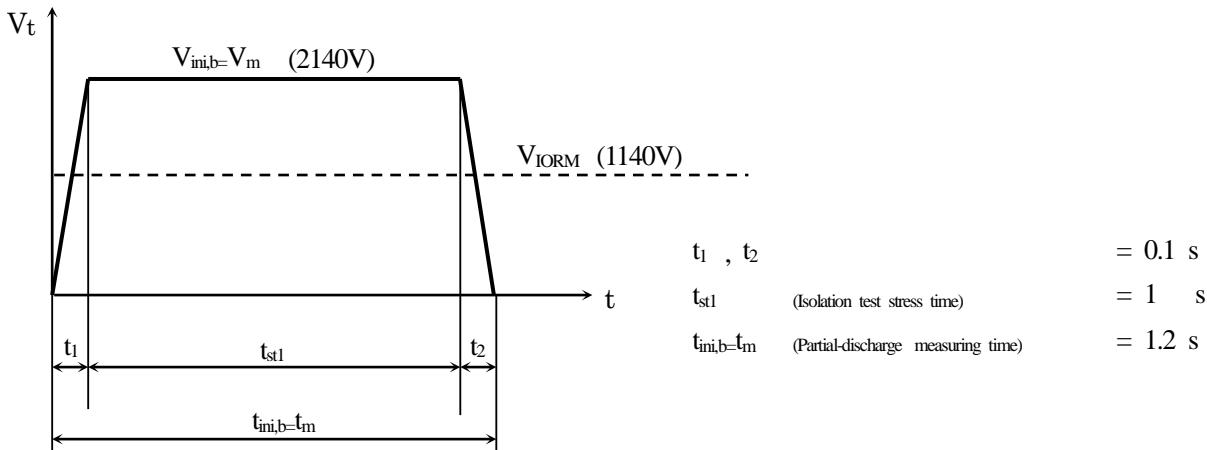

6.5 This Model is approved by UL. (Under preparation).  
 Approved Model No. : PC123  
 UL file No. : E64380

6.6 This Model is approved by CSA. (Under preparation).  
 Approved Model No. : PC123  
 CSA approved mark " " shall be indicated on minimum unit package.

6.7 This product is approved by BSI , SEMKO, DEMKO, NEMKO and FIMKO. (Under preparation).

6.8 This product is not designed against irradiation.  
 This product is assembled with electrical input and output.  
 This product incorporates non-coherent light emitting diode.

6.9 ODS materials  
 This product shall not contain the following materials.  
 Also, the following materials shall not be used in the production process for this product.  
 Materials for ODS : CFCs, Halon, Carbon tetrachloride, 1.1.1-Trichloroethane (Methyl chloroform)

6.10 Specified brominated flame retardants

Specified brominated flame retardants (PBB and PBDE) are not used in this device at all

6.11 Compliance with each regulation

- (1) The RoHS directive(2011/65/EU)

This product complies with the RoHS directive(2011/65/EU) .

Object substances: mercury, lead, cadmium, hexavalent chromium, polybrominated biphenyls (PBB) and polybrominated diphenyl ethers (PBDE)

- (2) Content of six substances specified in Management Methods for Control of Pollution Caused by Electronic Information Products Regulation (Chinese : 电子信息产品污染控制管理办法).

Marking Styles for the Names and Contents of the Hazardous Substances

Category	Hazardous Substances					
	Lead (Pb)	Mercury (Hg)	Cadmium (Cd)	Hexavalent chromium (Cr <sup>6+</sup> )	Polybrominated biphenyls (PBB)	Polybrominated diphenyl ethers (PBDE)
Photocoupler	○	○	○	○	○	○

This table is prepared in accordance with the provisions of SJ/T 11364.

○ : Indicates that said hazardous substance contained in all of the homogeneous materials for this part is below the limit requirement of GB/T 26572

7. Notes

Precautions for photocouplers : Attachment-1

# REFERENCE

## 2. Outline

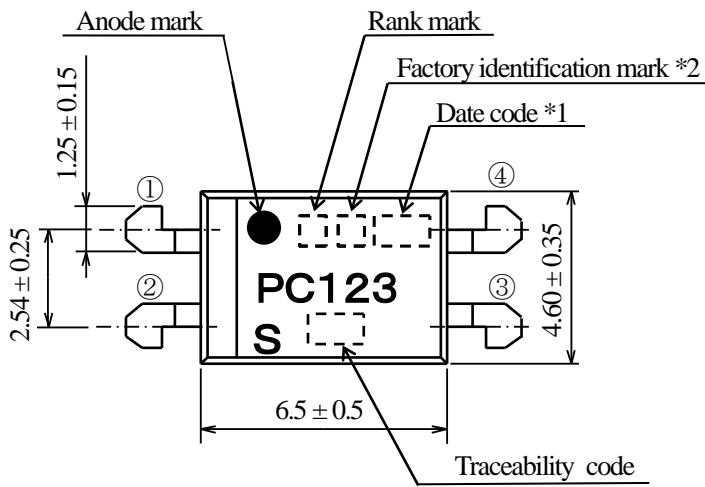

Pin-Number and internal connection diagram

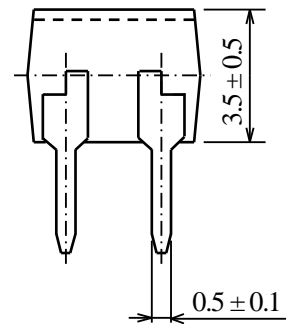
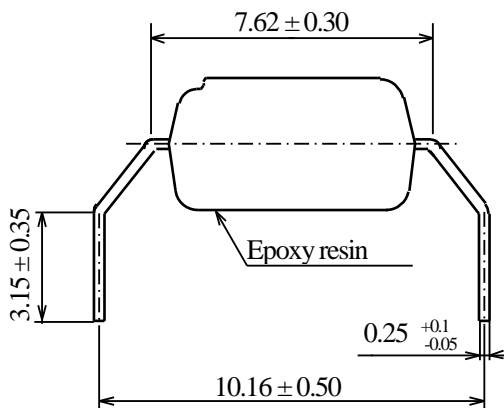
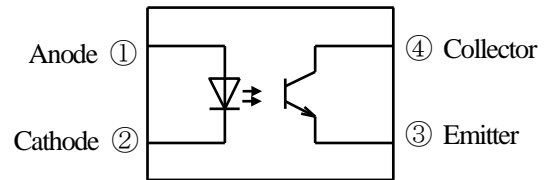

\*1) Date code : 3 digit indication according to production year and week

\*2) Factory identification mark apply to the below

K : Kyushu Denshi Co.,Ltd. (Japan products)

Pin material : Copper Alloy

Pin finish : SnBi plating (Bi : 1~4%)

Mark : laser marking

Product mass : Approx. 0.23 g

UNIT : 1/1 mm	
Name	PC123 Outline Dimensions (Business dealing name : PC123X*YFZ1B)

### 3. Ratings and characteristics

#### 3.1 Absolute maximum ratings

Ta=25°C

Parameter		Symbol	Rating	Unit
Input	Forward current *1	I <sub>F</sub>	50	mA
	Peak forward current *2	I <sub>FM</sub>	1	A
	Reverse voltage	V <sub>R</sub>	6	V
	Power dissipation *1	P	70	mW
Output	Collector-emitter voltage	V <sub>CEO</sub>	80	V
	Emitter-collector voltage	V <sub>ECO</sub>	6	V
	Collector current	I <sub>c</sub>	50	mA
	Collector power dissipation *1	P <sub>c</sub>	150	mW
Total power dissipation *1		P <sub>tot</sub>	200	mW
Operating temperature		T <sub>opr</sub>	-30 to +100	°C
Storage temperature		T <sub>stg</sub>	-55 to +125	°C
Isolation voltage *3		V <sub>iso(rms)</sub>	5	kV
Soldering temperature *4		T <sub>sol</sub>	270	°C

#### 3.2 Electro-optical characteristics

Ta=25°C

Parameter		Symbol	Condition	MIN.	TYP.	MAX.	Unit
Input	Forward voltage	V <sub>F</sub>	I <sub>F</sub> =20mA	-	1.2	1.4	V
	Reverse current	I <sub>R</sub>	V <sub>R</sub> =4V	-	-	10	μA
	Terminal capacitance	C <sub>t</sub>	V=0, f=1kHz	-	30	250	pF
Output	Dark current	I <sub>CEO</sub>	V <sub>CE</sub> =50V, I <sub>F</sub> =0	-	-	100	nA
	Collector-emitter breakdown voltage	BV <sub>CEO</sub>	I <sub>c</sub> =0.1mA, I <sub>F</sub> =0	80	-	-	V
	Emitter-Collector breakdown voltage	BV <sub>ECO</sub>	I <sub>E</sub> =10 μA, I <sub>F</sub> =0	6	-	-	V
Transfer characteristics	Collector current	I <sub>c</sub>	I <sub>F</sub> =5mA, V <sub>CE</sub> =5V	2.5	-	20	mA
	Collector-emitter saturation voltage	V <sub>CE(sat)</sub>	I <sub>F</sub> =20mA, I <sub>c</sub> =1mA	-	0.1	0.2	V
	Isolation resistance	R <sub>ISO</sub>	DC500V 40 to 60%RH	5 × 10 <sup>10</sup>	10 <sup>11</sup>	-	Ω
	Floating capacitance	C <sub>f</sub>	V=0, f=1MHz	-	0.6	1.0	pF
	Cut-off frequency	f <sub>c</sub>	V <sub>CE</sub> =5V, I <sub>c</sub> =2mA R <sub>L</sub> =100 Ω, -3dB	-	80	-	kHz
	Response time (Rise)	t <sub>r</sub>	V <sub>CE</sub> =2V, I <sub>c</sub> =2mA R <sub>L</sub> =100 Ω	-	4	18	μs
Response time (Fall)	t <sub>f</sub>	-		3	18	μs	

\*1 The derating factors of absolute maximum ratings due to ambient temperature are shown in Fig. 3 to 6.

\*2 Pulse width ≤ 100 μs, Duty ratio : 0.001 (Refer to Fig. 7)

\*3 AC for 1 min, 40 to 60%RH

\*4 For 10s



(Fig.3) Forward current vs. ambient temperature

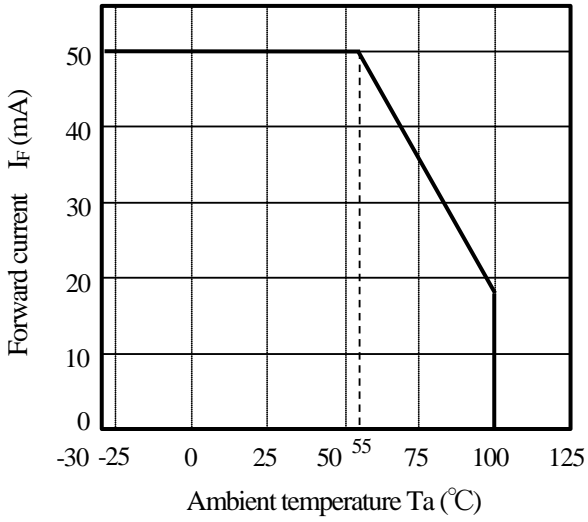

(Fig.4) Diode power dissipation vs. ambient temperature

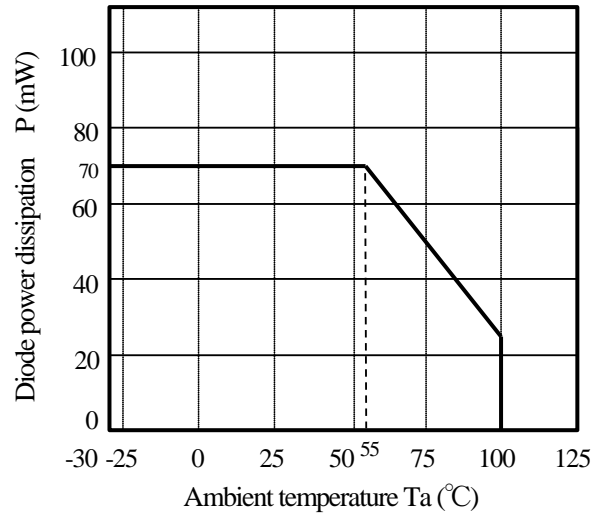

(Fig.5) Collector power dissipation vs. ambient temperature

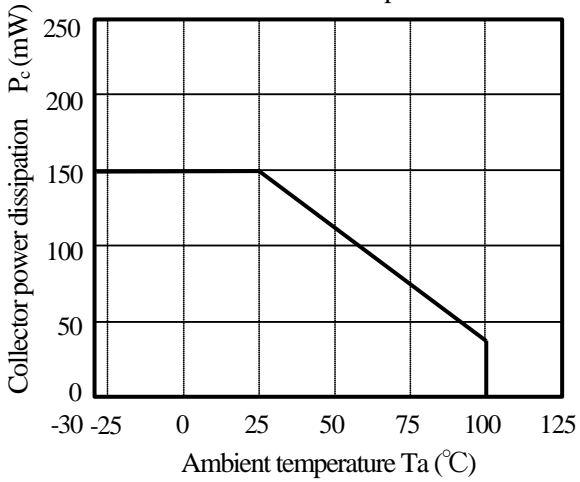

(Fig.6) Total power dissipation vs. ambient temperature

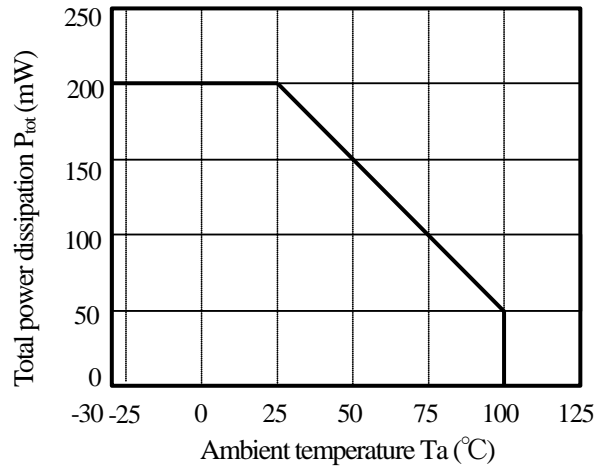

(Fig.7) Forward current vs. duty ratio

Pulse width  $\leq 100\mu s$

$T_a = 25^\circ C$

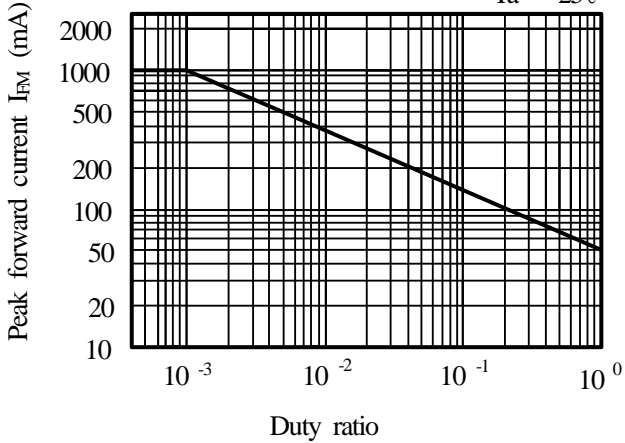

#### 4. Reliability

The reliability of products shall satisfy items listed below.

Confidence level : 90%

LTPD : 10 or 20

Test Items	Condition	Failure Judgment Criteria	Samples (n) Defective (C)
Solderability	245±3°C, 5s	*2	n=11, C=0
Soldering heat	(Flow soldering) 270°C, 10 s	$V_F > U \times 1.2$ $I_R > U \times 2$ $I_{CEO} > U \times 2$ $I_C < L \times 0.7$ $V_{CE(sat)} > U \times 1.2$  U: Upper specification limit L: Lower specification limit	n=11, C=0
	(Soldering by hand) 400°C, 3 s		n=11, C=0
Terminal strength (Tension)	Weight: 5N 5 s/each terminal		n=11, C=0
Terminal strength (Bending) *3	Weight: 2.5N 2 times/each terminal		n=11, C=0
Mechanical shock	15km/s <sup>2</sup> , 0.5ms 3 times/±X, ±Y, ±Z direction		n=11, C=0
Variable frequency vibration	100 to 2000 to 100Hz/4 min 200m/s <sup>2</sup> 4 times/X, Y, Z direction		n=11, C=0
Temperature cycling	1 cycle -55 °C to +125°C (30 min) (30 min) 20 cycles test		n=22, C=0
High temp. and high Humidity storage	+85°C, 85%RH, 1000h		n=22, C=0
High temp. storage	+125°C, 1000h		n=22, C=0
Low temp. storage	-55°C, 1000h		n=22, C=0
Operation life	I <sub>F</sub> =50mA, P <sub>tot</sub> =200mW T <sub>a</sub> =25°C, 1000h	n=22, C=0	

\*1 Test method, conforms to EIAJ ED 4701.

\*2 The product whose not-soldered area is more than 5% for all of the dipped area, and/or whose pinholes or voids are concentrated on one place shall be judged defect.

\*3 Terminal bending direction is shown below.

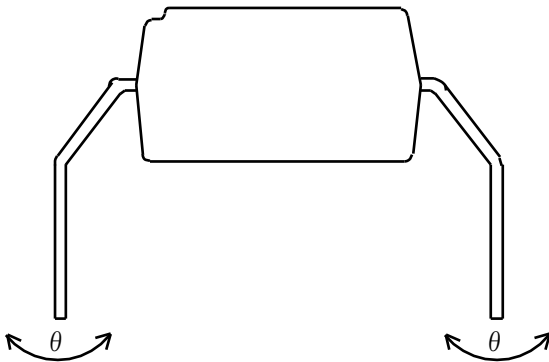

5. Outgoing inspection

5.1 Inspection items

(1) Electrical characteristics

$V_F, I_R, I_{CEO}, V_{CE(sat)}, I_C, R_{ISO}, V_{iso}$

(2) Appearance

5.2 Sampling method and Inspection level

LTPD sampling inspection

confidence level : 90%

Defect	Inspection item	LTPD (%)
Major defect	Electrical characteristics(faiure) Marking (Unreadable) Lead form (Deformation)	3
Minor defect	Appearance defect except the above mentioned.	50

## 6.2 Packing specification

### 6.2.1 Package materials

No.	Name	Materials	Purposes
①	Sleeve	HIPS or ABS with preventing static electricity	Products packaged
②	Stopper	Enhanced polymer	Products fixed
③	Inner bag	Polyethylene	Packaging bag for sleeve with product
④	Sealing tape	Cellophane	Lid of inner bag
⑤	Label	Paper	Model No.,(Business dealing name),Lot No., Quantity, Country of origin , Company name and Inspection date specified
⑥	Packing case	Paper	Inner bag packaged
⑦	Cushioning material	Polyethylene	Inner bag fixed
⑧	Sealing tape	Cellophane	Lid of packingcase
⑨	Label	Paper	Model No.,(Business dealing name),Lot No., Quantity, Country of origin , Company name and Inspection date specified

### 6.2.2 Package method

- (1) MAX. 100pcs. of products shall be packaged in a sleeve ① and both of sleeve edges shall be fixed by stoppers ②.
- (2) MAX. 25 sleeves (Product : 2500pcs.) above shall be packaged in inner case ③. and sealed by tape ④.
- (3) The label ⑤ shall be put on the top of the inner bag.
- (4) Max 2 bags(product : 5000pcs) above shall be packaged in packing case ⑥, and put a cushioning material ⑦ inside.
- (5) The label ⑨ shall be put on the side of the packing case.
- (6) Case shall be closed with the lid and enclosed with kraft tape ⑧.

### 6.2.3 Sleeve package ① outline dimensions

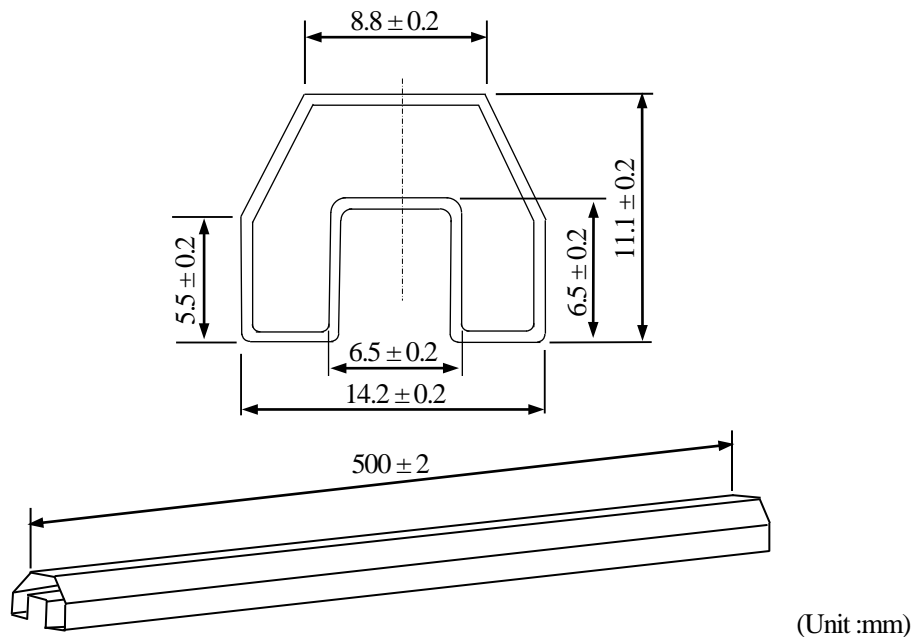

- Note
- 1) Thickness :  $0.5 \pm 0.2$ mm
  - 2) Process with applying antistatic treatment.
  - 3) Unless otherwise specified tolerances shall be  $\pm 0.5$ mm.  
(However except for deformation due to the stopper in sleeve.)

# REFERENCE

## 6.2.4 Packing case outline dimensions

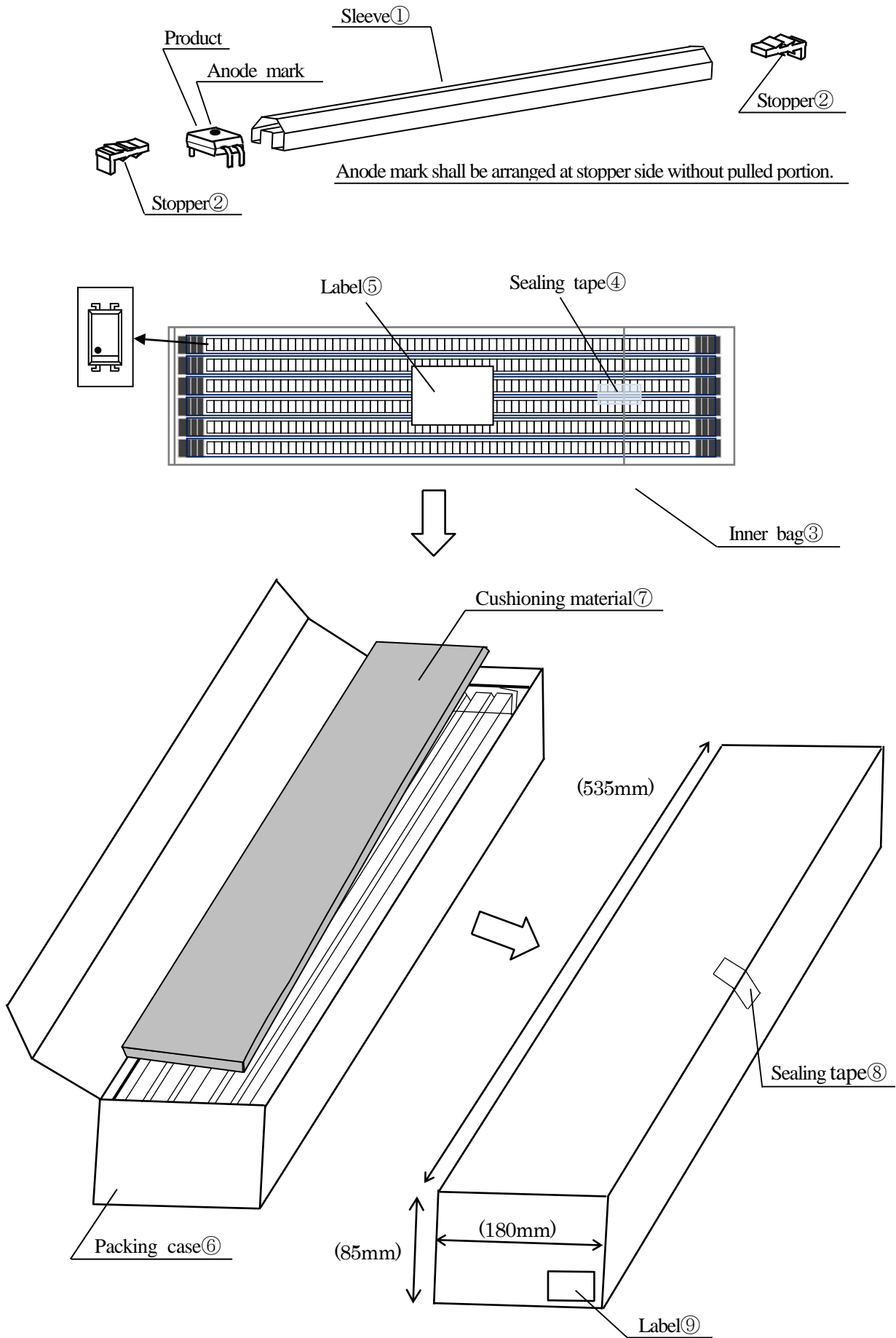

Regular packing mass : Approx. 2kg

( ) : Reference dimensions

Precautions for Photocouplers

1 Cleaning

- (1) Solvent cleaning : Solvent temperature 45°C or less  
Immersion for 3 min or less
- (2) Ultrasonic cleaning : The effect to device by ultrasonic cleaning differs by cleaning bath size, ultrasonic power output, cleaning time, PCB size or device mounting condition etc. Please test it in actual using condition and confirm that any defect doesn't occur before starting the ultrasonic cleaning.
- (3) Applicable solvent : Ethyl alcohol, Methyl alcohol, Isopropyl alcohol  
When the other solvent is used, there are cases that the packaging resin is eroded.  
Please use the other solvent after thorough confirmation is performed in actual using condition.

2. Circuit design

- 2.1 The LED used in the Photocoupler generally decreases the light emission power by operation.  
In case of long operation time, please design the circuit in consideration of the degradation of the light emission power of the LED. (50%/5years)
- 2.2 There are cases that the deviation of the CTR and the degradation of the relative light emission power of the LED increase when the setting value of  $I_F < 1\text{mA}$ . Please design the circuit in consideration of this point.

3. Precautions for Soldering

- (1) In the case of flow soldering (Whole dipping is possible)  
It is recommended that flow soldering should be at 270°C or less for 10 s or less  
(Pre-heating : 100 to 150°C, 30 to 80s). (2 times or less)
- (2) In the case of hand soldering  
What is done on the following condition is recommended.(2 times or less)  
Soldering iron temperature : 400°C or less  
Time : 3s or less
- (3) Other precautions  
Depending on equipment and soldering conditions (temperature, Using solder etc.), the effect to the device and the PCB is different.  
Please confirm that there is no problem on the actual use conditions in advance.

# Mouser Electronics

Authorized Distributor

Click to View Pricing, Inventory, Delivery & Lifecycle Information:

[Sharp Microelectronics:](#)

[PC123X2YFZ1B](#)



Компания «ЭлектроПласт» предлагает заключение долгосрочных отношений при поставках импортных электронных компонентов на взаимовыгодных условиях!

Наши преимущества:

- Оперативные поставки широкого спектра электронных компонентов отечественного и импортного производства напрямую от производителей и с крупнейших мировых складов;
- Поставка более 17-ти миллионов наименований электронных компонентов;
- Поставка сложных, дефицитных, либо снятых с производства позиций;
- Оперативные сроки поставки под заказ (от 5 рабочих дней);
- Экспресс доставка в любую точку России;
- Техническая поддержка проекта, помощь в подборе аналогов, поставка прототипов;
- Система менеджмента качества сертифицирована по Международному стандарту ISO 9001;
- Лицензия ФСБ на осуществление работ с использованием сведений, составляющих государственную тайну;
- Поставка специализированных компонентов (Xilinx, Altera, Analog Devices, Intersil, Interpoint, Microsemi, Aeroflex, Peregrine, Syfer, Eurofarad, Texas Instrument, Miteq, Cobham, E2V, MA-COM, Hittite, Mini-Circuits, General Dynamics и др.);

Помимо этого, одним из направлений компании «ЭлектроПласт» является направление «Источники питания». Мы предлагаем Вам помощь Конструкторского отдела:

- Подбор оптимального решения, техническое обоснование при выборе компонента;
- Подбор аналогов;
- Консультации по применению компонента;
- Поставка образцов и прототипов;
- Техническая поддержка проекта;
- Защита от снятия компонента с производства.



#### Как с нами связаться

**Телефон:** 8 (812) 309 58 32 (многоканальный)

**Факс:** 8 (812) 320-02-42

**Электронная почта:** [org@eplast1.ru](mailto:org@eplast1.ru)

**Адрес:** 198099, г. Санкт-Петербург, ул. Калинина, дом 2, корпус 4, литера А.