

# Surface Mount Trench MOS Barrier Schottky Rectifier

**DO-214AB (SMC)**

**RoHS**  
 COMPLIANT  
 HALOGEN  
**FREE**
**FEATURES**

- Low profile package
- Ideal for automated placement
- Trench MOS Schottky technology
- Low power losses, high efficiency
- Low forward voltage drop
- Meets MSL level 1, per J-STD-020, LF maximum peak of 260 °C
- Material categorization: For definitions of compliance please see [www.vishay.com/doc?99912](http://www.vishay.com/doc?99912)

**TYPICAL APPLICATIONS**

For use in high frequency converters, freewheeling diodes, DC/DC converters and polarity protection applications.

**MECHANICAL DATA**

**Case:** DO-214AB (SMC)

Molding compound meets UL 94 V-0 flammability rating  
 Base P/N-M3 - halogen-free and RoHS-compliant, commercial grade

**Terminals:** Matte tin plated leads, solderable per J-STD-002 and JESD 22-B102

M3 suffix meets JESD 201 class 2 whisker test

**Polarity:** Color band denotes the cathode end

PRIMARY CHARACTERISTICS	
$I_{F(AV)}$	8.0 A
$V_{RRM}$	45 V
$I_{FSM}$	140 A
$V_F$ at $I_F = 8.0$ A ( $T_A = 125$ °C)	0.39 V
$T_J$ max.	150 °C
Package	DO-214AB (SMC)
Diode variation	Single die

MAXIMUM RATINGS ( $T_A = 25$ °C unless otherwise noted)			
PARAMETER	SYMBOL	VSSC8L45	UNIT
Device marking code		8L45	
Maximum repetitive peak reverse voltage	$V_{RRM}$	45	V
Maximum DC forward current	$I_F^{(1)}$	8.0	A
	$I_F^{(2)}$	4.9	
Peak forward surge current 10 ms single half sine-wave superimposed on rated load	$I_{FSM}$	140	A
Operating junction and storage temperature range	$T_J, T_{STG}$	-40 to +150	°C

**Notes**

(1) Units mounted on 3 cm x 3 cm Aluminum, 2 oz. PCB

(2) Free air, mounted on recommended copper pad area



ELECTRICAL CHARACTERISTICS (T <sub>A</sub> = 25 °C unless otherwise noted)						
PARAMETER	TEST CONDITIONS	SYMBOL	TYP.	MAX.	UNIT	
Instantaneous forward voltage	I <sub>F</sub> = 4.0 A	T <sub>A</sub> = 25 °C	V <sub>F</sub> <sup>(1)</sup>	0.42	-	V
	I <sub>F</sub> = 8.0 A			0.48	0.56	
	I <sub>F</sub> = 4.0 A	T <sub>A</sub> = 125 °C		0.32	-	
	I <sub>F</sub> = 8.0 A			0.39	0.48	
Reverse current	V <sub>R</sub> = 45 V	T <sub>A</sub> = 25 °C	-	1.85	mA	
		T <sub>A</sub> = 125 °C	13	40		
Typical junction capacitance	4.0 V, 1 MHz	C <sub>J</sub>	1216	-	pF	

**Notes**

- (1) Pulse test: 300 μs pulse width, 1 % duty cycle
- (2) Pulse test: Pulse width ≤ 5 ms

THERMAL CHARACTERISTICS (T <sub>A</sub> = 25 °C unless otherwise noted)			
PARAMETER	SYMBOL	VSSC8L45	UNIT
Typical thermal resistance	R <sub>θJA</sub> <sup>(1)</sup>	70	°C/W
	R <sub>θJM</sub> <sup>(2)</sup>	8	

**Notes**

- (1) Free air, mounted on recommended PCB 2 oz. pad area; thermal resistance R<sub>θJA</sub> - junction to ambient
- (2) Units mounted on 3 cm x 3 cm Aluminum, 2 oz. pad area; thermal resistance R<sub>θJM</sub> - junction to mount

ORDERING INFORMATION (Example)				
PREFERRED P/N	UNIT WEIGHT (g)	PREFERRED PACKAGE CODE	BASE QUANTITY	DELIVERY MODE
VSSC8L45-M3/57T	0.235	57T	850	7" diameter plastic tape and reel
VSSC8L45-M3/9AT	0.235	9AT	3500	13" diameter plastic tape and reel

**RATINGS AND CHARACTERISTICS CURVES (T<sub>A</sub> = 25 °C unless otherwise noted)**

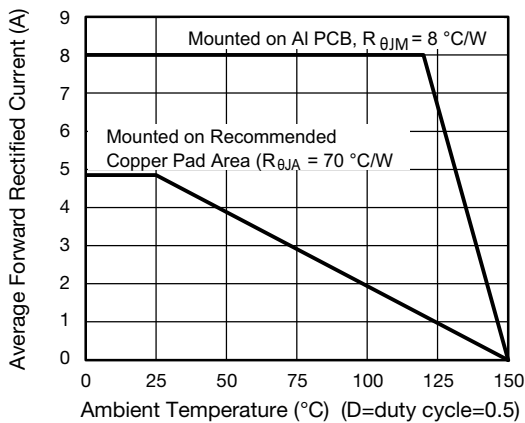

Fig. 1 - Maximum Forward Current Derating Curve

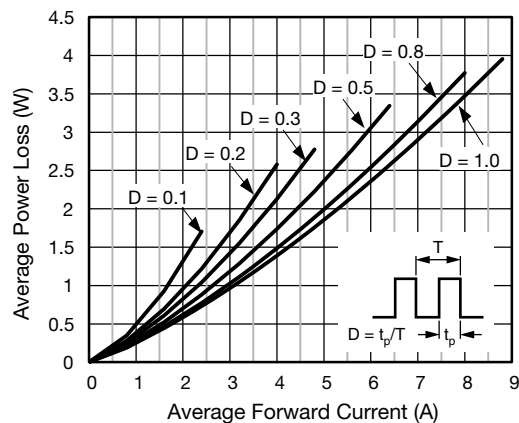

Fig. 2 - Forward Power Loss Characteristics

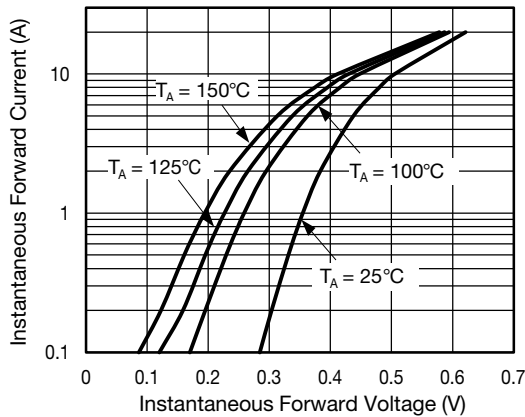

Fig. 3 - Typical Instantaneous Forward Characteristics

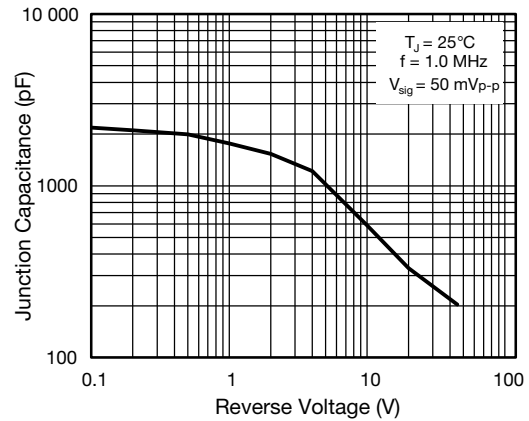

Fig. 5 - Typical Junction Capacitance

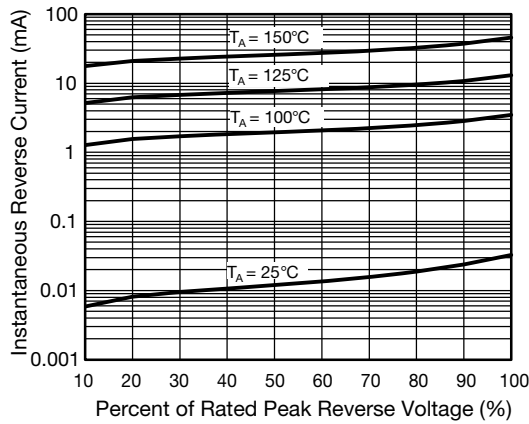

Fig. 4 - Typical Reverse Characteristics

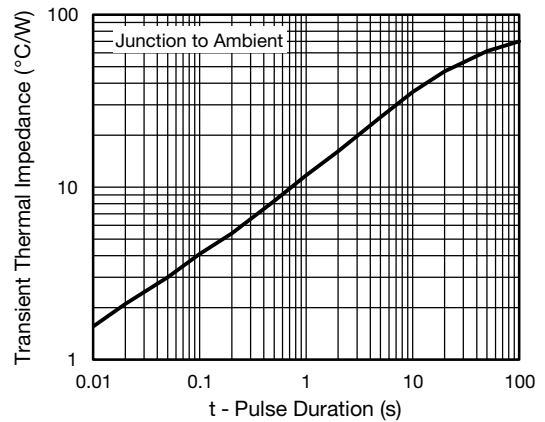
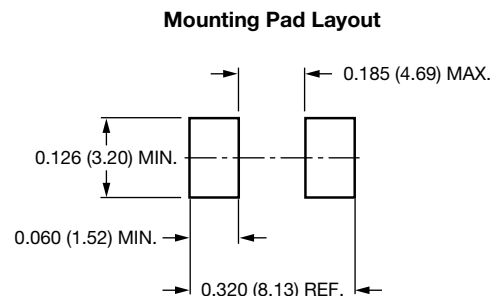
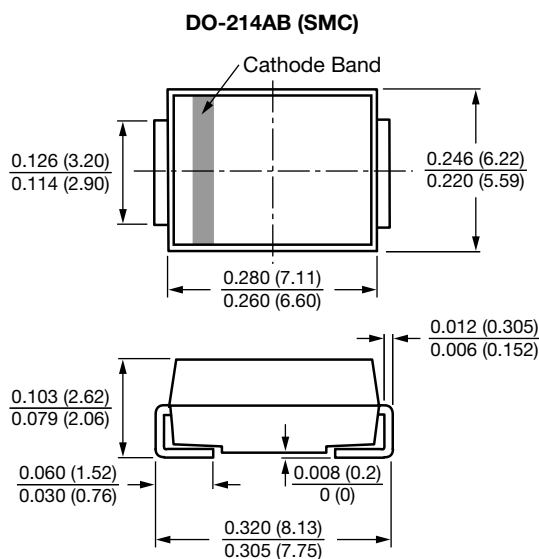

Fig. 6 - Typical Transient Thermal Impedance

**PACKAGE OUTLINE DIMENSIONS** in inches (millimeters)





## **Disclaimer**

ALL PRODUCT, PRODUCT SPECIFICATIONS AND DATA ARE SUBJECT TO CHANGE WITHOUT NOTICE TO IMPROVE RELIABILITY, FUNCTION OR DESIGN OR OTHERWISE.

Vishay Intertechnology, Inc., its affiliates, agents, and employees, and all persons acting on its or their behalf (collectively, "Vishay"), disclaim any and all liability for any errors, inaccuracies or incompleteness contained in any datasheet or in any other disclosure relating to any product.

Vishay makes no warranty, representation or guarantee regarding the suitability of the products for any particular purpose or the continuing production of any product. To the maximum extent permitted by applicable law, Vishay disclaims (i) any and all liability arising out of the application or use of any product, (ii) any and all liability, including without limitation special, consequential or incidental damages, and (iii) any and all implied warranties, including warranties of fitness for particular purpose, non-infringement and merchantability.

Statements regarding the suitability of products for certain types of applications are based on Vishay's knowledge of typical requirements that are often placed on Vishay products in generic applications. Such statements are not binding statements about the suitability of products for a particular application. It is the customer's responsibility to validate that a particular product with the properties described in the product specification is suitable for use in a particular application. Parameters provided in datasheets and / or specifications may vary in different applications and performance may vary over time. All operating parameters, including typical parameters, must be validated for each customer application by the customer's technical experts. Product specifications do not expand or otherwise modify Vishay's terms and conditions of purchase, including but not limited to the warranty expressed therein.

Except as expressly indicated in writing, Vishay products are not designed for use in medical, life-saving, or life-sustaining applications or for any other application in which the failure of the Vishay product could result in personal injury or death. Customers using or selling Vishay products not expressly indicated for use in such applications do so at their own risk. Please contact authorized Vishay personnel to obtain written terms and conditions regarding products designed for such applications.

No license, express or implied, by estoppel or otherwise, to any intellectual property rights is granted by this document or by any conduct of Vishay. Product names and markings noted herein may be trademarks of their respective owners.



Компания «ЭлектроПласт» предлагает заключение долгосрочных отношений при поставках импортных электронных компонентов на взаимовыгодных условиях!

Наши преимущества:

- Оперативные поставки широкого спектра электронных компонентов отечественного и импортного производства напрямую от производителей и с крупнейших мировых складов;
- Поставка более 17-ти миллионов наименований электронных компонентов;
- Поставка сложных, дефицитных, либо снятых с производства позиций;
- Оперативные сроки поставки под заказ (от 5 рабочих дней);
- Экспресс доставка в любую точку России;
- Техническая поддержка проекта, помощь в подборе аналогов, поставка прототипов;
- Система менеджмента качества сертифицирована по Международному стандарту ISO 9001;
- Лицензия ФСБ на осуществление работ с использованием сведений, составляющих государственную тайну;
- Поставка специализированных компонентов (Xilinx, Altera, Analog Devices, Intersil, Interpoint, Microsemi, Aeroflex, Peregrine, Syfer, Eurofarad, Texas Instrument, Miteq, Cobham, E2V, MA-COM, Hittite, Mini-Circuits, General Dynamics и др.);

Помимо этого, одним из направлений компании «ЭлектроПласт» является направление «Источники питания». Мы предлагаем Вам помощь Конструкторского отдела:

- Подбор оптимального решения, техническое обоснование при выборе компонента;
- Подбор аналогов;
- Консультации по применению компонента;
- Поставка образцов и прототипов;
- Техническая поддержка проекта;
- Защита от снятия компонента с производства.



#### Как с нами связаться

**Телефон:** 8 (812) 309 58 32 (многоканальный)

**Факс:** 8 (812) 320-02-42

**Электронная почта:** [org@eplast1.ru](mailto:org@eplast1.ru)

**Адрес:** 198099, г. Санкт-Петербург, ул. Калинина, дом 2, корпус 4, литера А.