

**Slide Switches, Instrumentation Grade**

SEE PAGE B20 FOR PRODUCT SPECIFICATIONS

**B**  
MSS Series

4P3T



MSS4300R

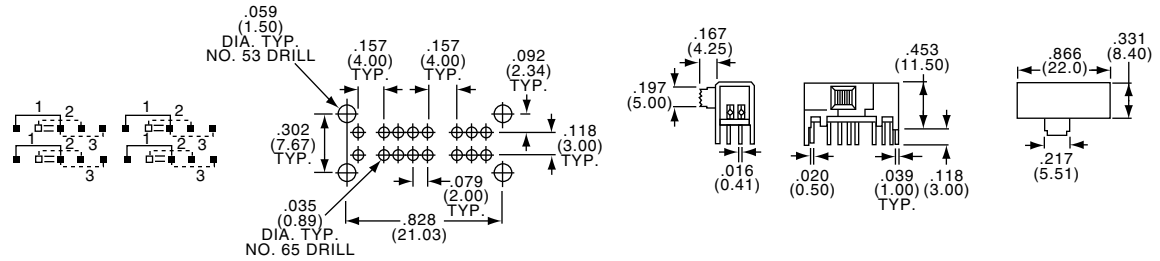

Tyco Electronics	Alcoswitch	Plating
7-1437576-7	MSS4300R	Silver
7-1437576-8	MSS4300RG	Gold

4P3T



MSS4350R

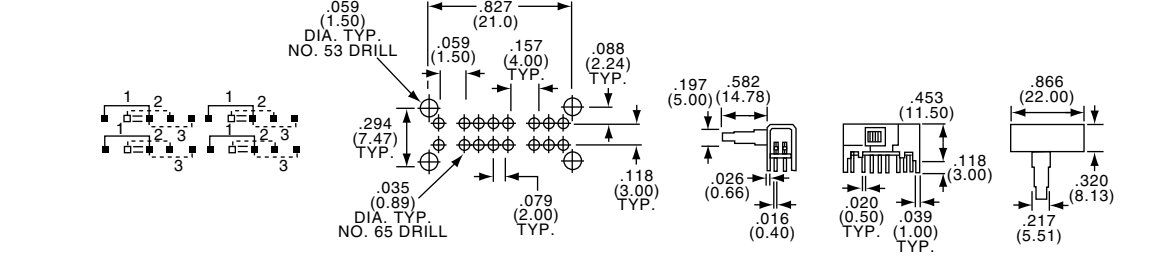

Tyco Electronics	Alcoswitch	Plating
8-1437576-0	MSS4350R	Silver
8-1437576-1	MSS4350RG	Gold

6PDT



MSS6200

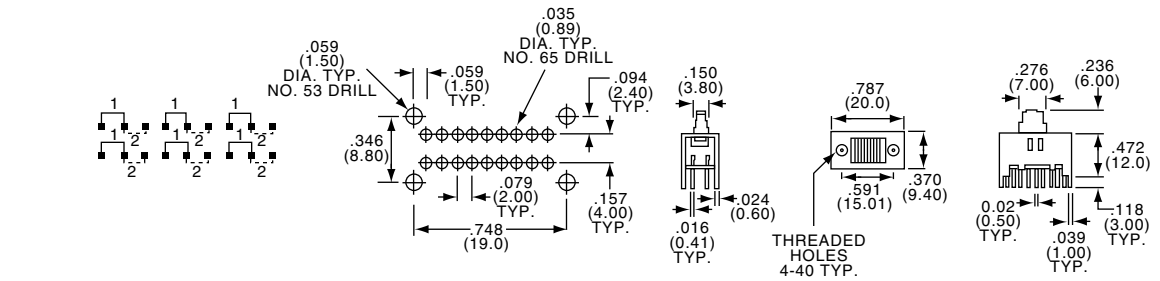

Tyco Electronics	Alcoswitch	Plating
8-1437576-8	MSS6200	Silver
8-1437576-9	MSS6200G	Gold

**Slide Switches, Instrumentation Grade**

SEE PAGE B20 FOR PRODUCT SPECIFICATIONS

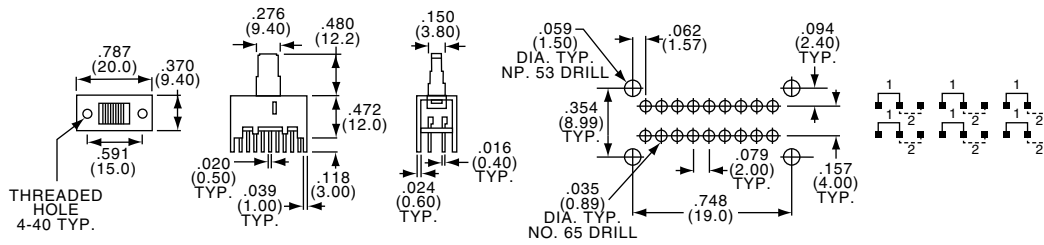

6PDT



MSS6250

Tyco Electronics	Alcoswitch	Plating
9-1437576-0	MSS6250	Silver

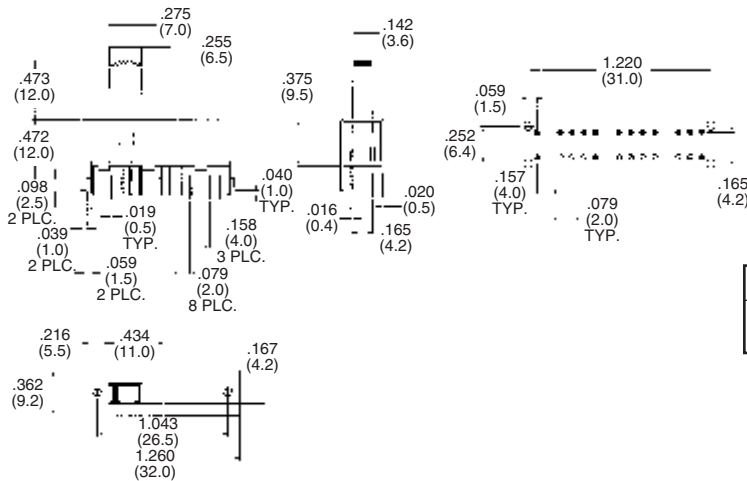

Tyco Electronics	Alcoswitch	Plating
9-1437576-3	MSS6350	Silver
—	MSS6350G	Gold

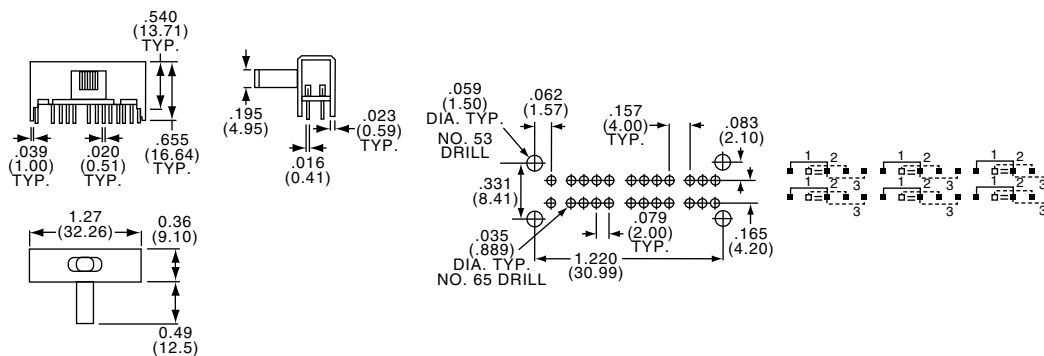

6P3T



MSS6350R

Tyco Electronics	Alcoswitch	Plating
9-1437576-4	MSS6350R	Silver
—	MSS6350RG	Gold



**Slide Switches, Instrumentation Grade**

SEE PAGE B26 FOR PRODUCT SPECIFICATIONS

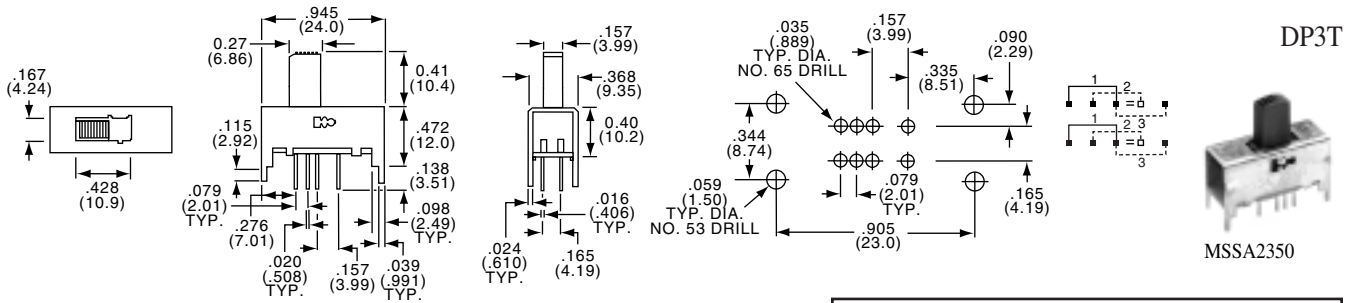

MSSA2350

Tyco Electronics	Alcoswitch	Plating	Mounting Style
5-1437580-3	MSSA2350	Silver	Upright
5-1437580-4	MSSA2350G	Gold	Upright

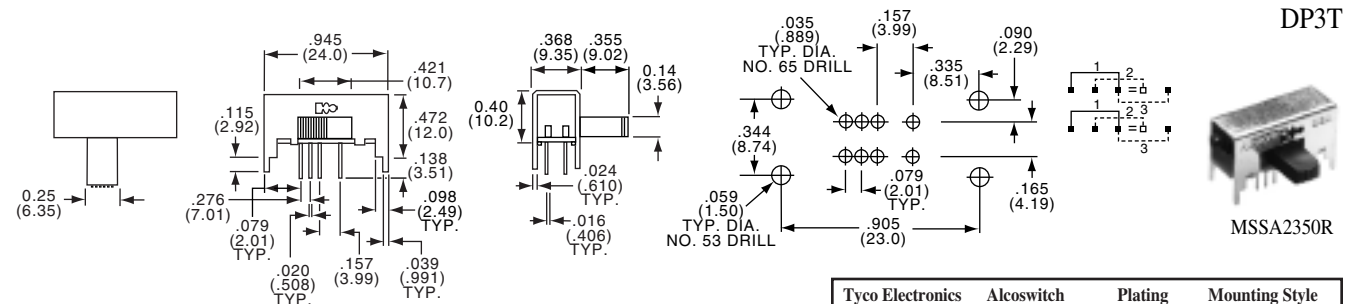

MSSA2350R

Tyco Electronics	Alcoswitch	Plating	Mounting Style
5-1437580-5	MSSA2350R	Silver	Rt. Angle
5-1437580-6	MSSA2350RG	Gold	Rt. Angle

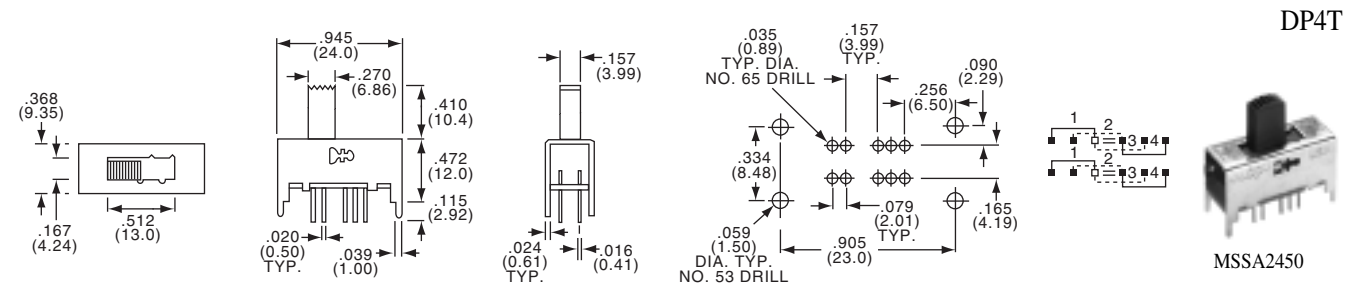

MSSA2450

Tyco Electronics	Alcoswitch	Plating	Mounting Style
5-1437580-7	MSSA2450	Silver	Upright
5-1437580-8	MSSA2450G	Gold	Upright

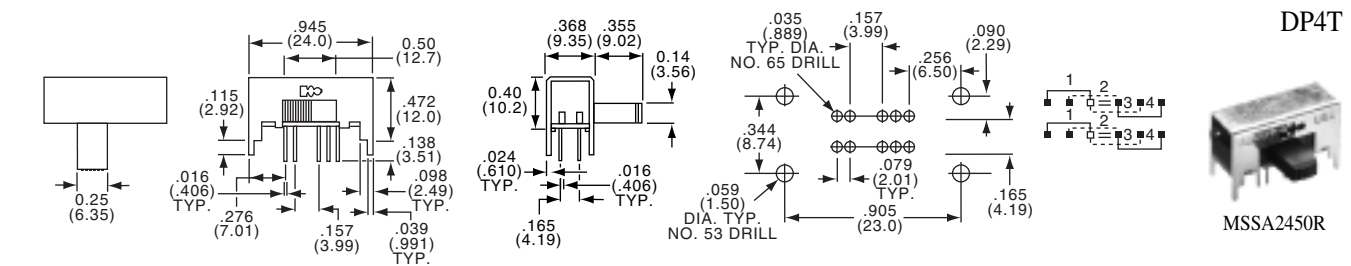

MSSA2450R

Tyco Electronics	Alcoswitch	Plating	Mounting Style
5-1437580-9	MSSA2450R	Silver	Rt. Angle
6-1437580-0	MSSA2450RG	Gold	Rt. Angle

**Slide Switches, Instrumentation Grade**

SEE PAGE B26 FOR PRODUCT SPECIFICATIONS

3P3T



MSSA3350

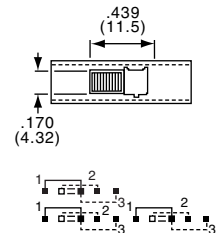
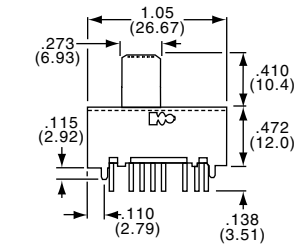
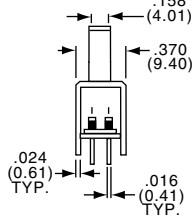
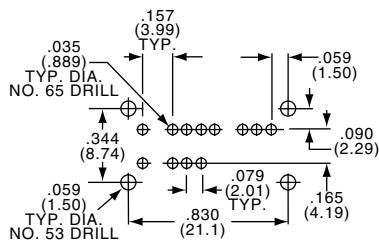

Tyco Electronics	Alcoswitch	Plating	Mounting Style
6-1437580-1	MSSA3350	Silver	Upright
6-1437580-2	MSSA3350G	Gold	Upright

3P3T



MSSA3350R

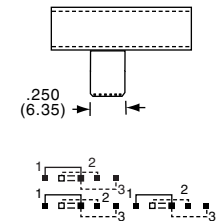
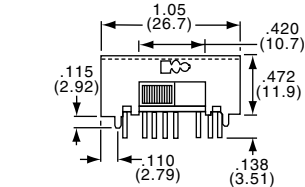
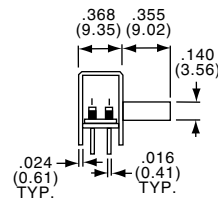
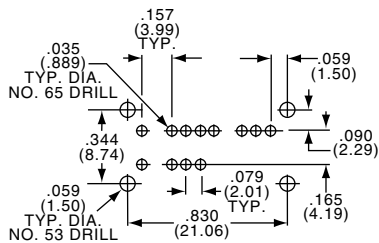

Tyco Electronics	Alcoswitch	Plating	Mounting Style
6-1437580-3	MSSA3350R	Silver	Rt. Angle
6-1437580-4	MSSA3350RG	Gold	Rt. Angle

3P4T



MSSA3450

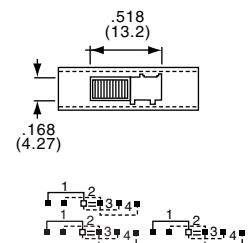
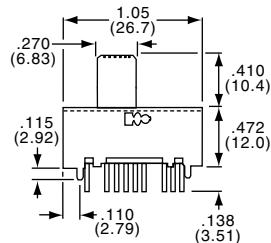
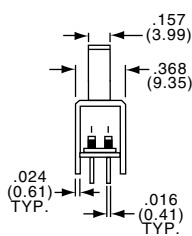
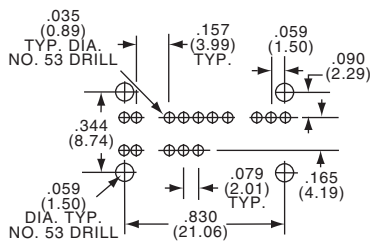

Tyco Electronics	Alcoswitch	Plating	Mounting Style
6-1437580-5	MSSA3450	Silver	Upright
6-1437580-6	MSSA3450G	Gold	Upright

3P4T



MSSA3450R

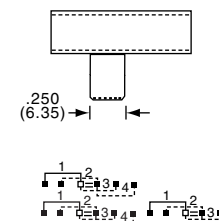
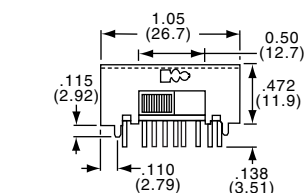
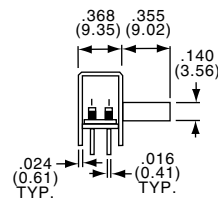
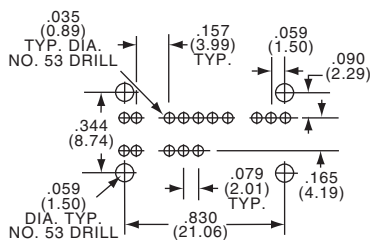

Tyco Electronics	Alcoswitch	Plating	Mounting Style
6-1437580-7	MSSA3450R	Silver	Rt. Angle
6-1437580-8	MSSA3450RG	Gold	Rt. Angle

**Slide Switches, Instrumentation Grade**

SEE PAGE B26 FOR PRODUCT SPECIFICATIONS

4P3T

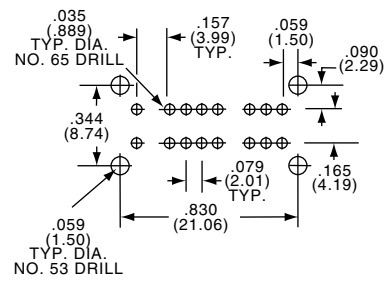
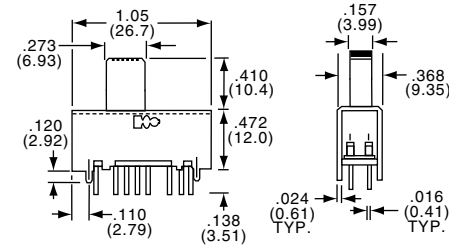
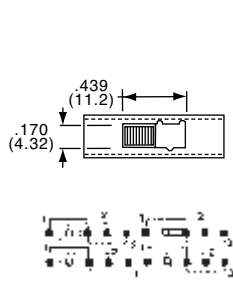

MSSA4350

Tyco Electronics	Alcoswitch	Plating	Mounting Style
6-1437580-9	MSSA4350	Silver	Upright
7-1437580-0	MSSA4350G	Gold	Upright

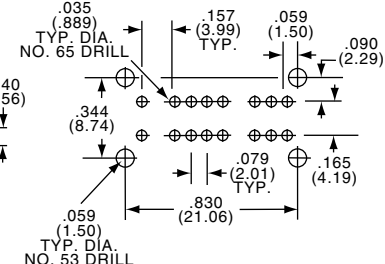
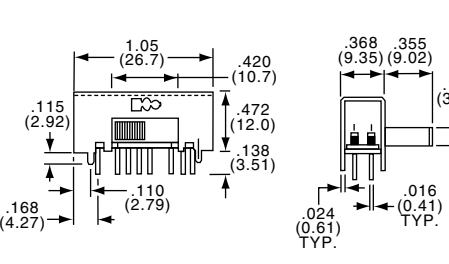
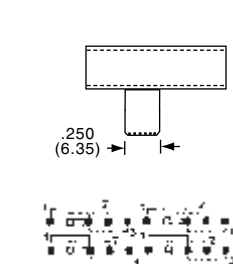

MSSA4350R

Tyco Electronics	Alcoswitch	Plating	Mounting Style
7-1437580-1	MSSA4350R	Silver	Rt. Angle
7-1437580-2	MSSA4350RG	Gold	Rt. Angle

4P3T

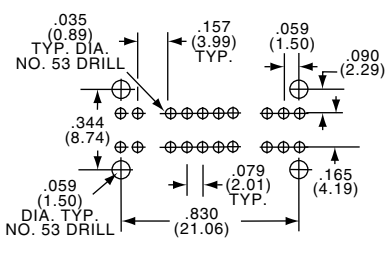
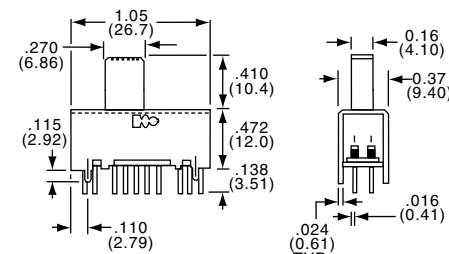
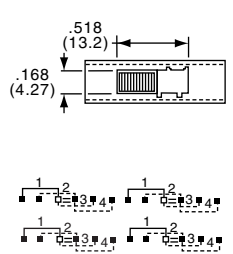

MSSA4450

Tyco Electronics	Alcoswitch	Plating	Mounting Style
7-1437580-3	MSSA4450	Silver	Upright
7-1437580-4	MSSA4450G	Gold	Upright

4P4T

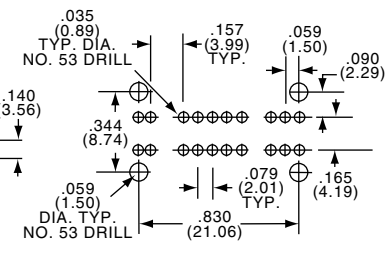
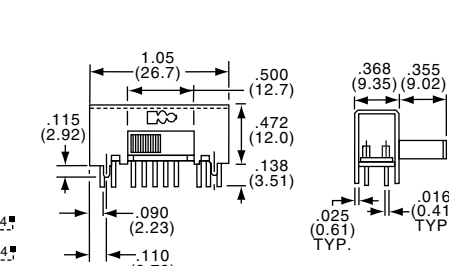
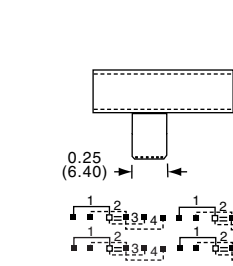

MSSA4450R

Tyco Electronics	Alcoswitch	Plating	Mounting Style
7-1437580-5	MSSA4450R	Silver	Rt. Angle
7-1437580-6	MSSA4450RG	Gold	Rt. Angle

4P4T





Компания «ЭлектроПласт» предлагает заключение долгосрочных отношений при поставках импортных электронных компонентов на взаимовыгодных условиях!

Наши преимущества:

- Оперативные поставки широкого спектра электронных компонентов отечественного и импортного производства напрямую от производителей и с крупнейших мировых складов;
- Поставка более 17-ти миллионов наименований электронных компонентов;
- Поставка сложных, дефицитных, либо снятых с производства позиций;
- Оперативные сроки поставки под заказ (от 5 рабочих дней);
- Экспресс доставка в любую точку России;
- Техническая поддержка проекта, помощь в подборе аналогов, поставка прототипов;
- Система менеджмента качества сертифицирована по Международному стандарту ISO 9001;
- Лицензия ФСБ на осуществление работ с использованием сведений, составляющих государственную тайну;
- Поставка специализированных компонентов (Xilinx, Altera, Analog Devices, Intersil, Interpoint, Microsemi, Aeroflex, Peregrine, Syfer, Eurofarad, Texas Instrument, Miteq, Cobham, E2V, MA-COM, Hittite, Mini-Circuits, General Dynamics и др.);

Помимо этого, одним из направлений компании «ЭлектроПласт» является направление «Источники питания». Мы предлагаем Вам помощь Конструкторского отдела:

- Подбор оптимального решения, техническое обоснование при выборе компонента;
- Подбор аналогов;
- Консультации по применению компонента;
- Поставка образцов и прототипов;
- Техническая поддержка проекта;
- Защита от снятия компонента с производства.



#### Как с нами связаться

**Телефон:** 8 (812) 309 58 32 (многоканальный)

**Факс:** 8 (812) 320-02-42

**Электронная почта:** [org@eplast1.ru](mailto:org@eplast1.ru)

**Адрес:** 198099, г. Санкт-Петербург, ул. Калинина, дом 2, корпус 4, литера А.