

MAX9092/MAX9093/ MAX9094/MAX9095

General-Purpose, Low-Voltage, Dual/Quad, Tiny Pack Comparators

General Description

The MAX9092/MAX9093/MAX9094/MAX9095 comparators are pin-for-pin compatible replacements for the LMX393/LMX393H/LMX339/LMX339H, respectively. The MAX9093/MAX9095 have the added benefit of internal hysteresis to provide noise immunity, preventing output oscillations even with slow-moving input signals.

Advantages of the ICs include low supply voltage, small package, and low cost. They also offer a wide supply voltage range, wide operating temperature range, competitive CMRR and PSRR, response time characteristics, input offset, low noise, output saturation voltage, input bias current, and RF immunity.

The ICs are available in both 8-pin SOT23/ μ MAX[®] and 14-pin TSSOP/SO packages.

Applications

- Mobile Communications
- Notebooks and PDAs
- Battery-Powered Electronics
- General-Purpose Portable Devices
- General-Purpose Low-Voltage Applications

Features

- Guaranteed +1.8V to +5.5V Performance
- -40°C to +125°C Automotive Temperature Range
- S Low Supply Current (65 μ A/Channel at $V_{DD} = +5.0V$)
- Input Common-Mode Voltage Range Includes Ground
- No Phase Reversal for Overdriven Inputs
- Low Output Saturation Voltage (120mV)
- Internal 2mV Hysteresis (MAX9093/MAX9095)
- Fast 100ns Propagation Delay
- Open-Drain Outputs
- 8-Pin SOT23/ μ MAX and 14-Pin TSSOP/SO Packages

[Ordering Information](#) appears at end of data sheet.

μ MAX is a registered trademark of Maxim Integrated Products, Inc.

Absolute Maximum Ratings

Supply Voltage (V_{DD} to V_{SS}).....	-0.3V to +6V	TSSOP (derate 10mW/°C above +70°C)	796mW
All Other Pins except OUT_.....	($V_{SS} - 0.3V$) to ($V_{DD} + 0.3V$)	SO (derate 11.9mW/°C above +70°C)	952mW
OUT_.....	($V_{SS} - 0.3$) to 6V	Operating Temperature Range.....	-40°C to +125°C
Differential Input Voltage (IN_+ , IN_-).....	$\pm 3.6V$	Junction Temperature.....	+150°C
Continuous Power Dissipation (Multilayer Board)($T_A = +70^\circ C$)		Storage Temperature Range.....	-65°C to +150°C
SOT23 (derate 5.1mW/°C above +70°C).....	408.2mW	Lead Temperature (soldering, 10s)	+300°C
μ MAX (derate 4.8mW/°C above +70°C)	387.8mW	Soldering Temperature (reflow)	+260°C

Stresses beyond those listed under "Absolute Maximum Ratings" may cause permanent damage to the device. These are stress ratings only, and functional operation of the device at these or any other conditions beyond those indicated in the operational sections of the specifications is not implied. Exposure to absolute maximum rating conditions for extended periods may affect device reliability.

Package Thermal Characteristics (Note 1)

SOT23	Junction-to-Ambient Thermal Resistance (θ_{JA}).....	196°C/W	TSSOP	Junction-to-Ambient Thermal Resistance (θ_{JA}).....	100.4°C/W
	Junction-to-Case Thermal Resistance (θ_{JC}).....	70°C/W		Junction-to-Case Thermal Resistance (θ_{JC}).....	30°C/W
μ MAX	Junction-to-Ambient Thermal Resistance (θ_{JA}).....	206.3°C/W	SO	Junction-to-Ambient Thermal Resistance (θ_{JA}).....	84°C/W
	Junction-to-Case Thermal Resistance (θ_{JC}).....	42°C/W		Junction-to-Case Thermal Resistance (θ_{JC}).....	34°C/W

Note 1: Package thermal resistances were obtained using the method described in JEDEC specification JESD51-7, using a four-layer board. For detailed information on package thermal considerations, refer to www.maximintegrated.com/thermal-tutorial.

DC Electrical Characteristics—2.7V Operation

($V_{DD} = 2.7V$, $V_{SS} = 0V$, $V_{CM} = 0V$, $R_L = 5.1k\Omega$ connected to V_{DD} , typical values are at $T_A = +25^\circ C$, unless otherwise noted. **Boldface** limits apply at the defined temperature extremes.) (Note 2)

PARAMETER	SYMBOL	CONDITIONS	MIN	TYP	MAX	UNITS
Input Offset Voltage	V_{OS}			0.4	7	mV
Input Voltage Hysteresis	V_{HYST}	MAX9093/MAX9095		2		mV
Input Offset Voltage Average Temperature Drift	TCV_{OS}			1.5		$\mu V/^\circ C$
Input Bias Current	I_B	$T_A = +25^\circ C$		± 0.0003	± 250	nA
		$T_A = -40^\circ C$ to $+85^\circ C$			± 400	
		$T_A = -40^\circ C$ to $+125^\circ C$			± 400	
Input Offset Current	I_{OS}	$T_A = +25^\circ C$		± 0.0003	± 50	nA
		$T_A = -40^\circ C$ to $+85^\circ C$			± 150	
		$T_A = -40^\circ C$ to $+125^\circ C$			± 150	
Input Voltage Range	V_{CM}			-0.1		V
				2		
Voltage Gain	A_V	MAX9092/MAX9094		500		V/mV
Output Saturation Voltage	V_{SAT}	$I_{SINK} \leq 1mA$		25		mV
Output Sink Current	I_{OUT}	$V_{OUT} \leq 1.5V$	5	16		mA
Supply Current	I_S	MAX9092/MAX9093 (both comparators)		100	180	μA
		MAX9094/MAX9095 (all four comparators)		220	360	
Output Leakage Current		$T_A = +25^\circ C$		0.005		μA
		$T_A = -40^\circ C$ to $+85^\circ C$			1	
		$T_A = -40^\circ C$ to $+125^\circ C$			2	

AC Electrical Characteristics—2.7V Operation

($V_{DD} = 2.7V$, $V_{SS} = 0V$, $V_{CM} = 0V$, $R_L = 5.1k\Omega$ connected to V_{DD} , typical values are at $T_A = +25^\circ C$, unless otherwise noted. **Boldface** limits apply at the defined temperature extremes.) (Note 2)

PARAMETER	SYMBOL	CONDITIONS	MIN	TYP	MAX	UNITS
Propagation Delay Output High to Low (Note 3)	t_{PHL}	Input overdrive = 10mV		70		ns
		Input overdrive = 100mV		50		
Propagation Delay Output Low to High (Note 3)	t_{PLH}	Input overdrive = 10mV		115		ns
		Input overdrive = 100mV		100		

DC Electrical Characteristics—5.0V Operation

($V_{DD} = 5V$, $V_{SS} = 0V$, $V_{CM} = 0V$, $R_L = 5.1k\Omega$ connected to V_{DD} , typical values are at $T_A = +25^\circ C$, unless otherwise noted. **Boldface** limits apply at the defined temperature extremes.) (Note 2)

PARAMETER	SYMBOL	CONDITIONS	MIN	TYP	MAX	UNITS	
Input Offset Voltage	V_{OS}	$T_A = +25^\circ C$		0.4	7	mV	
		$T_A = -40^\circ C$ to $+85^\circ C$			9		
		$T_A = -40^\circ C$ to $+125^\circ C$			9		
Input Voltage Hysteresis		MAX9093/MAX9095		2		mV	
Input Offset Voltage Average Temperature Drift	TCV_{OS}			1.5		$\mu V/^\circ C$	
Input Bias Current	I_B	$T_A = +25^\circ C$		± 0.027	± 250	nA	
		$T_A = -40^\circ C$ to $+85^\circ C$			± 400		
		$T_A = -40^\circ C$ to $+125^\circ C$			± 400		
Input Offset Current	I_{OS}	$T_A = +25^\circ C$		± 0.007	± 50	nA	
		$T_A = -40^\circ C$ to $+85^\circ C$			± 150		
		$T_A = -40^\circ C$ to $+125^\circ C$			± 150		
Input Voltage Range	V_{CM}			-0.1		V	
				4.2			
Voltage Gain (Note 4)	A_V	MAX9092/MAX9094	20	500		V/mV	
Output Saturation Voltage	V_{SAT}	$I_{SINK} \leq 4mA$	$T_A = +25^\circ C$	120	400	mV	
			$T_A = -40^\circ C$ to $+85^\circ C$				700
			$T_A = -40^\circ C$ to $+125^\circ C$				700
Output Sink Current	I_{OUT}	$V_{OUT} \leq 1.5V$	10	35		mA	
Supply Current (Note 5)	I_S	MAX9092/ MAX9093 (both comparators)	$T_A = +25^\circ C$	130	200	μA	
			$T_A = -40^\circ C$ to $+85^\circ C$				250
			$T_A = -40^\circ C$ to $+125^\circ C$				300
		MAX9094/ MAX9095 (all four comparators)	$T_A = +25^\circ C$	250	400	μA	
			$T_A = -40^\circ C$ to $+85^\circ C$				500
			$T_A = -40^\circ C$ to $+125^\circ C$				500
Output Leakage Current		$T_A = +25^\circ C$		0.005		μA	
		$T_A = -40^\circ C$ to $+85^\circ C$			1		
		$T_A = -40^\circ C$ to $+125^\circ C$			2		

AC Electrical Characteristics—5.0V Operation

($V_{DD} = 5V$, $V_{SS} = 0V$, $V_{CM} = 0V$, $R_L = 5.1k\Omega$ connected to V_{DD} , typical values are at $T_A = +25^\circ C$, unless otherwise noted. **Boldface** limits apply at the defined temperature extremes.) (Note 2)

PARAMETER	SYMBOL	CONDITIONS	MIN	TYP	MAX	UNITS
Propagation Delay Output High to Low (Note 3)	t_{PHL}	Input overdrive = 10mV		70		ns
		Input overdrive = 100mV		50		
Propagation Delay Output Low to High (Note 3)	t_{PLH}	Input overdrive = 10mV		110		ns
		Input overdrive = 100mV		100		

DC Electrical Characteristics—1.8V Operation

($V_{DD} = 1.8V$, $V_{SS} = 0V$, $V_{CM} = 0V$, $R_L = 5.1k\Omega$ connected to V_{DD} , typical values are at $T_A = +25^\circ C$, unless otherwise noted. **Boldface** limits apply at the defined temperature extremes.) (Note 2)

PARAMETER	SYMBOL	CONDITIONS	MIN	TYP	MAX	UNITS
Input Offset Voltage	V_{OS}			0.4	5	mV
Input Voltage Hysteresis		MAX9093/MAX9095		2		mV
Input Offset Voltage Average Temperature Drift	TCV_{OS}			1.5		$\mu V/^\circ C$
Input Bias Current	I_B			0.0016		nA
Input Offset Current	I_{OS}			0.0003		nA
Input Voltage Range	V_{CM}			-0.1		V
				1		
Output Saturation Voltage	V_{SAT}	$I_{SINK} \leq 1mA$		56		mV
Power-Supply Rejection Ratio	PSRR	$V_{DD} = 1.8V$ to 5.5V	60	90		dB
Output Sink Current	I_{OUT}	$V_{OUT} \leq 1.5V$		6.4		mA
Supply Current (Note 5)	I_S	MAX9092/MAX9093 (both comparators)		120	170	μA
		MAX9094/MAX9095 (all four comparators)		210	340	
Output Leakage Current				0.001		μA

AC Electrical Characteristics—1.8V Operation

($V_{DD} = 1.8V$, $V_{SS} = 0V$, $V_{CM} = 0V$, $R_L = 5.1k\Omega$ connected to V_{DD} , typical values are at $T_A = +25^\circ C$, unless otherwise noted. **Boldface** limits apply at the defined temperature extremes.) (Note 2)

PARAMETER	SYMBOL	CONDITIONS	MIN	TYP	MAX	UNITS
Propagation Delay Output High to Low (Note 3)	t_{PHL}	Input overdrive = 10mV		70		ns
		Input overdrive = 100mV		60		
Propagation Delay Output Low to High (Note 3)	t_{PLH}	Input overdrive = 10mV		120		ns
		Input overdrive = 100mV		110		

Note 2: All devices are production tested at $T_A = +25^\circ C$, unless otherwise noted. All temperature limits are guaranteed by design.

Note 3: Input overdrive is the overdrive voltage beyond the offset and hysteresis-determined trip points.

Note 4: Guaranteed by design.

Note 5: Supply current when output is high.

Typical Operating Characteristics

($V_{DD} = 5V$, $V_{SS} = 0V$, $V_{CM} = 0V$, $R_L = 5.1k\Omega$, $C_L = 10pF$, overdrive = 100mV, $T_A = +25^\circ C$, unless otherwise noted.)

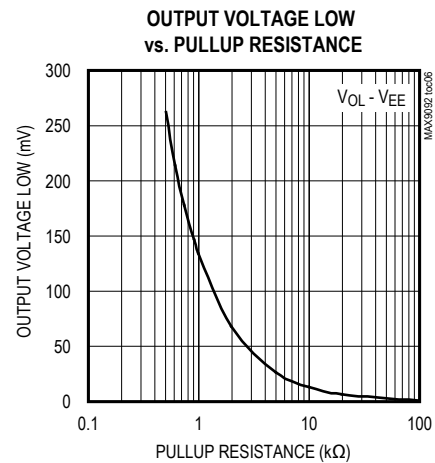
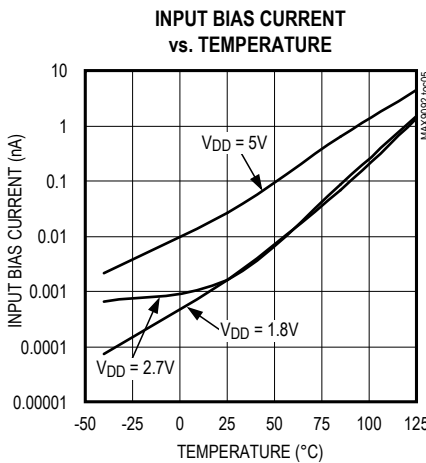
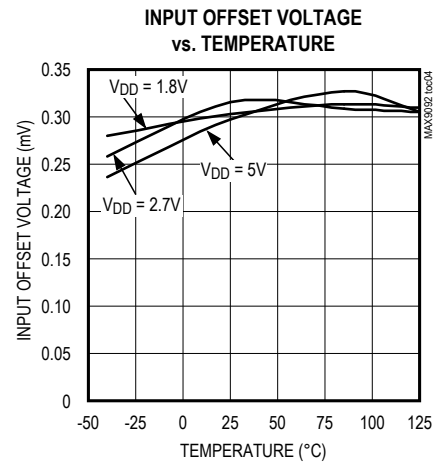
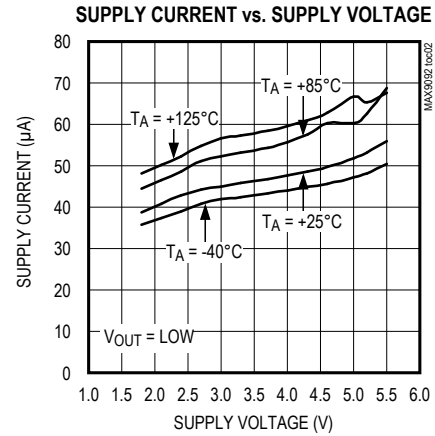

Typical Operating Characteristics (continued)

($V_{DD} = 5V$, $V_{SS} = 0V$, $V_{CM} = 0V$, $R_L = 5.1k\Omega$, $C_L = 10pF$, overdrive = 100mV, $T_A = +25^\circ C$, unless otherwise noted.)

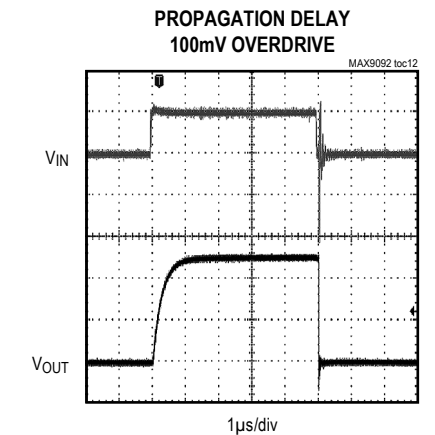
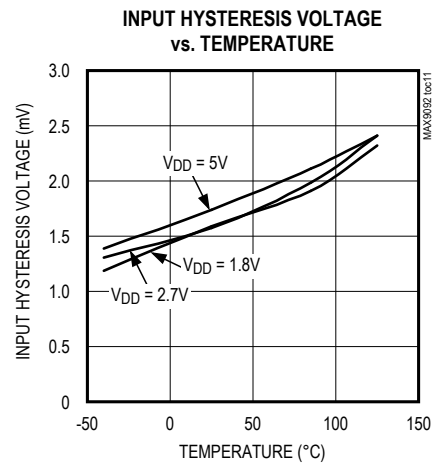
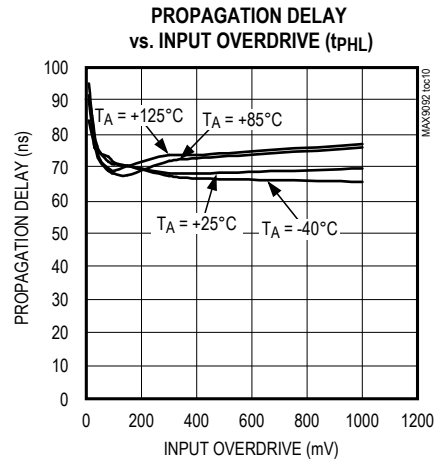
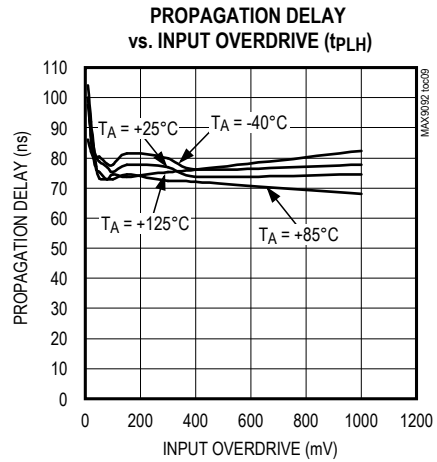
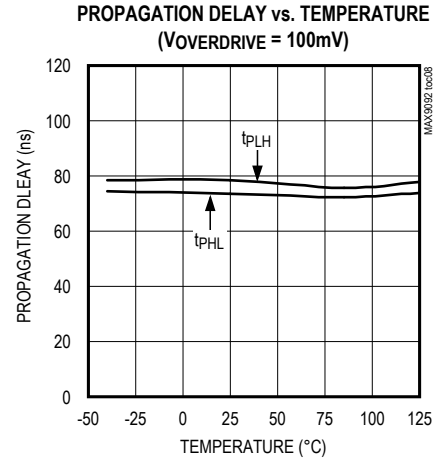
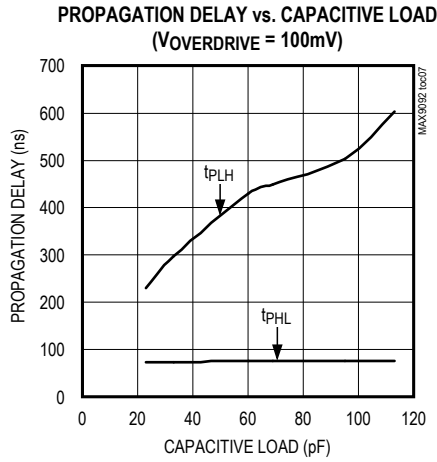

Typical Operating Characteristics (continued)

($V_{DD} = 5V$, $V_{SS} = 0V$, $V_{CM} = 0V$, $R_L = 5.1k\Omega$, $C_L = 10pF$, overdrive = 100mV, $T_A = +25^\circ C$, unless otherwise noted.)

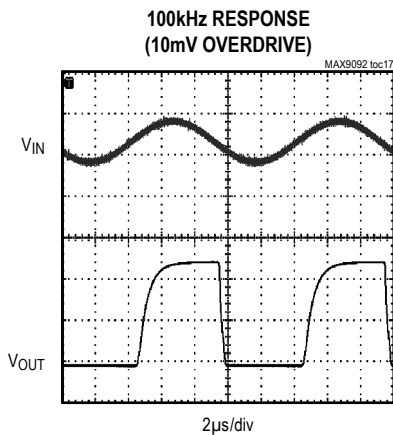
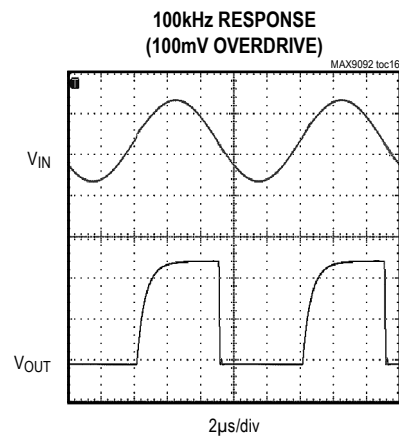
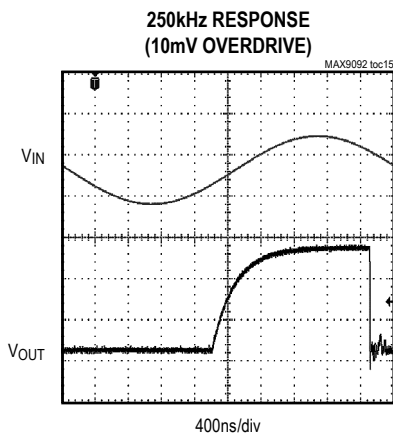
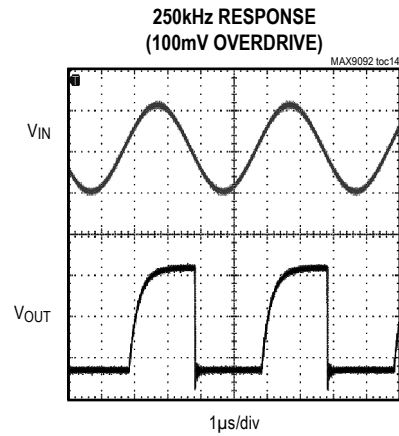
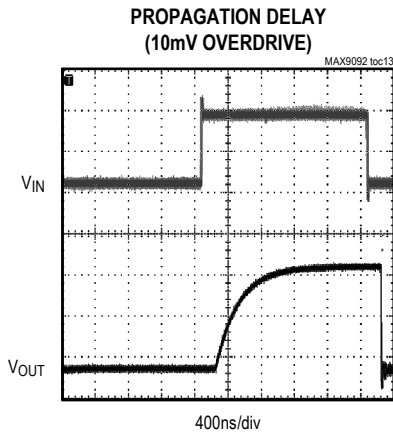

Pin Configurations

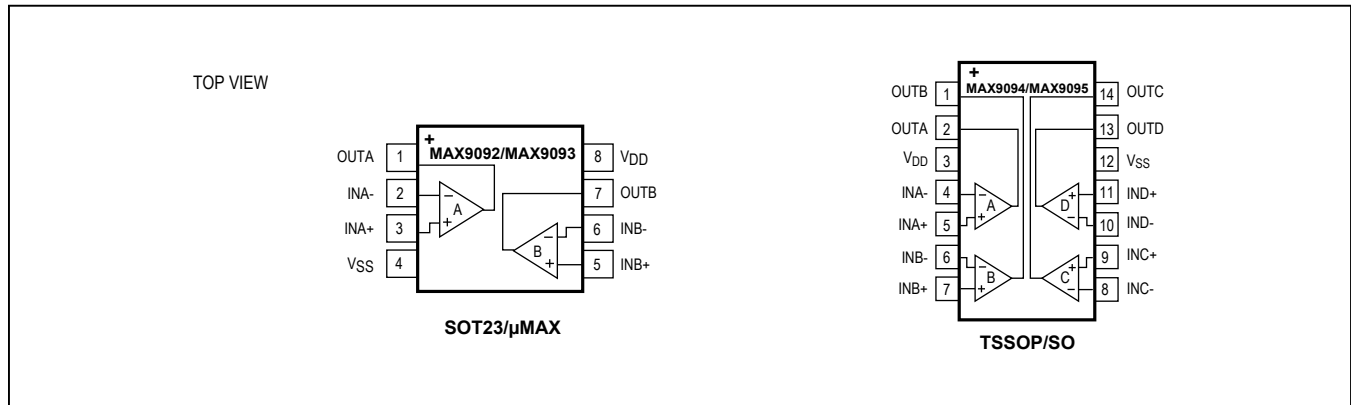

Pin Description

PIN		NAME	FUNCTION
MAX9092/MAX9093	MAX9094/MAX9095		
1	2	OUTA	Comparator A Output (Open Drain)
2	4	INA-	Comparator A Inverting Input
3	5	INA+	Comparator A Noninverting Input
4	12	V _{SS}	Negative Supply (Connect to Ground)
5	7	INB+	Comparator B Noninverting Input
6	6	INB-	Comparator B Inverting Input
7	1	OUTB	Comparator B Output (Open Drain)
8	3	V _{DD}	Positive Supply
—	8	INC-	Comparator C Inverting Input
—	9	INC+	Comparator C Noninverting Input
—	10	IND-	Comparator D Inverting Input
—	11	IND+	Comparator D Noninverting Input
—	13	OUTD	Comparator D Output (Open Drain)
—	14	OUTC	Comparator C Output (Open Drain)

MAX9092/MAX9093/ MAX9094/MAX9095

General-Purpose, Low-Voltage, Dual/Quad, Tiny Pack Comparators

Detailed Description

The MAX9092/MAX9093/MAX9094/MAX9095 are low-cost, general-purpose comparators that have a single-supply +1.8V to +5V operating voltage range. The common-mode input range extends from -0.1V below the negative supply to within +0.8V of the positive supply. They require approximately 65µA per comparator with a 5V supply and 50µA with a 2.7V supply.

The MAX9093/MAX9095 have 2mV of hysteresis for noise immunity. This significantly reduces the chance of output oscillations even with slow-moving input signals.

Applications Information

Hysteresis

Many comparators oscillate in the linear region of operation because of noise or undesired parasitic feedback. This tends to occur when the voltage on one input is equal or very close to the voltage on the other input. The MAX9093/MAX9095 have internal hysteresis to counter parasitic effects and noise.

The hysteresis in a comparator creates two trip points: one for the rising input voltage and one for the falling input voltage (Figure 1). The difference between the trip points is the hysteresis. When the comparator's input voltages are equal, the hysteresis effectively causes one comparator input to move quickly past the other, thus taking the input out of the region where oscillation occurs. This provides clean output transitions for noisy, slow-moving input signals.

Additional hysteresis can be generated with two resistors using positive feedback (Figure 2). Use the following procedure to calculate resistor values:



Figure 1. Threshold Hysteresis Band (Not to Scale)

- 1) Find output voltage when output is high:

$$V_{OUT(HIGH)} = V_{DD} - I_{LOAD} \times R_L$$

- 2) Find the trip points of the comparator using these formulas:

$$V_{TH} = V_{REF} + ((V_{OUT(HIGH)} - V_{REF})R_2)/(R_1 + R_2)$$

$$V_{TL} = V_{REF}(1 - (R_2/(R_1 + R_2)))$$

where V_{TH} is the threshold voltage at which the comparator switches its output from high to low as V_{IN} rises above the trip point, and V_{TL} is the threshold voltage at which the comparator switches its output from low to high as V_{IN} drops below the trip point.

- 3) The hysteresis band is:

$$V_{HYST} = V_{TH} - V_{TL} = V_{DD}(R_2/(R_1 + R_2))$$

In this example, let $V_{DD} = 5V$, $V_{REF} = 2.5V$, $I_{LOAD} = 50nA$, and $R_L = 5.1k\Omega$.

$$V_{OUT(HIGH)} = 5.0V - (50 \times 10^{-9} \times 5.1 \times 10^3\Omega) \approx 5.0V$$

$$V_{TH} = 2.5 + 2.5(R_2/(R_1 + R_2))$$

$$V_{TL} = 2.5(1 - (R_2/(R_1 + R_2)))$$

Select R_2 . In this example, choose 1kΩ.

Select V_{HYST} . In this example, choose 50mV.

Solve for R_1 .

$$V_{HYST} = V_{OUT(HIGH)}(R_2/(R_1 + R_2))V$$

$$0.050V = 5(1000/(R_1 + 1000))V$$

where $R_1 \approx 100k\Omega$, $V_{TH} = 2.525V$, and $V_{TL} = 2.475V$

Choose R_1 and R_2 to be large enough as not to exceed the amount of current the reference can supply.

The source current required is $V_{REF}/(R_1 + R_2)$.

The sink current is $(V_{OUT(HIGH)} - V_{REF}) \times (R_1 + R_2)$.



Figure 2. Adding Hysteresis with External Resistors

MAX9092/MAX9093/ MAX9094/MAX9095

General-Purpose, Low-Voltage, Dual/Quad, Tiny Pack Comparators

Choose R_L to be large enough to avoid drawing excess current, yet small enough to supply the necessary current to drive the load. R_L should be between 1k Ω and 10k Ω . Choose R_1 to be much larger than R_L to avoid lowering $V_{OUT(HIGH)}$ or raising $V_{OUT(LOW)}$.

Board Layout and Bypassing

Use 0.1 μ F bypass capacitors from V_{DD} to V_{SS} . To maximize performance, minimize stray inductance by putting this capacitor close to the V_{DD} pin and reducing trace lengths. For slow-moving input signals (rise time > 1ms), use a 1nF capacitor between $IN+$ and $IN-$ to reduce high frequency noise.

Chip Information

PROCESS: BiCMOS

Ordering Information

PART	TEMP RANGE	PIN-PACKAGE	TOP MARK
MAX9092 AKA+	-40°C to +125°C	8 SOT23	+AESO
MAX9092AUA+	-40°C to +125°C	8 μ MAX	—
MAX9093 AKA+	-40°C to +125°C	8 SOT23	+AESP
MAX9093AUA+	-40°C to +125°C	8 μ MAX	—
MAX9094 ASD+	-40°C to +125°C	14 SO	—
MAX9094AUD+	-40°C to +125°C	14 TSSOP	—
MAX9095 ASD+	-40°C to +125°C	14 SO	—
MAX9095AUD+	-40°C to +125°C	14 TSSOP	—

+Denotes lead(Pb)-free/RoHS-compliant package.

Package Information

For the latest package outline information and land patterns (footprints), go to www.maximintegrated.com/packages. Note that a "+", "#", or "-" in the package code indicates RoHS status only. Package drawings may show a different suffix character, but the drawing pertains to the package regardless of RoHS status.

PACKAGE TYPE	PACKAGE CODE	OUTLINE NO.	LAND PATTERN NO.
8 SOT23	K8+5	21-0078	90-0176
8 μ MAX	U8+1	21-0036	90-0092
14 SO	S14+1	21-0041	90-0112
14 TSSOP	U14+1	21-0066	90-0113

Revision History

REVISION NUMBER	REVISION DATE	DESCRIPTION	PAGES CHANGED
0	8/12	Initial release	—
1	1/13	Revised <i>Absolute Maximum Ratings</i> , <i>Electrical Characteristics</i> , and introduced the MAX9094/MAX9095 and released the MAX9092AUA+ and MAX9093AUA+	2, 3, 10
2	9/14	Removed automotive reference from data sheet	1, 9

For pricing, delivery, and ordering information, please contact Maxim Direct at 1-888-629-4642, or visit Maxim Integrated's website at www.maximintegrated.com.

Maxim Integrated cannot assume responsibility for use of any circuitry other than circuitry entirely embodied in a Maxim Integrated product. No circuit patent licenses are implied. Maxim Integrated reserves the right to change the circuitry and specifications without notice at any time. The parametric values (min and max limits) shown in the Electrical Characteristics table are guaranteed. Other parametric values quoted in this data sheet are provided for guidance.



Компания «ЭлектроПласт» предлагает заключение долгосрочных отношений при поставках импортных электронных компонентов на взаимовыгодных условиях!

Наши преимущества:

- Оперативные поставки широкого спектра электронных компонентов отечественного и импортного производства напрямую от производителей и с крупнейших мировых складов;
- Поставка более 17-ти миллионов наименований электронных компонентов;
- Поставка сложных, дефицитных, либо снятых с производства позиций;
- Оперативные сроки поставки под заказ (от 5 рабочих дней);
- Экспресс доставка в любую точку России;
- Техническая поддержка проекта, помощь в подборе аналогов, поставка прототипов;
- Система менеджмента качества сертифицирована по Международному стандарту ISO 9001;
- Лицензия ФСБ на осуществление работ с использованием сведений, составляющих государственную тайну;
- Поставка специализированных компонентов (Xilinx, Altera, Analog Devices, Intersil, Interpoint, Microsemi, Aeroflex, Peregrine, Syfer, Eurofarad, Texas Instrument, Miteq, Cobham, E2V, MA-COM, Hittite, Mini-Circuits, General Dynamics и др.);

Помимо этого, одним из направлений компании «ЭлектроПласт» является направление «Источники питания». Мы предлагаем Вам помощь Конструкторского отдела:

- Подбор оптимального решения, техническое обоснование при выборе компонента;
- Подбор аналогов;
- Консультации по применению компонента;
- Поставка образцов и прототипов;
- Техническая поддержка проекта;
- Защита от снятия компонента с производства.



Как с нами связаться

Телефон: 8 (812) 309 58 32 (многоканальный)

Факс: 8 (812) 320-02-42

Электронная почта: org@eplast1.ru

Адрес: 198099, г. Санкт-Петербург, ул. Калинина, дом 2, корпус 4, литера А.