



## MIC23153

### 4MHz PWM 2A Buck Regulator with HyperLight Load™ and Power Good

#### General Description

The MIC23153 is a high-efficiency, 4MHz, 2A, synchronous buck regulator with HyperLight Load™ mode, Power Good output indicator, and programmable soft-start. HyperLight Load™ provides very-high efficiency at light loads and ultra-fast transient response which makes the MIC23153 perfectly suited for supplying processor core voltages. An additional benefit of this proprietary architecture is very-low output ripple voltage throughout the entire load range with the use of small output capacitors. The tiny 2.5mm x 2.5mm Thin MLF® package saves precious board space and requires only four external components.

The MIC23153 is designed for use with a very-small inductor, down to 0.47µH, and an output capacitor as small as 2.2 µF that enables a total solution size, less than 1mm in height.

The MIC23153 has a very-low quiescent current of 22µA and achieves a peak efficiency of 93% in continuous conduction mode. In discontinuous conduction mode, the MIC23153 can achieve 85% efficiency at 1mA.

The MIC23153 is available in 10-pin 2.5mm x 2.5mm Thin MLF® package with an operating junction temperature range from -40°C to +125°C.

Datasheets and support documentation can be found on Micrel's web site at: [www.micrel.com](http://www.micrel.com).

#### Features

- Input voltage: 2.7V to 5.5V
- Output voltage: fixed or adjustable (0.62V to 3.6V)
- Up to 2A output current
- Up to 93% peak efficiency
- 85% typical efficiency at 1mA
- Power Good output
- Programmable soft-start
- 22µA typical quiescent current
- 4MHz PWM operation in continuous mode
- Ultra-fast transient response
- Low ripple output voltage
  - 35mVpp ripple in HyperLight Load™ mode
  - 5mV output voltage ripple in full PWM mode
- Fully integrated MOSFET switches
- 0.01µA shutdown current
- Thermal shutdown and current-limit protection
- 10-pin 2.5mm x 2.5mm Thin MLF®
- -40°C to +125°C junction temperature range

#### Applications

- Solid State Drives (SSD)
- Mobile handsets
- Portable media/MP3 players
- Portable navigation devices (GPS)
- WiFi/WiMax/WiBro modules
- Wireless LAN cards
- Portable applications

#### Typical Application

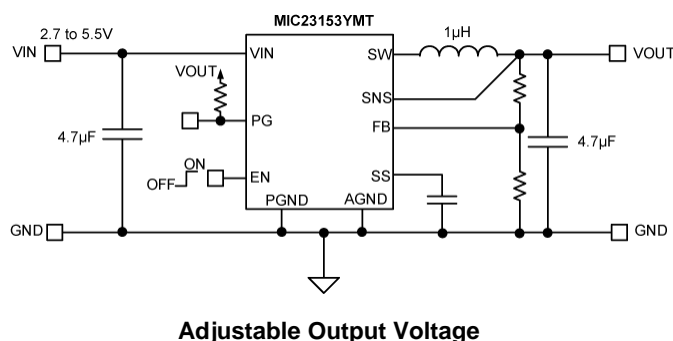
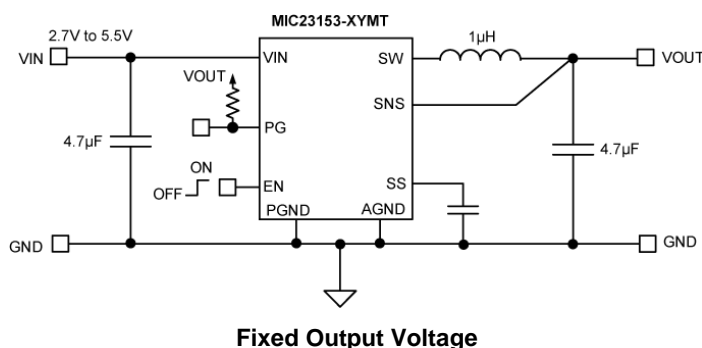

HyperLight Load is a trademark of Micrel, Inc.  
MLF and MicroLeadFrame are registered trademark Amkor Technology Inc.

Micrel Inc. • 2180 Fortune Drive • San Jose, CA 95131 • USA • tel +1 (408) 944-0800 • fax + 1 (408) 474-1000 • <http://www.micrel.com>

## Ordering Information

Part Number	Marking Code	Nominal Output Voltage	Junction Temperature Range	Package
MIC23153-GYMT	WEG	1.8V	-40°C to +125°C	10-Pin 2.5mm x 2.5mm Thin MLF <sup>®</sup>
MIC23153YMT	WEA	Adjustable	-40°C to +125°C	10-Pin 2.5mm x 2.5mm Thin MLF <sup>®</sup>

**Notes:**

1. Other options available (1V - 3.3V). Contact Micrel Marketing for details.
2. Thin MLF<sup>®</sup> is GREEN RoHS-compliant package. Lead finish is NiPdAu. Mold compound is Halogen Free.
3. Thin MLF<sup>®</sup> ▲ = Pin 1 identifier.

## Pin Configuration

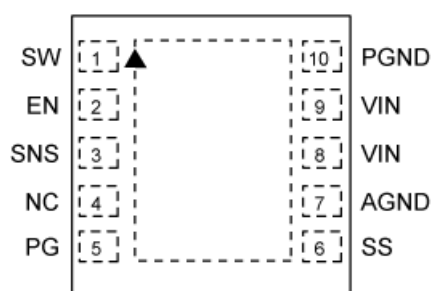

**2.5mm x 2.5mm Thin MLF<sup>®</sup> (MT)  
Fixed Output Voltage  
(Top View)**

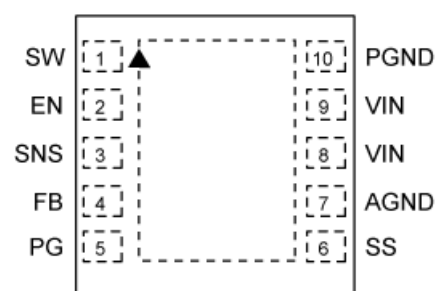

**2.5mm x 2.5mm Thin MLF<sup>®</sup> (MT)  
Adjustable Output Voltage  
(Top View)**

## Pin Description

Pin Number (Fixed)	Pin Number (Adjustable)	Pin Name	Pin Function
1	1	SW	Switch (Output): Internal power MOSFET output switches.
2	2	EN	Enable (Input): Logic high enables operation of the regulator. Logic low will shut down the device. Do not leave floating.
3	3	SNS	Sense: Connect to $V_{OUT}$ as close to output capacitor as possible to sense output voltage.
4	-	NC	Not Internally Connected.
-	4	FB	Feedback: Connect a resistor divider from the output to ground to set the output voltage.
5	5	PG	Power Good: Open drain output for the power good indicator. Use a pull-up resistor from this pin to a voltage source to detect a power good condition.
6	6	SS	Soft Start: Place a capacitor from this pin to ground to program the soft start time. Do not leave floating, 100pF minimum $C_{SS}$ is required.
7	7	AGND	Analog Ground: Connect to central ground point where all high current paths meet ( $C_{IN}$ , $C_{OUT}$ , PGND) for best operation.
8, 9	8, 9	VIN	Input Voltage: Connect a capacitor to ground to decouple the noise.
10	10	PGND	Power Ground.

**Absolute Maximum Ratings<sup>(1)</sup>**

Supply Voltage ( $V_{IN}$ )	-0.3V to 6V
Sense Voltage ( $V_{SNS}$ )	-0.3V to $V_{IN}$
Output Switch Voltage ( $V_{SW}$ )	-0.3V to $V_{IN}$
Enable Input Voltage ( $V_{EN}$ )	-0.3V to $V_{IN}$
Power Good Voltage ( $V_{PG}$ )	-0.3V to $V_{IN}$
Junction Temperature ( $T_J$ )	+150°C
Storage Temperature Range ( $T_S$ )	-65°C to +150°C
Lead Temperature (soldering, 10s)	260°C
ESD Rating <sup>(3)</sup>	ESD Sensitive

**Operating Ratings<sup>(2)</sup>**

Supply Voltage ( $V_{IN}$ )	2.7V to 5.5V
Enable Input Voltage ( $V_{EN}$ )	0V to $V_{IN}$
Sense Voltage ( $V_{SNS}$ )	0.62V to 3.6V
Junction Temperature Range ( $T_J$ )	-40°C ≤ $T_J$ ≤ +125°C
Thermal Resistance	
2.5mm x 2.5mm Thin MLF <sup>®</sup> -10 ( $\theta_{JA}$ )	90°C/W
2.5mm x 2.5mm Thin MLF <sup>®</sup> -10 ( $\theta_{JC}$ )	63°C/W

**Electrical Characteristics<sup>(4)</sup>**

$T_A = 25^\circ\text{C}$ ;  $V_{IN} = V_{EN} = 3.6\text{V}$ ;  $L = 1.0\mu\text{H}$ ;  $C_{OUT} = 4.7\mu\text{F}$  unless otherwise specified.

**Bold** values indicate  $-40^\circ\text{C} \leq T_J \leq +125^\circ\text{C}$ , unless noted.

Parameter	Condition	Min.	Typ.	Max.	Units
Supply Voltage Range		<b>2.7</b>		<b>5.5</b>	V
Undervoltage Lockout Threshold	(Turn-On)	<b>2.45</b>	2.55	<b>2.65</b>	V
Undervoltage Lockout Hysteresis			75		mV
Quiescent Current	$I_{OUT} = 0\text{mA}$ , $SNS > 1.2 * V_{OUT}$ Nominal		22	<b>45</b>	$\mu\text{A}$
Shutdown Current	$V_{EN} = 0\text{V}$ ; $V_{IN} = 5.5\text{V}$		0.01	<b>5</b>	$\mu\text{A}$
Output Voltage Accuracy	$V_{IN} = 3.6\text{V}$ if $V_{OUTNOM} < 2.5\text{V}$ , $I_{LOAD} = 20\text{mA}$	<b>-2.5</b>		<b>+2.5</b>	%
	$V_{IN} = 4.5\text{V}$ if $V_{OUTNOM} \geq 2.5\text{V}$ , $I_{LOAD} = 20\text{mA}$				
Feedback Regulation Voltage	$I_{LOAD} = 20\text{mA}$	<b>0.6045</b>	0.62	<b>0.635</b>	V
Current Limit	$SNS = 0.9 * V_{OUTNOM}$	<b>2.2</b>	3.3		A
Output Voltage Line Regulation	$V_{IN} = 3.6\text{V}$ to $5.5\text{V}$ if $V_{OUTNOM} < 2.5\text{V}$ , $I_{LOAD} = 20\text{mA}$		0.3		%/V
	$V_{IN} = 4.5\text{V}$ to $5.5\text{V}$ if $V_{OUTNOM} \geq 2.5\text{V}$ , $I_{LOAD} = 20\text{mA}$				
Output Voltage Load Regulation	$20\text{mA} < I_{LOAD} < 500\text{mA}$ , $V_{IN} = 3.6\text{V}$ if $V_{OUTNOM} < 2.5\text{V}$		0.3		%
	$20\text{mA} < I_{LOAD} < 500\text{mA}$ , $V_{IN} = 5.0\text{V}$ if $V_{OUTNOM} \geq 2.5\text{V}$				
	$20\text{mA} < I_{LOAD} < 1\text{A}$ , $V_{IN} = 3.6\text{V}$ if $V_{OUTNOM} < 2.5\text{V}$		0.7		%
	$20\text{mA} < I_{LOAD} < 1\text{A}$ , $V_{IN} = 5.0\text{V}$ if $V_{OUTNOM} \geq 2.5\text{V}$				
PWM Switch ON-Resistance	$I_{SW} = 100\text{mA}$ PMOS		0.2		$\Omega$
	$I_{SW} = -100\text{mA}$ NMOS		0.19		
Switching Frequency	$I_{OUT} = 120\text{mA}$		4		MHz
Soft-Start Time	$V_{OUT} = 90\%$ , $C_{SS} = 470\text{pF}$		320		$\mu\text{s}$
Soft-Start Current	$V_{SS} = 0\text{V}$		2.7		$\mu\text{A}$
Power Good Threshold (Rising)		86	92	96	%
Power Good Threshold Hysteresis			7		%
Power Good Delay Time	Rising		68		$\mu\text{s}$
Enable Threshold	Turn-On	<b>0.5</b>	0.9	<b>1.2</b>	V
Enable Input Current			0.1	<b>2</b>	$\mu\text{A}$
Over-Temperature Shutdown			160		$^\circ\text{C}$
Over-Temperature Shutdown Hysteresis			20		$^\circ\text{C}$

**Notes:**

- Exceeding the absolute maximum rating may damage the device.
- The device is not guaranteed to function outside its operating rating.
- Devices are ESD sensitive. Handling precautions recommended. Human body model, 1.5k $\Omega$  in series with 100pF.
- Specification for packaged product only.

# Typical Characteristics

**Efficiency vs. Output Current**  
 $V_{OUT} = 1.8V @ 25^{\circ}C$

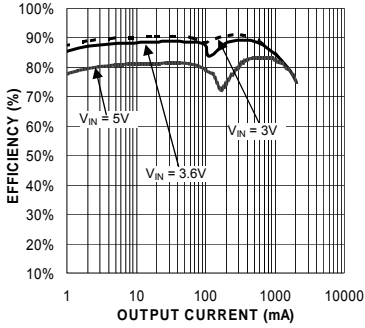

**Efficiency vs. Output Current**  
 $V_{OUT} = 3.3V @ 25^{\circ}C$

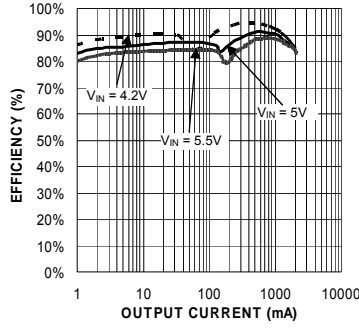

**V<sub>OUT</sub> Rise Time vs. C<sub>SS</sub>**

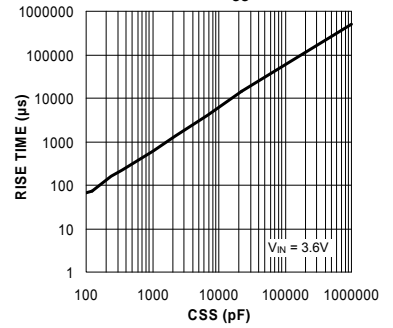

**Current Limit vs. Input Voltage**

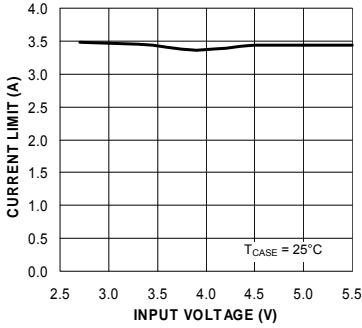

**Shutdown Current vs. Input Voltage**

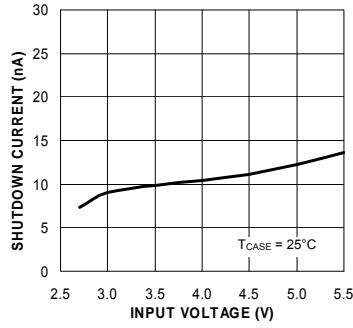

**Line Regulation (Low Loads)**

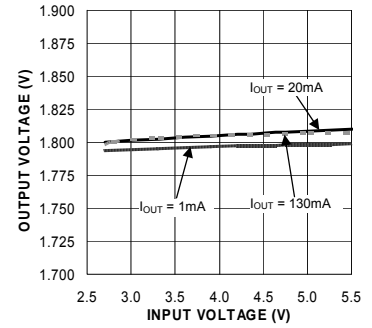

**Line Regulation (High Loads)**

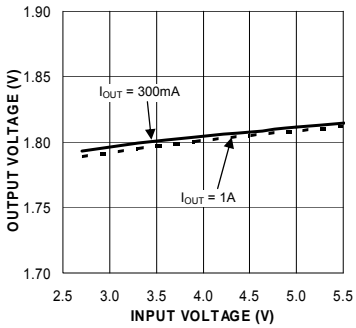

**Output Voltage vs. Output Current (HLL)**

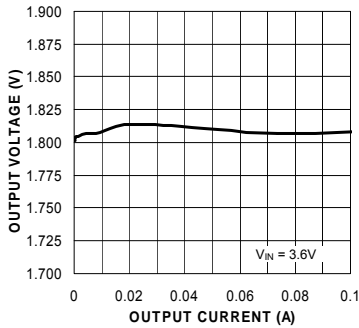

**Output Voltage vs. Output Current (CCM)**

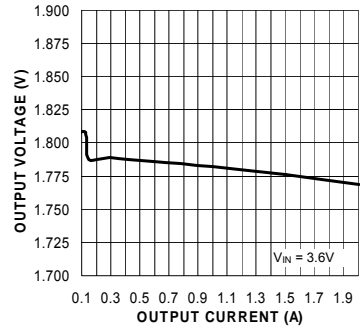

**Output Voltage vs. Temperature**

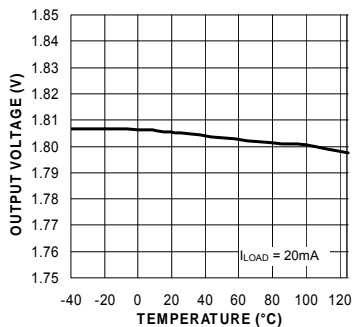

**PG Delay Time vs. Input Voltage**

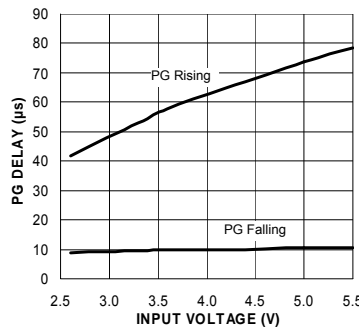

**PG Thresholds vs. Input Voltage**

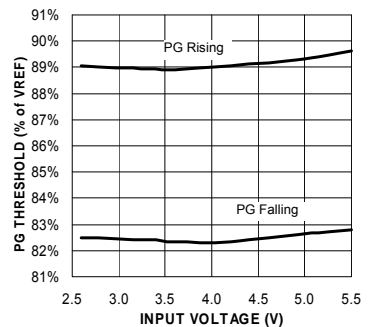

## Typical Characteristics (Continued)

**UVLO Threshold vs. Temperature**

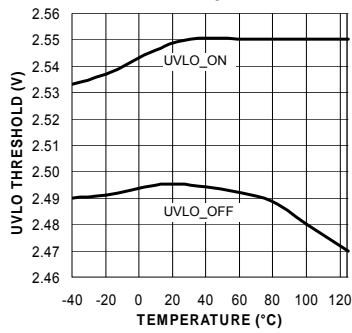

**Enable Threshold vs. Input Voltage**

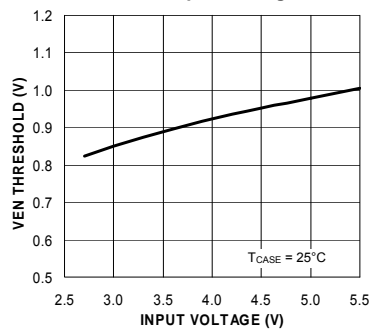

**Enable Threshold vs. Temperature**

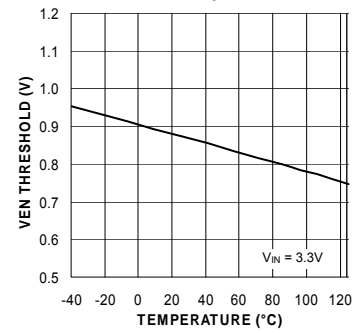

**Switching Frequency vs. Load Current**

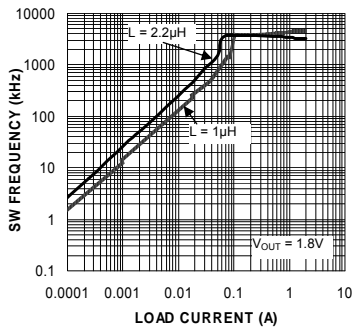

**Feedback Voltage vs. Temperature**

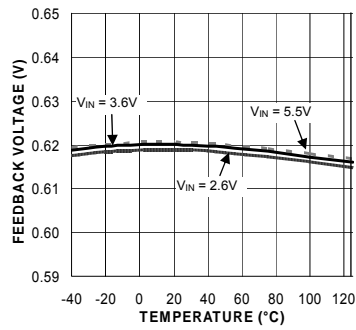

## Functional Characteristics

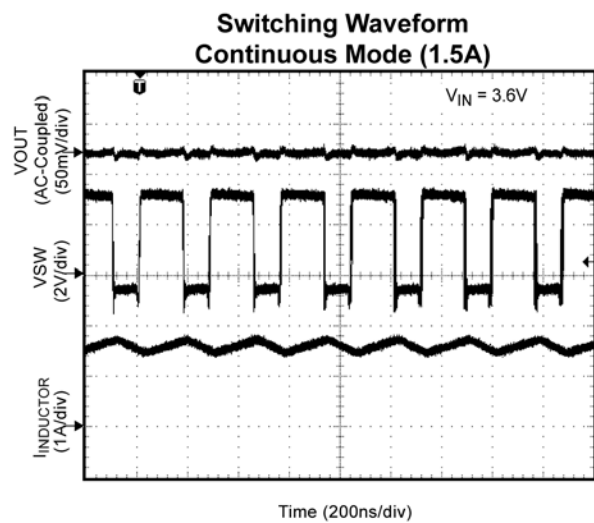
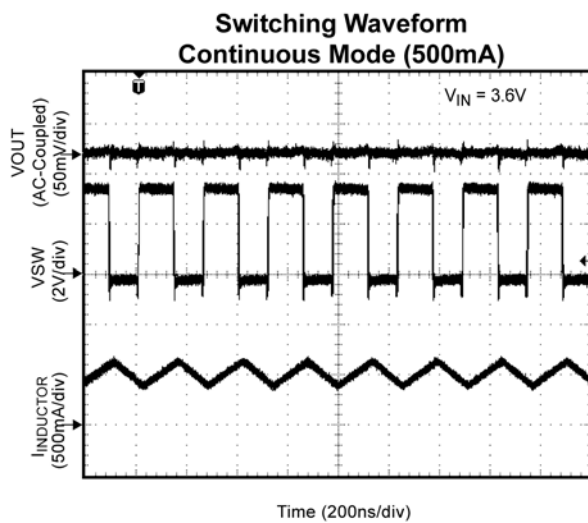
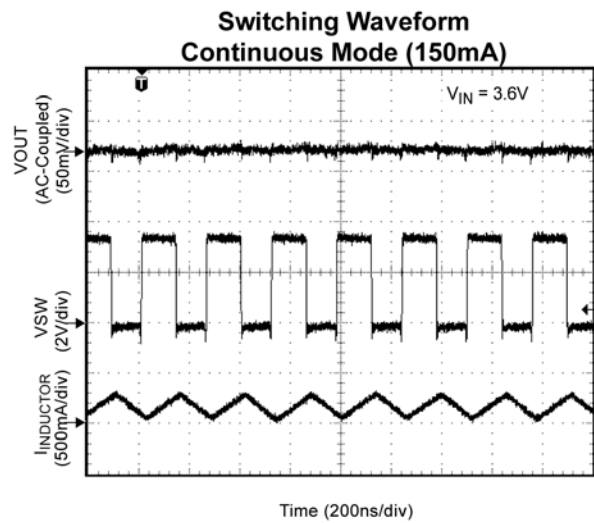
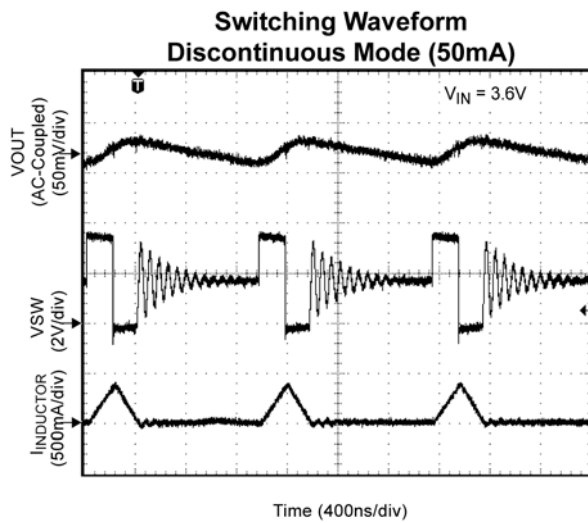
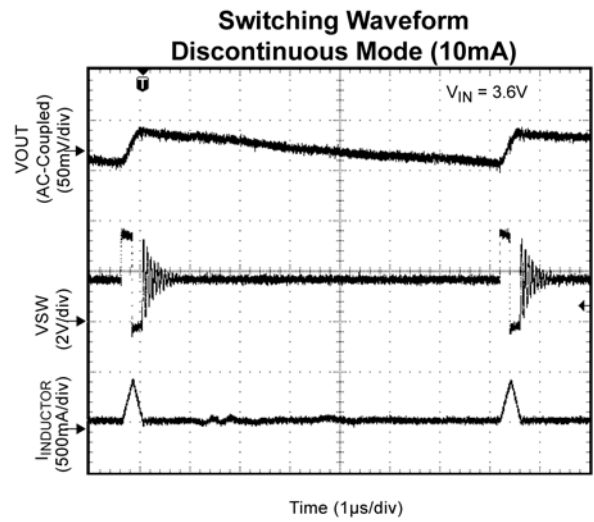
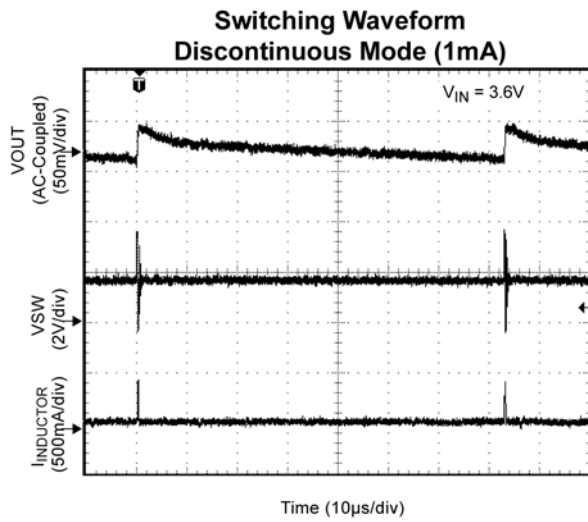

### Functional Characteristics (Continued)

Load Transient (10mA to 200mA)

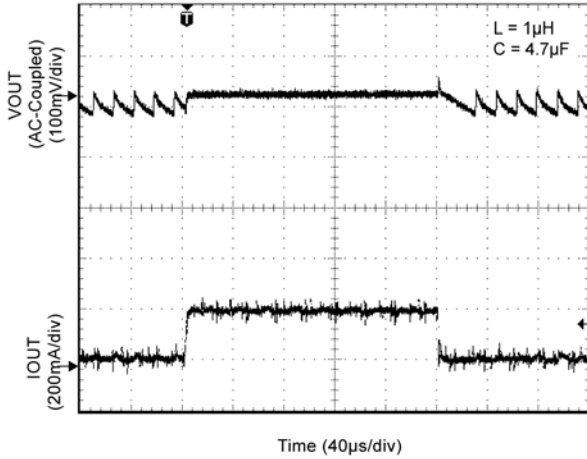

Load Transient (10mA to 500mA)

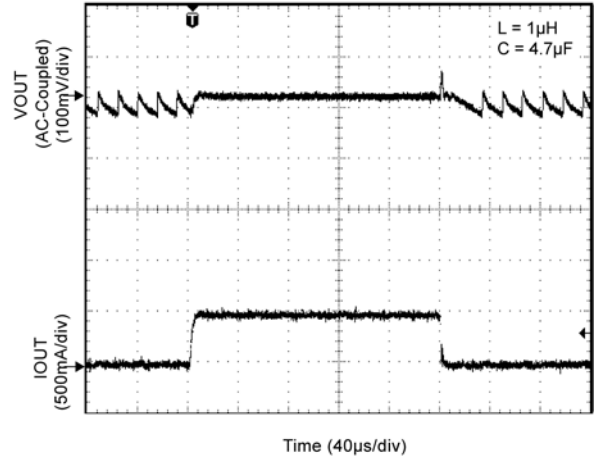

Load Transient (10mA to 750mA)

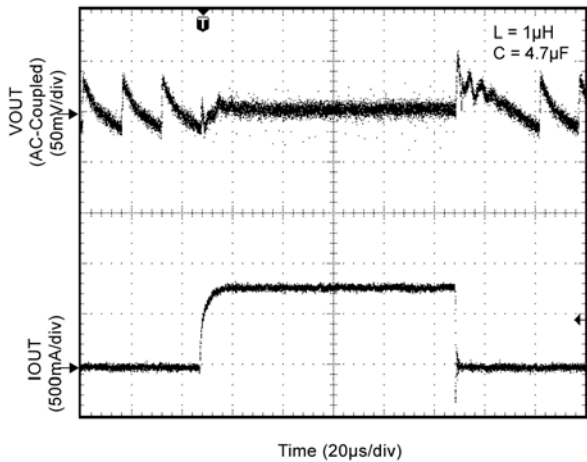

Load Transient (50mA to 1A)

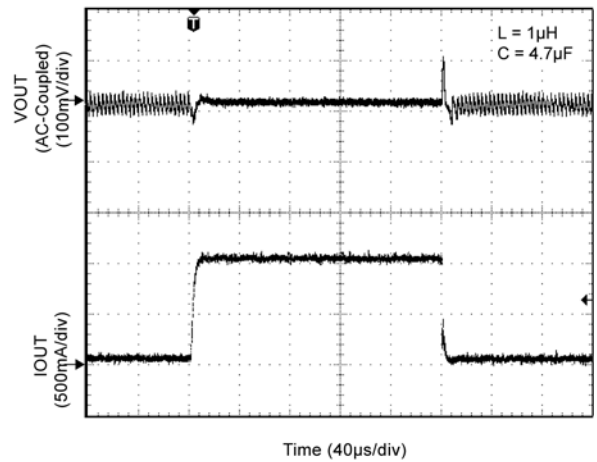

Load Transient (50mA to 1.5A)

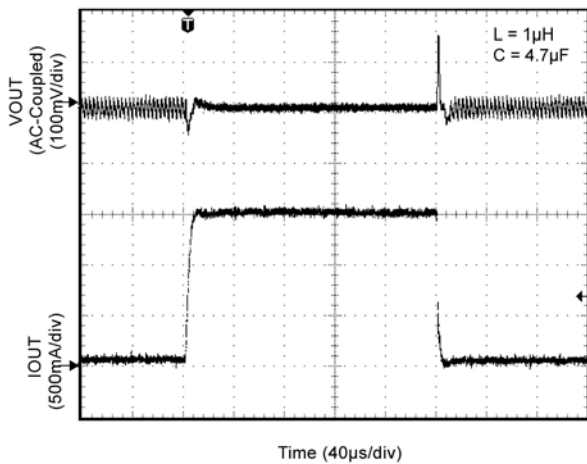

Load Transient (200mA to 600mA)

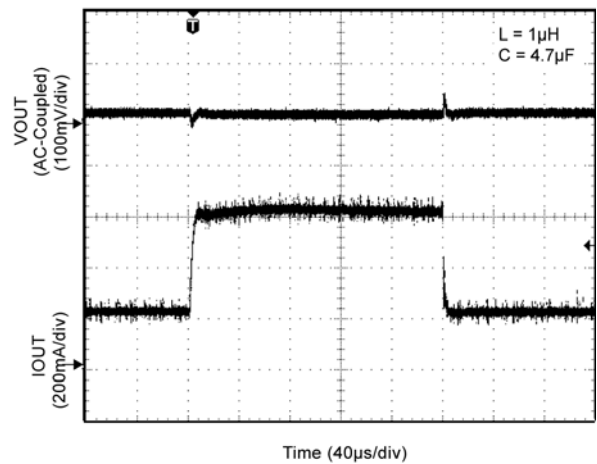

## Functional Characteristics (Continued)

### Load Transient (200mA to 1A)

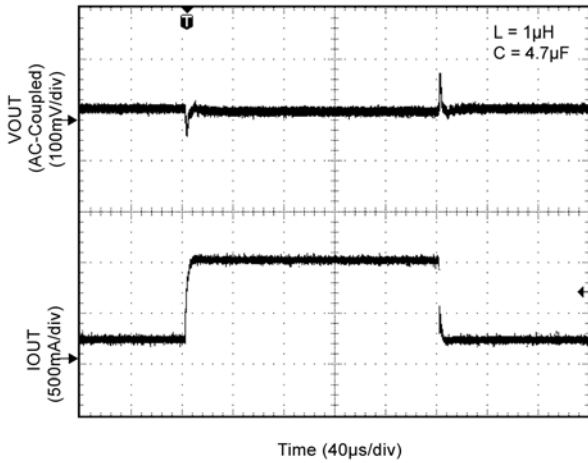

### Load Transient (200mA to 2A)

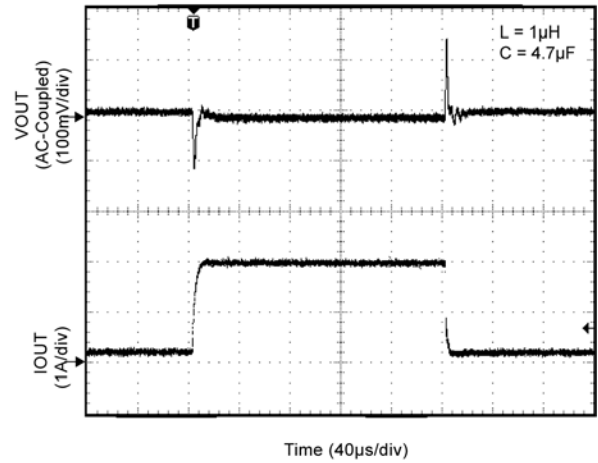

### Line Transient (3.6V to 5.5V @ 1.5A Load)

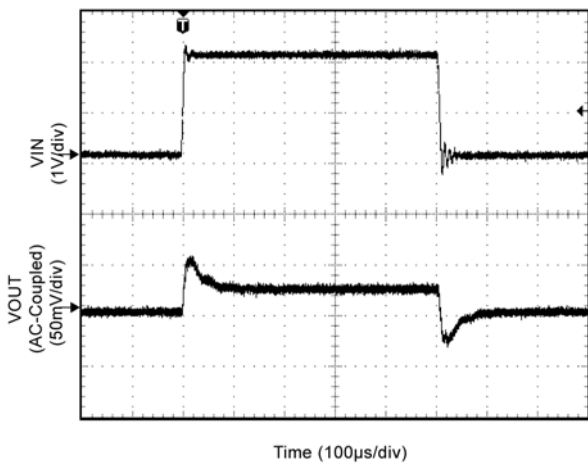

### Line Transient (3.6V to 5.5V @ 20mA Load)

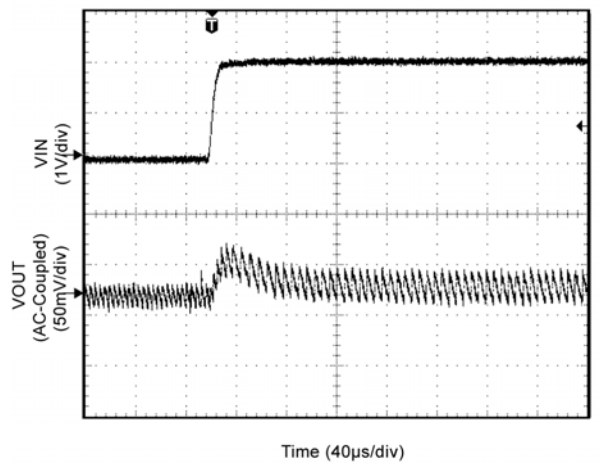

### Start-Up and PG Waveform

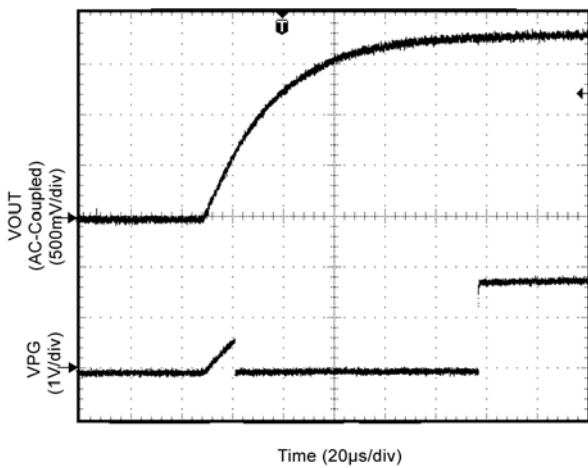



### Functional Diagram

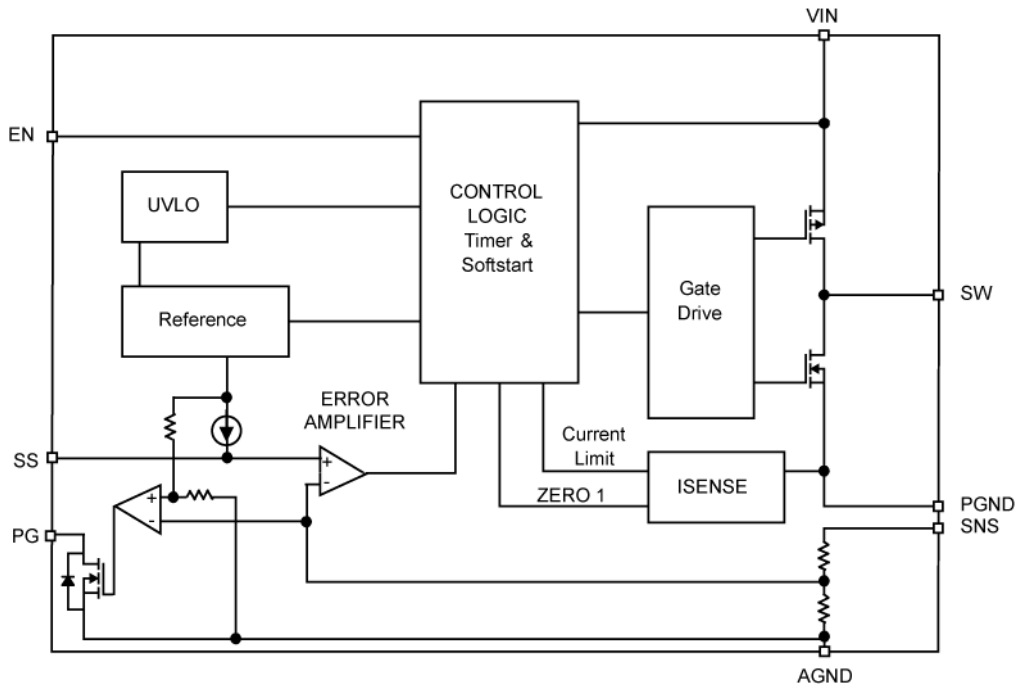

Figure 1. Simplified MIC23153 Functional Block Diagram – Fixed Output Voltage

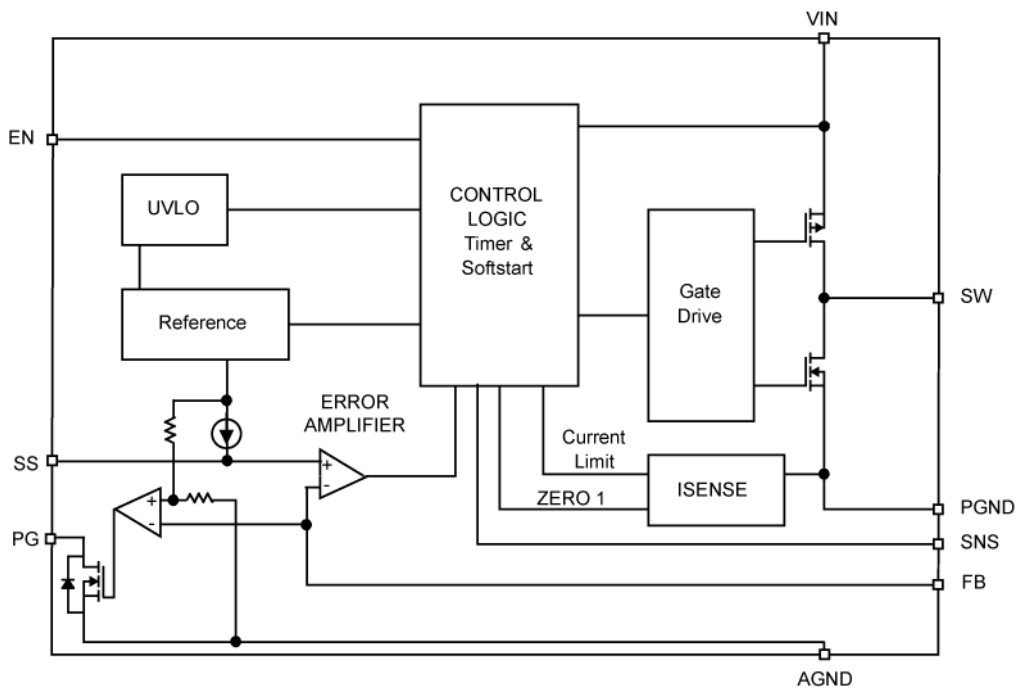

Figure 2. Simplified MIC23153 Functional Block Diagram – Adjustable Output Voltage

## Functional Description

### VIN

The input supply (VIN) provides power to the internal MOSFETs for the switch mode regulator along with the internal control circuitry. The VIN operating range is 2.7V to 5.5V so an input capacitor, with a minimum voltage rating of 6.3V, is recommended. Due to the high switching speed, a minimum 2.2µF bypass capacitor placed close to VIN and the power ground (PGND) pin is required. Refer to the Layout Recommendations for details.

### EN

A logic high signal on the enable pin activates the output voltage of the device. A logic low signal on the enable pin deactivates the output and reduces supply current to 0.01µA. MIC23153 features external soft-start circuitry via the soft start (SS) pin that reduces in-rush current and prevents the output voltage from overshooting at start up. Do not leave the EN pin floating.

### SW

The switch (SW) connects directly to one end of the inductor and provides the current path during switching cycles. The other end of the inductor is connected to the load, SNS pin and output capacitor. Due to the high speed switching on this pin, the switch node should be routed away from sensitive nodes whenever possible.

### SNS

The sense (SNS) pin is connected to the output of the device to provide feedback to the control circuitry. The SNS connection should be placed close to the output capacitor. Refer to the Layout Recommendations for details.

### AGND

The analog ground (AGND) is the ground path for the biasing and control circuitry. The current loop for the signal ground should be separate from the power ground (PGND) loop. Refer to the Layout Recommendations for details.

### PGND

The power ground pin is the ground path for the high current in PWM mode. The current loop for the power ground should be as small as possible and separate from the analog ground (AGND) loop as applicable. Refer to the Layout Recommendations for details.

### PG

The power good (PG) pin is an open drain output which indicates logic high when the output voltage is typically above 92% of its steady state voltage. A pull-up resistor of more than 5kΩ should be connected from PG to V<sub>OUT</sub>.

### SS

The soft start (SS) pin is used to control the output voltage ramp up time. The approximate equation for the ramp time in seconds is  $270 \times 10^3 \times \ln(10) \times C_{SS}$ . For example, for a  $C_{SS} = 470\text{pF}$ ,  $T_{\text{rise}} \sim 300\mu\text{s}$ . See the Typical Characteristics curve for a graphical guide. The minimum recommended value for  $C_{SS}$  is 100pF.

### FB

The feedback (FB) pin is provided for the adjustable voltage option (no internal connection for fixed options). This is the control input for programming the output voltage. A resistor divider network is connected to this pin from the output and is compared to the internal 0.62V reference within the regulation loop.

The output voltage can be programmed between 0.65V and 3.6V using the following equation:

$$V_{\text{OUT}} = V_{\text{REF}} \cdot \left( 1 + \frac{R1}{R2} \right)$$

where:

R1 is the top resistor, R2 is the bottom resistor.

Example feedback resistor values:

V <sub>OUT</sub>	R1	R2
1.2V	274k	294k
1.5V	316k	221k
1.8V	301k	158k
2.5V	324k	107k
3.3V	309k	71.5k

## Application Information

The MIC23153 is a high-performance DC-to-DC step-down regulator offering a small solution size. Supporting an output current up to 2A inside a tiny 2.5mm x 2.5mm Thin MLF® package, the IC requires only three external components while meeting today's miniature portable electronic device needs. Using the HyperLight Load™ switching scheme, the MIC23153 is able to maintain high efficiency throughout the entire load range while providing ultra-fast load transient response. The following sections provide additional device application information.

### Input Capacitor

A 2.2µF ceramic capacitor or greater should be placed close to the VIN pin and PGND pin for bypassing. A Murata GRM188R60J475ME84D, size 0603, 4.7µF ceramic capacitor is recommended based upon performance, size and cost. A X5R or X7R temperature rating is recommended for the input capacitor. Y5V temperature rating capacitors, aside from losing most of their capacitance over temperature, can also become resistive at high frequencies. This reduces their ability to filter out high-frequency noise.

### Output Capacitor

The MIC23153 is designed for use with a 2.2µF or greater ceramic output capacitor. Increasing the output capacitance will lower output ripple and improve load transient response but could also increase solution size or cost. A low equivalent series resistance (ESR) ceramic output capacitor such as the Murata GRM188R60J475ME84D, size 0603, 4.7µF ceramic capacitor is recommended based upon performance, size and cost. Both the X7R or X5R temperature rating capacitors are recommended. The Y5V and Z5U temperature rating capacitors are not recommended due to their wide variation in capacitance over temperature and increased resistance at high frequencies.

### Inductor Selection

When selecting an inductor, it is important to consider the following factors (not necessarily in the order of importance):

- Inductance
- Rated current value
- Size requirements
- DC resistance (DCR)

The MIC23153 is designed for use with a 0.47µH to 2.2µH inductor. For faster transient response, a 0.47µH inductor will yield the best result. For lower output ripple, a 2.2µH inductor is recommended.

Maximum current ratings of the inductor are generally given in two methods; permissible DC current and saturation current. Permissible DC current can be rated either for a 40°C temperature rise or a 10% to 20% loss in inductance. Ensure the inductor selected can handle the maximum operating current. When saturation current is specified, make sure that there is enough margin so that the peak current does not cause the inductor to saturate. Peak current can be calculated as follows:

$$I_{PEAK} = \left[ I_{OUT} + V_{OUT} \left( \frac{1 - V_{OUT}/V_{IN}}{2 \times f \times L} \right) \right]$$

As shown by the calculation above, the peak inductor current is inversely proportional to the switching frequency and the inductance; the lower the switching frequency or the inductance the higher the peak current. As input voltage increases, the peak current also increases.

The size of the inductor depends on the requirements of the application. Refer to the *Typical Application Circuit* and *Bill of Materials* for details.

DC resistance (DCR) is also important. While DCR is inversely proportional to size, DCR can represent a significant efficiency loss. Refer to the *Efficiency Considerations*.

The transition between high loads (CCM) to Hyperlight load (HLL) mode is determined by the inductor ripple current and the load current.

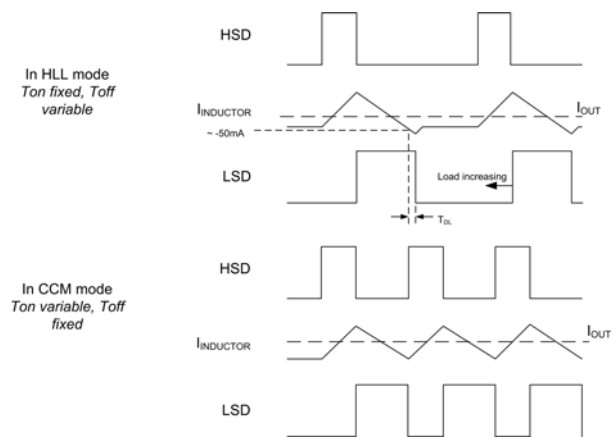

The diagram shows the signals for high side switch drive (HSD) for T<sub>ON</sub> control, the inductor current and the low side switch drive (LSD) for T<sub>OFF</sub> control.

In HLL mode, the inductor is charged with a fixed Ton pulse on the high side switch (HSD). After this, the LSD is switched on and current falls at a rate  $V_{OUT}/L$ . The controller remains in HLL mode while the inductor falling current is detected to cross approximately  $-50\text{mA}$ . When the LSD (or  $T_{OFF}$ ) time reaches its minimum and the inductor falling current is no longer able to reach this  $-50\text{mA}$  threshold, the part is in CCM mode and switching at a virtually constant frequency.

Once in CCM mode, the  $T_{OFF}$  time will not vary. Therefore, it is important to note that if L is large enough, the HLL transition level will not be triggered.

That inductor is:

$$L_{MAX} = \frac{V_{OUT} \times 135\text{ns}}{2 \times 50\text{mA}}$$

**Compensation**

The MIC23153 is designed to be stable with a  $0.47\mu\text{H}$  to  $2.2\mu\text{H}$  inductor with a  $4.7\mu\text{F}$  ceramic (X5R) output capacitor.

**Duty Cycle**

The typical maximum duty cycle of the MIC23153 is 80%.

**Efficiency Considerations**

Efficiency is defined as the amount of useful output power, divided by the amount of power supplied.

$$\text{Efficiency \%} = \left( \frac{V_{OUT} \times I_{OUT}}{V_{IN} \times I_{IN}} \right) \times 100$$

Maintaining high efficiency serves two purposes. It reduces power dissipation in the power supply, reducing the need for heat sinks and thermal design considerations and it reduces consumption of current for battery-powered applications. Reduced current draw from a battery increases the devices operating time and is critical in hand held devices.

There are two types of losses in switching converters; DC losses and switching losses. DC losses are simply the power dissipation of  $I^2R$ . Power is dissipated in the high side switch during the on cycle. Power loss is equal to the high side MOSFET  $R_{DS(ON)}$  multiplied by the Switch Current squared. During the off cycle, the low side N-channel MOSFET conducts, also dissipating power. Device operating current also reduces efficiency. The product of the quiescent (operating) current and the supply voltage represents another DC loss. The current required driving the gates on and off at a constant 4MHz frequency and the switching transitions make up the switching losses.

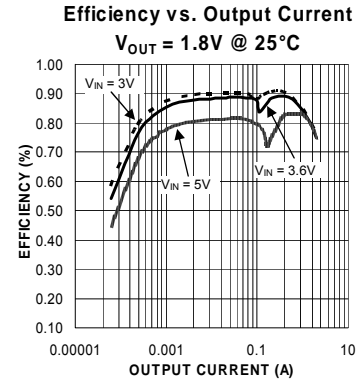

**Figure 2. Efficiency Under Load**

The figure above shows an efficiency curve. From no load to 100mA, efficiency losses are dominated by quiescent current losses, gate drive and transition losses. By using the HyperLight Load™ mode, the MIC23153 is able to maintain high efficiency at low output currents.

Over 100mA, efficiency loss is dominated by MOSFET  $R_{DS(ON)}$  and inductor losses. Higher input supply voltages will increase the Gate-to-Source threshold on the internal MOSFETs, thereby reducing the internal  $R_{DS(ON)}$ . This improves efficiency by reducing DC losses in the device. All but the inductor losses are inherent to the device. In which case, inductor selection becomes increasingly critical in efficiency calculations. As the inductors are reduced in size, the DC resistance (DCR) can become quite significant. The DCR losses can be calculated as follows:

$$P_{DCR} = I_{OUT}^2 \times \text{DCR}$$

From that, the loss in efficiency due to inductor resistance can be calculated as follows:

$$\text{Efficiency Loss} = \left[ 1 - \left( \frac{V_{OUT} \times I_{OUT}}{V_{OUT} \times I_{OUT} + P_{DCR}} \right) \right] \times 100$$

Efficiency loss due to DCR is minimal at light loads and gains significance as the load is increased. Inductor selection becomes a trade-off between efficiency and size in this case.

**HyperLight Load™ Mode**

MIC23153 uses a minimum on and off time proprietary control loop (patented by Micrel). When the output voltage falls below the regulation threshold, the error comparator begins a switching cycle that turns the PMOS on and keeps it on for the duration of the minimum-on-time. This increases the output voltage. If the output voltage is over the regulation threshold, then the error comparator turns the PMOS off for a minimum-off-time until the output drops below the threshold. The NMOS acts as an ideal rectifier that conducts when the PMOS is off. Using a NMOS switch instead of a diode allows for lower voltage drop across the switching device when it is on. The asynchronous switching combination between the PMOS and the NMOS allows the control loop to work in discontinuous mode for light load operations. In discontinuous mode, the MIC23153 works in pulse frequency modulation (PFM) to regulate the output. As the output current increases, the off-time decreases, thus provides more energy to the output. This switching scheme improves the efficiency of MIC23153 during light load currents by only switching when it is needed. As the load current increases, the MIC23153 goes into continuous conduction mode (CCM) and switches at a frequency centered at 4MHz. The equation to calculate the load when the MIC23153 goes into continuous conduction mode may be approximated by the following formula:

$$I_{LOAD} > \left( \frac{(V_{IN} - V_{OUT}) \times D}{2L \times f} \right)$$

As shown in the previous equation, the load at which the MIC23153 transitions from HyperLight Load™ mode to PWM mode is a function of the input voltage ( $V_{IN}$ ), output voltage ( $V_{OUT}$ ), duty cycle ( $D$ ), inductance ( $L$ ) and frequency ( $f$ ). As shown in Figure 3, as the Output Current increases, the switching frequency also increases until the MIC23153 goes from HyperLight Load™ mode to PWM mode at approximately 120mA. The MIC23153 will switch at a relatively constant frequency around 4MHz once the output current is over 120mA.

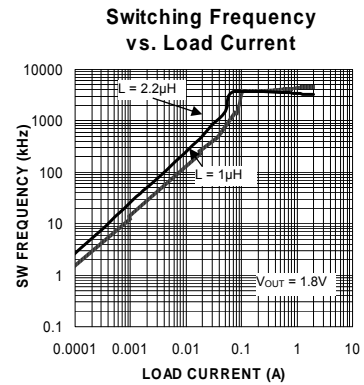

**Figure 3. SW Frequency vs. Output Current**

### Typical Application Circuit (Fixed Output)

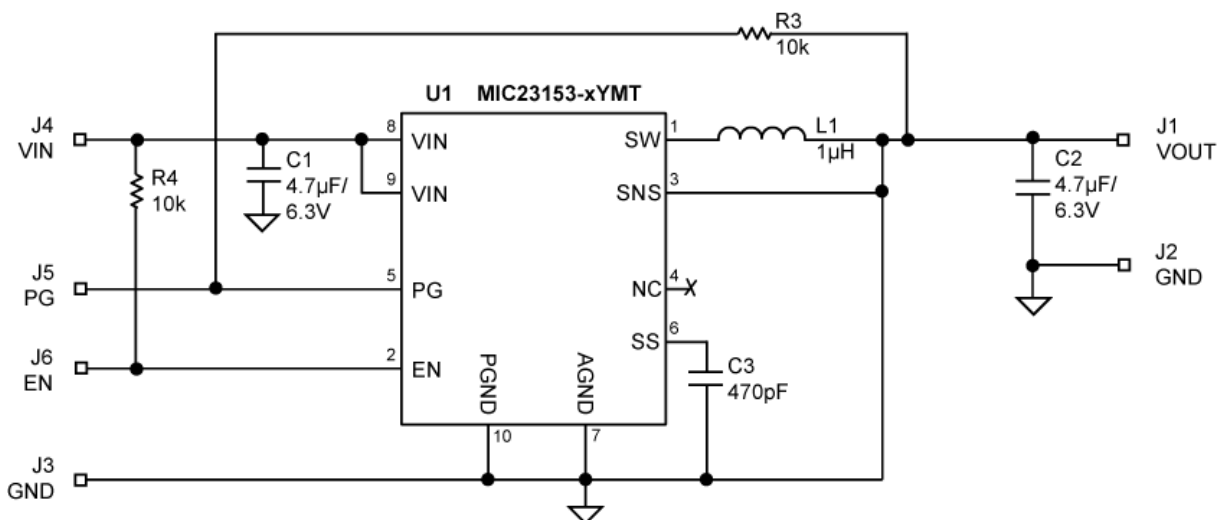

### Bill of Materials

Item	Part Number	Manufacturer	Description	Qty.
C1	C1608X5R0J475K	TDK <sup>(1)</sup>	Ceramic Capacitor, 4.7µF, 6.3V, X5R, Size 0603	1
	GRM188R60J475KE19D	Murata <sup>(2)</sup>		
C2	C1608X5R0J475K	TDK <sup>(1)</sup>		1
	GRM188R60J475KE84D	Murata <sup>(2)</sup>		
C3	C1608NPO0J471K	TDK <sup>(1)</sup>	Ceramic Capacitor, 470pF, 6.3V, NPO, Size 0603	1
L1	VLS3012ST-1R0N1R9	TDK <sup>(1)</sup>	1µH, 2A, 60mΩ, L3.0mm x W3.0mm x H1.0mm	1
	LQH44PN1R0NJ0	Murata <sup>(2)</sup>	1µH, 2.8A, 50mΩ, L4.0mm x W4.0mm x H1.2mm	
R3	CRCW06031002FKEA	Vishay <sup>(3)</sup>	Resistor,10k, Size 0603	1
R4	CRCW06031002FKEA	Vishay <sup>(3)</sup>	Resistor,10k, Size 0603	1
U1	<b>MIC23153-xYMT</b>	<b>Micrel, Inc.<sup>(4)</sup></b>	<b>4MHz 2A Buck Regulator with HyperLight Load™ Mode</b>	<b>1</b>

**Notes:**

1. TDK: [www.tdk.com](http://www.tdk.com).
2. Murata: [www.murata.com](http://www.murata.com).
3. Vishay: [www.vishay.com](http://www.vishay.com).
4. Micrel, Inc.: [www.micrel.com](http://www.micrel.com).

### Typical Application Circuit (Adjustable Output)

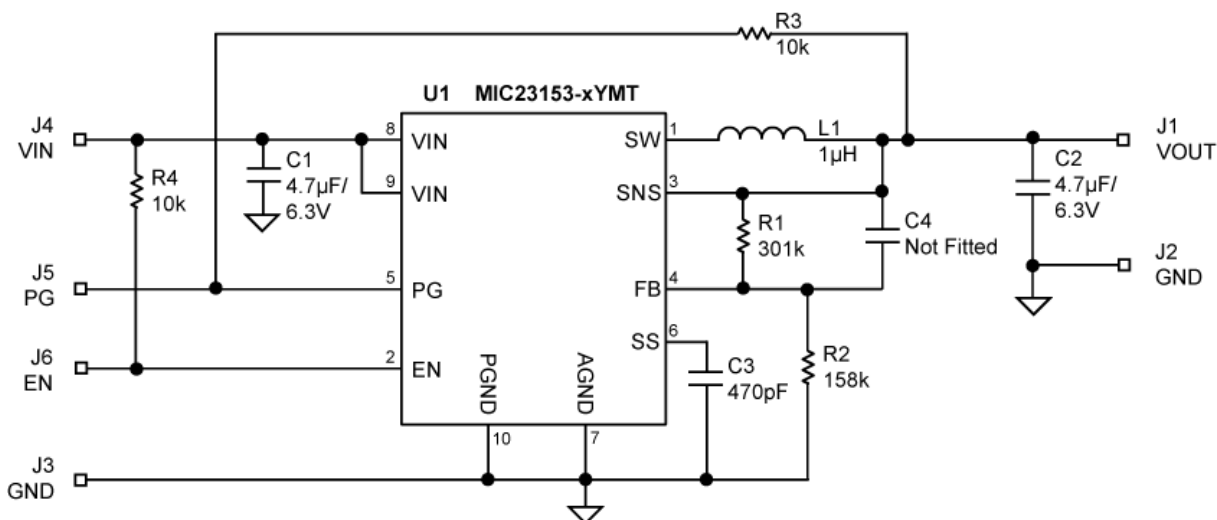

### Bill of Materials

Item	Part Number	Manufacturer	Description	Qty.	
C1	C1608X5R0J475K	TDK <sup>(1)</sup>	Ceramic Capacitor, 4.7µF, 6.3V, X5R, Size 0603	1	
	GRM188R60J475KE19D	Murata <sup>(2)</sup>			
C2	C1608X5R0J475K	TDK <sup>(1)</sup>		Ceramic Capacitor, 4.7µF, 6.3V, X5R, Size 0603	1
	GRM188R60J475KE84D	Murata <sup>(2)</sup>			
C3	C1608NPO0J471K	TDK <sup>(1)</sup>	Ceramic Capacitor, 470pF, 6.3V, NPO, Size 0603	1	
C4	-	-	Not Fitted (NF)	0	
L1	VLS3010ST-1R0N1R9	TDK <sup>(1)</sup>	1µH, 2A, 60mΩ, L3.0mm x W3.0mm x H1.0mm	1	
	LQH44PN1R0NJ0	Murata <sup>(2)</sup>			
R1	CRCW06033013FKEA	Vishay <sup>(3)</sup>	Resistor,301k, Size 0603	1	
R2	CRCW06031583FKEA	Vishay <sup>(3)</sup>	Resistor,158k, Size 0603	1	
R3	CRCW06031002FKEA	Vishay <sup>(3)</sup>	Resistor,10k, Size 0603	1	
R4	CRCW06031002FKEA	Vishay <sup>(3)</sup>	Resistor,10k, Size 0603	1	
U1	MIC23153-AYMT	Micrel, Inc. <sup>(4)</sup>	4MHz 2A Buck Regulator with HyperLight Load™ Mode	1	

**Notes:**

1. TDK: [www.tdk.com](http://www.tdk.com).
2. Murata : [www.murata.com](http://www.murata.com).
3. Vishay: [www.vishay.com](http://www.vishay.com).
4. Micrel, Inc.: [www.micrel.com](http://www.micrel.com).

### PCB Layout Recommendations

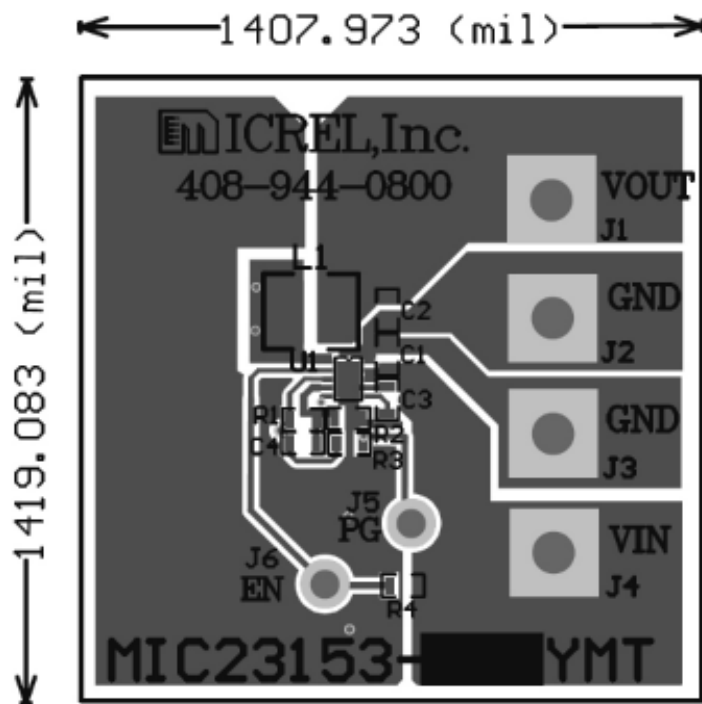

Top Layer

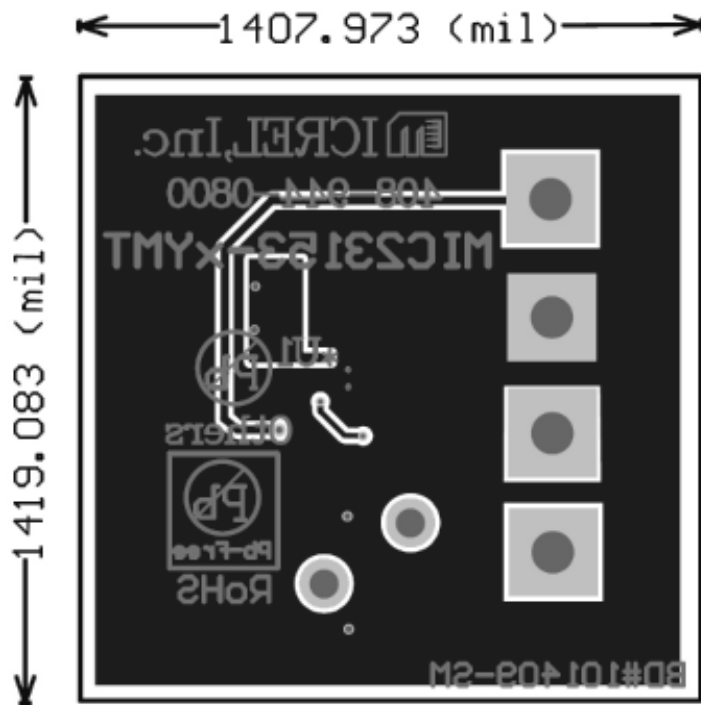

Bottom Layer



### Package Information

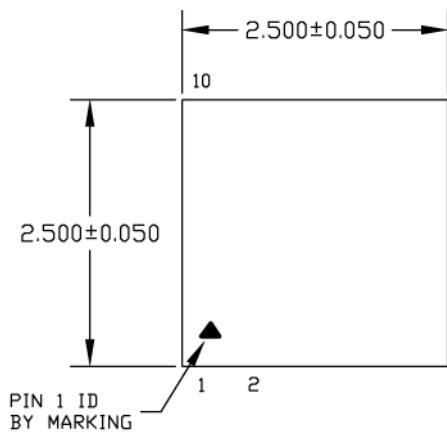

TOP VIEW

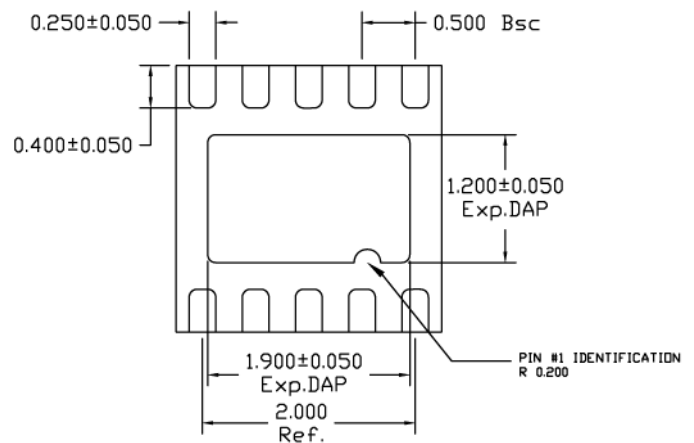

BOTTOM VIEW

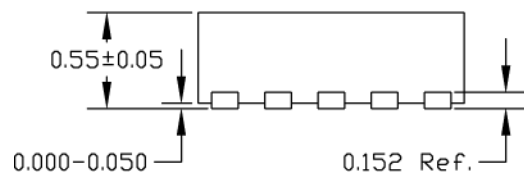

SIDE VIEW

**NOTE:**

1. ALL DIMENSIONS ARE IN MILLIMETERS.
2. MAX. PACKAGE WARPAGE IS 0.08 mm.
3. MAXIMUM ALLOWABLE BURRS IS 0.076 mm IN ALL DIRECTIONS.
4. PIN #1 ID WILL BE LASER MARKED.

**10-Pin 2.5mm x 2.5mm Thin MLF<sup>®</sup>**

## Recommended Land Pattern

LP # **MLF2525D-10LD-LP-1**

All units are in mm

Tolerance  $\pm 0.05$  if not noted

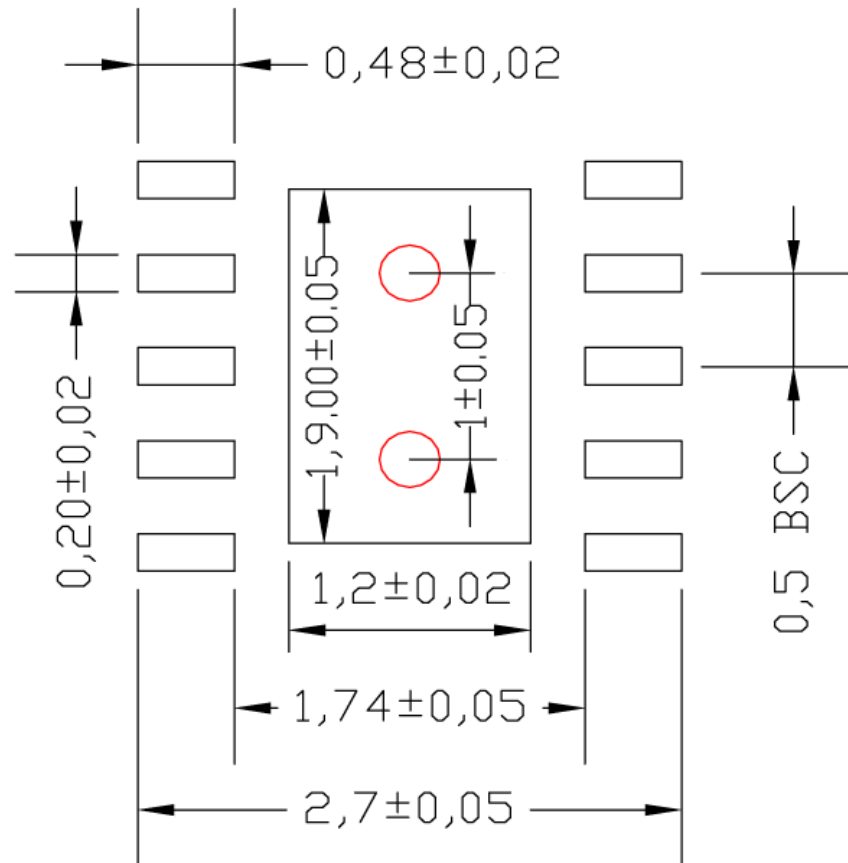

Red circle indicates Thermal Via. Size should be .300-.350 mm in diameter and it should be connected to GND plane for maximum thermal performance.

**MICREL, INC. 2180 FORTUNE DRIVE SAN JOSE, CA 95131 USA**

TEL +1 (408) 944-0800 FAX +1 (408) 474-1000 WEB <http://www.micrel.com>

Micrel makes no representations or warranties with respect to the accuracy or completeness of the information furnished in this data sheet. This information is not intended as a warranty and Micrel does not assume responsibility for its use. Micrel reserves the right to change circuitry, specifications and descriptions at any time without notice. No license, whether express, implied, arising by estoppel or otherwise, to any intellectual property rights is granted by this document. Except as provided in Micrel's terms and conditions of sale for such products, Micrel assumes no liability whatsoever, and Micrel disclaims any express or implied warranty relating to the sale and/or use of Micrel products including liability or warranties relating to fitness for a particular purpose, merchantability, or infringement of any patent, copyright or other intellectual property right.

Micrel Products are not designed or authorized for use as components in life support appliances, devices or systems where malfunction of a product can reasonably be expected to result in personal injury. Life support devices or systems are devices or systems that (a) are intended for surgical implant into the body or (b) support or sustain life, and whose failure to perform can be reasonably expected to result in a significant injury to the user. A Purchaser's use or sale of Micrel Products for use in life support appliances, devices or systems is a Purchaser's own risk and Purchaser agrees to fully indemnify Micrel for any damages resulting from such use or sale.

© 2009 Micrel, Incorporated.

# Mouser Electronics

Authorized Distributor

Click to View Pricing, Inventory, Delivery & Lifecycle Information:

[Micrel:](#)

[MIC23153-GYMT-TR](#) [MIC23153YMT-TR](#)



Компания «ЭлектроПласт» предлагает заключение долгосрочных отношений при поставках импортных электронных компонентов на взаимовыгодных условиях!

Наши преимущества:

- Оперативные поставки широкого спектра электронных компонентов отечественного и импортного производства напрямую от производителей и с крупнейших мировых складов;
- Поставка более 17-ти миллионов наименований электронных компонентов;
- Поставка сложных, дефицитных, либо снятых с производства позиций;
- Оперативные сроки поставки под заказ (от 5 рабочих дней);
- Экспресс доставка в любую точку России;
- Техническая поддержка проекта, помощь в подборе аналогов, поставка прототипов;
- Система менеджмента качества сертифицирована по Международному стандарту ISO 9001;
- Лицензия ФСБ на осуществление работ с использованием сведений, составляющих государственную тайну;
- Поставка специализированных компонентов (Xilinx, Altera, Analog Devices, Intersil, Interpoint, Microsemi, Aeroflex, Peregrine, Syfer, Eurofarad, Texas Instrument, Miteq, Cobham, E2V, MA-COM, Hittite, Mini-Circuits, General Dynamics и др.);

Помимо этого, одним из направлений компании «ЭлектроПласт» является направление «Источники питания». Мы предлагаем Вам помощь Конструкторского отдела:

- Подбор оптимального решения, техническое обоснование при выборе компонента;
- Подбор аналогов;
- Консультации по применению компонента;
- Поставка образцов и прототипов;
- Техническая поддержка проекта;
- Защита от снятия компонента с производства.



#### Как с нами связаться

**Телефон:** 8 (812) 309 58 32 (многоканальный)

**Факс:** 8 (812) 320-02-42

**Электронная почта:** [org@eplast1.ru](mailto:org@eplast1.ru)

**Адрес:** 198099, г. Санкт-Петербург, ул. Калинина, дом 2, корпус 4, литера А.