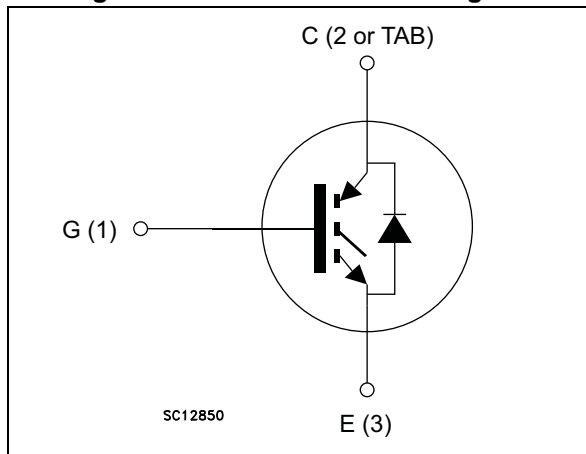

Figure 1. Internal schematic diagram



### Features

- Designed for soft commutation only
- Maximum junction temperature:  $T_J = 175\text{ }^\circ\text{C}$
- Tail-less switching off
- $V_{CE(sat)} = 1.8\text{ V (typ.) @ } I_C = 40\text{ A}$
- Tight parameters distribution
- Safe paralleling
- Low thermal resistance
- Low  $V_F$  soft recovery co-packaged diode

### Applications

- Induction heating
- Microwave oven
- Resonant converters

### Description

This device is an IGBT developed using an advanced proprietary trench gate field stop structure. The device is part of the V series of IGBTs, which represent an optimum compromise between conduction and switching losses to maximize the efficiency of very high frequency converters. Furthermore, a positive  $V_{CE(sat)}$  temperature coefficient and very tight parameter distribution result in safer paralleling operation.

Table 1. Device summary

| Order code    | Marking     | Package | Packaging |
|---------------|-------------|---------|-----------|
| STGW40V60DLF  | GW40V60DLF  | TO-247  | Tube      |
| STGWT40V60DLF | GWT40V60DLF | TO-3P   | Tube      |

# Contents

|          |   |           |
|----------|---|-----------|
| <b>1</b> | <b>Electrical ratings</b> .....           | <b>3</b>  |
| <b>2</b> | <b>Electrical characteristics</b> .....   | <b>4</b>  |
| 2.1      | Electrical characteristics (curves) ..... | 6         |
| <b>3</b> | <b>Test circuits</b> .....                | <b>11</b> |
| <b>4</b> | <b>Package mechanical data</b> .....      | <b>12</b> |
| <b>5</b> | <b>Revision history</b> .....             | <b>16</b> |

# 1 Electrical ratings

**Table 2. Absolute maximum ratings**

| Symbol         | Parameter   | Value       | Unit |
|----------------|---|-------------|------|
| $V_{CES}$      | Collector-emitter voltage ( $V_{GE} = 0$ )            | 600         | V    |
| $I_C$          | Continuous collector current at $T_C = 25\text{ °C}$  | 80          | A    |
| $I_C$          | Continuous collector current at $T_C = 100\text{ °C}$ | 40          | A    |
| $I_{CP}^{(1)}$ | Pulsed collector current                              | 160         | A    |
| $V_{GE}$       | Gate-emitter voltage                                  | $\pm 20$    | V    |
| $I_F$          | Continuous forward current at $T_C = 25\text{ °C}$    | 80          | A    |
| $I_F$          | Continuous forward current at $T_C = 100\text{ °C}$   | 40          | A    |
| $I_{FP(1)}$    | Pulsed forward current                                | 160         | A    |
| $P_{TOT}$      | Total dissipation at $T_C = 25\text{ °C}$             | 283         | W    |
| $T_{STG}$      | Storage temperature range                             | - 55 to 150 | °C   |
| $T_J$          | Operating junction temperature                        | - 55 to 175 | °C   |

1. Pulse width limited by maximum junction temperature

**Table 3. Thermal data**

| Symbol     | Parameter                              | Value | Unit |
|------------|--|-------|------|
| $R_{thJC}$ | Thermal resistance junction-case IGBT  | 0.53  | °C/W |
| $R_{thJC}$ | Thermal resistance junction-case diode | 1.4   | °C/W |
| $R_{thJA}$ | Thermal resistance junction-ambient    | 50    | °C/W |

## 2 Electrical characteristics

$T_J = 25\text{ °C}$  unless otherwise specified.

**Table 4. Static characteristics**

| Symbol        | Parameter  | Test conditions  | Min. | Typ. | Max. | Unit          |
|---------------|--|--|------|------|------|---------------|
| $V_{(BR)CES}$ | Collector-emitter breakdown voltage ( $V_{GE} = 0$ ) | $I_C = 2\text{ mA}$  | 600  |      |      | V             |
| $V_{CE(sat)}$ | Collector-emitter saturation voltage                 | $V_{GE} = 15\text{ V}, I_C = 40\text{ A}$                          |      | 1.8  | 2.3  | V             |
|               |  | $V_{GE} = 15\text{ V}, I_C = 40\text{ A}$<br>$T_J = 125\text{ °C}$ |      | 2.15 |      |               |
|               |  | $V_{GE} = 15\text{ V}, I_C = 40\text{ A}$<br>$T_J = 175\text{ °C}$ |      | 2.35 |      |               |
| $V_F$         | Forward on-voltage                                   | $I_F = 40\text{ A}$  |      | 1.55 | 1.8  | V             |
|               |  | $I_F = 40\text{ A}, T_J = 125\text{ °C}$                           |      | 1.3  |      | V             |
|               |  | $I_F = 40\text{ A}, T_J = 175\text{ °C}$                           |      | 1.25 |      | V             |
| $V_{GE(th)}$  | Gate threshold voltage                               | $V_{CE} = V_{GE}, I_C = 1\text{ mA}$                               | 5    | 6    | 7    | V             |
| $I_{CES}$     | Collector cut-off current ( $V_{GE} = 0$ )           | $V_{CE} = 600\text{ V}$  |      |      | 25   | $\mu\text{A}$ |
| $I_{GES}$     | Gate-emitter leakage current ( $V_{CE} = 0$ )        | $V_{GE} = \pm 20\text{ V}$   |      |      | 250  | nA            |

**Table 5. Dynamic characteristics**

| Symbol    | Parameter                    | Test conditions  | Min. | Typ. | Max. | Unit |
|-----------|------------------------------|--|------|------|------|------|
| $C_{ies}$ | Input capacitance            | $V_{CE} = 25\text{ V}, f = 1\text{ MHz},$<br>$V_{GE} = 0$  | -    | 5400 | -    | pF   |
| $C_{oes}$ | Output capacitance           |  | -    | 220  | -    | pF   |
| $C_{res}$ | Reverse transfer capacitance |  | -    | 180  | -    | pF   |
| $Q_g$     | Total gate charge            | $V_{CC} = 480\text{ V}, I_C = 40\text{ A},$<br>$V_{GE} = 15\text{ V}$ (see <a href="#">Figure 27</a> ) | -    | 226  | -    | nC   |
| $Q_{ge}$  | Gate-emitter charge          |  | -    | 38   | -    | nC   |
| $Q_{gc}$  | Gate-collector charge        |  | -    | 95   | -    | nC   |

Table 6. IGBT switching characteristics (inductive load)

| Symbol          | Parameter                 | Test conditions  | Min. | Typ. | Max. | Unit          |
|-----------------|---------------------------|--|------|------|------|---------------|
| $t_{d(off)}$    | Turn-off delay time       | $V_{CE} = 400\text{ V}$ , $I_C = 40\text{ A}$ ,<br>$R_G = 10\ \Omega$ , $V_{GE} = 15\text{ V}$<br>(see <a href="#">Figure 25</a> )                                     |      | 208  |      | ns            |
| $t_f$           | Current fall time         |  | -    | 20   | -    | ns            |
| $E_{off}^{(1)}$ | Turn-off switching losses |  | -    | 411  | -    | $\mu\text{J}$ |
| $t_{d(off)}$    | Turn-off delay time       | $V_{CE} = 400\text{ V}$ , $I_C = 40\text{ A}$ ,<br>$R_G = 10\ \Omega$ , $V_{GE} = 15\text{ V}$ ,<br>$T_J = 175\text{ }^\circ\text{C}$ (see <a href="#">Figure 25</a> ) |      | 220  |      | ns            |
| $t_f$           | Current fall time         |  | -    | 21   | -    | ns            |
| $E_{off}^{(1)}$ | Turn-off switching losses |  | -    | 560  | -    | $\mu\text{J}$ |

1. Turn-off losses include also the tail of the collector current.

Table 7. IGBT switching characteristics (capacitive load)

| Symbol          | Parameter                 | Test conditions   | Min. | Typ. | Max. | Unit          |
|-----------------|---------------------------|---|------|------|------|---------------|
| $E_{off}^{(1)}$ | Turn-off switching losses | $V_{CC} = 320\text{ V}$ , $R_G = 10\ \Omega$ ,<br>$I_C = 40\text{ A}$ , $L = 100\ \mu\text{H}$ ,<br>$C_{snub} = 20\text{ nF}$<br>(see <a href="#">Figure 26</a> )                                     | -    | 147  | -    | $\mu\text{J}$ |
|                 |                           | $V_{CC} = 320\text{ V}$ , $R_G = 10\ \Omega$ ,<br>$I_C = 40\text{ A}$ , $L = 100\ \mu\text{H}$ ,<br>$C_{snub} = 20\text{ nF}$ , $T_J = 175\text{ }^\circ\text{C}$<br>(see <a href="#">Figure 26</a> ) | -    | 303  | -    |               |

1. Turn-off losses include also the tail of the collector current.

## 2.1 Electrical characteristics (curves)

Figure 2. Power dissipation vs. case temperature

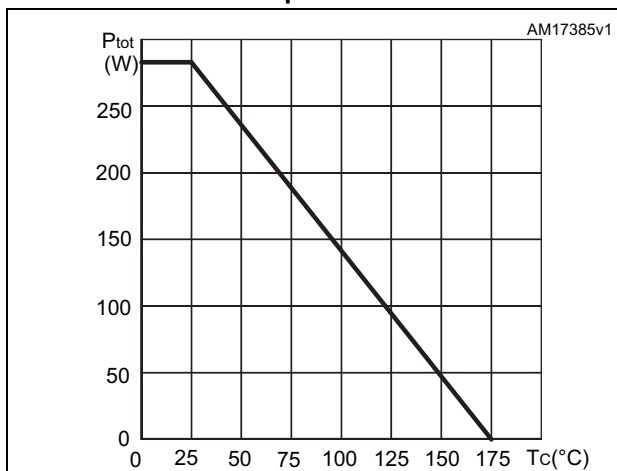

Figure 3. Collector current vs. case temperature

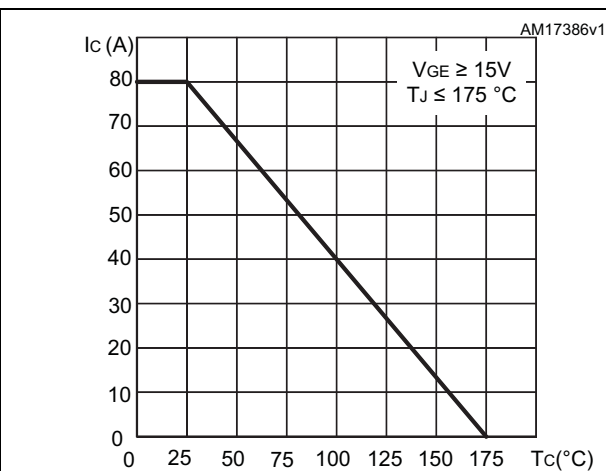

Figure 4. Output characteristics (Tj=25°C)

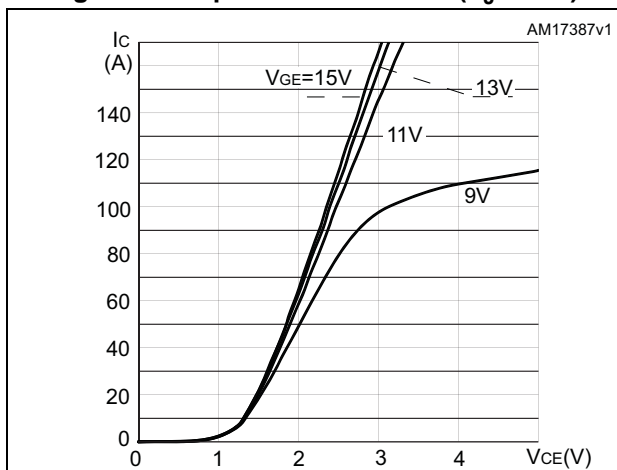

Figure 5. Output characteristics (Tj=175°C)

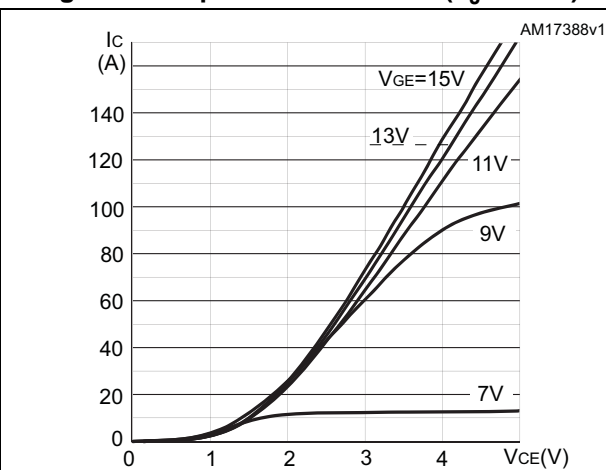

Figure 6. VCE(sat) vs. junction temperature

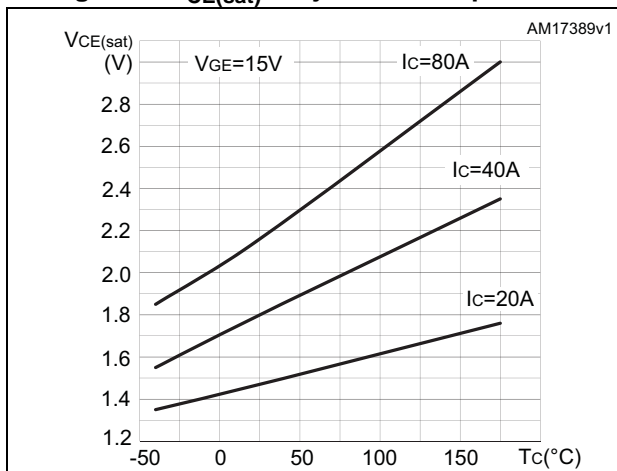

Figure 7. VCE(sat) vs. collector current

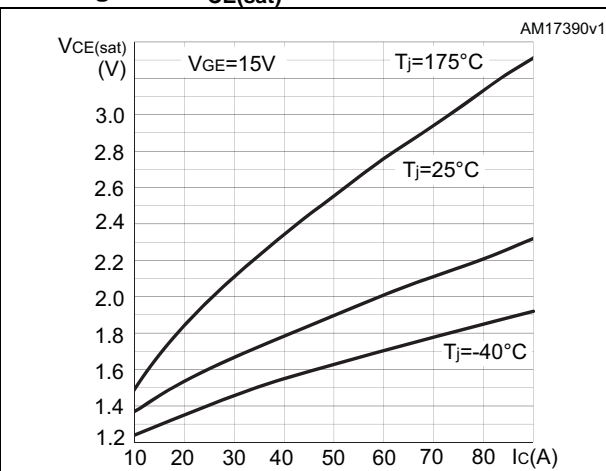

Figure 8. Collector current vs. switching frequency

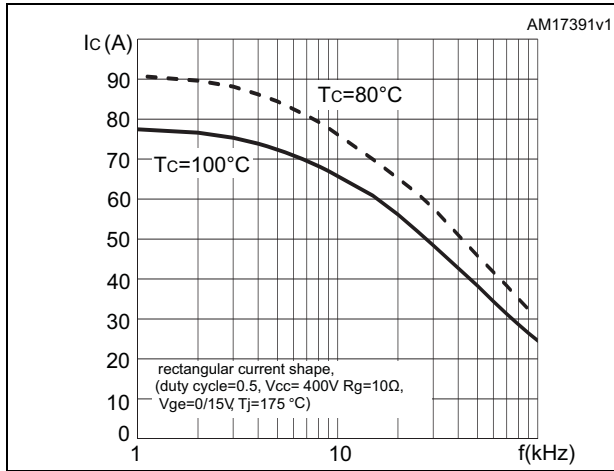

Figure 9. Forward bias safe operating area

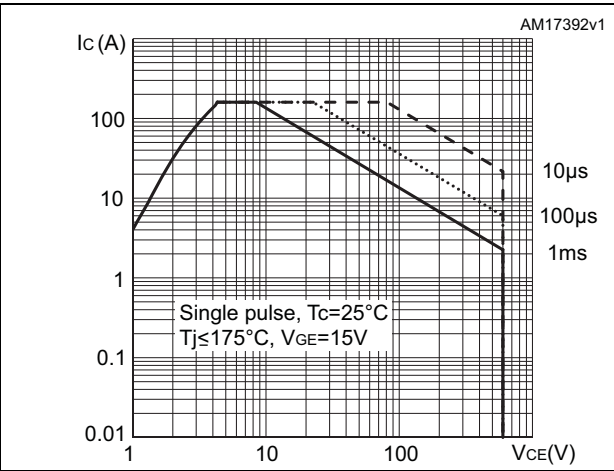

Figure 10. Transfer characteristics

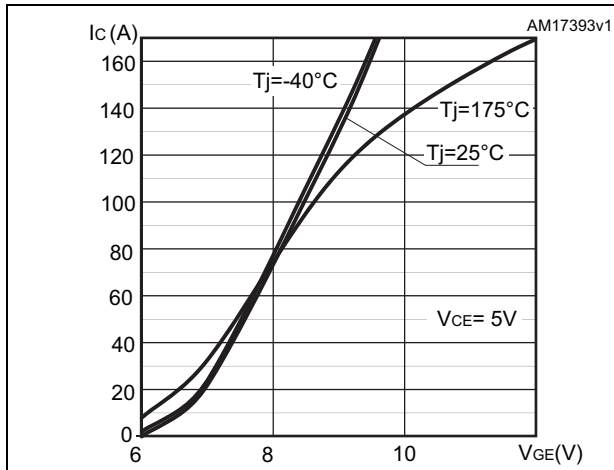

Figure 11. Diode V\_F vs. forward current

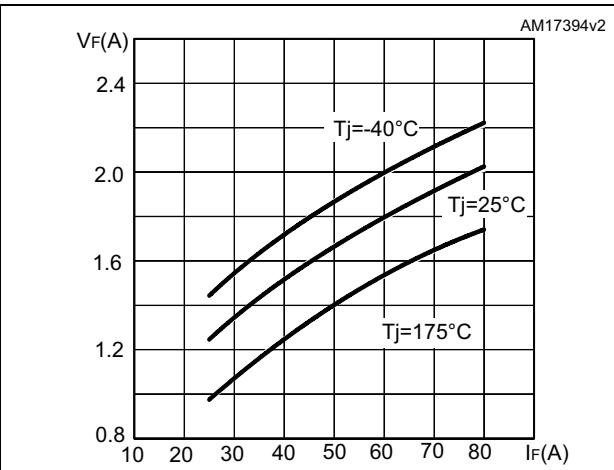

Figure 12. Normalized  $V_{GE(th)}$  vs junction temperature

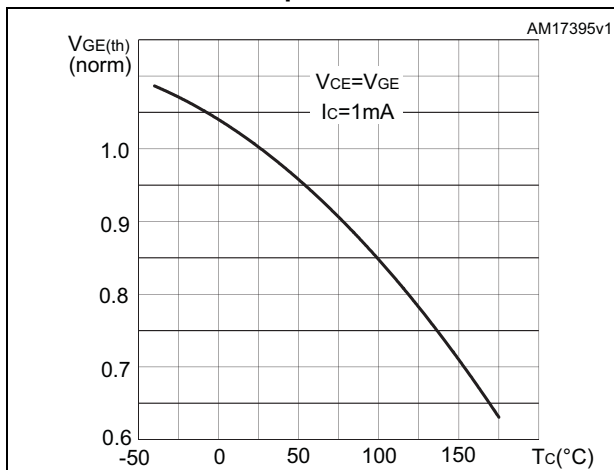

Figure 13. Normalized  $V_{(BR)CES}$  vs. junction temperature

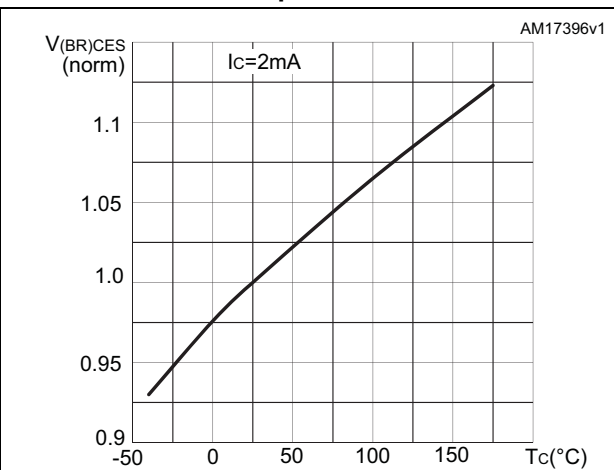

Figure 14. Capacitance variations

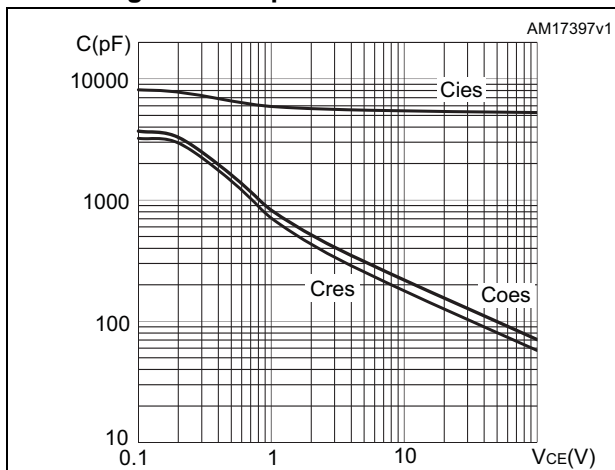

Figure 15. Gate charge vs. gate-emitter voltage

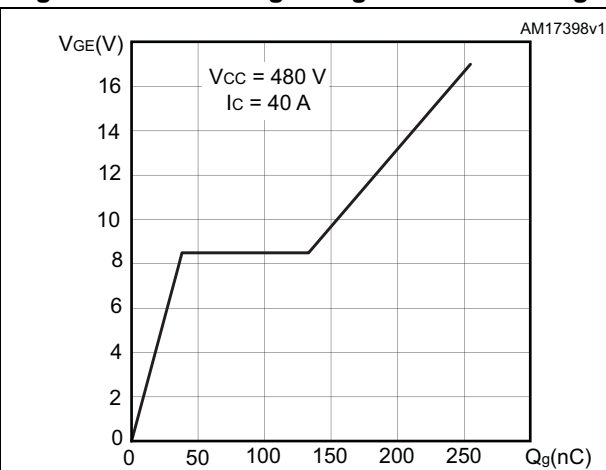

Figure 16. Switching-off losses vs. collector current

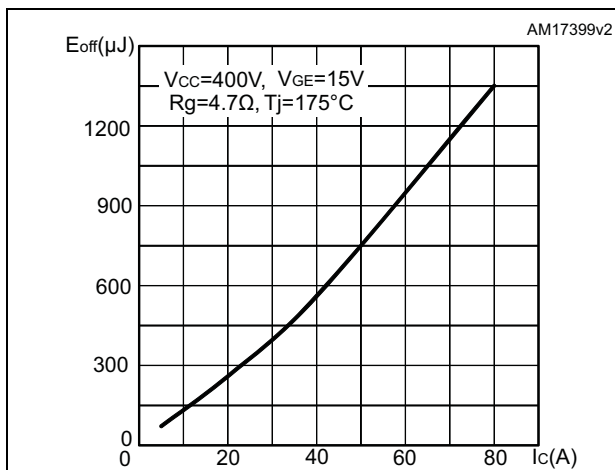

Figure 17. Switching-off losses vs. gate resistance

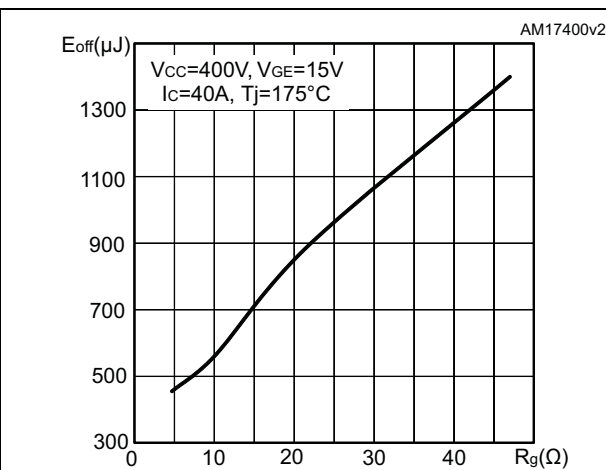

Figure 18. Switching-off losses vs. junction temperature

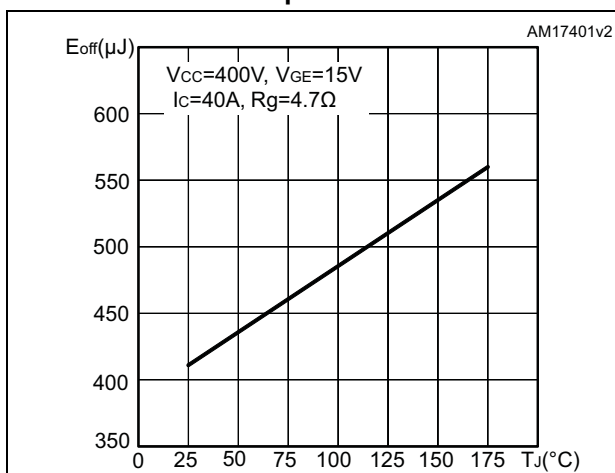

Figure 19. Switching-off losses vs. collector emitter voltage

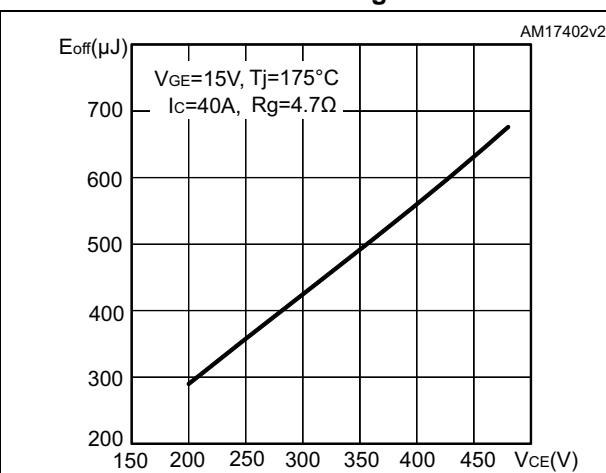



Figure 20. Switching times vs. collector current

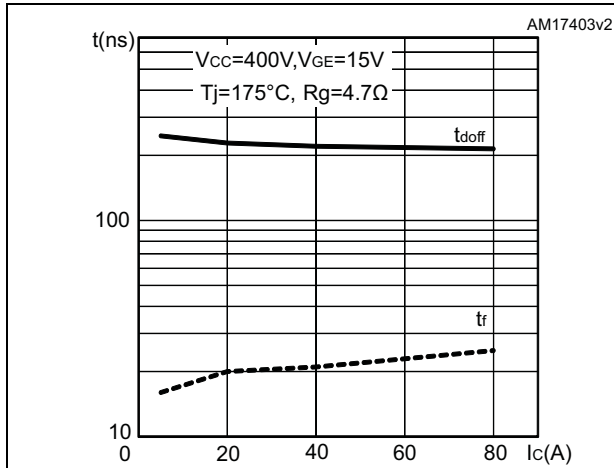

Figure 21. Switching times vs. gate resistance

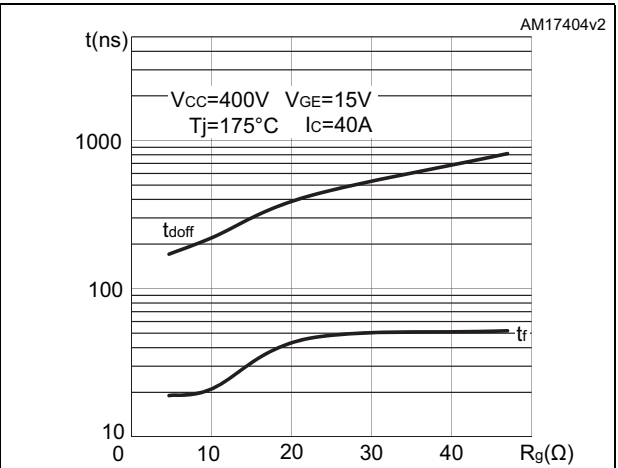

Figure 22. Switching-off losses vs. capacitive load

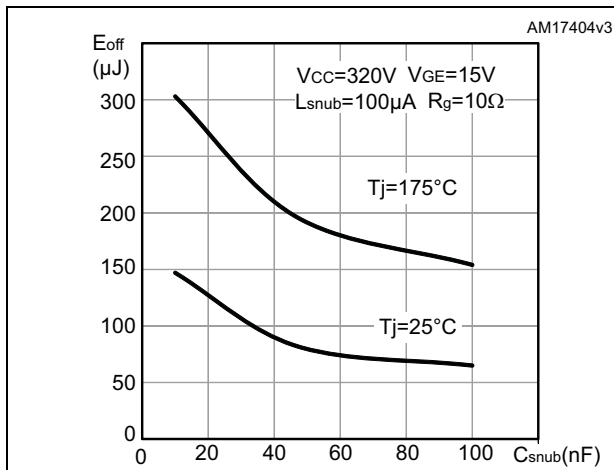

Figure 23. Thermal data for IGBT

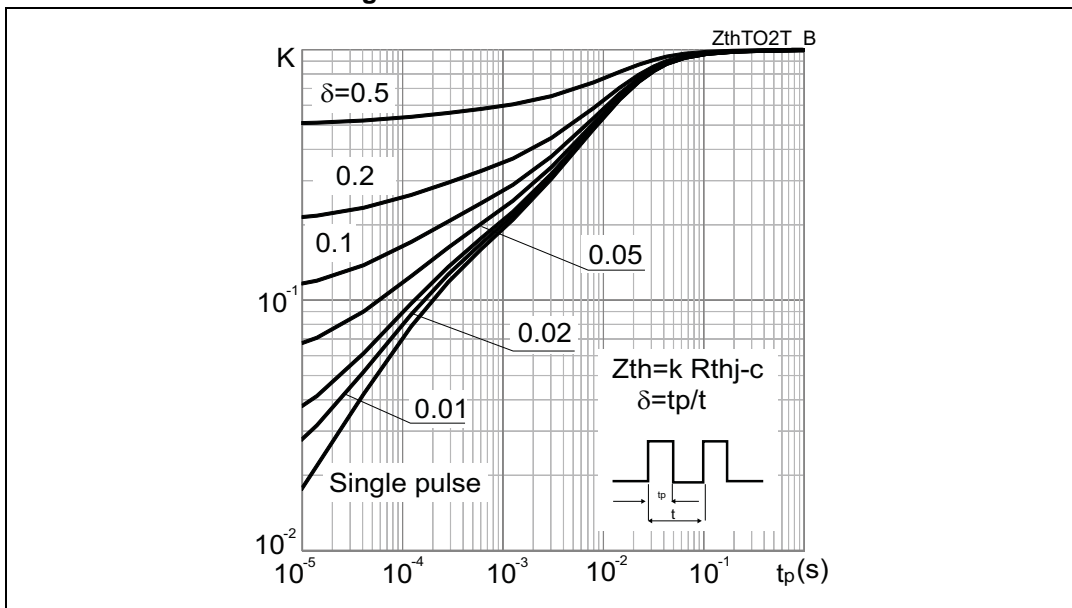
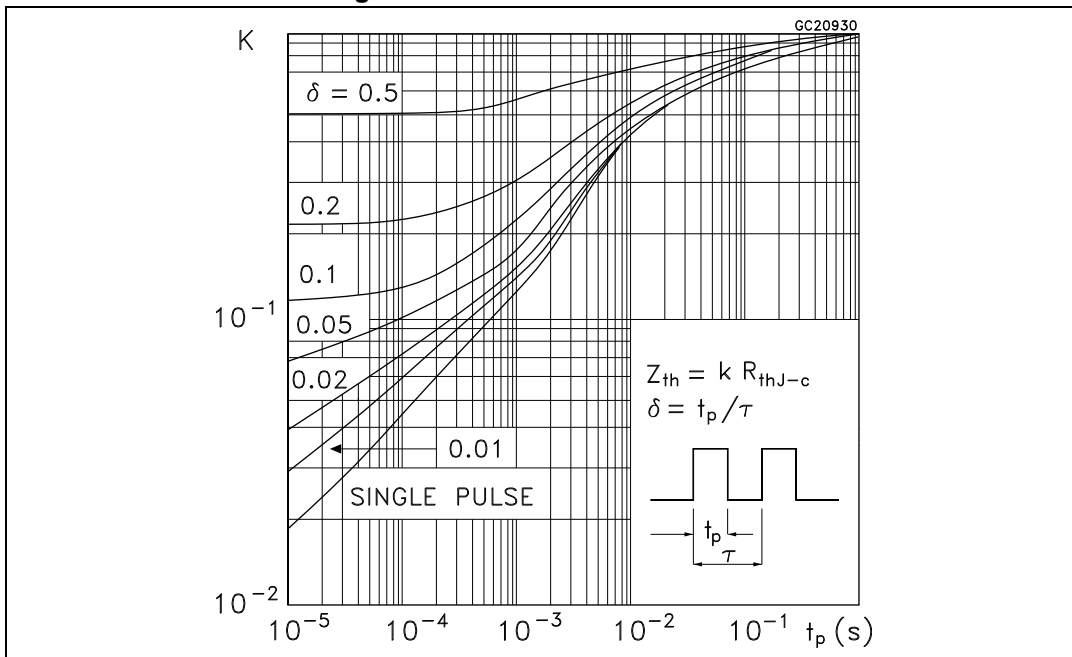

Figure 24. Thermal data for diode



### 3 Test circuits

Figure 25. Test circuit for inductive load switching



Figure 26. Test circuit for capacitive load switching

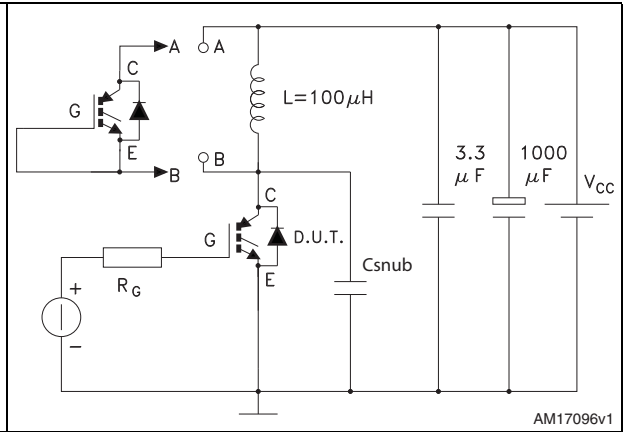

Figure 27. Gate charge test circuit



Figure 28. Switching waveform



Figure 29. Diode recovery time waveform



## 4 Package mechanical data

In order to meet environmental requirements, ST offers these devices in different grades of ECOPACK® packages, depending on their level of environmental compliance. ECOPACK® specifications, grade definitions and product status are available at: [www.st.com](http://www.st.com). ECOPACK is an ST trademark.

**Table 8. TO-247 mechanical data**

| Dim. | mm.   |       |       |
|------|-------|-------|-------|
|      | Min.  | Typ.  | Max.  |
| A    | 4.85  |       | 5.15  |
| A1   | 2.20  |       | 2.60  |
| b    | 1.0   |       | 1.40  |
| b1   | 2.0   |       | 2.40  |
| b2   | 3.0   |       | 3.40  |
| c    | 0.40  |       | 0.80  |
| D    | 19.85 |       | 20.15 |
| E    | 15.45 |       | 15.75 |
| e    | 5.30  | 5.45  | 5.60  |
| L    | 14.20 |       | 14.80 |
| L1   | 3.70  |       | 4.30  |
| L2   |       | 18.50 |       |
| ØP   | 3.55  |       | 3.65  |
| ØR   | 4.50  |       | 5.50  |
| S    | 5.30  | 5.50  | 5.70  |

Figure 30. TO-247 drawing

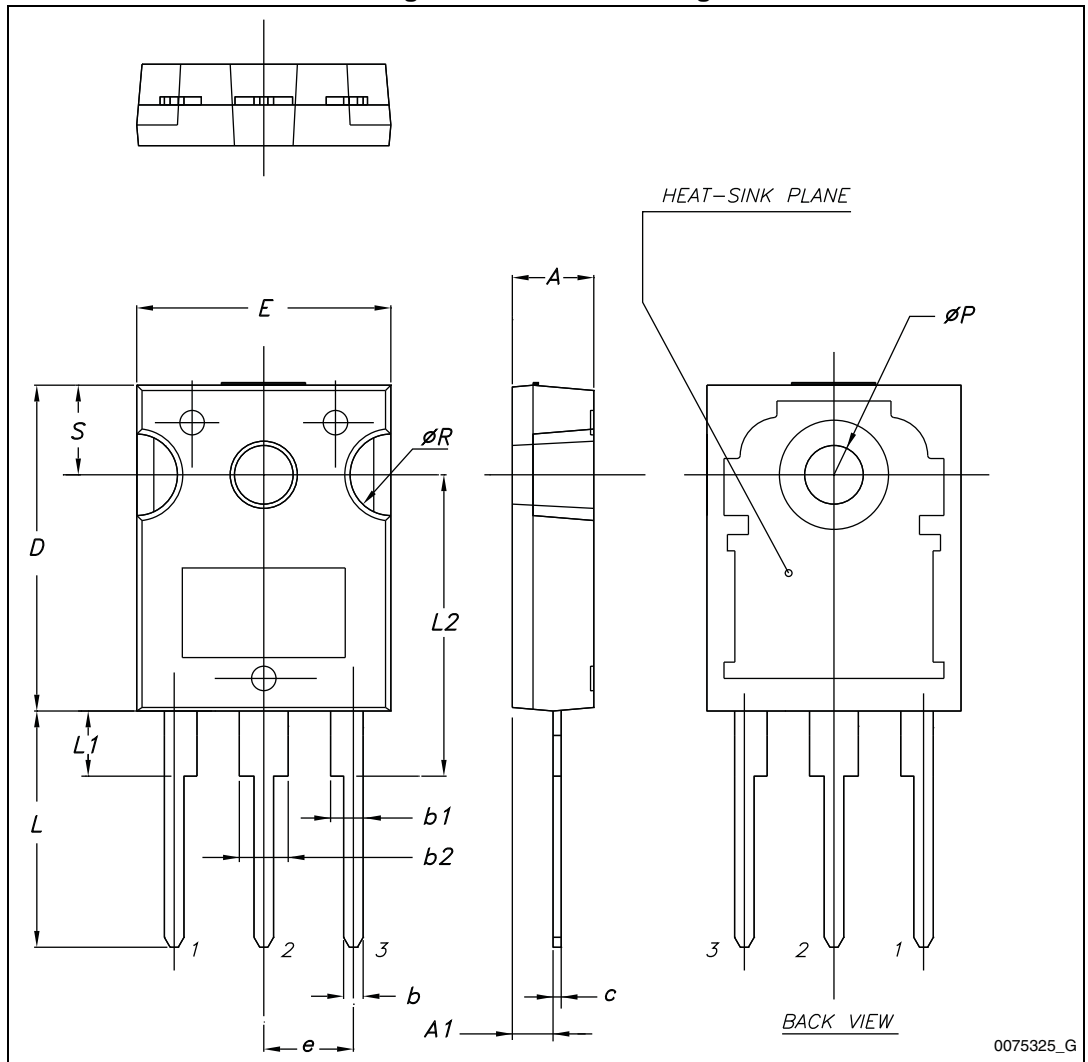
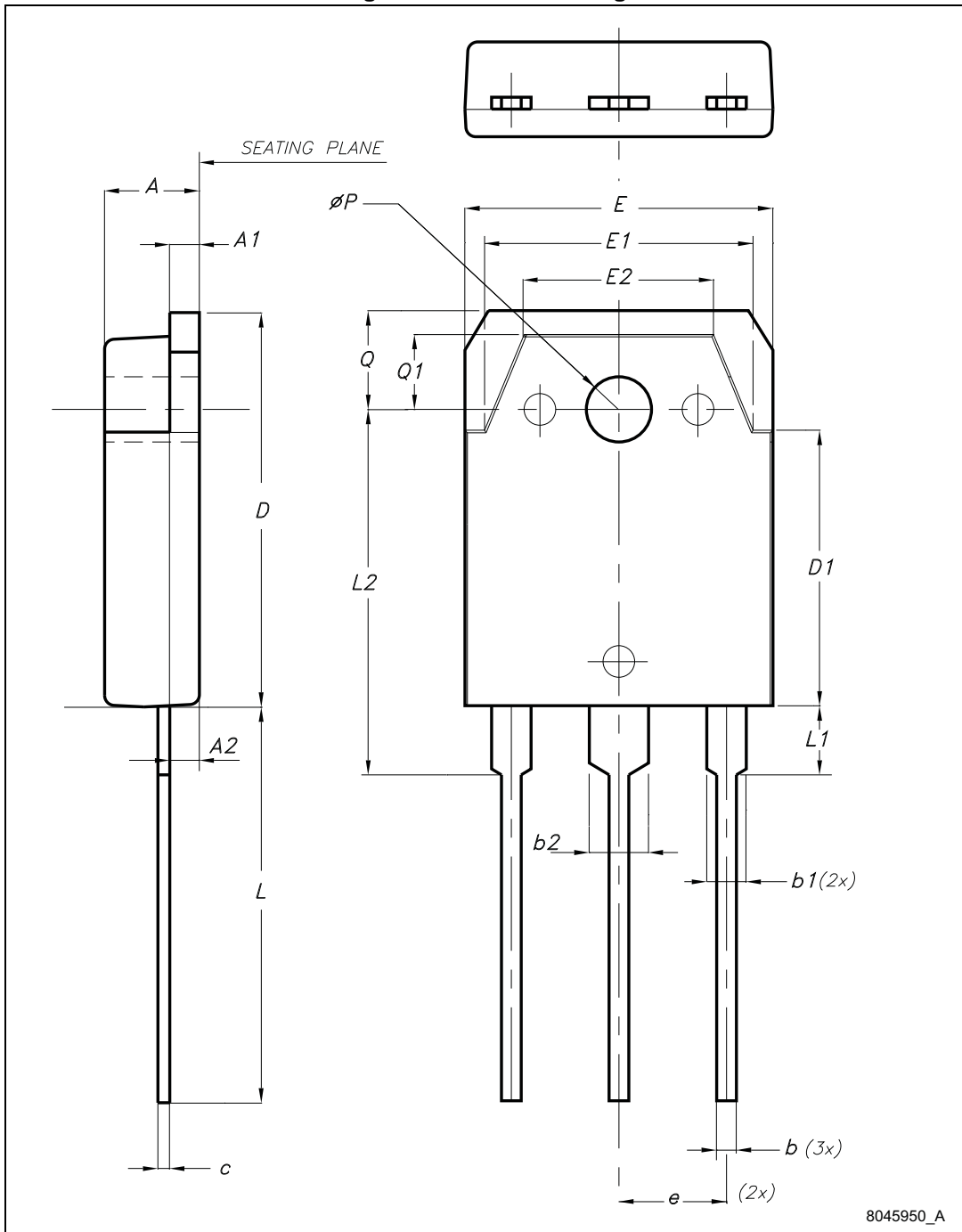

Table 9. TO-3P mechanical data

| Dim. | mm    |       |       |
|------|-------|-------|-------|
|      | Min.  | Typ.  | Max.  |
| A    | 4.60  |       | 5     |
| A1   | 1.45  | 1.50  | 1.65  |
| A2   | 1.20  | 1.40  | 1.60  |
| b    | 0.80  | 1     | 1.20  |
| b1   | 1.80  |       | 2.20  |
| b2   | 2.80  |       | 3.20  |
| c    | 0.55  | 0.60  | 0.75  |
| D    | 19.70 | 19.90 | 20.10 |
| D1   |       | 13.90 |       |
| E    | 15.40 |       | 15.80 |
| E1   |       | 13.60 |       |
| E2   |       | 9.60  |       |
| e    | 5.15  | 5.45  | 5.75  |
| L    | 19.50 | 20    | 20.50 |
| L1   |       | 3.50  |       |
| L2   | 18.20 | 18.40 | 18.60 |
| øP   | 3.10  |       | 3.30  |
| Q    |       | 5     |       |
| Q1   |       | 3.80  |       |

Figure 31. TO-3P drawing



8045950\_A

## 5 Revision history

Table 10. Document revision history

| Date        | Revision | Changes   |
|-------------|----------|---|
| 07-Feb-2013 | 1        | Initial release.  |
| 17-Jun-2013 | 2        | Document status promoted from preliminary to production data.   |
| 01-Jul-2013 | 3        | Updated <a href="#">Section 2.1: Electrical characteristics (curves)</a> and <a href="#">Section Table 7.: IGBT switching characteristics (capacitive load)</a> |
| 21-Oct-2013 | 4        | Updated title, features and description in cover page.  |



**Please Read Carefully:**

Information in this document is provided solely in connection with ST products. STMicroelectronics NV and its subsidiaries ("ST") reserve the right to make changes, corrections, modifications or improvements, to this document, and the products and services described herein at any time, without notice.

All ST products are sold pursuant to ST's terms and conditions of sale.

Purchasers are solely responsible for the choice, selection and use of the ST products and services described herein, and ST assumes no liability whatsoever relating to the choice, selection or use of the ST products and services described herein.

No license, express or implied, by estoppel or otherwise, to any intellectual property rights is granted under this document. If any part of this document refers to any third party products or services it shall not be deemed a license grant by ST for the use of such third party products or services, or any intellectual property contained therein or considered as a warranty covering the use in any manner whatsoever of such third party products or services or any intellectual property contained therein.

**UNLESS OTHERWISE SET FORTH IN ST'S TERMS AND CONDITIONS OF SALE ST DISCLAIMS ANY EXPRESS OR IMPLIED WARRANTY WITH RESPECT TO THE USE AND/OR SALE OF ST PRODUCTS INCLUDING WITHOUT LIMITATION IMPLIED WARRANTIES OF MERCHANTABILITY, FITNESS FOR A PARTICULAR PURPOSE (AND THEIR EQUIVALENTS UNDER THE LAWS OF ANY JURISDICTION), OR INFRINGEMENT OF ANY PATENT, COPYRIGHT OR OTHER INTELLECTUAL PROPERTY RIGHT.**

**ST PRODUCTS ARE NOT DESIGNED OR AUTHORIZED FOR USE IN: (A) SAFETY CRITICAL APPLICATIONS SUCH AS LIFE SUPPORTING, ACTIVE IMPLANTED DEVICES OR SYSTEMS WITH PRODUCT FUNCTIONAL SAFETY REQUIREMENTS; (B) AERONAUTIC APPLICATIONS; (C) AUTOMOTIVE APPLICATIONS OR ENVIRONMENTS, AND/OR (D) AEROSPACE APPLICATIONS OR ENVIRONMENTS. WHERE ST PRODUCTS ARE NOT DESIGNED FOR SUCH USE, THE PURCHASER SHALL USE PRODUCTS AT PURCHASER'S SOLE RISK, EVEN IF ST HAS BEEN INFORMED IN WRITING OF SUCH USAGE, UNLESS A PRODUCT IS EXPRESSLY DESIGNATED BY ST AS BEING INTENDED FOR "AUTOMOTIVE, AUTOMOTIVE SAFETY OR MEDICAL" INDUSTRY DOMAINS ACCORDING TO ST PRODUCT DESIGN SPECIFICATIONS. PRODUCTS FORMALLY ESCC, QML OR JAN QUALIFIED ARE DEEMED SUITABLE FOR USE IN AEROSPACE BY THE CORRESPONDING GOVERNMENTAL AGENCY.**

Resale of ST products with provisions different from the statements and/or technical features set forth in this document shall immediately void any warranty granted by ST for the ST product or service described herein and shall not create or extend in any manner whatsoever, any liability of ST.

ST and the ST logo are trademarks or registered trademarks of ST in various countries.

Information in this document supersedes and replaces all information previously supplied.

The ST logo is a registered trademark of STMicroelectronics. All other names are the property of their respective owners.

© 2013 STMicroelectronics - All rights reserved

STMicroelectronics group of companies

Australia - Belgium - Brazil - Canada - China - Czech Republic - Finland - France - Germany - Hong Kong - India - Israel - Italy - Japan - Malaysia - Malta - Morocco - Philippines - Singapore - Spain - Sweden - Switzerland - United Kingdom - United States of America

[www.st.com](http://www.st.com)





Компания «ЭлектроПласт» предлагает заключение долгосрочных отношений при поставках импортных электронных компонентов на взаимовыгодных условиях!

Наши преимущества:

- Оперативные поставки широкого спектра электронных компонентов отечественного и импортного производства напрямую от производителей и с крупнейших мировых складов;
- Поставка более 17-ти миллионов наименований электронных компонентов;
- Поставка сложных, дефицитных, либо снятых с производства позиций;
- Оперативные сроки поставки под заказ (от 5 рабочих дней);
- Экспресс доставка в любую точку России;
- Техническая поддержка проекта, помощь в подборе аналогов, поставка прототипов;
- Система менеджмента качества сертифицирована по Международному стандарту ISO 9001;
- Лицензия ФСБ на осуществление работ с использованием сведений, составляющих государственную тайну;
- Поставка специализированных компонентов (Xilinx, Altera, Analog Devices, Intersil, Interpoint, Microsemi, Aeroflex, Peregrine, Syfer, Eurofarad, Texas Instrument, Miteq, Cobham, E2V, MA-COM, Hittite, Mini-Circuits, General Dynamics и др.);

Помимо этого, одним из направлений компании «ЭлектроПласт» является направление «Источники питания». Мы предлагаем Вам помощь Конструкторского отдела:

- Подбор оптимального решения, техническое обоснование при выборе компонента;
- Подбор аналогов;
- Консультации по применению компонента;
- Поставка образцов и прототипов;
- Техническая поддержка проекта;
- Защита от снятия компонента с производства.



#### Как с нами связаться

**Телефон:** 8 (812) 309 58 32 (многоканальный)

**Факс:** 8 (812) 320-02-42

**Электронная почта:** [org@eplast1.ru](mailto:org@eplast1.ru)

**Адрес:** 198099, г. Санкт-Петербург, ул. Калинина, дом 2, корпус 4, литера А.