

## TABLE OF CONTENTS



General, 4

### STANDARD *page 12*

Straight-Through



Polyamide, 16      Brass, Nickel Plated, 17

Other Functions



Bend, 18      Pull / Bend, 19      Multi-Conductor, 20      Flat Cable, 21

### HIGH PERFORMANCE *page 22*

Straight-Through



Polyamide, 28      PVDF, 30      Brass, Nickel Plated, 32      Stainless Steel, 34

Other Functions



Increased Strain, 36      Bend, 38      Pull / Bend, 40      Multi-Conductor, 42      EMI / RFI, 47      Flat Cable, 48

### ECONOMY *page 50*

Straight-Through



Polystyrene, 51      Brass, Nickel Plated, 51

### ACCESSORIES *page 52*



Seal Rings, 52      Sealing Plugs, 52      Socket Wrenches, 53      Locknuts, 54

#### TECHNICAL INFORMATION

International Protection (IP) Codes	6	Possible Combinations of Body and Sealing Materials by Function	8 and 9
NEMA / IP Cross Reference	6	Index	57-59
Chemical Resistance	7	Terms and Conditions	61
Selection Criteria	7	Fax Back	62

# General Information

Liquid Tight Strain Reliefs (Cord Grips) serve two main purposes:

- A. Seal cable entries and keep contaminants from entering into enclosures.**
- B. Provide strain relief to reduce stress on components and termination points mounted inside of enclosures.**

Altech offers three Liquid Tight Strain Relief Series:

## Standard

Offering an excellent price / performance ratio. Suitable for most applications. Widely used.

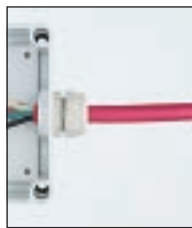

1. Straight-Through

## High Performance

Excellent for demanding applications, special requirements, and tough environmental conditions.



2. Increased Strain

## Economy

Suitable for basic applications.



3. Bend Protection

## Functions

Altech Cord Grips are available for a wide range of functions:

1. Straight-Through
2. Increased Strain Relief
3. Bend Protection
4. Pull / Bend Protection
5. Multi-Conductor
6. Flat Cable
7. EMI / RFI



4. Pull / Bend Protection

## PG and NPT Threads

Most Cord Grips are available with PG and NPT external threads. Metric sizes and extended length thread versions are available. Please consult Altech.

## Cable and Cord Types

Use Liquid Tight Strain Reliefs with almost any type of cable, cord or conductor – solid, stranded, flat, shielded, high temperature, etc.

## Wide Range of Materials

Altech provides Cord Grips in a wide range of Body and Sealing materials to meet difficult environmental conditions. Please see the next page for available materials, functions and protection ratings.

## Temperature Rating

Temperature ratings for Cord Grip materials of construction are listed throughout the catalog. Please see each ordering page for specific temperature ratings.

To determine the minimum / maximum usable temperature rating of any Cord Grip combination, compare the individual temperature rating of each component and use the rating of the component with the lesser temperature as the limiting factor.

## Ready for Installation

Cord Grips are supplied complete and ready to install.



5. Multi-Conductor



6. Flat Cable



7. EMI / RFI

## Accessories

Altech offers Locknuts, Seal Rings, Socket Wrenches and Sealing Plugs for Cord Grips. Order Locknuts and Seal Rings separately as required. Refer to pages 52 to 54 for more information.

## Technical Data

General technical data can be found on pages 5 through 10. Specific technical information can be found in the Intro Section for each product group and the ordering pages.

## How to Select Cord Grips

To properly select Altech Cord Grips, the following should be considered.

### Protection Rating

Determine the Protection Rating Required. Refer to Chart I "International Protection (IP) Codes" and Chart II "NEMA / IP Cross Reference" on page 6. Protection Ratings are listed in on each ordering page.

### Material

Select a Cord Grip that will withstand expected environmental conditions. Refer to Chart III, "Chemical Resistance" and Chart IV, "Selection Criteria" on page 7.

### Function

Refer to Chart V "Possible Combinations of Body and Sealing Materials by Function" on pages 8 and 9.

### Thread Definitions for Cord Grips

#### PG

Current European Standard. Large installed base, widely used. Use with PG Locknuts.

#### NPT

National Pipe Thread (US). Use with NPT Locknuts.

#### Metric

Future European Standard. Will be phased in for PG after 1998. Not commonly used at this time and not always readily available. Not shown in this catalog. Please contact Altech for availability.

## Standard, page 12

## High Performance, page 22

## Economy, page 50



Sealing Sleeve

### Body Materials

- Polyamide (PA)
- Brass, Nickel Plated (BN)

### Sealing Sleeve Material

- Neoprene (NE)

### Sealing Insert Material

- Multi-Conductor: PVC Polyvinylchloride (PV)
- Flat Cable: Neoprene (NE)

### Functions

- Straight-Through
- Pull / Bend
- Multi-Conductor
- Bend
- Flat Cable

### Protection Rating

Up to IP68  
(NEMA 1, 2, 3, 3R, 4, 4X, 5, 6, 12, 13)<sup>1</sup>



Tubular Sealing Insert

### Body Materials

- Polyamide (PA)
- PVDF Polyvinylidene (PO)
- Brass, Nickel Plated (BN)
- Stainless Steel (SS)

### Tubular Sealing Insert Materials

- PVC Polyvinylchloride (PV)
- Santoprene (ST)
- TPE Polyolefin (TP)
- Silicone (SI)

### Functions

- Straight-Through
- Pull / Bend
- Multi-Conductor
- Increased Strain Relief
- Bend
- Flat Cable
- EMI / RFI

### Protection Rating

Up to IP68  
(NEMA 1, 2, 3, 3R, 4, 4X, 5, 6, 12, 13)<sup>1</sup>

### Pressure Rating

Up to 10 Bar (140 psi)



Sealing Ring

### Body Materials

- Polystyrene (PS)
- Brass, Nickel Plated (BN)

### Sealing Ring Material

- Rubber (RU)

### Function

- Straight-Through

### Protection Rating

Up to IP55  
(NEMA 1, 2, 5, 12, 13)<sup>1</sup>

<sup>1</sup>Please refer to Chart I, IP Codes and Chart II, NEMA Codes on page 6.

## INSTALLATION

Liquid Tight Strain Reliefs can be installed into threaded or nonthreaded holes (order Locknuts separately for installation in nonthreaded holes). Locknuts are shown on the ordering pages for each product and on page 54. For Mounting Hole Diameters refer to the dimensional information on each ordering page. If installation is into threaded holes, please contact Altech for required Hole Diameters and tap sizes.

Once the Cord Grip is mounted, insert cable(s) or cord(s) and tighten the Pressure Nut or Pressure Dome.

For high density installation of Cord Grips, please refer to the Installation Worksheet on page 55 for minimum clearance distances. Socket Wrenches for installing Cord Grips are shown on page 53.

### Recommended Tightening Torques

- Use torque listed for Cord Grip installation in threaded or nonthreaded holes
- Use 2/3 of the listed torque to fasten Pressure Dome



②



③



④



⑤

### Recommended Tightening Torques

External Thread	Recommended Tightening Torques	
	Metal Nm (lbin)	Nonmetallic Nm (lbin)
PG7	6.25 (55.31)	2.50 (22.12)
PG9	6.25 (55.31)	3.75 (33.19)
PG11	6.25 (55.31)	3.75 (33.19)
PG13.5	6.25 (55.31)	3.75 (33.19)
PG16	7.50 (66.37)	5.00 (44.25)
PG21	10.00 (88.50)	7.50 (66.37)
PG29	10.00 (88.50)	7.50 (66.37)
PG36	10.00 (88.50)	7.50 (66.37)
PG42	10.00 (88.50)	7.50 (66.37)
PG48	10.00 (88.50)	7.50 (66.37)
NPT3/8	6.25 (55.31)	3.75 (33.19)
NPT1/2	6.25 (55.31)	3.75 (33.19)
NPT3/4	10.00 (88.50)	7.50 (66.37)

# CHART I

## International Protection (IP) Ratings to IEC 529

First digit of IP Number - Ingress of foreign objects			Second digit of IP Number - Ingress of water								
			IP 0	IP 1	IP 2	IP 3	IP 4	IP 5	IP 6	IP 7	IP 8
	Meaning for the protection of equipment against ingress of solid foreign objects	Meaning for the protection of persons against access to hazardous parts with	Non-protected	Protected against vertically falling water drops.	Protected against vertically falling water drops when device is tilted up to 15°	Water sprayed at an angle up to 60° on either side of the vertical shall have no harmful effects	Water splashed from any direction shall have no harmful effects	Water projected in jets from any direction shall have no harmful effects	Water projected in powerful jets from any direction shall have no harmful effects	Protected against temporary immersion	Protected against continuous immersion
IP 0	non-protected	non-protected	IP 00								
IP 1	Protected against solid foreign objects larger in diameter than 50mm (1.97 in.)	Protected against access to hazardous parts with the back of the hand	IP 10	IP 11	IP 12						
IP 2	Protected against solid foreign objects larger in diameter than 12.5mm (.49 in.)	Protected against access to hazardous parts with a finger	IP 20	IP 21	IP 22	IP 23					
IP 3	Protected against solid foreign objects larger in diameter than 2.5mm (.10 in.)	Protected against access to hazardous parts with a tool larger in diameter than 2.5 mm (.10 in.)	IP 30	IP 31	IP 32	IP 33	IP 34				
IP 4	Protected against solid foreign objects larger in diameter than 1.0mm (.04 in.)	Protected against access to hazardous parts with a wire larger in diameter than 1.0mm (.04 in.)	IP 40	IP 41	IP 42	IP 43	IP 44				
IP 5	Ingress of dust is not totally prevented, but dust shall not penetrate in a quantity to interfere with satisfactory operation of the apparatus or to impair safety	Protected against access to hazardous parts with a wire larger in diameter than 1.0mm (.04 in.)					IP 54	IP 55			
IP 6	No ingress of dust	Protected against access to hazardous parts with a wire larger in diameter than 1.0mm (.04 in.)							IP 66	IP 67	IP 68

Note: Protection Rating for each product is shown on ordering page.

# CHART II

## NEMA / IP Cross Reference

The chart below provides a cross-reference from NEMA to International Protection (IP) Ratings. This cross-reference is an approximation based on the most current information available. It is not sanctioned by NEMA, IEC, or any other regulatory body. This chart should be used only as a guideline.

IEC 529 Protection Ratings	NEMA Ratings									
	1	2	3	3R	4	4X	5	6	12	13
IP00	↓									
IP10		↓								
IP11										
IP 20										
IP 21										
IP 22										
IP 23										
IP 30										
IP 31										
IP 32				↓						
IP 33										
IP 40										
IP 41										
IP 42										
IP 43										
IP 50										
IP 51							↓			
IP 52										
IP 53										
IP 54									↓	
IP 55										↓
IP 56										
IP 60										
IP 61										
IP 62										
IP 63			↓							
IP 64										
IP 65										
IP 66					↓	↓				
IP 67								↓		
IP 68										

## CHART III CHEMICAL RESISTANCE

		BODY MATERIAL					SEALING INSERT MATERIAL					SEAL RING MATERIAL				
		Polyamide (PA)	PVDF Polyvinylidene (PO)	Polystyrene (PS)	Brass, Nickel Plated (BN)	Stainless Steel (SS)	Neoprene (NE)	Santoprene (ST)	PVC Polyvinylchloride (PV)	Rubber (RU)	Silicone (SI)	TPE Polyolefin (TP)	Polyethylene (PE)	Centellen (CE)	Silicone (SI)	Perbunan (PR)
*	●	●	○	●	○	○	*	○	○	○	▶	●	○	▶	#1 Fuel Oil	
●	●	●	●	●	○	○	○	○	○	○	▶	●	○	▶	#2 Fuel Oil	
○	▶	○	●	●	▶	●	*	▶	○	*	*	○	○	Acetone		
●	●	●	●	●	*	○	●	●	●	*	*	●	*	Ammonia		
*	*	▶	●	●	○	○	▶	○	○	▶	●	●	●	ASTM #1 Oil		
*	*	▶	●	●	○	○	▶	○	▶	○	▶	●	●	ASTM #3 Oil		
●	●	○	●	●	○	○	○	○	○	*	●	○	*	Benzene		
*	*	*	●	●	○	○	*	●	●	○	●	*	*	Brake Fluid		
●	●	●	●	●	*	○	▶	*	●	●	○	*	*	Caustic Soda 50%		
*	●	○	●	●	▶	*	○	○	*	●	*	▶	*	Chlorine Water 10ppm		
*	*	*	●	●	○	○	*	○	▶	*	*	▶	▶	Cutting Fluids		
●	●	▶	●	●	○	○	○	○	○	*	*	○	*	Gasoline		
*	*	*	●	●	○	○	*	○	○	▶	●	●	●	Hydraulic Oil		
○	*	●	●	●	○	○	*	○	○	●	●	●	*	Isopropyl Alcohol		
▶	*	*	●	●	○	○	*	○	○	*	*	*	*	Lacquer Thinner		
*	▶	●	*	*	*	*	▶	*	*	*	*	*	*	Lactic Acid		
○	●	●	●	●	○	○	▶	●	●	●	▶	●	*	Methyl Alcohol		
●	●	*	●	●	*	*	*	○	*	○	▶	●	*	Mineral Oil		
*	*	*	●	●	○	○	*	○	○	*	▶	*	○	Mineral Spirits		
○	●	▶	○	▶	○	▶	▶	▶	*	○	○	○	○	Nitric Acid 25%		
●	●	●	○	▶	▶	*	▶	*	*	○	*	*	*	Muriatic Acid 10%		
▶	●	●	○	▶	▶	●	●	●	▶	*	○	●	*	Phosphoric Acid 25%		
●	●	*	○	▶	▶	○	○	▶	*	○	○	●	*	Sulfuric Acid 25%		
●	●	○	●	●	○	○	○	○	*	*	*	○	*	Toluene		
*	*	*	●	●	○	○	*	○	▶	○	○	▶	*	Turpentine		
*	●	●	●	●	*	●	●	○	○	▶	●	○	●	Vegetable Oils & Fats		

Use this Table as a guide to determine whether the materials intended to be used are suitable for your application.

Please note that the Chemical Resistance can only be used as a guideline. Material properties can change with temperature, humidity, etc.

Contact Altech if you have any questions or need help in selecting materials.

### Key

- = Good Resistance
- ▶ = Limited Resistance
- = Not Recommended
- \* = Consult Altech

Selection Criteria	STANDARD		HIGH PERFORMANCE				ECONOMY	
	PA	BN	PA	PO	BN	SS	PS	BN
Liquid Tight	Yes	Yes	Yes	Yes	Yes	Yes	Yes	Yes
Strain Relief	●	●	●	●	●	●	▶	▶
Corrosion Resistance	●	●	●	●	●	●	●	●
Chemical Resistance	▶	●	▶	▶	●	●	▶	●
Quick Installation	Yes	Yes	Yes	Yes	Yes	Yes	Yes	Yes
Selection of Colors	Yes	-	Yes	Yes	-	-	No	-
Pressure Dome/Nut	Dome	Dome	Dome	Dome	Dome	Dome	Nut	Nut
Fully Insulated	Yes	▶	Yes	Yes	▶	▶	Yes	▶
Rubber Sealing Ring	-	-	-	-	-	-	Yes	Yes
Sealing Sleeve	Yes <sup>3</sup>	Yes <sup>3</sup>	-	-	-	-	-	-
Tubular Sealing Insert	-	-	Yes	Yes	Yes	Yes	-	-
Preinstalled Seal Ring	PG29 - PG48	Yes	No	No	Yes	Yes	No	No
Integral Sealing Ridges	PG7 - PG21	No	No	No	No	No	No	No
Protection- IEC <sup>1</sup>	IP68	IP68	IP68	IP68	IP68	IP68	IP55	IP55
Protection- NEMA <sup>1</sup>	1, 2, 3, 3R, 4, 4X, 5, 6, 12, 13	1, 2, 3, 3R, 4, 4X, 5, 6, 12, 13	1, 2, 3, 3R, 4, 4X, 5, 6, 12, 13	1, 2, 3, 3R, 4, 4X, 5, 6, 12, 13	1, 2, 3, 3R, 4, 4X, 5, 6, 12, 13	1, 2, 3, 3R, 4, 4X, 5, 6, 12, 13	1, 2, 5, 12, 13	1, 2, 5, 12, 13
Max. Temperature <sup>2</sup>	100°C (212°F)	100°C (212°F)	100°C (212°F)	150°C (302°F) <sup>2</sup>	200°C (392°F) <sup>2</sup>	200°C (392°F) <sup>2</sup>	65°C (149°F)	80°C (176°F)
Min. Temperature <sup>2</sup>	-20°C (-4°F)	-40°C (-40°F)	-20°C (-4°F)	-40°C (-40°F) <sup>2</sup>	-40°C (-40°F) <sup>2</sup>	-60°C (-65°F) <sup>2</sup>	-20°C (-4°F)	-20°C (-4°F)
Cable Diameter mm	2.0 - 44.0	2.0 - 44.0	5.0 - 44.0	4.0 - 44.0	4.0 - 44.0	4.0 - 40.0	5.0 - 47.0	5.0 - 47.0
Cable Diameter (in.)	(.08 - 1.73)	(.08 - 1.73)	(.20 - 1.73)	(.16 - 1.73)	(.16 - 1.73)	(.16 - 1.57)	(.20 - 1.85)	(.20 - 1.85)

## CHART IV SELECTION CRITERIA

### Key

- = Good
- ▶ = Limited

### Material Key

- PS = Polystyrene
- PA = Polyamide
- PO = PVDF Polyvinylidene-fluoride
- BN = Brass, Nickel Plated
- SS = Stainless Steel

<sup>1</sup>Refer to page 6 for explanation. Refer to appropriate ordering pages for exceptions.

<sup>2</sup>Temperature may be limited by seal or body materials. Refer to each ordering page.

<sup>3</sup>Except for Multi-Conductor and Flat Cable Liquid Tight Strain Reliefs, which use a Sealing Ring.



## CHART V

### POSSIBLE COMBINATIONS OF BODY AND SEALING MATERIALS BY FUNCTION

To simplify selection, possible material combinations are shown. Please refer to the pages indicated for technical and ordering information.

#### 1. Straight-Through

Sealing plus standard strain relief.



Sealing Material	STANDARD			HIGH PERFORMANCE			ECONOMY	
	Body Material	Polyamide (PA)	Brass, Nickel Plated (BN)	Polyamide (PA)	PVDF Polyvinylidene (PO)	Brass, Nickel Plated (BN)	Stainless Steel (SS)	Polystyrene (PS)
Neoprene (NE)	16	17						
PVC Polyvinylchloride (PV)			28	30	32	34		
Santoprene (ST)			29	31	33	35		
TPE Polyolefin (TP)				31	33	35		
Silicone (SI)				31	33	35		
Rubber (RU)							51	51

#### 2. Increased Strain Relief

Sealing plus increased strain relief.



Sealing Material	STANDARD			HIGH PERFORMANCE			ECONOMY	
	Body Material	Polyamide (PA)	Brass, Nickel Plated (BN)	Polyamide (PA)	PVDF Polyvinylidene (PO)	Brass, Nickel Plated (BN)	Stainless Steel (SS)	Polystyrene (PS)
Neoprene (NE)		19						
PVC Polyvinylchloride (PV)			36	37	37			
Santoprene (ST)								
TPE Polyolefin (TP)								
Silicone (SI)								
Rubber (RU)	19							

#### 3. Bend

Sealing plus bend protection and standard strain relief.



Sealing Material	STANDARD			HIGH PERFORMANCE			ECONOMY	
	Body Material	Polyamide (PA)	Brass, Nickel Plated (BN)	Polyamide (PA)	PVDF Polyvinylidene (PO)	Brass, Nickel Plated (BN)	Stainless Steel (SS)	Polystyrene (PS)
Neoprene (NE)	18							
PVC Polyvinylchloride (PV)			38	39	39			
Santoprene (ST)								
TPE Polyolefin (TP)								
Silicone (SI)								
Rubber (RU)								

## 4. Pull / Bend

Sealing plus bend protection and increased strain relief.



Sealing Material	STANDARD			HIGH PERFORMANCE			ECONOMY	
	Body Material	Polyamide (PA)	Brass, Nickel Plated (BN)	Polyamide (PA)	PVDF Polyvinylidene (PO)	Brass, Nickel Plated (BN)	Stainless Steel (SS)	Polystyrene (PS)
Neoprene (NE)		19						
PVC Polyvinylchloride (PV)			40		41			
Santoprene (ST)								
TPE Polyolefin (TP)								
Silicone (SI)								
Rubber (RU)	19							

## 5. Multi-Conductor

Sealing plus strain relief for multiple conductors, cables or cords of identical or different diameters.



Sealing Material	STANDARD			HIGH PERFORMANCE			ECONOMY	
	Body Material	Polyamide (PA)	Brass, Nickel Plated (BN)	Polyamide (PA)	PVDF Polyvinylidene (PO)	Brass, Nickel Plated (BN)	Stainless Steel (SS)	Polystyrene (PS)
Neoprene (NE)								
PVC Polyvinylchloride (PV)	20		42 - 45 <sup>1</sup>		42 - 45 <sup>1</sup>			
Santoprene (ST)								
TPE Polyolefin (TP)								
Silicone (SI)								
Rubber (RU)								

1. Multi-Conductor Bodies page 42; Multi-Conductor Inserts pages 43 - 45.

## 6. Flat Cable

Sealing plus strain relief for flat cables.



Sealing Material	STANDARD			HIGH PERFORMANCE			ECONOMY	
	Body Material	Polyamide (PA)	Brass, Nickel Plated (BN)	Polyamide (PA)	PVDF Polyvinylidene (PO)	Brass, Nickel Plated (BN)	Stainless Steel (SS)	Polystyrene (PS)
Neoprene (NE)	21							
PVC Polyvinylchloride (PV)			48 - 49 <sup>2</sup>		49			
Santoprene (ST)								
TPE Polyolefin (TP)								
Silicone (SI)								
Rubber (RU)								

2. Flat Cable Bodies page 48; Flat Cable Inserts page 49.

## 7. EMI / RFI

Sealing and strain relief plus shielding against electromagnetic and radio frequency interference.



Sealing Material	STANDARD			HIGH PERFORMANCE			ECONOMY	
	Body Material	Polyamide (PA)	Brass, Nickel Plated (BN)	Polyamide (PA)	PVDF Polyvinylidene (PO)	Brass, Nickel Plated (BN)	Stainless Steel (SS)	Polystyrene (PS)
Neoprene (NE)								
PVC Polyvinylchloride (PV)								
Santoprene (ST)					47			
TPE Polyolefin (TP)								
Silicone (SI)								
Rubber (RU)								

# How To Order Liquid Tight Strain Reliefs From Altech

We have provided this sample page to help you order Liquid Tight Strain Reliefs from Altech. This page provides you with information on how to read the ordering pages inclusive of a legend and abbreviations used, which are consistent throughout the catalog.

**STANDARD** \_\_\_\_\_ 1

**STRAIGHT-THROUGH** \_\_\_\_\_ 2

**Polyamide (PA)** \_\_\_\_\_ 3

- IP68 (NEMA 1, 2, 3, 3R, 4, 4X, 5, 6, 12, 13).
- PG, NPT standard. Metric available.
- Integral Sealing Ridges (Only PG7 to PG21 and NPT3/8 to NPT3/4). Order Seal Rings separately if required.
- Preinstalled Perbunan (PR) Seal Rings (Only PG29 to PG48).
- Standard Color: Light Gray and Black, Dark Gray available.



4  
5  
6  
7

**Polyamide (PA)  
with Neoprene (NE) Sealing Sleeve**

Temperature Ranges	
Body	Sealing Sleeve
Polyamide (PA)	Neoprene (NE)
-20 to 100°C (-4 to 176°F)	-20 to 80°C (-4 to 176°F)

Type	Cat. No. Lt. Gray	Std. Black	Pk.	Cable Dia. mm	(in.)	Mtg. Hole Dia. <sup>1</sup> mm	(in.)	Nearest Drill Size
PG7 - S S PA- [ ] [ ] 05	80.000	80.030	100	2.0- 5.0	(.08- .20)	13.0	(.51)	33/64
8 9 10 11 12 13 14	15	16	17	18	19	20	21	22

## Legend

- |  |  |
|--|--|
| 1- Product Group                         | 14-Maximum usable Cable Diameter in millimeters rounded down to the nearest whole number |
| 2- Function                              | 15 and 16 - Catalog Numbers  |
| 3- Body Material                         | 17-Standard Pack   |
| 4- Brief Description and Technical Info. | 18-Cable Diameter Range in millimeters   |
| 5- Photograph of Product                 | 19-Cable Diameter Range in inches  |
| 6- Photo Caption                         | 20-Mounting Hole Diameter in millimeters   |
| 7- Chart Headers                         | 21-Mounting Hole Diameter in inches  |
| 8- Thread Type and Size                  | 22-Nearest suitable Drill Size for Mounting Hole   |
| 9- Product Group                         |  |
| 10-Function                              |  |
| 11-Body Material                         |  |
| 12-Body Color                            |  |
| 13-Insert Material                       |  |

## Standard Abbreviations

### Product Groups

- S** - Standard
- P** - High Performance
- E** - Economy

### Functions

- S** - Straight Through
- I** - Increased Strain Relief
- B** - Bend
- P** - Pull / Bend
- M** - Multi-Conductor
- F** - Flat Cable
- E** - EMI / RFI

### Body Materials

- BN** - Brass, Nickel Plated
- PA** - Polyamide
- PO** - PVDF Polyvinylidene
- PS** - Polystyrene
- SS** - Stainless Steel

### Body Colors

- BD** - Dark Blue
- BE** - Beige
- BK** - Black
- BL** - Light Blue
- BM** - Medium Blue
- BR** - Brown
- DG** - Dark Gray
- GR** - Green
- IV** - Ivory
- LG** - Light Gray
- MG** - Medium Gray
- OL** - Olive
- OP** - Opaque
- OR** - Orange
- RD** - Red
- TN** - Tan
- TU** - Turquoise
- WT** - White

### Insert Materials

- NE** - Neoprene
- PV** - PVC Polyvinylchloride
- RU** - Rubber
- SI** - Silicone
- ST** - Santoprene
- TP** - TPE Polyolefin



# Product Bulletin

## Introducing Pulsotronic Proximity Sensors. . . The Newest Addition to Altech Corp.'s Line of Control and Automation Products!

Altech / Pulsotronic now offer a comprehensive line of Proximity Sensors to satisfy today's diverse sensor applications. Our sensors are used for a wide range of functions in industrial plants and machinery.

Typical applications of our sensors include automatic machinery, conveyor systems, machine tools, packaging machines, production lines, robotic systems, etc.

Altech / Pulsotronic Proximity Sensors are available in DC (PNP and NPN) and AC, n.o./n.c. and flush and non-flush configurations. They are available in Tubular, Limit, Block and Ring models.



*Proximity Sensor in a conveyer application.*



### Pulsotronic Proximity Sensors:

- π 25 years of proven quality and reliability
- π Pulsotronic manufacturing is ISO 9001 Certified
- π Selection of Quick Disconnects
- π Choose from Tubular, Limit, Block, and Ring Sensors
- π Immediate delivery of most models
- π New line of rotatable, 25-position Limit Style Sensors now available
- π Short circuit, overload, and reverse polarity protection

### Specifications:

- π Digital output standard. Linear output available
- π Meet or exceed IP67 (NEMA 1, 2, 3, 3R, 4, 4X, 5, 6, 12, 13) protection specifications
- π 10 - 30 VDC and 20 - 250 VAC, 120 - 500 mA current
- π 0.5mm to 1600mm (0.01 to 63 in.) sensing range

---

***To find out more about our new,  
extensive line of Proximity  
Sensors,***

***contact us at:***

**Altech Corp.®**

35 Royal Road • Flemington NJ 08822-6000  
Phone (908) 806-9400 • Fax (908) 806-9490



---

Offering an excellent price / performance ratio, the Standard Liquid Tight Strain Reliefs are suitable for a wide range of applications. They can be used with cables, cords, etc. in a wide range of diameters.

Select the most suitable Cord Grip for your application from a variety of Functions, Body and Sealing Insert material combinations.

**Body Materials**

- Polyamide (PA)
- Brass, Nickel Plated (BN)

**Sealing Sleeve Material**

- Neoprene (NE)

**Sealing Insert Material**

- Multi-Conductor: PVC  
Polyvinylchloride (PV)
- Flat Cable: Neoprene (NE)

**Functions**

- Straight-Through
- Bend
- Pull / Bend
- Multi-Conductor
- Flat Cable

**Protection Rating**

Up to IP68  
(NEMA 1, 2, 3, 3R, 4, 4X, 5, 6, 12, 13)

---

# STANDARD

Standard Cord Grips are supplied complete and ready to install. The illustration below shows the various components of the Nonmetallic and the Metal Straight-Through Cord Grips. Basic functions for each component are described below.

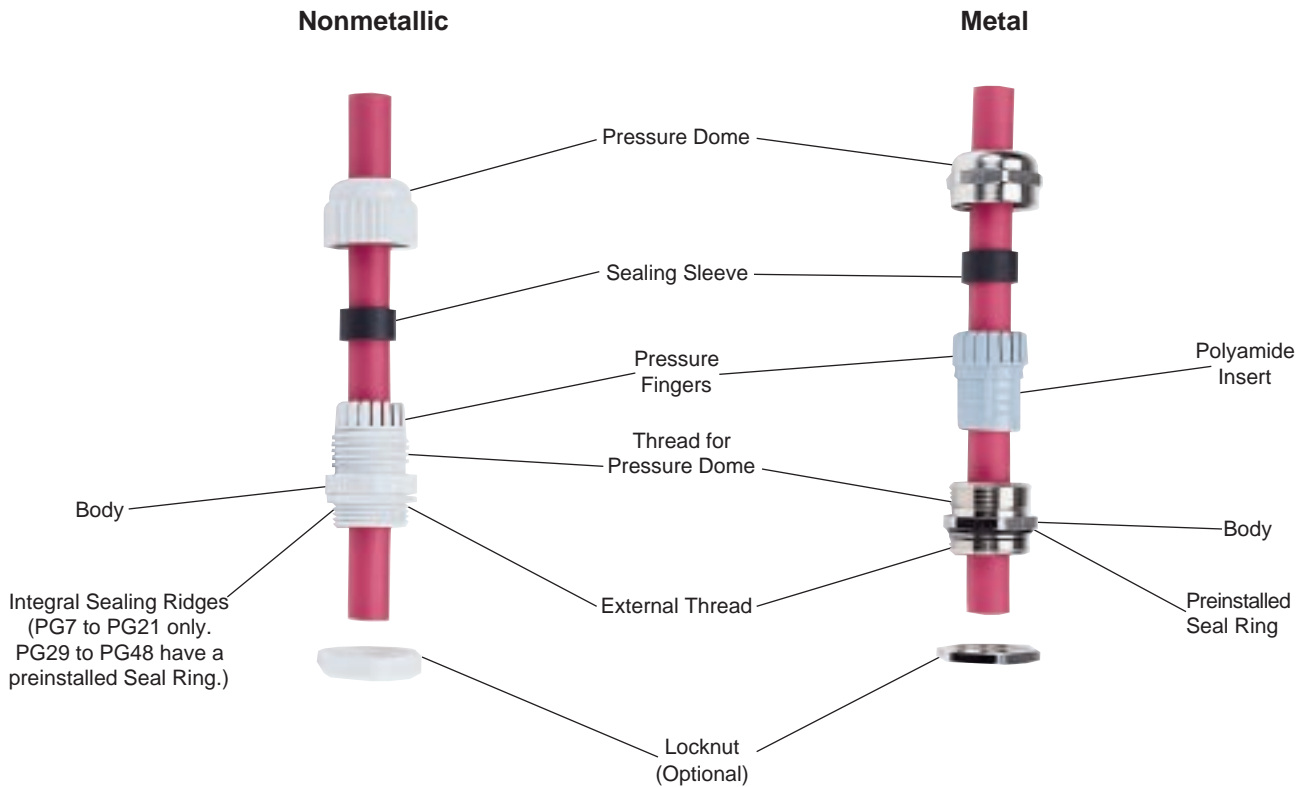

## Pressure Dome

The conical interior of the Pressure Dome transfers pressure to the Pressure Fingers when the Dome is tightened.

“Secur-Grip” grooves, molded into the outer surface of the Dome, provide a secure gripping surface (Polyamide (PA) types).

## Pressure Fingers

Pressure Fingers are an integral part of the Cord Grip Body and Polyamide (PA) Insert (Brass, Nickel Plated (BN)) and are arranged concentrically. When the Pressure Dome is tightened, they push the Sealing Sleeve against the cable or cord and help provide sealing and strain relief functions.

## Sealing Sleeve

The Sealing Sleeve is contained by the Pressure Fingers and a circular

groove inside the Body and Polyamide (PA) Insert. It provides strain relief and prevents rotation of the cable when the Pressure Dome is tightened.

## Polyamide (PA) Insert

The Brass, Nickel Plated (BN) Cord Grip Body contains a Polyamide (PA) Insert with Pressure Fingers. Molded-in splines fit into grooves at the lower end of the Brass, Nickel Plated (BN) Body and prevent rotation of the insert and cable during installation.

## External Seal

The External Seal provides a hermetic seal between the Cord Grip and the enclosure wall. Integral Sealing Ridges are standard on Polyamide (PA) Cord Grips sizes PG7 to PG21, and NPT 3/8, 1/2, 3/4 sizes. Sizes PG29 through PG48 have factory

installed Seal Rings. If required, Seal

Rings can also be used for sizes PG7 through PG21 and NPT 3/8, 1/2 and 3/4. Please refer to page 52 for ordering information.

All Standard Series Brass, Nickel Plated (BN) Cord Grips are delivered with preinstalled Perbunan (PR) Seal Rings.

## External Thread

Most Standard Series Cord Grips are offered with external PG or NPT threads. For metric and extended length threads, please contact Altech.

## Locknuts

Use Locknuts for installation into nonthreaded holes. Order Locknuts separately. Please refer to each ordering page or to page 54 for technical and ordering information.

## Straight-Through, pages 16 and 17

Provide a liquid-tight seal and reliable strain relief for most applications.



### Sealing Function

The sealing function for the Polyamide (PA) and the Brass, Nickel Plated (BN) Cord Grips is identical.

When tightening the Pressure Dome, the conical interior surface applies pressure to the tips of the concentrically arranged Pressure Fingers, forcing them to move towards the center. This movement is transferred to the Sealing Sleeve, causing it to contract and provide a seal to the installed cable.

### Installation

Please refer to page 5 to install Cord Grips.

## Bend Protection, page 18

Bend Protection Cord Grips provide standard Pull-Out (Strain Relief) plus Bend protection. The increased bending radius is achieved by a "Pigtail" extension, which reduces punctual stress and the possibility of cable/cord damage.



### Sealing Function

Uses the same sealing function as Straight-Through Cord Grips.

### Installation

Please refer to page 5 to install Cord Grips.

## Pull / Bend Protection, page 19

Trumpet-shaped Pull / Bend Cord Grips provide increased Strain Relief and Bend protection by increasing the bending radius of the cable/cord, reducing the possibility of cable/cord damage.



Polyamide (PA)

Brass, Nickel Plated (BN)

### Sealing Function

When tightening the trumpet-shaped extension, the Neoprene (NE) (Brass, Nickel Plated (BN)) or Rubber (RU) Sealing Ring (Polyamide (PA)) is compressed, providing a seal to the installed cable.

### Installation

Please refer to page 5 to install Cord Grips.

1. Install Cord Grip.
2. Loosen stainless steel screws and open clamp.
3. Insert cable/cord
4. Tighten trumpet-shaped Pressure Nut.
5. Tighten screws until cable/cord is securely installed.

	Function					
	Straight -Through		Bend	Pull / Bend		
Body Material	Polyamide (PA)		Brass, Nickel Plated (BN)	Polyamide (PA)		
Standard Color	Lt. Gray, Black	—	Lt. Gray, Black	Lt. Gray	—	
Sealing Ring / Sleeve	NE	NE	NE	RU	NE	
Seal Ring Preinstalled	Yes†	Yes	No	No	No	
Sizes	PG	PG7 - PG48	PG7 - PG21	PG9 - PG29	PG9 - PG29	
	NPT	NPT3/8-3/4	NPT3/8-3/4	—	—	
Cable	mm	2.0 - 44.0	2.0 - 44.0	3.5 - 18.0	5.5 - 25.0	
Diameter (in.)		(.08 - 1.73)	(.08 - 1.73)	(.14 - .71)	(.22 - .98)	
				(.24 - 1.18)		

**Key**  
 NE = Neoprene  
 RU = Rubber  
 † = PG29 - PG48 only



## Multi-Conductor page 20

For limited space applications whenever two or more cables, cords or conductors must be installed through a single Cord Grip.

Insert Sealing Inserts with premolded holes for cables, cords or conductors of identical diameters.

Use Sealing Plugs to seal unused holes, ensuring proper strain relief and IP54 (NEMA 1, 2, 5, 12, 13) protection for installed cables. Please refer to page 52.

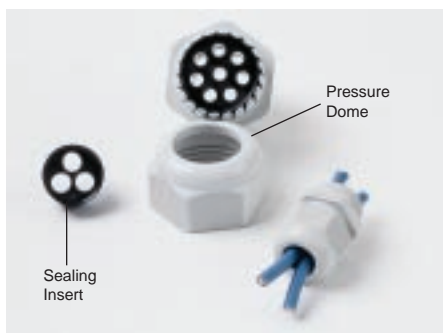

### Sealing Function

When tightening the Pressure Dome, the conical interior surface applies pressure onto the tips of the concentrically arranged Pressure Fingers, forcing them to move towards the center. This movement is transferred to the Sealing Insert, causing it to contract and seal the cables/cords or conductors.

### Installation

Please refer to page 5 to install Cord Grips. Insert Cables after installing Cord Grips. Plug unused holes to obtain rated protection and strain relief after cables have been installed, but before tightening Pressure Dome.

## Flat Cable page 21

Flat Cable for Cord Grips are typically used with festooning cables. The openings in the sealing insert have rounded corners to match the shape of the cable, providing a liquid tight seal and reliable strain relief.



### Sealing Function

When the Pressure Nut is tightened, pressure is applied to the Galvanized Steel Washers. This pressure is transferred to the Sealing Insert, causing it to contract and seal the cable.

### Installation

Please refer to page 5 to install Cord Grips.

1. Remove Pressure Nut, Washers and Sealing Insert.
2. Slide Pressure Nut, Washer 1, Sealing Insert and Washer 2 onto the Flat Cable.
3. Install the cable with the installed parts into the Cord Grip Body.
4. Tighten Pressure Nut.

	Function	
	Multi-Conductor	Flat Cable
Body Material	Polyamide (PA)	Polyamide (PA), Glass Fiber
Standard Color	Lt. Gray, Black	Lt. Gray
Sealing Ring / Sleeve	PV	NE
Seal Ring Preinstalled	Yes††	No
Sizes	PG11 - PG29	PG16 - PG48
	PG NPT	—
Cable mm	4.0 - 9.0	5x15-14x44
Diameter (in.)	(.16 - .35)	.20x.59-.63x1.73

**Key**  
 PV = PVC Polyvinylchloride  
 NE = Neoprene  
 †† = PG29 only

## Material and Temperature Ranges By Function

### Straight-Through Polyamide (PA)

Body: Polyamide (PA)  
 -20 to 100°C (-4 to 212°F)  
 Sealing Sleeve: Neoprene (NE)  
 -40 to 100°C (-40 to 212°F)

### Brass, Nickel Plated (BN)

Body: Brass, Nickel Plated (BN)  
 -40 to 300°C (-40 to 572°F)  
 Sealing Sleeve: Neoprene (NE)  
 -40 to 100°C (-40 to 212°F)  
 Seal Ring: Perbunan (PR)  
 -20 to 120°C (-4 to 248°F)

### Multi-Conductor

Body: Polyamide (PA)  
 -20 to 100°C (-4 to 212°F)  
 Sealing Insert: PVC Polyvinylchloride (PV)  
 -20 to 80°C (-4 to 176°F)

### Flat Cable

Body: Polyamide (PA) Glass-Fiber Reinforced  
 -20 to 100°C (-4 to 212°F)  
 Sealing Insert: Neoprene (NE)  
 -40 to 100°C (-40 to 212°F)

### Bend

Body: Polyamide (PA)  
 -20 to 100°C (-4 to 212°F)  
 Sealing Sleeve: Neoprene (NE)  
 -40 to 100°C (-40 to 212°F)

### Pull / Bend

Polyamide (PA)  
 Body: Polyamide (PA) Glass-Fiber Reinforced  
 -20 to 100°C (-4 to 212°F)  
 Sealing Ring: Rubber (RU)  
 -20 to 60°C (-4 to 140°F)

### Brass, Nickel Plated (BN)

Body: Brass, Nickel Plated (BN)  
 -40 to 300°C (-40 to 572°F)  
 Sealing Sleeve: Neoprene (NE)  
 -40 to 100°C (-40 to 212°F)  
 Seal Ring: Perbunan (PR)  
 -20 to 120°C (-4 to 248°F)

## Accessories

Ordering information for Accessories is shown on each ordering page. Please refer to pages 52 through 54 for detailed information.

# STANDARD STRAIGHT-THROUGH

## Polyamide (PA)

- IP68 (NEMA 1, 2, 3, 3R, 4, 4X, 5, 6, 12, 13).
- PG, NPT standard. Metric available.
- Integral Sealing Ridges (Only PG7 to PG21 and NPT3/8 to NPT3/4). Order Seal Rings separately if required.
- Preinstalled Perbunan (PR) Seal Rings (Only PG29 to PG48).
- Standard Color: Light Gray and Black, Dark Gray available.



Temperature Ranges	
Body	Sealing Sleeve
Polyamide (PA)	Neoprene (NE)
-20 to 100°C (-4 to 212°F)	-40 to 100°C (-40 to 212°F)

## Polyamide (PA) with Neoprene (NE) Sealing Sleeve

Liquid Tight Strain Reliefs (Cord Grips)					Seal Rings <sup>3</sup> Polyethylene (PE)			Locknuts <sup>2</sup> Polyamide (PA)					
Type	Cat. No. Lt. Gray	Cat. No. Black	Std. Pk.	Cable Dia.			Nearest Drill Size	Cat. No. Opaque	Std. Pk.	Cat. No.		Std. Pk.	
				mm	(in.)	Mtg. Hole Dia. <sup>1</sup> mm (in.)				Lt. Gray	Black		
PG7-SSPA - <input type="checkbox"/>	NE 05	<b>80.000</b>	<b>80.030</b>	100	2.0- 5.0	(.08- .20)	13.0 (.51)	33/64	<b>86.600</b>	100	<b>86.000</b>	<b>86.021</b>	100
PG7-SSPA - <input type="checkbox"/>	NE 06	<b>80.001</b>	<b>80.031</b>	100	3.0- 6.5	(.12- .26)	13.0 (.51)	33/64	<b>86.600</b>	100	<b>86.000</b>	<b>86.021</b>	100
PG9-SSPA - <input type="checkbox"/>	NE 06	<b>80.002</b>	<b>80.032</b>	100	2.0- 6.0	(.08- .24)	15.5 (.61)	39/64	<b>86.601</b>	100	<b>86.001</b>	<b>86.022</b>	100
PG9-SSPA - <input type="checkbox"/>	NE 08	<b>80.003</b>	<b>80.033</b>	100	4.0- 8.0	(.16- .31)	15.5 (.61)	39/64	<b>86.601</b>	100	<b>86.001</b>	<b>86.022</b>	100
PG11-SSPA - <input type="checkbox"/>	NE 07	<b>80.004</b>	<b>80.034</b>	100	3.0- 7.0	(.12- .28)	19.0 (.75)	3/4	<b>86.602</b>	100	<b>86.002</b>	<b>86.023</b>	100
PG11-SSPA - <input type="checkbox"/>	NE 10	<b>80.005</b>	<b>80.035</b>	100	5.0-10.0	(.20- .39)	19.0 (.75)	3/4	<b>86.602</b>	100	<b>86.002</b>	<b>86.023</b>	100
PG13.5-SSPA - <input type="checkbox"/>	NE 09	<b>80.006</b>	<b>80.036</b>	100	5.0- 9.0	(.20- .35)	21.0 (.83)	53/64	<b>86.603</b>	100	<b>86.003</b>	<b>86.024</b>	100
PG13.5-SSPA - <input type="checkbox"/>	NE 12	<b>80.007</b>	<b>80.037</b>	100	6.0-12.0	(.24- .47)	21.0 (.83)	53/64	<b>86.603</b>	100	<b>86.003</b>	<b>86.024</b>	100
PG16-SSPA - <input type="checkbox"/>	NE 12	<b>80.008</b>	<b>80.038</b>	50	7.0-12.0	(.28- .47)	23.0 (.91)	29/32	<b>86.604</b>	50	<b>86.004</b>	<b>86.025</b>	50
PG16-SSPA - <input type="checkbox"/>	NE 14	<b>80.009</b>	<b>80.039</b>	50	10.0-14.0	(.39- .55)	23.0 (.91)	29/32	<b>86.604</b>	50	<b>86.004</b>	<b>86.025</b>	50
PG21-SSPA - <input type="checkbox"/>	NE 16	<b>80.010</b>	<b>80.040</b>	50	9.0-16.0	(.35- .63)	29.0 (1.14)	1-9/64	<b>86.605</b>	50	<b>86.005</b>	<b>86.026</b>	50
PG21-SSPA - <input type="checkbox"/>	NE 18	<b>80.011</b>	<b>80.041</b>	50	13.0-18.0	(.51- .71)	29.0 (1.14)	1-9/64	<b>86.605</b>	50	<b>86.005</b>	<b>86.026</b>	50
PG29-SSPA - <input type="checkbox"/>	NE 20	<b>80.012</b>	<b>80.042</b>	25	12.0-20.0	(.47- .79)	37.5 (1.48)	1-31/64	Preinstalled		<b>86.006</b>	<b>86.027</b>	25
PG29-SSPA - <input type="checkbox"/>	NE 25	<b>80.013</b>	<b>80.043</b>	25	18.0-25.0	(.71- .98)	37.5 (1.48)	1-31/64		<b>86.006</b>	<b>86.027</b>	25	
PG36-SSPA - <input type="checkbox"/>	NE 26	<b>80.014</b>	<b>80.044</b>	10	20.0-26.0	(.79-1.02)	47.5 (1.87)	1-7/8		<b>86.007</b>	<b>86.028</b>	10	
PG36-SSPA - <input type="checkbox"/>	NE 32	<b>80.015</b>	<b>80.045</b>	10	22.0-32.0	(.87-1.26)	47.5 (1.87)	1-7/8		<b>86.007</b>	<b>86.028</b>	10	
PG42-SSPA - <input type="checkbox"/>	NE 38	<b>80.017</b>	<b>80.047</b>	5	30.0-38.0	(1.18-1.50)	54.5 (2.15)	2-5/32		<b>86.008</b>	<b>86.029</b>	5	
PG48-SSPA - <input type="checkbox"/>	NE 44	<b>80.019</b>	<b>80.049</b>	5	34.0-44.0	(1.34-1.73)	60.0 (2.36)	2-3/8		<b>86.009</b>	<b>86.030</b>	5	
NPT3/8-SSPA - <input type="checkbox"/>	NE 07	<b>80.020</b>	<b>80.050</b>	50	3.0- 7.0	(.12- .28)	17.5 (.69)	11/16	<b>86.602</b>	50	<b>86.061</b>	<b>86.081</b>	50
NPT3/8-SSPA - <input type="checkbox"/>	NE 10	<b>80.021</b>	<b>80.051</b>	50	5.0-10.0	(.20- .39)	17.5 (.69)	11/16	<b>86.602</b>	50	<b>86.061</b>	<b>86.081</b>	50
NPT1/2-SSPA - <input type="checkbox"/>	NE 12	<b>80.022</b>	<b>80.052</b>	50	7.0-12.0	(.28- .47)	21.5 (.85)	27/32	<b>86.603</b>	50	<b>86.062</b>	<b>86.082</b>	50
NPT1/2-SSPA - <input type="checkbox"/>	NE 14	<b>80.023</b>	<b>80.053</b>	50	10.0-14.0	(.39- .55)	21.5 (.85)	27/32	<b>86.603</b>	50	<b>86.062</b>	<b>86.082</b>	50
NPT3/4-SSPA - <input type="checkbox"/>	NE 16	<b>80.024</b>	<b>80.054</b>	25	9.0-16.0	(.35- .63)	27.0 (1.06)	1-1/16	<b>86.605</b>	25	<b>86.063</b>	<b>86.083</b>	25
NPT3/4-SSPA - <input type="checkbox"/>	NE 18	<b>80.025</b>	<b>80.055</b>	25	13.0-18.0	(.51- .71)	27.0 (1.06)	1-1/16	<b>86.605</b>	25	<b>86.063</b>	<b>86.083</b>	25

Body Color, Example: Light Gray  or Black

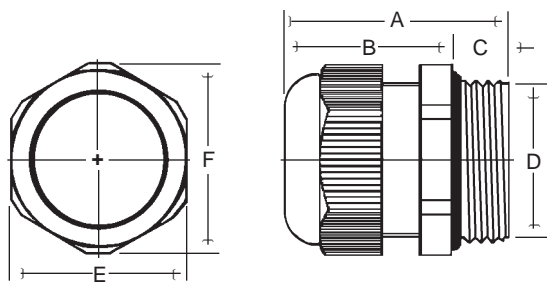

### Dimensions mm (in.)

Size	A	B	C	D	E	F
PG7	30.0 (.118)	22.0 (.87)	8.0 (.31)	12.5 (.49)	15.0	16.5 (.65)
PG9	33.5 (1.32)	25.5 (1.00)	8.0 (.31)	15.2 (.60)	19.0	21.0 (.83)
PG11	36.0 (1.42)	28.5 (1.12)	8.0 (.31)	18.6 (.73)	22.0	24.5 (.96)
PG13.5	38.5 (1.52)	29.7 (1.17)	9.0 (.35)	20.4 (.80)	24.0	26.6 (1.05)
PG16	42.0 (1.65)	32.0 (1.26)	10.0 (.39)	22.5 (.89)	27.0	30.0 (1.18)
PG21	47.5 (1.87)	36.5 (1.44)	11.0 (.43)	28.3 (1.11)	33.0	36.6 (1.44)
PG29	53.5 (2.11)	43.5 (1.71)	11.0 (.43)	37.0 (1.46)	42.0	46.3 (1.82)
PG36	66.5 (2.62)	54.0 (2.13)	13.0 (.51)	47.0 (1.85)	53.0	58.0 (2.28)
PG42	65.8 (2.59)	53.5 (2.11)	13.0 (.51)	54.0 (2.13)	60.0	66.0 (2.60)
PG48	69.5 (2.74)	55.7 (2.19)	14.0 (.55)	59.3 (2.33)	65.0	71.0 (2.80)
NPT3/8"	44.2 (1.74)	29.0 (1.14)	15.0 (.59)	17.2 (.68)	22.0	24.3 (.96)
NPT1/2"	46.0 (1.81)	31.3 (1.23)	15.0 (.59)	21.3 (.84)	27.0	29.6 (1.17)
NPT3/4"	51.6 (2.03)	36.7 (1.44)	15.0 (.59)	26.7 (1.05)	33.0	36.1 (1.42)

<sup>1</sup> For installation into nonthreaded holes with Locknuts. Please refer to page 5 for installation instructions.

<sup>2</sup> Order Locknuts separately if required. Please refer to page 54 for more information.

<sup>3</sup> Order Seal Rings separately if required. Please refer to page 52 for more information.

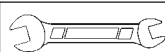

#### Installation

To install, we recommend the use of Socket (Refer to page 53), Metric Open-end or Adjustable Wrenches. Please refer to column "E" in the Dimensions Table for sizes.



## STANDARD STRAIGHT-THROUGH

### Brass, Nickel Plated (BN)

- IP68 (NEMA 1, 2, 3, 3R, 4, 4X, 5, 6, 12, 13).
- PG, NPT standard. Metric available.
- Preinstalled Perbunan (PR) Seal Rings (All sizes).



Temperature Ranges	
Body	Sealing Sleeve
Brass, Nickel Plated (BN)	Neoprene (NE)
-40 to 300°C (-40 to 572°F)	-40 to 100°C (-40 to 212°F)

### Brass, Nickel Plated (BN) with Neoprene (NE) Sealing Sleeve

Liquid Tight Strain Reliefs (Cord Grips)								Locknuts <sup>2</sup> Brass, Nickel Plated (BN)	
Type	Cat. No.	Std. Pk.	Cable Dia.		Mtg. Hole Dia. <sup>1</sup>		Nearest Drill Size	Cat. No.	Std. Pk.
			mm	(in.)	mm	(in.)			
PG7-SSBN - [ ] NE 05	<b>80.100</b>	100	2.0 - 5.0	(.08 - .20)	13.0	(.51)	33/64	<b>86.500</b>	100
PG7-SSBN - [ ] NE 06	<b>80.101</b>	100	3.0 - 6.5	(.12 - .26)	13.0	(.51)	33/64	<b>86.500</b>	100
PG9-SSBN - [ ] NE 06	<b>80.102</b>	100	2.0 - 6.0	(.08 - .24)	15.5	(.61)	39/64	<b>86.501</b>	100
PG9-SSBN - [ ] NE 08	<b>80.103</b>	100	4.0 - 8.0	(.16 - .31)	15.5	(.61)	39/64	<b>86.501</b>	100
PG11-SSBN - [ ] NE 07	<b>80.104</b>	50	3.0 - 7.0	(.12 - .28)	19.0	(.75)	3/4	<b>86.502</b>	50
PG11-SSBN - [ ] NE 10	<b>80.105</b>	50	5.0 - 10.0	(.20 - .39)	19.0	(.75)	3/4	<b>86.502</b>	50
PG13.5-SSBN - [ ] NE 09	<b>80.106</b>	50	5.0 - 9.0	(.20 - .35)	21.0	(.83)	53/64	<b>86.503</b>	50
PG13.5-SSBN - [ ] NE 12	<b>80.107</b>	50	6.0 - 12.0	(.24 - .47)	21.0	(.83)	53/64	<b>86.503</b>	50
PG16-SSBN - [ ] NE 12	<b>80.108</b>	50	7.0 - 12.0	(.28 - .47)	23.0	(.91)	29/32	<b>86.504</b>	50
PG16-SSBN - [ ] NE 14	<b>80.109</b>	50	10.0 - 14.0	(.39 - .55)	23.0	(.91)	29/32	<b>86.504</b>	50
PG21-SSBN - [ ] NE 16	<b>80.110</b>	50	9.0 - 16.0	(.35 - .63)	29.0	(1.14)	1-9/64	<b>86.505</b>	50
PG21-SSBN - [ ] NE 18	<b>80.111</b>	50	13.0 - 18.0	(.51 - .71)	29.0	(1.14)	1-9/64	<b>86.505</b>	50
PG29-SSBN - [ ] NE 20	<b>80.112</b>	25	12.0 - 20.0	(.47 - .79)	37.5	(1.48)	1-31/64	<b>86.506</b>	25
PG29-SSBN - [ ] NE 25	<b>80.113</b>	25	18.0 - 25.0	(.71 - .98)	37.5	(1.48)	1-31/64	<b>86.506</b>	25
PG36-SSBN - [ ] NE 26	<b>80.114</b>	10	20.0 - 26.0	(.79 - 1.02)	47.5	(1.87)	1-7/8	<b>86.507</b>	10
PG36-SSBN - [ ] NE 32	<b>80.115</b>	10	22.0 - 32.0	(.87 - 1.26)	47.5	(1.87)	1-7/8	<b>86.507</b>	10
PG42-SSBN - [ ] NE 38	<b>80.117</b>	5	30.0 - 38.0	(1.18 - 1.50)	54.5	(2.15)	2-5/32	<b>86.508</b>	5
PG48-SSBN - [ ] NE 44	<b>80.119</b>	5	34.0 - 44.0	(1.34 - 1.73)	60.0	(2.36)	2-3/8	<b>86.509</b>	5
NPT3/8-SSBN - [ ] NE 06	<b>80.120</b>	50	2.0 - 6.0	(.08 - .24)	17.5	(.69)	11/16	<b>86.541</b>	50
NPT3/8-SSBN - [ ] NE 08	<b>80.121</b>	50	4.0 - 8.0	(.16 - .31)	17.5	(.69)	11/16	<b>86.541</b>	50
NPT1/2-SSBN - [ ] NE 09	<b>80.122</b>	50	5.0 - 9.0	(.20 - .35)	21.5	(.85)	27/32	<b>86.542</b>	50
NPT1/2-SSBN - [ ] NE 12	<b>80.123</b>	50	6.0 - 12.0	(.24 - .47)	21.5	(.85)	27/32	<b>86.542</b>	50
NPT3/4-SSBN - [ ] NE 16	<b>80.124</b>	25	9.0 - 16.0	(.35 - .63)	27.0	(1.06)	1-1/16	<b>86.543</b>	25
NPT3/4-SSBN - [ ] NE 18	<b>80.125</b>	25	13.0 - 18.0	(.51 - .71)	27.0	(1.06)	1-1/16	<b>86.543</b>	25

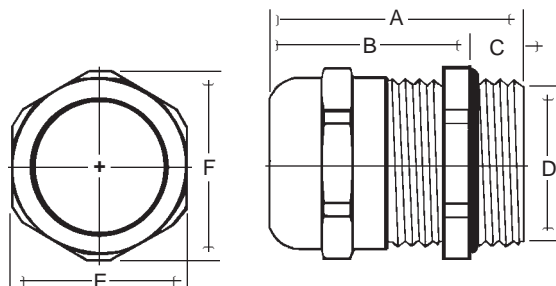

#### Dimensions mm (in.)

Size	A	B	C	D	E	F
PG7	24.0 (.94)	19.3 (.76)	5.0 (.20)	12.5 (.49)	14.0	15.5 (.61)
PG9	28.8 (1.13)	22.0 (.87)	6.0 (.24)	15.2 (.60)	17.0	18.9 (.74)
PG11	29.2 (1.15)	22.5 (.89)	6.0 (.24)	18.6 (.73)	20.0	22.2 (.87)
PG13.5	29.5 (1.16)	23.0 (.91)	6.5 (.26)	20.4 (.80)	22.0	24.5 (.96)
PG16	31.0 (1.22)	24.5 (.96)	6.5 (.26)	22.5 (.89)	24.0	26.7 (1.05)
PG21	34.3 (1.35)	27.7 (1.09)	7.0 (.28)	28.3 (1.11)	30.0	33.5 (1.32)
PG29	41.0 (1.61)	32.0 (1.26)	8.0 (.31)	37.0 (1.46)	40.0	43.5 (1.71)
PG36	46.2 (1.82)	38.0 (1.50)	9.0 (.35)	47.0 (1.85)	50.0	54.0 (2.13)
PG42	48.3 (1.90)	39.3 (1.55)	10.0 (.39)	54.0 (2.13)	57.0	61.0 (2.40)
PG48	50.4 (1.98)	41.3 (1.63)	10.0 (.39)	59.3 (2.33)	64.0	69.0 (2.72)
NPT3/8"	37.0 (1.46)	16.9 (.67)	15.0 (.59)	17.1 (.67)	17.0	19.0 (.75)
NPT1/2"	37.5 (1.48)	24.5 (.96)	13.0 (.51)	21.3 (.84)	24.0	26.7 (1.05)
NPT3/4"	40.7 (1.60)	27.7 (1.09)	13.0 (.51)	26.7 (1.05)	30.0	33.5 (1.32)

<sup>1</sup> For installation into nonthreaded holes with Locknuts. Please refer to page 5 for installation instructions.

<sup>2</sup> Order Locknuts separately if required. Please refer to page 54 for more information.



#### Installation

To install, we recommend the use of Socket (Refer to page 53), Metric Open-end or Adjustable Wrenches. Please refer to column "E" in the Dimensions Table for sizes.

# STANDARD BEND PROTECTION

## Polyamide (PA)

- IP68 (NEMA1, 2, 3, 3R, 4, 4X, 5, 6, 12, 13).
- PG, NPT standard. Metric available.
- Integral Sealing Ridges (Only PG7 to PG21 and NPT3/8 to NPT3/4). Order Seal Rings separately if required.
- Standard Color: Light Gray and Black.



Temperature Ranges	
Body	Sealing Sleeve
Polyamide (PA)	Neoprene (NE)
-20 to 100°C (-4 to 212°F)	-40 to 100°C (-40 to 212°F)

## Polyamide (PA) with Neoprene (NE) Sealing Sleeve

Liquid Tight Strain Reliefs (Cord Grips)									Seal Rings <sup>3</sup> Polyethylene (PE)		Locknuts <sup>2</sup> Polyamide (PA)			
Type	NE	Cat. No.	Cat. No.		Std. Pk.	Cable Dia.		Mtg. Hole Dia. <sup>1</sup>	Nearest Drill Size	Cat. No. Opaque	Std. Pk.	Cat. No.		Std. Pk.
			Lt. Gray	Black		mm	(in.)					mm	(in.)	
PG7-SBPA - <input type="checkbox"/>	<input type="checkbox"/>	NE 06	80.300	80.310	50	3.5 - 6.5	(.14 - .26)	13.0 (.51)	33/64	86.600	100	86.000	86.021	100
PG9-SBPA - <input type="checkbox"/>	<input type="checkbox"/>	NE 08	80.301	80.311	50	4.0 - 8.0	(.16 - .31)	15.5 (.61)	39/64	86.601	100	86.001	86.022	100
PG11-SBPA - <input type="checkbox"/>	<input type="checkbox"/>	NE 10	80.302	80.312	50	5.0 - 10.0	(.20 - .39)	19.0 (.74)	3/4	86.602	100	86.002	86.023	100
PG13.5-SBPA - <input type="checkbox"/>	<input type="checkbox"/>	NE 12	80.303	80.313	50	6.0 - 12.0	(.24 - .47)	21.0 (.82)	53/64	86.603	100	86.003	86.024	100
PG16-SBPA - <input type="checkbox"/>	<input type="checkbox"/>	NE 14	80.304	80.314	25	10.0 - 14.0	(.39 - .55)	23.0 (.90)	29/32	86.604	50	86.004	86.025	50
PG21-SBPA - <input type="checkbox"/>	<input type="checkbox"/>	NE 18	80.305	80.315	25	13.0 - 18.0	(.51 - .71)	29.0 (1.14)	1-9/64	86.605	50	86.005	86.026	50
NPT3/8-SBPA - <input type="checkbox"/>	<input type="checkbox"/>	NE 10	80.306	80.316	50	5.0 - 10.0	(.20 - .39)	17.5 (.69)	11/16	80.602	50	86.061	86.081	50
NPT1/2-SBPA - <input type="checkbox"/>	<input type="checkbox"/>	NE 14	80.307	80.317	50	10.0 - 14.0	(.39 - .55)	21.5 (.85)	27/32	80.603	50	86.062	86.082	50
NPT3/4-SBPA - <input type="checkbox"/>	<input type="checkbox"/>	NE 18	80.308	80.318	25	13.0 - 18.0	(.51 - .71)	27.0 (1.06)	1-1/16	80.605	25	86.063	86.083	25

Body Color, Example: Light Gray  or Black

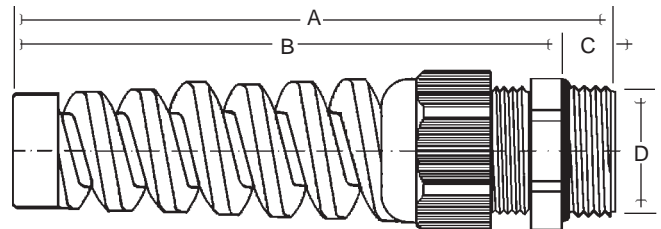
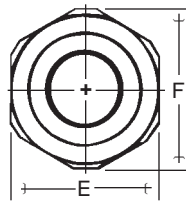

### Dimensions mm (in.)

Size	A	B	C	D	E	F
PG7	68.0 (2.67)	60.0 (2.36)	8.0 (.31)	12.5 (.49)	15.0	16.5 (.65)
PG9	80.0 (3.14)	72.0 (2.83)	8.0 (.31)	15.2 (.59)	19.0	21.0 (.82)
PG11	92.0 (3.62)	84.0 (3.30)	8.0 (.31)	18.6 (.73)	22.0	24.4 (.96)
PG13.5	104.5 (4.11)	95.5 (3.75)	9.0 (.35)	20.4 (.80)	24.0	26.6 (1.05)
PG16	119.0 (4.68)	109.0 (4.29)	10.0 (.39)	22.5 (.88)	27.0	30.0 (1.18)
PG21	138.0 (5.43)	128.0 (5.03)	11.0 (.43)	28.3 (1.11)	33.0	36.6 (1.44)
NPT3/8"	92.0 (3.62)	84.0 (3.30)	15.0 (.59)	17.2 (.68)	22.0	24.3 (.96)
NPT1/2"	119.0 (4.68)	109.0 (4.29)	15.0 (.59)	21.3 (.84)	27.0	29.6 (1.17)
NPT3/4"	138.0 (5.43)	128.0 (5.03)	15.0 (.59)	26.7 (1.05)	33.0	36.1 (1.42)

<sup>1</sup> For installation into nonthreaded holes with Locknuts. Please refer to page 5 for installation instructions.

<sup>2</sup> Order Locknuts separately if required. Please refer to page 54 for more information.

<sup>3</sup> Order Seal Rings separately if required. Please refer to page 52 for more information.

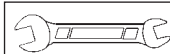

#### Installation

To install, we recommend the use of Socket (Refer to page 53), Metric Open-end or Adjustable Wrenches. Please refer to column "E" in the Dimensions Table for sizes.

## STANDARD PULL / BEND PROTECTION

- IP55 (NEMA 1, 2, 5, 12, 13).
- PG standard.
- Standard Color: Light Gray Polyamide (PA) or Brass, Nickel Plated (BN).
- We recommend the use of Polyethylene (PE) Seal Rings with Polyamide (PA) Cord Grips and Perbunan (PR) Seal Rings with Brass, Nickel Plated (BN) Cord Grips. Order Seal Rings separately. Refer to page 52 for technical and ordering information.
- Order Locknuts separately if required. We recommend the use of Polyamide (PA) Locknuts with Polyamide (PA) Cord Grips and Brass, Nickel Plated (BN) Locknuts with Brass, Nickel Plated (BN) Cord Grips. Refer to page 54 for technical and ordering information.

Temperature Ranges	
Body	Sealing Ring
Polyamide (PA) -20 to 100°C (-4 to 212°F)	Rubber (RU) -20 to 60°C (-4 to 140°F)
Brass, Nickel Plated (BN) -40 to 300°C (-40 to 572°F)	Neoprene (NE) -40 to 100°C (-40 to 212°F)



**Polyamide (PA)**  
with Rubber (RU) Sealing Ring



**Brass, Nickel Plated (BN)**  
with Neoprene (NE) Sealing Ring

### Liquid Tight Strain Reliefs (Cord Grips)

Cable Dia. mm (in.)	Mtg. Hole Dia. <sup>1</sup> mm (in.)	Nearest Drill Size	Type	Cat. No.	Std. Pk.
<b>Polyamide (PA)</b>					
5.5 - 7.5 (.20 - .30)	15.5 (.61)	39/64	PG9-SSPA - LG RU 07	<b>80.200</b>	50
7.5 - 9.5 (.30 - .37)	19.0 (.75)	3/4	PG11-SSPA - LG RU 09	<b>80.201</b>	50
9.0 - 11.0 (.35 - .43)	21.0 (.83)	53/64	PG13.5-SSPA - LG RU 11	<b>80.202</b>	50
10.0 - 13.0 (.39 - .51)	23.0 (.91)	29/32	PG16-SSPA - LG RU 13	<b>80.203</b>	25
13.0 - 17.5 (.51 - .69)	29.0 (1.14)	1-9/64	PG21-SSPA - LG RU 17	<b>80.204</b>	25
18.0 - 25.0 (.71 - .98)	37.5 (1.48)	1-31/64	PG29-SSPA - LG RU 25	<b>80.205</b>	20
<b>Brass, Nickel Plated (BN)</b>					
6.0 - 9.0 (.24 - .35)	15.5 (.61)	39/64	PG9-SSBN - [ ] NE 09	<b>80.206</b>	50
8.0 - 12.0 (.31 - .47)	19.0 (.75)	3/4	PG11-SSBN - [ ] NE 12	<b>80.207</b>	50
9.0 - 14.0 (.35 - .55)	21.0 (.83)	53/64	PG13.5-SSBN - [ ] NE 14	<b>80.208</b>	50
10.0 - 16.0 (.39 - .62)	23.0 (.91)	29/32	PG16-SSBN - [ ] NE 16	<b>80.209</b>	25
14.0 - 21.0 (.55 - .82)	29.0 (1.14)	1-9/64	PG21-SSBN - [ ] NE 21	<b>80.210</b>	25
18.0 - 30.0 (.70 - 1.18)	37.5 (1.48)	1-31/64	PG29-SSBN - [ ] NE 30	<b>80.211</b>	20

Type	Cat. No.	Std. Pk.
PG9-SSPA - LG RU 07	<b>80.200</b>	50
PG11-SSPA - LG RU 09	<b>80.201</b>	50
PG13.5-SSPA - LG RU 11	<b>80.202</b>	50
PG16-SSPA - LG RU 13	<b>80.203</b>	25
PG21-SSPA - LG RU 17	<b>80.204</b>	25
PG29-SSPA - LG RU 25	<b>80.205</b>	20

Type	Cat. No.	Std. Pk.
PG9-SSBN - [ ] NE 09	<b>80.206</b>	50
PG11-SSBN - [ ] NE 12	<b>80.207</b>	50
PG13.5-SSBN - [ ] NE 14	<b>80.208</b>	50
PG16-SSBN - [ ] NE 16	<b>80.209</b>	25
PG21-SSBN - [ ] NE 21	<b>80.210</b>	25
PG29-SSBN - [ ] NE 30	<b>80.211</b>	20

### Polyamide (PA)

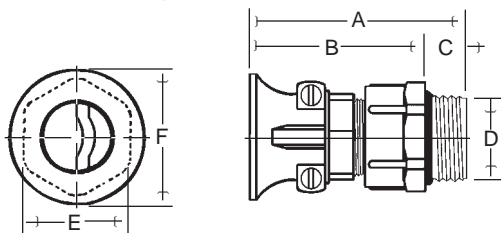

### Brass, Nickel Plated (BN)

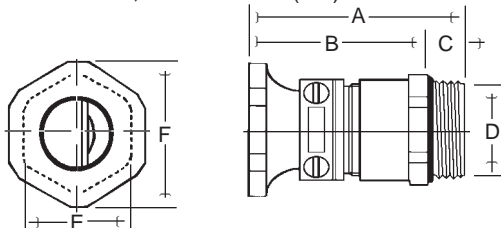

### Dimensions mm (in.)

Size	A	B	C	D	E	F
<b>Polyamide (PA)</b>						
PG9	50.0 (1.97)	42.0 (1.65)	8.0 (.31)	15.2 (.60)	19.0	21.0 (.83)
PG11	52.0 (2.05)	44.0 (1.73)	8.0 (.31)	18.6 (.73)	22.0	24.5 (.96)
PG13.5	59.0 (2.32)	49.5 (1.95)	9.5 (.37)	20.4 (.80)	24.0	26.6 (1.05)
PG16	64.0 (2.52)	54.0 (2.13)	10.0 (.39)	22.5 (.89)	27.0	30.0 (1.18)
PG21	72.0 (2.83)	61.0 (2.40)	11.0 (.43)	28.3 (1.11)	32.0	36.6 (1.44)
PG29	80.0 (3.15)	69.0 (2.72)	11.0 (.43)	37.0 (1.46)	42.0	46.3 (1.82)
<b>Brass, Nickel Plated (BN)</b>						
PG9	34.0 (1.34)	28.0 (1.10)	6.0 (.24)	15.2 (.60)	17.0	18.9 (.74)
PG11	35.0 (1.38)	29.0 (1.14)	6.0 (.24)	18.6 (.73)	20.0	22.2 (.87)
PG13.5	36.5 (1.44)	30.0 (1.18)	6.5 (.26)	20.4 (.80)	22.0	24.5 (.96)
PG16	37.5 (1.48)	31.0 (1.22)	6.5 (.26)	22.5 (.89)	24.0	32.0 (1.26)
PG21	43.0 (1.69)	36.0 (1.42)	7.0 (.28)	28.3 (1.11)	30.0	38.0 (1.50)
PG29	49.0 (1.93)	41.0 (1.61)	8.0 (.31)	37.0 (1.46)	40.0	50.0 (1.97)

<sup>1</sup> For installation into nonthreaded holes with Locknuts. Please refer to page 5 for installation instructions.

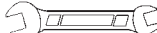
**Installation**  
 To install, we recommend the use of Socket (Refer to page 53), Metric Open-end or Adjustable Wrenches. Please refer to column "E" in the Dimensions Table for sizes.

# STANDARD MULTI-CONDUCTOR

## Polyamide (PA)

- IP54 (NEMA 1, 2, 5, 12, 13).
- PG standard, NPT available.
- Integral Sealing Ridges (Only PG11 to PG21). Order Seal Rings separately if required. Refer to page 52.
- Preinstalled Perbunan (PR) Seal Rings (Only PG29).
- Plug unused holes with Sealing Plugs. Refer to page 52.
- Standard Color: Light Gray and Black.

Temperature Ranges	
Body	Sealing Insert
Polyamide (PA)	PVC Polyvinylchloride (PV)
-20 to 100°C (-4 to 212°F)	-20 to 80°C (-4 to 176°F)



## Polyamide (PA) with PVC Polyvinylchloride (PV) Sealing Insert

Liquid Tight Strain Reliefs (Cord Grips)								Seal Rings <sup>3</sup> Polyethylene (PE)		Locknuts <sup>2</sup> Polyamide (PA)			
Type		Cat. No.		Std. Pk.	No. of Cables	Cable Dia. mm (in.)	Mtg. Hole Dia. <sup>1</sup> mm (in.)	Nearest Drill Size	Cat. No. Opaque	Std. Pk.	Cat. No.		Std. Pk.
		Lt. Gray	Black								Lt. Gray	Black	
PG11-SMPA -	<input type="checkbox"/> PV 04	<b>80.400</b>	<b>80.430</b>	50	2	4.0 (.16)	19.0 (.75)	3/4	<b>86.602</b>	100	<b>86.002</b>	<b>86.023</b>	100
PG11-SMPA -	<input type="checkbox"/> PV 04	<b>80.401</b>	<b>80.431</b>	50	3	4.0 (.16)	19.0 (.75)	3/4	<b>86.602</b>	100	<b>86.002</b>	<b>86.023</b>	100
PG11-SMPA -	<input type="checkbox"/> PV 05	<b>80.402</b>	<b>80.432</b>	50	3	5.0 (.20)	19.0 (.75)	3/4	<b>86.602</b>	100	<b>86.002</b>	<b>86.023</b>	100
PG11-SMPA -	<input type="checkbox"/> PV 00	<b>80.422</b>	<b>80.452</b>	50		<u>Solid Core Insert</u>	19.0 (.75)	3/4	<b>86.602</b>	100	<b>86.002</b>	<b>86.023</b>	100
PG13.5-SMPA -	<input type="checkbox"/> PV 06	<b>80.403</b>	<b>80.433</b>	50	2	6.0 (.24)	21.0 (.82)	53/64	<b>86.603</b>	100	<b>86.003</b>	<b>86.024</b>	100
PG13.5-SMPA -	<input type="checkbox"/> PV 06	<b>80.404</b>	<b>80.434</b>	50	3	6.0 (.16)	21.0 (.82)	53/64	<b>86.603</b>	100	<b>86.003</b>	<b>86.024</b>	100
PG13.5-SMPA -	<input type="checkbox"/> PV 05	<b>80.405</b>	<b>80.435</b>	50	3	5.0 (.20)	21.0 (.82)	53/64	<b>86.603</b>	100	<b>86.003</b>	<b>86.024</b>	100
PG13.5-SMPA -	<input type="checkbox"/> PV 00	<b>80.423</b>	<b>80.453</b>	50		<u>Solid Core Insert</u>	21.0 (.82)	53.64	<b>86.603</b>	100	<b>86.003</b>	<b>86.024</b>	100
PG16-SMPA -	<input type="checkbox"/> PV 04	<b>80.406</b>	<b>80.436</b>	50	2	4.0 (.16)	23.0 (.91)	29/32	<b>86.604</b>	50	<b>86.004</b>	<b>86.025</b>	50
PG16-SMPA -	<input type="checkbox"/> PV 06	<b>80.407</b>	<b>80.437</b>	50	2	6.0 (.24)	23.0 (.91)	29/32	<b>86.604</b>	50	<b>86.004</b>	<b>86.025</b>	50
PG16-SMPA -	<input type="checkbox"/> PV 04	<b>80.408</b>	<b>80.438</b>	50	3	4.0 (.16)	23.0 (.91)	29/32	<b>86.604</b>	50	<b>86.004</b>	<b>86.025</b>	50
PG16-SMPA -	<input type="checkbox"/> PV 05	<b>80.409</b>	<b>80.439</b>	50	3	5.0 (.20)	23.0 (.91)	29/32	<b>86.604</b>	50	<b>86.004</b>	<b>86.025</b>	50
PG16-SMPA -	<input type="checkbox"/> PV 06	<b>80.410</b>	<b>80.440</b>	50	3	6.5 (.26)	23.0 (.91)	29/32	<b>86.604</b>	50	<b>86.004</b>	<b>86.025</b>	50
PG16-SMPA -	<input type="checkbox"/> PV 05	<b>80.411</b>	<b>80.441</b>	50	4	5.0 (.20)	23.0 (.91)	29/32	<b>86.604</b>	50	<b>86.004</b>	<b>86.025</b>	50
PG16-SMPA -	<input type="checkbox"/> PV 06	<b>80.412</b>	<b>80.442</b>	50	4	6.0 (.24)	23.0 (.91)	29/32	<b>86.604</b>	50	<b>86.004</b>	<b>86.025</b>	50
PG16-SMPA -	<input type="checkbox"/> PV 04	<b>80.413</b>	<b>80.443</b>	50	5	4.0 (.16)	23.0 (.91)	29/32	<b>86.604</b>	50	<b>86.004</b>	<b>86.025</b>	50
PG16-SMPA -	<input type="checkbox"/> PV 00	<b>80.424</b>	<b>80.454</b>	50		<u>Solid Core Insert</u>	23.0 (.91)	29/32	<b>86.604</b>	50	<b>86.004</b>	<b>86.025</b>	50
PG21-SMPA -	<input type="checkbox"/> PV 07	<b>80.414</b>	<b>80.444</b>	25	2	7.0 (.28)	29.0 (1.14)	1-9/64	<b>86.605</b>	50	<b>86.005</b>	<b>86.026</b>	50
PG21-SMPA -	<input type="checkbox"/> PV 08	<b>80.415</b>	<b>80.445</b>	25	2	8.0 (.31)	29.0 (1.14)	1-9/64	<b>86.605</b>	50	<b>86.005</b>	<b>86.026</b>	50
PG21-SMPA -	<input type="checkbox"/> PV 09	<b>80.416</b>	<b>80.446</b>	25	2	9.0 (.35)	29.0 (1.14)	1-9/64	<b>86.605</b>	50	<b>86.005</b>	<b>86.026</b>	50
PG21-SMPA -	<input type="checkbox"/> PV 07	<b>80.417</b>	<b>80.447</b>	25	3	7.0 (.28)	29.0 (1.14)	1-9/64	<b>86.605</b>	50	<b>86.005</b>	<b>86.026</b>	50
PG21-SMPA -	<input type="checkbox"/> PV 08	<b>80.418</b>	<b>80.448</b>	25	3	8.0 (.31)	29.0 (1.14)	1-9/64	<b>86.605</b>	50	<b>86.005</b>	<b>86.026</b>	50
PG21-SMPA -	<input type="checkbox"/> PV 00	<b>80.425</b>	<b>80.455</b>	25		<u>Solid Core Insert</u>	29.0 (1.14)	1-9/64	<b>86.605</b>	50	<b>86.005</b>	<b>86.026</b>	50
PG29-SMPA -	<input type="checkbox"/> PV 05	<b>80.421</b>	<b>80.451</b>	25	8	5.0 (.20)	37.5 (1.14)	1-31/64	<b>Preinstalled</b>		<b>86.006</b>	<b>86.027</b>	25
PG29-SMPA -	<input type="checkbox"/> PV 00	<b>80.426</b>	<b>80.456</b>	25		<u>Solid Core Insert</u>	37.5 (1.14)	1-31/64		<b>86.006</b>	<b>86.027</b>	25	

Body Color, Example: Light Gray [LG] or Black [BK]

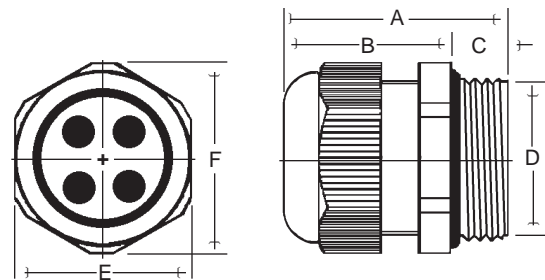

### Dimensions mm (in.)

Size	A	B	C	D	E	F
PG11	36.0 (1.42)	28.5 (1.12)	8.0 (.31)	18.6 (.73)	22.0	24.5 (.96)
PG13.5	38.5 (1.52)	29.7 (1.17)	9.0 (.35)	20.4 (.80)	24.0	26.6 (1.05)
PG16	42.0 (1.65)	32.0 (1.26)	10.0 (.39)	22.5 (.89)	27.0	30.0 (1.18)
PG21	47.5 (1.87)	36.5 (1.44)	11.0 (.43)	28.3 (1.11)	33.0	36.6 (1.44)
PG29	53.5 (2.11)	43.5 (1.71)	11.0 (.43)	37.0 (1.46)	42.0	46.3 (1.82)

<sup>1</sup> For installation into nonthreaded holes with Locknuts. Please refer to page 5 for installation instructions.

<sup>2</sup> Order Locknuts separately if required. Please refer to page 54 for more information.

<sup>3</sup> Order Seal Rings separately if required. Please refer to page 52 for more information.

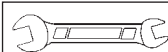

#### Installation

To install, we recommend the use of Socket (Refer to page 53), Metric Open-end or Adjustable Wrenches. Please refer to column "E" in the Dimensions Table for sizes.

## STANDARD FLAT CABLE

### Polyamide (PA)

- IP 55 (NEMA 1, 2, 5, 12, 13).
- PG standard.
- Galvanized Steel Washers.
- Standard Color: Light Gray.
- Sealing Insert Color: Black.
- We recommend the use of Polyethylene (PE) Seal Rings with the Cord Grips shown on this page. Please order separately. Refer to column below and page 52 for additional information.
- Other sizes available, please contact Altech.

Temperature Ranges	
Body	Sealing Insert
Polyamide (PA)	Neoprene (NE)
-20 to 100°C (-4 to 212°F)	-40 to 100°C (-40 to 212°F)

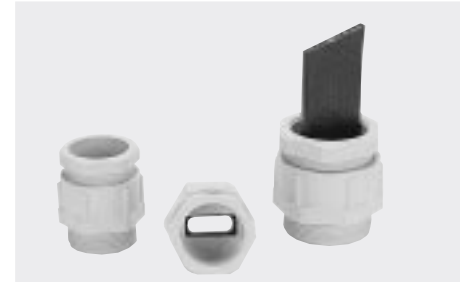

### Polyamide (PA) with Neoprene (NE) Oval Opening Sealing Insert

Type	Cat.No.	Std. Pk.	Opening Dims. H x W mm (in.)	Mtg. Hole Dia. <sup>1</sup> mm (in.)	Nearest Drill Size	Seal Rings <sup>3</sup> Polyethylene (PE)		Locknuts <sup>2</sup> Polyamide (PA)	
						Cat.No. Opaque	Std. Pk.	Cat.No. Lt. Gray	Std. Pk.
PG16-SFPA - LG NE 15	80.500	50	5.0 x 15.0 (.20 x .59)	23.0 (.91)	29/32	86.604	50	86.004	50
PG21-SFPA - LG NE 18	80.501	50	6.0 x 18.0 (.24 x .71)	29.0 (1.14)	1-9/64	86.605	50	86.005	50
PG21-SFPA - LG NE 19	80.502	50	7.5 x 19.0 (.30 x .75)	29.0 (1.14)	1-9/64	86.605	50	86.005	50
PG21-SFPA - LG NE 21	80.503	50	11.0 x 21.0 (.43 x .83)	29.0 (1.14)	1-9/64	86.605	50	86.005	50
PG29-SFPA - LG NE 24	80.504	25	6.0 x 24.0 (.24 x .94)	37.5 (1.48)	1-31/64	86.606	20	86.006	25
PG29-SFPA - LG NE 28	80.505	25	6.0 x 28.0 (.24 x 1.10)	37.5 (1.48)	1-31/64	86.606	20	86.006	25
PG29-SFPA - LG NE 30	80.506	25	7.0 x 30.0 (.28 x 1.18)	37.5 (1.48)	1-31/64	86.606	20	86.006	25
PG29-SFPA - LG NE 22	80.507	25	8.0 x 22.0 (.31 x .87)	37.5 (1.48)	1-31/64	86.606	20	86.006	25
PG29-SFPA - LG NE 26	80.508	25	9.0 x 26.0 (.35 x 1.02)	37.5 (1.48)	1-31/64	86.606	20	86.006	25
PG29-SFPA - LG NE 30	80.509	25	10.5 x 30.0 (.41 x 1.18)	37.5 (1.48)	1-31/64	86.606	20	86.006	25
PG36-SFPA - LG NE 32	80.511	10	6.0 x 32.0 (.24 x 1.26)	47.5 (1.87)	1-7/8	86.607	10	86.007	10
PG36-SFPA - LG NE 35	80.512	10	6.0 x 35.0 (.24 x 1.38)	47.5 (1.87)	1-7/8	86.607	10	86.007	10
PG36-SFPA - LG NE 38	80.513	10	7.0 x 38.0 (.28 x 1.50)	47.5 (1.87)	1-7/8	86.607	10	86.007	10
PG36-SFPA - LG NE 34	80.514	10	8.0 x 34.0 (.31 x 1.34)	47.5 (1.87)	1-7/8	86.607	10	86.007	10
PG36-SFPA - LG NE 32	80.515	10	10.0 x 32.0 (.39 x 1.26)	47.5 (1.87)	1-7/8	86.607	10	86.007	10
PG36-SFPA - LG NE 37	80.516	10	12.5 x 37.0 (.49 x 1.46)	47.5 (1.87)	1-7/8	86.607	10	86.007	10
PG42-SFPA - LG NE 40	80.518	5	6.0 x 40.0 (.24 x 1.57)	54.5 (2.15)	2-5/32	86.608	5	86.008	5
PG42-SFPA - LG NE 40	80.519	5	7.5 x 40.0 (.30 x 1.57)	54.5 (2.15)	2-5/32	86.608	5	86.008	5
PG42-SFPA - LG NE 39	80.520	5	11.5 x 39.0 (.45 x 1.54)	54.5 (2.15)	2-5/32	86.608	5	86.008	5
PG42-SFPA - LG NE 41	80.521	5	13.5 x 41.0 (.53 x 1.61)	54.5 (2.15)	2-5/32	86.608	5	86.008	5
PG48-SFPA - LG NE 49	80.522	5	7.0 x 49.0 (.28 x 1.93)	60.0 (2.36)	2-3/8	86.609	5	86.009	5
PG48-SFPA - LG NE 44	80.523	5	10.0 x 44.0 (.39 x 1.73)	60.0 (2.36)	2-3/8	86.609	5	86.009	5
PG48-SFPA - LG NE 44	80.524	5	14.0 x 44.0 (.55 x 1.73)	60.0 (2.36)	2-3/8	86.609	5	86.009	5

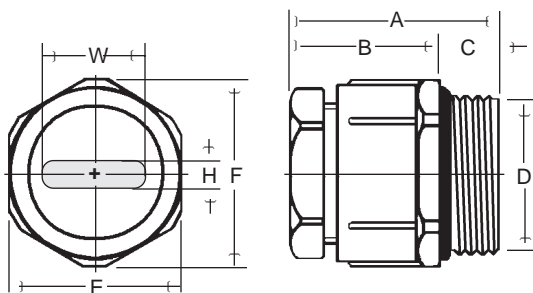

#### Dimensions mm (in.)

Size	A	B	C	D	E	F
PG16	41.0 (1.61)	33.0 (1.30)	10.0 (.39)	22.5 (.89)	27.0	29.0 (1.14)
PG21	43.5 (1.71)	36.0 (1.42)	11.0 (.43)	28.3 (1.11)	32.0	35.5 (1.40)
PG29	46.0 (1.81)	38.0 (1.50)	11.0 (.43)	37.0 (1.46)	42.0	45.5 (1.79)
PG36	57.0 (2.24)	42.4 (1.67)	13.0 (.51)	47.0 (1.85)	53.0	57.0 (2.24)
PG42	61.0 (2.40)	50.0 (1.97)	13.0 (.51)	54.0 (2.13)	60.0	65.0 (2.56)
PG48	60.0 (2.36)	50.0 (1.97)	14.0 (.55)	59.3 (2.33)	65.0	70.0 (2.76)

#### \*Tolerances

Minimum cable size should not be less than .5mm (.02 in.) in length and height than opening in Cord Grip.

<sup>1</sup> For installation into nonthreaded holes with Locknuts. Please refer to page 5 for installation instructions.

<sup>2</sup> Order Locknuts separately if required. Please refer to page 54 for more information.

<sup>3</sup> Order Seal Rings separately if required. Please refer to page 52 for more information.

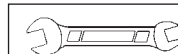

#### Installation

To install, we recommend the use of Socket (Refer to page 53), Metric Open-end or Adjustable Wrenches. Please refer to column "E" in the Dimensions Table for sizes.





---

Excellent for demanding applications, special requirements, and tough environmental conditions. High Performance Liquid Tight Strain Reliefs (Cord Grips) can be used with cables, cords, etc. in a wide range of diameters.

Select the most suitable Cord Grip for your application from a variety of Functions, Body and Tubular Sealing Insert material combinations.

#### **Body Materials**

- Polyamide (PA)
- PVDF Polyvinylidene Fluoride (PO)
- Brass, Nickel Plated (BN)
- Stainless Steel (SS)

#### **Tubular Sealing Insert Materials**

- PVC Polyvinylchloride (PV)
- Santoprene (ST)
- TPE Polyolefin (TP)
- Silicone (SI)

#### **Functions**

- Straight-Through
- Increased Strain Relief
- Bend
- Pull / Bend
- Multi-Conductor
- EMI / RFI
- Flat Cable

#### **Protection Rating**

Up to IP68  
(NEMA 1, 2, 3, 3R, 4, 4X, 5, 6, 12, 13)

#### **Pressure Rating**

Up to 10 Bar (140 psi)

---

# HIGH PERFORMANCE



High Performance Cord Grips are supplied complete and ready to install. The illustration below shows the various components of the Nonmetallic and the Metal Straight-Through Cord Grips. Basic functions of each component are described below.

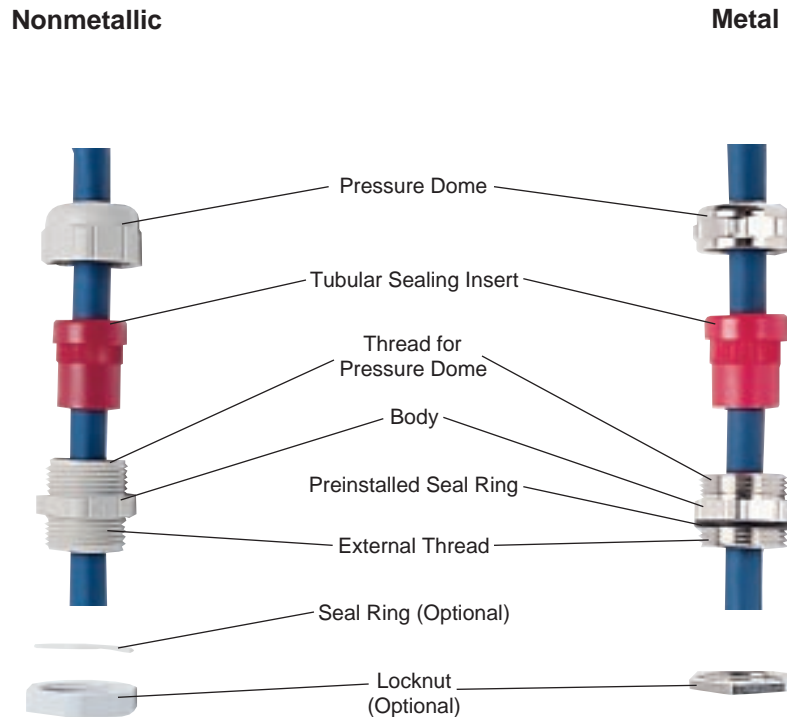

## Pressure Dome

The conical interior of the Pressure Dome transfers pressure to the Tubular Sealing Insert when the Dome is tightened.

## Tubular Sealing Insert

The Sealing Insert is extended in length to provide a Protection Rating of IP68 (NEMA 1, 2, 3, 3R, 4, 4X, 5, 6, 12, 13), up to 10 Bar (140 psi). The knurled outer surface of the Insert interlocks with the knurled inner surface of the Cord Grip to prevent the twisting of cable, cord, etc. when the Pressure Dome is tightened.

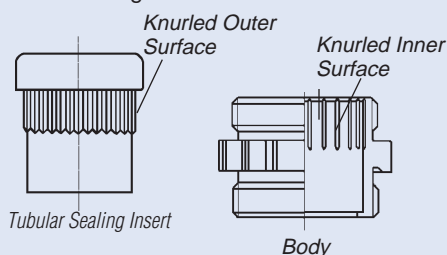

The Membrane at the lower end of the Insert has a reduced diameter. By simply pushing the cable/cord through, IP54 (NEMA 1, 2, 5, 12, 13) protection is provided without tightening the Pressure Dome.



PVC Polyvinylchloride (PV) Tubular Sealing Inserts are color-coded by cable diameter for easy identification.



## External Seal

Provides a hermetic seal between the Cord Grip and the enclosure wall. Seal Rings are not preinstalled on

nonmetallic Cord Grips. Please order separately if required, page 52.

Metal Cord Grips have preinstalled Perbunan (PR) or Silicone (SI) Seal Rings. Please refer to the ordering pages or to page 52.

## External Thread

High Performance Cord Grips are offered with external PG or NPT threads. For metric and extended length threads, please contact Altech.

## Locknuts

Use Locknuts for installation of Cord Grips into nonthreaded holes. Order Locknuts separately. Please refer to ordering pages or to page 54 for technical and ordering information.

## Straight-Through pages 28 - 35

Provide a liquid-tight seal and reliable strain relief for demanding applications.

### Sealing Function

When the Pressure Dome is tightened, its conical interior surface applies pressure to the Tubular Sealing Insert. This pressure causes the Tubular Insert to move toward the center of the Cord Grip to securely grip the cable over a wide surface area. As this occurs, the Tubular Insert will bulge along the cable and slightly out of the top of the Pressure Dome to seal the entire Cord Grip.

The Membrane at the lower end of the Insert has a reduced diameter. By simply pushing the cable/cord through, IP54 (NEMA 1, 2, 5, 12, 13 ) protection is provided without tightening the Pressure Dome.

**Installation**  
Please refer to page 5 to install Cord Grips.

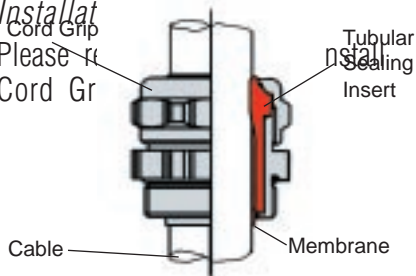

## Increased Strain Relief pages 36 and 37

For applications requiring increased strain relief.

Increased pull-out protection is achieved by using a Polyamide (PA) "Grip" Ring, which is integrated into the PVC Tubular Sealing Insert.



### Sealing Function

Cord Grips with Increased Pull-Out Protection use the same sealing function as the Straight-Through Cord Grips.

### Installation

Please refer to page 5 to install Cord Grips.

## Bend Protection pages 38 and 39

Prevents sharp bending plus provides strain relief, extending cable life.

An Extended Tubular Sealing Insert/Sleeve provides strain relief and Bend Protection in one. It increases the bending preventing sharp bend punctual stress. The cable sleeve can be easily changed to different cable/cord diameters.



### Sealing Function

Cord Grips with Bend Protection use the same sealing function as the Straight-Through Cord Grips.

### Installation

Please refer to page 5 to install Cord Grips.

### Key

- PV = PVC Polyvinylchloride
- ST = Santoprene
- TP = TPE Polyolefin
- SI = Silicone
- PP = Polyamide (PA) "Grip" Ring molded into PVC Polyvinylchloride (PV) Sleeve

	Function										
	Straight - Through					Increased Strain Relief			Bend Protection		
Body Material	Polyamide (PA)	PVDF Polyvinylidene (PO)	Brass, Nickel Plated (BN)	Stainless Steel (SS)	Polyamide (PA)	PVDF Polyvinylidene (PO)	Brass, Nickel Plated (BN)	Polyamide (PA)	PVDF Polyvinylidene (PO)	Brass, Nickel Plated (BN)	
Standard Color	Beige, Black	Opaque, Black	—	—	Beige, Black	Opaque, Black	—	Beige, Black	Opaque, Black	—	
Sealing Insert / Sleeve	PV, ST	PV,ST,TP,SI	PV,ST,TP,SI	PV,ST,TP,SI	PP	PP	PP	PV	PV	PV	
Seal Ring Preinstalled	No	No	Yes	Yes	No	No	Yes	No	No	Yes	
Size	PG NPT	PG9 - PG48 —	PG7 - PG48 NPT3/8-3/4	PG7 - PG42 —	PG9 - PG42 —	PG7 - PG42 —	PG7 - PG42 —	PG9 - PG36 —	PG9 - PG36 —	PG9 - PG36 —	
Cable Diameter (mm)	5.0 - 44.0	4.0 - 44.0	4.0 - 44.0	4.0 - 40.0	4.0 - 40.0	4.0 - 40.0	4.0 - 40.0	5.0 - 28.0	5.0 - 28.0	5.0 - 28.0	
Cable Diameter (in.)	(.20 - 1.73)	(.16 - 1.73)	(.16 - 1.73)	(.16 - 1.57)	(.16 - 1.57)	(.16 - 1.57)	(.16 - 1.57)	(.20 - 1.10)	(.20 - 1.10)	(.20 - 1.10)	

## Pull / Bend Protection pages 40 and 41

Provide Bend Protection and increased strain relief.

The Extended Tubular Insert/Sleeve has a molded in "Grip" Ring that provides increased Pull-Out protection. The sleeve determines the bend radius, preventing sharp bending of the cable/cord. The conical tip of the sleeve can be easily cut to fit different cable/cord diameters.

### Sealing Function

Cord Grips with Pull / Bend protection use the same sealing function as the Straight-Through Cord Grips.

### Installation

Please refer to page 5 to install Cord Grips.

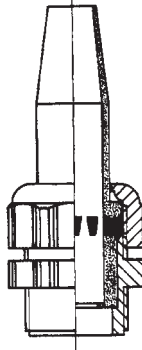

## Multi-Conductor pages 42 - 45

Saves cost, space and installation time. Multi-Conductor Cord Grips provide strain relief for multiple cables, cords and/or conductors of the same or varying diameters through a single Cord Grip.

Altech Multi-Conductor Cord Grip bodies are sold without Sealing Inserts and are constructed of Polyamide (PA) and Brass, Nickel Plated (BN). See page 42 for details.

We offer three types of PVC Polyvinylchloride (PV) Sealing Inserts; A.) Solid Core for shop drilling to meet various cable diameter combination(s), B.) A wide variety of premolded patterns and C.) Custom molding patterns. Please consult Altech with your custom or high volume requirements.



Sealing Plugs are available to seal unused holes, ensuring strain relief and IP65 (NEMA 1, 2, 3, 3R, 5, 12, 13) protection rating. Please refer to page 52 for Sealing Plug selection.

For your convenience, a handy Worksheet with Solid Core Sealing Insert Templates is provided on page 46.

### Installation

Please refer to page 5 to install Cord Grips.

## Flat Cable pages 48 and 49

Typically used with festooning and other flat cables. Rounded Sides and Oval Openings help to provide a better seal and maintain a Protection Rating of IP65 (NEMA 1, 2, 3, 3R, 5, 12, 13).

High Performance Flat Cable Cord Grips are supplied with a PVC Polyvinylchloride (PV) Tubular Sealing Insert.



Rounded Sides



Oval Openings

### Installation

Please refer to page 5 to install Cord Grips.

### Key

PV = PVC Polyvinylchloride  
PP = Polyamide (PA) "Grip" Ring molded into PVC Polyvinylchloride (PV) Sleeve

### Function

	Function					
	Pull/Bend Protection		Multi-Conductor		Flat Cable	
Body Material	Polyamide (PA)	Brass, Nickel Plated (BN)	Polyamide (PA)	Brass, Nickel Plated (BN)	Polyamide (PA)	Brass, Nickel Plated (BN)
Standard Color	Beige, Black	—	Beige, Black	—	Beige, Black	—
Sealing Insert / Sleeve	PP	PP	PV	PV	PV	PV
Seal Ring Preinstalled	No	Yes	No	Yes	No	Yes
Size	PG	PG9 - PG29	PG9 - PG36	PG9 - PG36	PG9 - PG48	PG9 - PG48
	NPT	—	—	—	—	—
Cable Diameter (mm)	4.0 - 25.0	4.0 - 25.0	1 - 21	1 - 21	3.5x5.5-9.0x43.0	3.5x5.5-9.0x43.0
Cable Diameter (in.)	(.16-.98)	(.16-.98)	(.04-.83)	(.04-.83)	(.14x.22-.35x1.69)	(.14x.22-.35x1.69)

**EMI / RFI page 47**

Provide sealing and strain relief plus shielding against electromagnetic and radio frequency interference.

Electromagnetic and radio frequency interference can cause costly interruptions of industrial machinery, etc. Therefore, associated control systems must be protected.

The most common way to provide EMI / RFI protection is to install electronics, controls, etc. into a shielded enclosure. However, the protective function of the enclosure shield can be greatly reduced if the

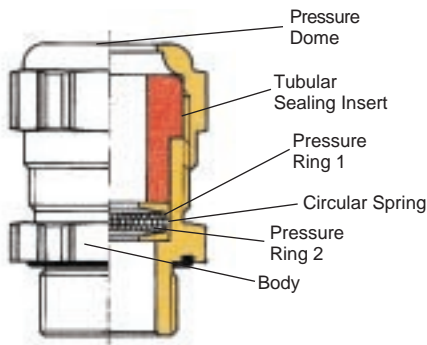

cable entries are not protected as well.

Altech's new generation of EMI / RFI Liquid Tight Strain Reliefs help prevent unwanted interference from entering and exiting the shielded enclosure. They become an integral part of the overall shield. The shielding function is obtained by producing a continuous ground connection between the cable shield and the enclosure itself.

**Shielding Function**

When the Pressure Dome is tightened, a Circular Spring is forced against the cable shield by two tapered Pressure Rings. At the same time, the Pressure Rings are grounded to the Strain Relief Body, which in turn is connected to the enclosure and its shield.

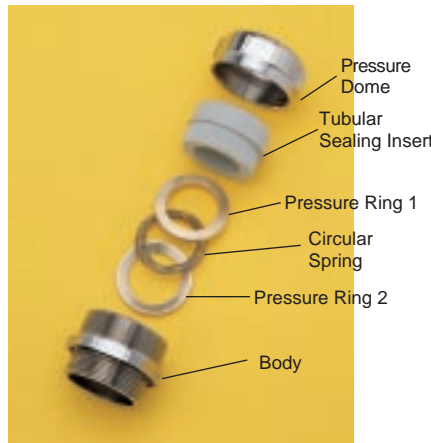

**Sealing Function**

EMI / RFI Cord Grips provide the same sealing function as the Straight-Through Cord Grips.

**Installation**

*Installation into nonthreaded holes*

To ensure a good ground connection between the Cord Grip and a **Metal Enclosure**, we strongly recommend the use of EMI / RFI Locknuts for nonthreaded mounting. The Locknut has six cutting edges, which will cut through paint and coatings into the metal of the enclosure.



EMI / RFI Locknut  
Side View

If **Nonmetallic Enclosures**

used, we suggest to connect the cable shield to a reliable ground potential within the enclosure and use a regular Locknut for the installation.

*Installation into threaded holes*

If a **Metal Enclosure** is used, be sure that the threads are free and clean of grease, lubricants, dust and other foreign materials, so that positive ground contact is ensured.

If the installation is into a **Nonmetallic Enclosure**, we must be taken to ensure continuity of the ground connection between the cable shield and the enclosure shield.

*Installation*

1. Install the Cord Grip body into the enclosure. Refer to page 5.
2. Remove Pressure Dome, Tubular Sealing Insert, Pressure Ring 1, Circular Spring and Pressure Ring 2.
3. Strip outer sheath from shielded cable. Make sure that sufficient wire length is available for connection.
4. Install the Pressure Dome and the Sealing Insert onto the cable sheath. Refer to photograph over the center column.
5. Install Pressure Ring 1 onto the exposed shield, with the tapered side facing the enclosure, and push against Cable Sheath.
6. Install the Circular Spring onto the shield.
7. Install Pressure Ring 2 onto the cable shield with the tapered side facing the Circular Spring.
8. Insert the cable with the installed parts into the Cord Grip Body. Make sure the outer cable sheath is firmly inserted into the Tubular Sealing Insert to obtain the specified IP/NEMA Rating.
9. Push the Tubular Sealing Insert with the installed cable into the Cord Grip Body.
10. Tighten down the Pressure Dome.

		Function	
		EMI/RFI	
		Body Material	
		Brass, Nickel Plated (ENI)	
Standard Color		—	
Sealing Ring / Sleeve		ST	
Seal Ring Preinstalled		Yes	
Size	PG	PG9 - PG42	
	NPT	—	
Cable Diameter	mm	4.0 - 41.0	
	(in.)	(.16 - 1.61)	

**Key**  
ST = Santoprene

## Temperature Range of Materials Used For High Performance Cord Grips

### Body Materials

Polyamide (PA)  
-20 to 100°C (-4 to 212°F)

PVDF Polyvinylidene (PO)  
-40 to 150°C (-40 to 302°F)

Brass, Nickel Plated (BN)  
-40 to 300°C (-40 to 572°F)

Stainless Steel (SS)  
-60 to 500°C (-65 to 932°F)

### Tubular Sealing Insert Materials

PVC Polyvinylchloride (PV)  
-20 to 80°C (-4 to 176°F)

Santoprene (ST)  
-60 to 125°C (-65 to 257°F)

TPE Polyolefin (TP)  
-40 to 120°C (-40 to 248°F)

Silicone (SI)  
-60 to 200°C (-65 to 392°F)

PVC Polyvinylchloride/Polyamide (PP)  
-20 to 80°C (-4 to 176°F)

### Seal Ring Materials

Polyethylene (PE)  
-20 to 100°C (-4 to 212°F)

Centellen (CT)  
-60 to 300°C (-65 to 572°F)

Perbunan (PR)  
-20 to 120°C (-4 to 248°F)

Silicone (SI)  
-60 to 200°C (-65 to 392°F)

## Accessories

For best results, Altech offers a full line of Accessories. For more specific information, please refer to the pages indicated.



**Seal Rings** *page 52*



**Socket Wrenches** *page 53*



**Sealing Plugs** *page 52*



**Locknuts** *page 54*



# HIGH PERFORMANCE STRAIGHT-THROUGH

## Polyamide (PA)

- IP68 (NEMA 1, 2, 3, 3R, 4, 4X, 5, 6, 12, 13) / 10 Bar (140 psi).
- PG standard.
- PVC Polyvinylchloride (PV) Tubular Sealing Inserts are color coded.
- Order Seal Rings and Locknuts separately if required.
- Standard color: Beige or Black.



## Polyamide (PA) with PVC Polyvinylchloride (PV) Tubular Sealing Insert

### Liquid Tight Strain Reliefs (Cord Grips)

<b>Body Material</b>	Polyamide (PA)
<b>Body Temperature</b>	-20 to 100°C (-4 to 212°F)
<b>Sealing Insert Material</b>	PVC Polyvinylchloride (PV)
<b>Sealing Insert Temperature Range</b>	-20 to 80°C (-4 to 176°F)
<b>Sealing Insert Color</b>	Multi

Type	Std. Pk.	Cable Dia. mm	Cable Dia. (in.)	Mtg. Hole Dia. <sup>1</sup> mm	Mtg. Hole Dia. <sup>1</sup> (in.)	Nearest Drill Size	Cat. No.		Sealing Insert Color
							Beige	Black	
PG9-PSPA - [ ][ ] [ ][ ] 08	50	5.0 - 8.0	(.20- .31)	15.5	(.61)	39/64	<b>70.001</b>	<b>70.031</b>	Gray
PG9-PSPA - [ ][ ] [ ][ ] 09	50	6.5 - 9.5	(.26- .37)	15.5	(.61)	39/64	<b>70.002</b>	<b>70.032</b>	Black
PG11-PSPA - [ ][ ] [ ][ ] 08	50	5.0 - 8.0	(.20- .31)	19.0	(.75)	3/4	<b>70.003</b>	<b>70.033</b>	Gray
PG11-PSPA - [ ][ ] [ ][ ] 09	50	6.5 - 9.5	(.26- .37)	19.0	(.75)	3/4	<b>70.004</b>	<b>70.034</b>	Black
PG11-PSPA - [ ][ ] [ ][ ] 10	50	7.0 - 10.5	(.28- .41)	19.0	(.75)	3/4	<b>70.005</b>	<b>70.035</b>	Green
PG13.5-PSPA - [ ][ ] [ ][ ] 09	50	6.5 - 9.5	(.26- .37)	21.0	(.83)	53/64	<b>70.006</b>	<b>70.036</b>	Black
PG13.5-PSPA - [ ][ ] [ ][ ] 10	50	7.0 - 10.5	(.28- .41)	21.0	(.83)	53/64	<b>70.007</b>	<b>70.037</b>	Green
PG13.5-PSPA - [ ][ ] [ ][ ] 13	50	9.0 - 13.0	(.35- .51)	21.0	(.83)	53/64	<b>70.008</b>	<b>70.038</b>	Red
PG16-PSPA - [ ][ ] [ ][ ] 10	25	7.0 - 10.5	(.28- .41)	23.0	(.91)	29/32	<b>70.009</b>	<b>70.039</b>	Green
PG16-PSPA - [ ][ ] [ ][ ] 13	25	9.0 - 13.0	(.35- .51)	23.0	(.91)	29/32	<b>70.010</b>	<b>70.040</b>	Red
PG16-PSPA - [ ][ ] [ ][ ] 15	25	11.5 - 15.5	(.45- .61)	23.0	(.91)	29/32	<b>70.011</b>	<b>70.041</b>	White
PG21-PSPA - [ ][ ] [ ][ ] 15	25	11.5 - 15.5	(.45- .61)	29.0	(1.14)	1-9/64	<b>70.012</b>	<b>70.042</b>	White
PG21-PSPA - [ ][ ] [ ][ ] 18	25	14.0 - 18.0	(.55- .71)	29.0	(1.14)	1-9/64	<b>70.013</b>	<b>70.043</b>	Blue
PG21-PSPA - [ ][ ] [ ][ ] 20	25	17.0 - 20.5	(.67- .81)	29.0	(1.14)	1-9/64	<b>70.014</b>	<b>70.044</b>	Brown
PG29-PSPA - [ ][ ] [ ][ ] 25	20	20.0 - 25.0	(.79- .98)	37.5	(1.48)	1-31/64	<b>70.015</b>	<b>70.045</b>	Orange
PG29-PSPA - [ ][ ] [ ][ ] 28	20	24.0 - 28.0	(.94- 1.10)	37.5	(1.48)	1-31/64	<b>70.016</b>	<b>70.046</b>	Light Yellow
PG36-PSPA - [ ][ ] [ ][ ] 32	10	27.0 - 32.0	(1.06- 1.26)	47.5	(1.87)	1-7/8	<b>70.017</b>	<b>70.047</b>	Dark Gray
PG36-PSPA - [ ][ ] [ ][ ] 36	10	32.0 - 36.0	(1.26- 1.42)	47.5	(1.87)	1-7/8	<b>70.018</b>	<b>70.048</b>	Rose
PG42-PSPA - [ ][ ] [ ][ ] 40	5	36.0 - 40.0	(1.42- 1.57)	54.5	(2.15)	2-5/32	<b>70.019</b>	—	White
PG48-PSPA - [ ][ ] [ ][ ] 44	5	39.0 - 44.0	(1.54- 1.73)	60.0	(2.36)	2-3/8	<b>70.020</b>	—	White

Sealing Insert Material, Example: PVC Polyvinylchloride **PV** or Santoprene **ST**  
 Body Color, Example: Beige **BE** or Black **BK**

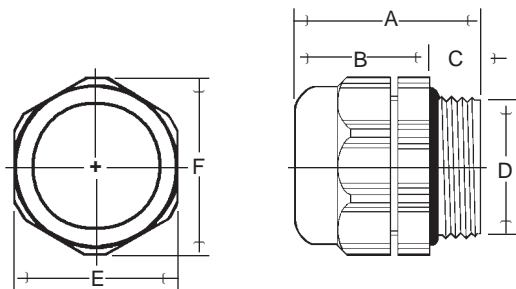

### Dimensions mm (in.)

Size	A	B	C	D	E	F
PG9	31.0 (1.22)	22.0 (.87)	9.0 (.35)	15.2 (.60)	19.0	16.2 (.64)
PG11	32.0 (1.26)	23.0 (.91)	9.0 (.35)	18.6 (.73)	22.0	21.0 (.83)
PG13.5	32.0 (1.26)	23.0 (.91)	9.0 (.35)	20.4 (.80)	24.0	24.5 (.96)
PG16	32.5 (1.28)	23.0 (.91)	9.5 (.37)	22.5 (.89)	27.0	26.5 (1.04)
PG21	38.0 (1.50)	27.0 (1.06)	11.0 (.43)	28.3 (1.11)	33.0	29.5 (1.16)
PG29	45.5 (1.79)	34.0 (1.34)	11.5 (.45)	37.0 (1.46)	43.0	36.5 (1.44)
PG36	48.0 (1.89)	34.0 (1.34)	14.0 (.55)	47.0 (1.85)	53.0	46.0 (1.81)
PG42	53.0 (2.09)	38.0 (1.50)	15.0 (.59)	54.0 (2.13)	60.0	57.0 (2.24)
PG48	53.0 (2.09)	38.0 (1.50)	15.0 (.59)	59.3 (2.33)	65.0	64.0 (2.52)
						70.0 (2.76)

<sup>1</sup> For installation into nonthreaded holes with Locknuts. Please refer to page 5 for installation instructions.

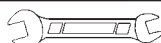

#### Installation

To install, we recommend the use of Socket (Refer to page 53), Metric Open-end or Adjustable Wrenches. Please refer to column "E" in the Dimensions Table for sizes.





## Polyamide (PA) with Santoprene (ST) Tubular Sealing Insert

Polyamide (PA)  
-20 to 100°C (-4 to 212°F)  
Santoprene (ST)  
-60 to 125°C (-65 to 257°F)  
Beige

Beige	Cat. No.	Black
—	—	—
70.060	—	70.080
—	—	—
—	—	—
70.061	—	70.081
70.062	—	70.082
70.063	—	70.083
70.064	—	70.084
70.065	—	70.085
70.066	—	70.086
70.067	—	70.087
70.068	—	70.088
70.069	—	70.089
70.070	—	70.090
—	—	—
70.072	—	70.092
—	—	—
70.073	—	70.093
—	—	—
—	—	—

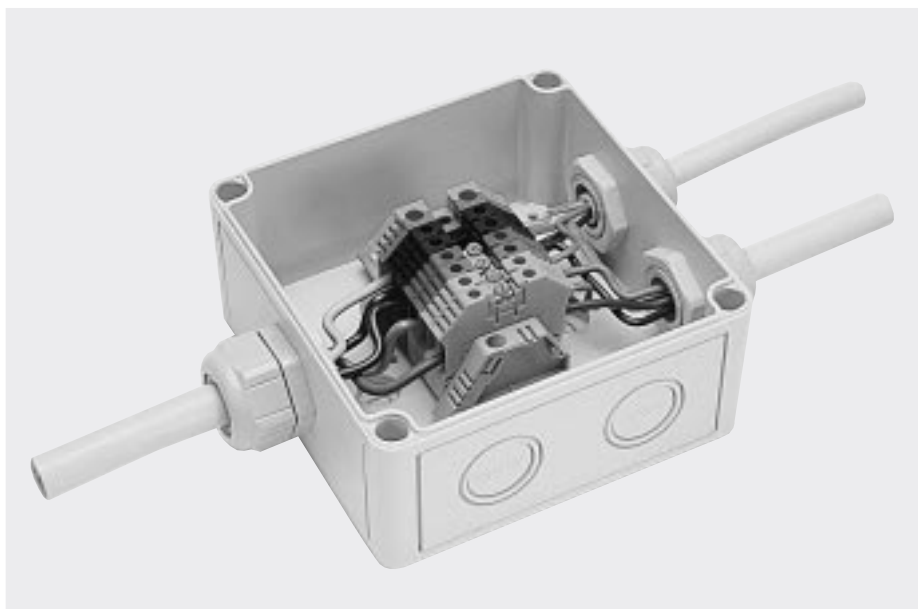

### Accessories

Material Temperature Range	Seal Rings (Additional information on page 52.)			Locknuts (Additional information on page 54.)				
	Polyethylene (PE)			Polyamide (PA)			Brass, Nickel Plated (BN)	
Size	-20 to 100°C (-4 to 212°F)			-20 to 100°C (-4 to 212°F)			-40 to 300°C (-40 to 572°F)	
	Cat. No. Opaque	Std. Pk.		Cat. No. Gray	Std. Pk.	Cat. No.	Std. Pk.	
PG9	86.601	100		86.001	86.022	100	86.501	100
PG11	86.602	100		86.002	86.023	100	86.502	50
PG13.5	86.603	100		86.003	86.024	100	86.503	50
PG16	86.604	50		86.004	86.025	50	86.504	50
PG21	86.605	50		86.005	86.026	50	86.505	50
PG29	86.606	20		86.006	86.027	25	86.506	25
PG36	86.607	10		86.007	86.028	10	86.507	10
PG42	86.608	5		86.008	86.029	5	86.508	5
PG48	86.609	5		86.009	86.030	5	86.509	5

# HIGH PERFORMANCE STRAIGHT-THROUGH PVDF Polyvinylidene (PO)

- IP68 (NEMA 1, 2, 3, 3R, 4, 4X, 5, 6, 12, 13) / 10 Bar (140 psi).
- PG, NPT standard.
- Long Thread 15mm (.59 in.) available.
- Order Seal Rings and Locknuts separately if required.
- Standard color: Opaque or Black. Blue available.

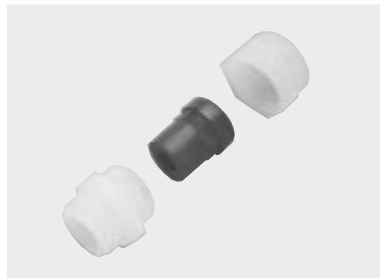

## PVDF Polyvinylidene (PO) with PVC Polyvinylchloride (PV) Tubular Sealing Insert

### Liquid Tight Strain Reliefs (Cord Grips)

#### Body Material

#### Body Temperature Range

#### Sealing Insert Material

#### Sealing Insert Temperature Range

#### Sealing Insert Color

#### PVDF Polyvinylidene (PO)

-40 to 150°C (-40 to 302°F)

#### PVC Polyvinylchloride (PV)

-20 to 80°C (-4 to 176°F)

Multi

Type	Std. Pk.	Cable Dia.		Mtg. Hole Dia. <sup>1</sup>	Nearest Drill Size	Cat. No.		Sealing Insert Color
		mm	(in.)			Opaque	Black	
PG7-PSPO- [ ] [ ] [ ] 06	50	4.0 - 6.5	(.16 - .26)	13.0 (.51)	33/64	<b>70.100</b>	<b>70.130</b>	Yellow
PG9-PSPO- [ ] [ ] [ ] 08	50	5.0 - 8.0	(.20 - .31)	15.5 (.61)	39/64	<b>70.101</b>	<b>70.131</b>	Gray
PG9-PSPO- [ ] [ ] [ ] 09	50	6.5 - 9.5	(.26 - .37)	15.5 (.61)	39/64	<b>70.102</b>	<b>70.132</b>	Black
PG11-PSPO- [ ] [ ] [ ] 08	50	5.0 - 8.0	(.20 - .31)	19.0 (.75)	3/4	<b>70.103</b>	<b>70.133</b>	Gray
PG11-PSPO- [ ] [ ] [ ] 09	50	6.5 - 9.5	(.26 - .37)	19.0 (.75)	3/4	<b>70.104</b>	<b>70.134</b>	Black
PG11-PSPO- [ ] [ ] [ ] 10	50	7.0 - 10.5	(.28 - .41)	19.0 (.75)	3/4	<b>70.105</b>	<b>70.135</b>	Green
PG13.5-PSPO- [ ] [ ] [ ] 09	50	6.5 - 9.5	(.26 - .37)	21.0 (.83)	53/64	<b>70.106</b>	<b>70.136</b>	Black
PG13.5-PSPO- [ ] [ ] [ ] 10	50	7.0 - 10.5	(.28 - .41)	21.0 (.83)	53/64	<b>70.107</b>	<b>70.137</b>	Green
PG13.5-PSPO- [ ] [ ] [ ] 13	50	9.0 - 13.0	(.35 - .51)	21.0 (.83)	53/64	<b>70.108</b>	<b>70.138</b>	Red
PG16-PSPO- [ ] [ ] [ ] 10	25	7.0 - 10.5	(.28 - .41)	23.0 (.91)	29/32	<b>70.109</b>	<b>70.139</b>	Green
PG16-PSPO- [ ] [ ] [ ] 13	25	9.0 - 13.0	(.35 - .51)	23.0 (.91)	29/32	<b>70.110</b>	<b>70.140</b>	Red
PG16-PSPO- [ ] [ ] [ ] 15	25	11.5 - 15.5	(.45 - .61)	23.0 (.91)	29/32	<b>70.111</b>	<b>70.141</b>	White
PG21-PSPO- [ ] [ ] [ ] 15	25	11.5 - 15.5	(.45 - .61)	29.0 (1.14)	1-9/64	<b>70.112</b>	<b>70.142</b>	White
PG21-PSPO- [ ] [ ] [ ] 18	25	14.0 - 18.0	(.55 - .71)	29.0 (1.14)	1-9/64	<b>70.113</b>	<b>70.143</b>	Blue
PG21-PSPO- [ ] [ ] [ ] 20	25	17.0 - 20.5	(.67 - .81)	29.0 (1.14)	1-9/64	<b>70.114</b>	<b>70.144</b>	Brown
PG29-PSPO- [ ] [ ] [ ] 25	20	20.0 - 25.0	(.79 - .98)	37.5 (1.48)	1-31/64	<b>70.115</b>	<b>70.145</b>	Orange
PG29-PSPO- [ ] [ ] [ ] 28	20	24.0 - 28.0	(.94 - 1.10)	37.5 (1.48)	1-31/64	<b>70.116</b>	<b>70.146</b>	Light Yellow
PG36-PSPO- [ ] [ ] [ ] 32	10	27.0 - 32.0	(1.06 - 1.26)	47.5 (1.87)	1-7/8	<b>70.117</b>	<b>70.147</b>	Dark Gray
PG36-PSPO- [ ] [ ] [ ] 36	10	32.0 - 36.0	(1.26 - 1.42)	47.5 (1.87)	1-7/8	<b>70.118</b>	<b>70.148</b>	Rose
PG42-PSPO- [ ] [ ] [ ] 40	5	36.0 - 40.0	(1.42 - 1.57)	54.5 (2.15)	2-5/32	<b>70.119</b>	—	White
PG48-PSPO- [ ] [ ] [ ] 44	5	39.0 - 44.0	(1.54 - 1.73)	60.0 (2.36)	2-3/8	<b>70.120</b>	—	White
NPT3/8-PSPO- [ ] [ ] [ ] 08	50	5.0 - 8.0	(.20 - .31)	17.5 (.69)	11/16	<b>70.121</b>	<b>70.151</b>	Gray
NPT1/2-PSPO- [ ] [ ] [ ] 10	50	7.0 - 10.5	(.28 - .41)	21.5 (.85)	27/32	<b>70.122</b>	<b>70.152</b>	Green
NPT3/4-PSPO- [ ] [ ] [ ] 15	25	11.5 - 15.5	(.45 - .61)	27.0 (1.06)	1-1/16	<b>70.123</b>	<b>70.153</b>	White

Sealing Insert Material, Example: PVC Polyvinylchloride **[PVC]** or Santoprene **[SFP]** or TPE Polyolefin **[TPE]** or Silicone **[SIL]**

Body Color, Example: Beige **[BE]** or Black **[BK]**

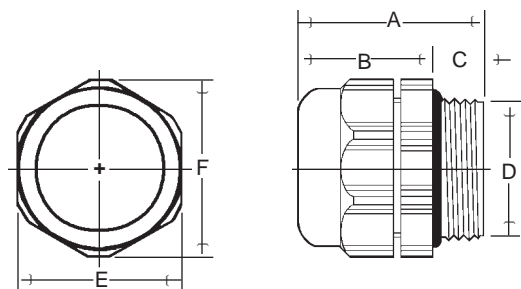

### Dimensions mm (in.)

Size	A	B	C	D	E	F
PG7	29.0 (.114)	21.0 (.83)	8.0 (.31)	12.5 (.49)	15.0	16.2 (.64)
PG9	31.0 (.122)	22.0 (.87)	9.0 (.35)	15.2 (.60)	19.0	21.0 (.83)
PG11	32.0 (.126)	23.0 (.91)	9.0 (.35)	18.6 (.73)	22.0	24.5 (.96)
PG13.5	32.0 (.126)	23.0 (.91)	9.0 (.35)	20.4 (.80)	24.0	26.5 (1.04)
PG16	32.5 (.128)	23.0 (.91)	9.5 (.37)	22.5 (.89)	27.0	29.5 (1.16)
PG21	38.0 (.150)	27.0 (1.06)	11.0 (.43)	28.3 (1.11)	33.0	36.5 (1.44)
PG29	45.5 (1.79)	34.0 (1.34)	11.5 (.45)	37.0 (1.46)	43.0	46.0 (1.81)
PG36	48.0 (1.89)	34.0 (1.34)	14.0 (.55)	47.0 (1.85)	53.0	57.0 (2.24)
PG42	53.0 (2.09)	38.0 (1.50)	15.0 (.59)	54.0 (2.13)	60.0	64.0 (2.52)
PG48	53.0 (2.09)	38.0 (1.50)	15.0 (.59)	59.3 (2.33)	65.0	70.0 (2.76)
NPT3/8"	41.5 (1.63)	28.5 (1.12)	13.0 (.51)	17.1 (.67)	22.0	24.4 (.96)
NPT1/2"	44.5 (1.75)	28.5 (1.12)	16.0 (.63)	21.2 (.83)	24.0	26.7 (1.05)
NPT3/4"	48.5 (1.91)	32.5 (1.28)	16.0 (.63)	26.6 (1.05)	33.0	36.5 (1.44)

<sup>1</sup> For installation into nonthreaded holes with Locknuts. Please refer to page 5 for installation instructions.



#### Installation

To install, we recommend the use of Socket (Refer to page 53), Metric Open-end or Adjustable Wrenches. Please refer to column "E" in the Dimensions Table for sizes.



**PVDF Polyvinylidene (PO)**  
with Santoprene (ST)  
Tubular Sealing Insert



**PVDF Polyvinylidene (PO)**  
with TPE Polyolefin (TP)  
Tubular Sealing Insert



**PVDF Polyvinylidene (PO)**  
with Silicone (SI)  
Tubular Sealing Insert

PVDF Polyvinylidene (PO)  
-40 to 150°C (-40 to 302°F)  
Santoprene (ST)  
-60 to 125°C (-65 to 257°F)  
Beige

PVDF Polyvinylidene (PO)  
-40 to 150°C (-40 to 302°F)  
TPE Polyolefin (TP)  
-40 to 120°C (-40 to 248°F)  
Beige

PVDF Polyvinylidene (PO)  
-40 to 150°C (-40 to 302°F)  
Silicone (SI)  
-60 to 200°C (-65 to 392°F)  
Opaque

	Cat. No.	
Opaque		Black
—	—	—
—	—	—
70.160		70.190
—	—	—
—	—	—
70.161		70.191
70.162		70.192
70.163		70.193
70.164		70.194
70.165		70.195
70.166		70.196
70.167		70.197
70.168		70.198
70.169		70.199
70.170		70.200
—	—	—
70.171		70.201
—	—	—
70.172		70.202
—	—	—
—	—	—

	Cat. No.	
Opaque		Black
70.210		70.230
—	—	—
70.211		70.231
—	—	—
70.212		70.232
70.213		70.233
70.214		70.234
70.215		70.235
70.216		70.236
70.217		70.237
70.218		70.238
70.219		70.239
—	—	—
70.220		70.240
70.221		70.241
70.222		70.242
70.223		70.243
—	—	—
—	—	—
—	—	—
—	—	—

	Cat. No.	
Opaque		Black
—	—	—
—	—	—
70.250		70.270
—	—	—
70.251		70.271
70.252		70.272
70.253		70.273
70.254		70.274
70.255		70.275
70.256		70.276
70.257		70.277
70.258		70.278
70.259		70.279
70.260		70.280
70.261		70.281
70.262		70.282
70.263		70.283
70.264		70.284
70.265		70.285
—	—	—
—	—	—

## Accessories

Material Temperature Range	Seal Rings (Additional information on page 52.)				Locknuts (Additional information on page 54.)				
	Polyethylene (PE) -20 to 100°C (-4 to 212°F)		Centellen (CT) -60 to 300°C (-65 to 572°F)		Polyamide (PA) -20 to 100°C (-4 to 212°F)			Brass, Nickel Plated (BN) -40 to 300°C (-40 to 572°F)	
	Cat. No. Opaque	Std. Pk.	Cat. No. Red	Std. Pk.	Cat. No. Gray	Std. Pk.	Cat. No. Black	Std. Pk.	Cat. No.
PG7	86.600	100	79.000	50	86.000	86.021	100	86.500	100
PG9	86.601	100	79.001	50	86.001	86.022	100	86.501	100
PG11	86.602	100	79.002	50	86.002	86.023	100	86.502	50
PG13.5	86.603	100	79.003	50	86.003	86.024	100	86.503	50
PG16	86.604	50	79.004	25	86.004	86.025	50	86.504	50
PG21	86.605	50	79.005	25	86.005	86.026	50	86.505	50
PG29	86.606	20	79.006	20	86.006	86.027	25	86.506	25
PG36	86.607	10	79.007	10	86.007	86.028	10	86.507	10
PG42	86.608	5	79.008	5	86.008	86.029	5	86.508	5
PG48	86.609	5	79.009	5	86.009	86.030	5	86.509	5
NPT3/8	86.602	100	79.002	50	86.061	86.081	50	86.541	50
NPT1/2	86.603	100	79.003	50	86.062	86.082	50	86.542	50
NPT3/4	86.605	50	79.005	25	86.063	86.083	25	86.543	25

# HIGH PERFORMANCE STRAIGHT-THROUGH

## Brass, Nickel Plated (BN)

- IP68 (NEMA 1, 2, 3, 3R, 4, 4X, 5, 6, 12, 13) / 10 Bar (140 psi).
- PG standard.
- Preinstalled Perbunan (PR) or Silicone (SI) Seal Ring.
- Long Thread 15mm (.59 in.) available.
- Order Locknuts separately if required.



## Brass, Nickel Plated (BN) with PVC Polyvinylchloride (PV) Tubular Sealing Insert

### Liquid Tight Strain Reliefs (Cord Grips)

Body Material	Brass, Nickel Plated (BN)
Body Temperature Range	-40 to 300° C (-40 to 572°F)
Sealing Insert Material	PVC Polyvinylchloride (PV)
Sealing Insert Temperature Range	-20 to 80°C (-4 to 176°F)
Sealing Insert Color	Multi
Seal Ring Material	Perbunan (PR)
Seal Ring Temperature Range	-20 to 120°C (-4 to 248°F)

Type	Std. Pk.	Cable Dia. mm	(in.)	Mtg. Hole Dia. <sup>1</sup> mm	(in.)	Nearest Drill Size	Cat. No.	Sealing Insert Color	
PG7-PSBN-	06	50	4.0 - 6.5	(.16 - .26)	13.0	(.51)	33/64	70.300	Yellow
PG9-PSBN-	08	50	5.0 - 8.0	(.20 - .31)	15.5	(.61)	39/64	70.301	Gray
PG9-PSBN-	09	50	6.5 - 9.5	(.26 - .37)	15.5	(.61)	39/64	70.302	Black
PG11-PSBN-	08	50	5.0 - 8.0	(.20 - .31)	19.0	(.75)	3/4	70.303	Gray
PG11-PSBN-	09	50	6.5 - 9.5	(.26 - .37)	19.0	(.75)	3/4	70.304	Black
PG11-PSBN-	10	50	7.0 - 10.5	(.28 - .41)	19.0	(.75)	3/4	70.305	Green
PG13.5-PSBN-	09	50	6.5 - 9.5	(.26 - .37)	21.0	(.83)	53/64	70.306	Black
PG13.5-PSBN-	10	50	7.0 - 10.5	(.28 - .41)	21.0	(.83)	53/64	70.307	Green
PG13.5-PSBN-	13	50	9.0 - 13.0	(.35 - .51)	21.0	(.83)	53/64	70.308	Red
PG16-PSBN-	10	25	7.0 - 10.5	(.28 - .41)	23.0	(.91)	29/32	70.309	Green
PG16-PSBN-	13	25	9.0 - 13.0	(.35 - .51)	23.0	(.91)	29/32	70.310	Red
PG16-PSBN-	15	25	11.5 - 15.5	(.45 - .61)	23.0	(.91)	29/32	70.311	White
PG21-PSBN-	15	25	11.5 - 15.5	(.45 - .61)	29.0	(1.14)	1-9/64	70.312	White
PG21-PSBN-	18	25	14.0 - 18.0	(.55 - .71)	29.0	(1.14)	1-9/64	70.313	Blue
PG21-PSBN-	20	25	17.0 - 20.5	(.67 - .81)	29.0	(1.14)	1-9/64	70.314	Brown
PG29-PSBN-	25	20	20.0 - 25.0	(.79 - .98)	37.5	(1.48)	1-31/64	70.315	Orange
PG29-PSBN-	28	20	24.0 - 28.0	(.94 - 1.10)	37.5	(1.48)	1-31/64	70.316	Light Yellow
PG36-PSBN-	32	10	27.0 - 32.0	(1.06 - 1.26)	47.5	(1.87)	1-7/8	70.317	Dark Gray
PG36-PSBN-	36	10	32.0 - 36.0	(1.26 - 1.42)	47.5	(1.87)	1-7/8	70.318	Rose
PG42-PSBN-	40	5	36.0 - 40.0	(1.42 - 1.57)	54.5	(2.15)	2-5/32	70.319	White
PG48-PSBN-	44	5	39.0 - 44.0	(1.54 - 1.73)	60.0	(2.36)	2-3/8	70.320	White

Sealing Insert Material. Example: PVC Polyvinylchloride **PM** or Santoprene **ST** or TPE Polyolefin **TP** or Silicone **SI**

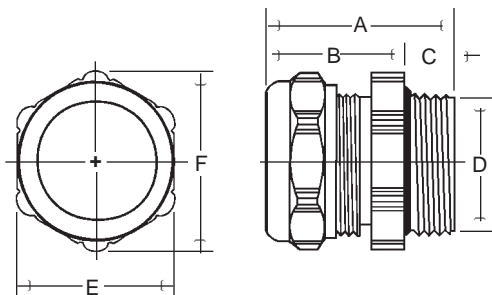

### Dimensions mm (in.)

Size	A	B	C	D	E	F
PG7	25.0 (.98)	20.0 (.79)	5.0 (.20)	12.5 (.49)	14.0	15.5 (.61)
PG9	26.0 (1.02)	20.0 (.79)	6.0 (.24)	15.2 (.60)	17.0	18.9 (.74)
PG11	26.0 (1.02)	20.0 (.79)	6.0 (.24)	18.6 (.73)	20.0	22.2 (.87)
PG13.5	27.5 (1.08)	21.0 (.83)	6.5 (.26)	20.4 (.80)	22.0	24.4 (.96)
PG16	27.5 (1.08)	21.0 (.83)	6.5 (.26)	22.5 (.89)	24.0	26.7 (1.05)
PG21	32.0 (1.26)	25.0 (.98)	7.0 (.28)	28.3 (1.11)	30.0	33.5 (1.32)
PG29	35.0 (1.38)	27.0 (1.06)	8.0 (.31)	37.0 (1.46)	40.0	43.5 (1.71)
PG36	37.0 (1.46)	28.0 (1.10)	9.0 (.35)	47.0 (1.85)	50.0	54.0 (2.24)
PG42	40.0 (1.57)	30.0 (1.18)	10.0 (.39)	54.0 (2.13)	57.0	61.0 (2.40)
PG48	40.0 (1.57)	30.0 (1.18)	10.0 (.39)	59.3 (2.33)	64.0	69.0 (2.72)

<sup>1</sup> For installation into nonthreaded holes with Locknuts. Please refer to page 5 for installation instructions.

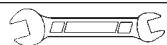

#### Installation

To install, we recommend the use of Socket (Refer to page 53), Metric Open-end or Adjustable Wrenches. Please refer to column "E" in the Dimensions Table for sizes.



**Brass, Nickel Plated (BN)  
with Santoprene (ST)  
Tubular Sealing Insert**



**Brass, Nickel Plated (BN)  
with TPE Polyolefin (TP)  
Tubular Sealing Insert**



**Brass, Nickel Plated (BN)  
with Silicone (SI)  
Tubular Sealing Insert**

Brass, Nickel Plated (BN)  
-40 to 300° C (-40 to 572°F)  
Santoprene (ST)  
-60 to 125°C (-65 to 257°F)  
Beige  
Perbunan (PR)  
-20 to 120°C (-4 to 248°F)

Cat. No.

—  
—  
70.330  
—  
—  
70.331  
70.332  
70.333  
70.334  
—  
70.335  
70.336  
70.337  
70.338  
70.339  
70.340  
—  
70.341  
—  
70.342  
—  
—

Brass, Nickel Plated (BN)  
-40 to 300° C (-40 to 572°F)  
TPE Polyolefin (TP)  
-40 to 120°C (-40 to 248°F)  
Beige  
Silicone (SI)  
-60 to 200°C (-65 to 392°F)

Cat. No.

70.350  
—  
70.351  
—  
—  
70.352  
70.353  
70.354  
70.355  
70.356  
—  
70.357  
70.358  
70.359  
—  
70.360  
70.361  
70.362  
70.363  
—  
—  
—  
—

Brass, Nickel Plated (BN)  
-40 to 300° C (-40 to 572°F)  
Silicone (SI)  
-60 to 200°C (-65 to 392°F)  
Opaque  
Silicone (SI)  
-60 to 200°C (-65 to 392°F)

Cat. No.

—  
—  
70.370  
—  
—  
70.371  
70.372  
70.373  
70.374  
70.375  
—  
70.376  
70.377  
70.378  
70.379  
70.380  
70.381  
70.382  
70.383  
—  
70.384  
—  
—

## Accessories

Locknuts (Additional information on page 54.)		
Material	Brass, Nickel Plated (BN)	
Temperature Range	-40 to 300°C (-40 to 572°F)	
Size	Cat. No.	Std. Pk.
PG7	86.500	100
PG9	86.501	100
PG11	86.502	50
PG13.5	86.503	50
PG16	86.504	50
PG21	86.505	50
PG29	86.506	25
PG36	86.507	10
PG42	86.508	5
PG48	86.509	5

# HIGH PERFORMANCE STRAIGHT-THROUGH

## Stainless Steel (SS)

- IP68 (NEMA 1, 2, 3, 3R, 4, 4X, 5, 6, 12, 13) / 10 Bar (140 psi).
- PG standard.
- Preinstalled Perbunan (PR) or Silicone (SI) Seal Ring.
- Order Locknuts separately if required.



## Stainless Steel (SS) with PVC Polyvinylchloride (PV) Tubular Sealing Insert

### Liquid Tight Strain Reliefs (Cord Grips)

<b>Body Material</b>	Stainless Steel (SS)
<b>Body Temperature Range</b>	-60 to 500°C (-65 to 932°F)
<b>Sealing Insert Material</b>	PVC Polyvinylchloride (PV)
<b>Sealing Insert Temperature Range</b>	-20 to 80°C (-4 to 176°F)
<b>Sealing Insert Color</b>	Multi
<b>Seal Ring Material</b>	Perbunan (PR)
<b>Seal Ring Temperature Range</b>	-20 to 120°C (-4 to 248°F)

Type	Std. Pk.	Cable Dia. mm	Cable Dia. (in.)	Mtg. Hole Dia. <sup>1</sup> mm	Mtg. Hole Dia. <sup>1</sup> (in.)	Nearest Drill Size	Cat. No.	Sealing Insert Color
PG7-PSSS- [ ] [ ] [ ] 06	10	4.0 - 6.5	(.16 - .26)	13.0 (.51)		33/64	<b>70.400</b>	Yellow
PG9-PSSS- [ ] [ ] [ ] 08	10	5.0 - 8.0	(.20 - .31)	15.5 (.61)		39/64	<b>70.401</b>	Gray
PG9-PSSS- [ ] [ ] [ ] 09	10	6.5 - 9.5	(.26 - .37)	15.5 (.61)		39/64	<b>70.402</b>	Black
PG11-PSSS- [ ] [ ] [ ] 08	10	5.0 - 8.0	(.20 - .31)	19.0 (.75)		3/4	<b>70.403</b>	Gray
PG11-PSSS- [ ] [ ] [ ] 10	10	7.0 - 10.5	(.28 - .41)	19.0 (.75)		3/4	<b>70.404</b>	Green
PG13.5-PSSS- [ ] [ ] [ ] 09	10	6.5 - 9.5	(.26 - .37)	21.0 (.83)		53/64	<b>70.405</b>	Black
PG13.5-PSSS- [ ] [ ] [ ] 10	10	7.0 - 10.5	(.28 - .41)	21.0 (.83)		53/64	<b>70.406</b>	Green
PG13.5-PSSS- [ ] [ ] [ ] 13	10	9.0 - 13.0	(.35 - .51)	21.0 (.83)		53/64	<b>70.407</b>	Red
PG16-PSSS- [ ] [ ] [ ] 10	5	7.0 - 10.5	(.28 - .41)	23.0 (.91)		29/32	<b>70.408</b>	Green
PG16-PSSS- [ ] [ ] [ ] 13	5	9.0 - 13.0	(.35 - .51)	23.0 (.91)		29/32	<b>70.409</b>	Red
PG16-PSSS- [ ] [ ] [ ] 15	5	11.5 - 15.5	(.45 - .61)	23.0 (.91)		29/32	<b>70.410</b>	White
PG21-PSSS- [ ] [ ] [ ] 13	5	9.0 - 13.0	(.35 - .51)	29.0(1.14)		1-9/64	<b>70.411</b>	Red
PG21-PSSS- [ ] [ ] [ ] 18	5	14.0 - 18.0	(.55 - .71)	29.0(1.14)		1-9/64	<b>70.412</b>	Blue
PG21-PSSS- [ ] [ ] [ ] 20	5	17.0 - 20.5	(.67 - .81)	29.0(1.14)		1-9/64	<b>70.413</b>	Brown
PG29-PSSS- [ ] [ ] [ ] 25	5	20.0 - 25.0	(.79 - .98)	37.5(1.48)		1-31/64	<b>70.414</b>	Orange
PG29-PSSS- [ ] [ ] [ ] 28	5	24.0 - 28.0	(.94 - 1.10)	37.5(1.48)		1-31/64	<b>70.415</b>	Light Yellow
PG36-PSSS- [ ] [ ] [ ] 32	2	27.0 - 32.0	(1.06 - 1.26)	47.5(1.87)		1-7/8	<b>70.416</b>	Dark Gray
PG36-PSSS- [ ] [ ] [ ] 36	2	32.0 - 36.0	(1.26 - 1.42)	47.5(1.87)		1-7/8	<b>70.417</b>	Rose
PG42-PSSS- [ ] [ ] [ ] 40	2	36.0 - 40.0	(1.42 - 1.57)	54.5(2.15)		2-5/32	<b>70.418</b>	White

Sealing Insert Material, Example: PVC Polyvinylchloride **PV** or Santoprene **ST** or TPE Polyolefin **TP** or Silicone **SI**

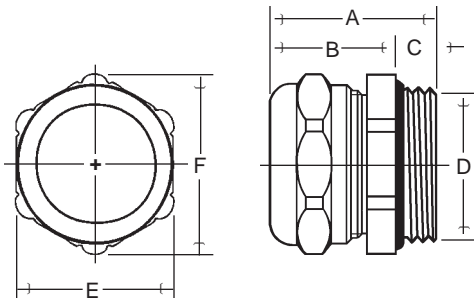

### Dimensions mm (in.)

Size	A	B	C	D	E	F
PG7	25.0 (.98)	20.0 (.79)	5.0 (.20)	12.5 (.49)	14.0	15.5 (.61)
PG9	26.0 (1.02)	20.0 (.79)	6.0 (.24)	15.2 (.60)	17.0	18.9 (.74)
PG11	26.0 (1.02)	20.0 (.79)	6.0 (.24)	18.6 (.73)	20.0	22.2 (.87)
PG13.5	27.5 (1.08)	21.0 (.83)	6.5 (.26)	20.4 (.80)	22.0	24.4 (.96)
PG16	27.5 (1.08)	21.0 (.83)	6.5 (.26)	22.5 (.89)	24.0	26.7 (1.05)
PG21	32.0 (1.26)	25.0 (.98)	7.0 (.28)	28.3 (1.11)	30.0	33.5 (1.32)
PG29	35.0 (1.38)	27.0 (1.06)	8.0 (.31)	37.0 (1.46)	40.0	43.5 (1.71)
PG36	37.0 (1.46)	28.0 (1.10)	9.0 (.35)	47.0 (1.85)	50.0	54.0 (2.24)
PG42	40.0 (1.57)	30.0 (1.18)	10.0 (.39)	54.0 (2.13)	57.0	61.0 (2.40)

<sup>1</sup> For installation into nonthreaded holes with Locknuts. Please refer to page 5 for installation instructions.

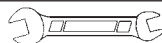

#### Installation

To install, we recommend the use of Socket (Refer to page 53), Metric Open-end or Adjustable Wrenches. Please refer to column "E" in the Dimensions Table for sizes.





**Stainless Steel (SS)  
with Santoprene (ST)  
Tubular Sealing Insert**

Stainless Steel (SS)  
-60 to 500°C (-65 to 932°F)  
Santoprene (ST)  
-60 to 125°C (-65 to 257°F)  
Beige  
Perbunan (PR)  
-20 to 120°C (-4 to 248°F)

Cat. No.

—  
—  
70.420  
—  
70.421  
70.422  
70.423  
70.424  
70.425  
70.426  
70.427  
—  
70.428  
70.429  
—  
70.430  
—  
70.431  
—



**Stainless Steel (SS)  
with TPE Polyolefin (TP)  
Tubular Sealing Insert**

Stainless Steel (SS)  
-60 to 500°C (-65 to 932°F)  
TPE Polyolefin (TP)  
-40 to 120°C (-40 to 248°F)  
Beige  
Silicone (SI)  
-60 to 200°C (-65 to 392°F)

Cat. No.

70.440  
—  
70.441  
—  
70.442  
70.443  
70.444  
70.445  
70.446  
70.447  
70.448  
—  
70.449  
70.450  
—  
70.451  
—  
—  
—



**Stainless Steel (SS)  
with Silicone (SI)  
Tubular Sealing Insert**

Stainless Steel (SS)  
-60 to 500°C (-65 to 932°F)  
Silicone (SI)  
-60 to 200°C (-65 to 392°F)  
Opaque  
Silicone (SI)  
-60 to 200°C (-65 to 392°F)

Cat. No.

—  
—  
70.460  
—  
70.461  
70.462  
70.463  
70.464  
70.465  
70.466  
70.467  
—  
70.468  
70.469  
70.470  
70.471  
—  
70.472  
—

## Accessories

### Material

### Temperature Range

### Locknuts (Additional information on page 54.)

### Stainless Steel (SS)

-60 to 500°C (-65 to 932°F)

### Size

### Cat. No.

### Std. Pk.

PG7  
PG9  
PG11  
PG13.5  
PG16  
PG21  
PG29  
PG36

86.520  
86.521  
86.522  
86.523  
86.524  
86.525  
86.526  
86.527

10  
10  
10  
10  
5  
5  
2  
2

# HIGH PERFORMANCE INCREASED STRAIN RELIEF PROTECTION

- IP54 (NEMA 1, 2, 5, 12, 13).
- PG standard.
- Brass, Nickel Plated (BN) Cord Grips feature preinstalled Perbunan (PR) Seal Rings. Order Seal Rings separately for Polyamide (PA) and PVDF Polyvinylidene (PO) Cord Grips (all sizes) if required.
- Order Locknuts separately if required.
- Standard color: Beige or Black Polyamide (PA), Opaque or Black PVDF Polyvinylidene (PO) or Brass, Nickel Plated (BN).



## Polyamide (PA) with PVC Polyvinylchloride / Polyamide (PP) Tubular Sealing Insert

### Liquid Tight Strain Reliefs (Cord Grips)

<b>Body Material</b>	Polyamide (PA)
<b>Body Temperature Range</b>	-20 to 100°C (-4 to 212°F)
<b>Sealing Insert Material</b>	PVC Polyvinylchloride/Polyamide (PP)
<b>Sealing Insert Temperature Range</b>	-20 to 80°C (-4 to 176°F)
<b>Sealing Insert Color</b>	Multi
<b>Seal Ring Material</b>	—
<b>Seal Ring Temperature Range</b>	—

Type	Std. Pk.	Insert Color	Mtg. Hole Dia. <sup>1</sup> mm (in.)	Nearest Drill Size	Cable Dia.		Cat No.	
					mm	(in.)	Beige	Black
PG7-PI  PP 06	50	Yellow	13.0 (.51)	33/64	4.0- 6.5	(.16- .26)	—	—
PG9-PI  PP 06	50	Yellow	15.5 (.61)	39/64	4.0- 6.5	(.16- .26)	<b>70.501</b>	<b>70.521</b>
PG9-PI  PP 09	50	Black	15.5 (.61)	39/64	5.5- 9.0	(.22 .35)	<b>70.502</b>	<b>70.522</b>
PG11-PI  PP 10	50	Gray	19.0 (.75)	3/4	6.0- 10.0	(.24- .39)	<b>70.503</b>	<b>70.523</b>
PG13.5-PI  PP 09	50	Black	21.0 (.83)	53/64	6.5- 9.5	(.26- .37)	<b>70.505</b>	<b>70.525</b>
PG13.5-PI  PP 10	50	Green	21.0 (.83)	53/64	6.0- 10.0	(.24- .39)	<b>70.506</b>	<b>70.526</b>
PG13.5-PI  PP 12	50	Red	21.0 (.83)	53/64	8.0- 12.0	(.31- .47)	<b>70.507</b>	<b>70.527</b>
PG16-PI  PP 10	25	Green	23.0 (.91)	29/32	6.0- 10.0	(.24- .39)	<b>70.508</b>	<b>70.528</b>
PG16-PI  PP 12	25	Red	23.0 (.91)	29/32	9.0- 12.0	(.35- .47)	<b>70.509</b>	<b>70.529</b>
PG16-PI  PP 15	25	White	23.0 (.91)	29/32	12.0- 15.0	(.47- .59)	<b>70.510</b>	<b>70.530</b>
PG21-PI  PP 15	25	White	29.0 (1.14)	1-9/64	12.0- 15.0	(.47- .59)	<b>70.511</b>	<b>70.531</b>
PG21-PI  PP 17	25	Blue	29.0 (1.14)	1-9/64	14.0- 17.0	(.55- .67)	<b>70.512</b>	<b>70.532</b>
PG21-PI  PP 20	25	Brown	29.0 (1.14)	1-9/64	16.0- 20.0	(.63- .79)	<b>70.513</b>	<b>70.533</b>
PG29-PI  PP 24	20	Orange	37.5 (1.48)	1-31/64	20.0- 24.0	(.79- .94)	<b>70.514</b>	<b>70.534</b>
PG29-PI  PP 27	20	Light Yellow	37.5 (1.48)	1-31/64	23.0- 27.0	(.91-1.06)	<b>70.515</b>	<b>70.535</b>
PG36-PI  PP 32	10	Dark Gray	47.5 (1.87)	1-7/8	27.0- 32.0	(1.06-1.26)	<b>70.516</b>	<b>70.536</b>
PG36-PI  PP 36	10	Rose	47.5 (1.87)	1-7/8	32.0- 36.0	(1.26-1.42)	<b>70.517</b>	<b>70.537</b>
PG42-PI  PP 40	5	White	54.5 (2.15)	2-5/32	34.0- 40.0	(1.34-1.57)	<b>70.518</b>	—

Body Color, Example: Beige [BE] or Black [BK] or Opaque [OP]  
 Body Material, Example: Polyamide [PA] or PVDF Polyvinylidene [PO] or Brass, Nickel Plated [BN]

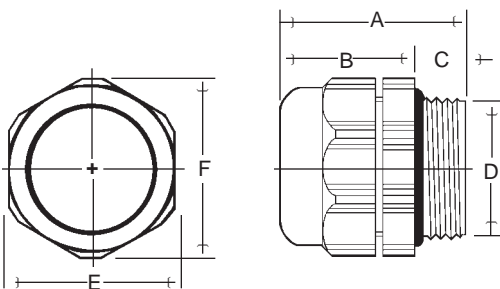

### Polyamide (PA) and PVDF Polyvinylidene (PO) Dimensions mm (in.)

Size	A	B	C	D	E	F
PG7	29.0 (1.14)	21.0 (.83)	8.0 (.31)	12.5 (.49)	15.0	16.2 (.64)
PG9	31.0 (1.22)	22.0 (.87)	9.0 (.35)	15.2 (.60)	19.0	21.0 (.83)
PG11	32.0 (1.26)	23.0 (.91)	9.0 (.35)	18.6 (.73)	22.0	24.5 (1.00)
PG13.5	32.0 (1.26)	23.0 (.91)	9.0 (.35)	20.4 (.80)	24.0	26.5 (1.04)
PG16	32.5 (1.28)	23.0 (.91)	9.5 (.37)	22.5 (.89)	27.0	29.5 (1.16)
PG21	38.0 (1.48)	27.0 (1.06)	11.0 (.43)	28.3 (1.11)	33.0	36.5 (1.44)
PG29	45.5 (1.79)	34.0 (1.34)	11.5 (.45)	37.0 (1.46)	43.0	46.0 (1.81)
PG36	48.0 (1.89)	34.0 (1.34)	14.0 (.55)	47.0 (1.85)	53.0	57.0 (2.24)
PG42	53.0 (2.09)	38.0 (1.48)	15.0 (.59)	54.0 (2.13)	60.0	64.0 (2.52)

<sup>1</sup> For installation into nonthreaded holes with Locknuts. Please refer to page 5 for installation instructions.



#### Installation

To install, we recommend the use of Socket (Refer to page 53), Metric Open-end or Adjustable Wrenches. Please refer to column "E" in the Dimensions Table for sizes.



**PVDF Polyvinylidene (PO)**  
with PVC Polyvinylchloride /  
Polyamide (PP) Tubular Sealing Insert



**Brass, Nickel Plated (BN)**  
with PVC Polyvinylchloride /  
Polyamide (PP) Tubular Sealing Insert

### Accessories

Seal Rings: please refer to page 52.  
Locknuts: please refer to page 54.

PVDF Polyvinylidene (PO)  
-40 to 150°C (-40 to 302°F)

PVC Polyvinylchloride/Polyamide (PP)  
-20 to 80°C (-4 to 176°F)

Multi

Brass, Nickel Plated (BN)  
-40 to 300°C (-40 to 572°F)

PVC Polyvinylchloride/Polyamide (PP)  
-20 to 80°C (-4 to 176°F)

Multi

Perbunan (PR)

-20 to 120°C (-4 to 248°F)

Cable Dia. mm	Cable Dia. (in.)	Cat No.	
		Opaque	Black
5.0- 6.5	(.20- .26)	<b>70.540</b>	<b>70.560</b>
5.0- 6.5	(.20- .26)	<b>70.541</b>	<b>70.561</b>
5.5- 9.5	(.22- .37)	<b>70.542</b>	<b>70.562</b>
7.5- 10.0	(.30- .39)	<b>70.543</b>	<b>70.563</b>
6.5- 9.5	(.26- .37)	<b>70.545</b>	<b>70.565</b>
7.0- 10.0	(.28- .39)	<b>70.546</b>	<b>70.566</b>
9.0- 12.0	(.35- .47)	<b>70.547</b>	<b>70.567</b>
7.0- 10.0	(.28- .39)	<b>70.548</b>	<b>70.568</b>
10.0- 12.0	(.39- .47)	<b>70.549</b>	<b>70.569</b>
12.0- 15.0	(.47- .59)	<b>70.550</b>	<b>70.570</b>
12.0- 15.0	(.47- .59)	<b>70.551</b>	<b>70.571</b>
14.0- 17.0	(.55- .67)	<b>70.552</b>	<b>70.572</b>
16.0- 20.0	(.63- .79)	<b>70.553</b>	<b>70.573</b>
20.0- 24.0	(.79- .94)	<b>70.554</b>	<b>70.574</b>
23.0- 27.0	(.91-1.06)	<b>70.555</b>	<b>70.575</b>
27.0- 32.0	(1.06-1.26)	<b>70.556</b>	<b>70.576</b>
32.0- 36.0	(1.26-1.42)	<b>70.557</b>	<b>70.577</b>
34.0- 40.0	(1.34-1.57)	<b>70.558</b>	—

Cable Dia. mm	Cable Dia. (in.)	Cat. No.
4.0- 6.5	(.16- .26)	<b>70.581</b>
5.5- 9.5	(.22- .37)	<b>70.582</b>
6.0- 10.0	(.24- .39)	<b>70.583</b>
6.5- 9.5	(.26- .37)	<b>70.585</b>
6.0- 10.0	(.24- .39)	<b>70.586</b>
8.0- 12.0	(.31- .47)	<b>70.587</b>
6.0- 10.0	(.24- .39)	<b>70.588</b>
9.0- 12.0	(.35- .47)	<b>70.589</b>
12.0- 15.0	(.47- .59)	<b>70.590</b>
12.0- 15.0	(.47- .59)	<b>70.591</b>
14.0- 17.0	(.55- .67)	<b>70.592</b>
16.0- 20.0	(.63- .79)	<b>70.593</b>
20.0- 24.0	(.79- .94)	<b>70.594</b>
23.0- 27.0	(.91-1.06)	<b>70.595</b>
27.0- 32.0	(1.06-1.26)	<b>70.596</b>
32.0- 36.0	(1.26-1.42)	<b>70.597</b>
34.0- 40.0	(1.34-1.57)	<b>70.598</b>

### Brass, Nickel Plated (BN) Dimensions mm (in.)

Size	A		B		C		D		E	F	
PG7	25.0	(.98)	20.0	(.79)	5.0	(.20)	15.2	(.60)	14.0	15.5	(.61)
	26.0	(1.02)	20.0	(.79)	6.0	(.24)	15.2	(.60)	17.0	18.9	(.74)
PG11	26.0	(1.02)	20.0	(.79)	6.0	(.24)	18.6	(.73)	20.0	22.2	(.87)
PG13.5	27.5	(1.08)	21.0	(.83)	6.5	(.26)	20.4	(.80)	22.0	24.4	(.96)
PG16	27.5	(1.08)	21.0	(.83)	6.5	(.26)	22.5	(.89)	24.0	26.7	(1.05)
PG21	32.0	(1.26)	25.0	(.98)	7.0	(.28)	28.3	(1.11)	30.0	33.5	(1.32)
PG29	35.0	(1.38)	27.0	(1.06)	8.0	(.31)	37.0	(1.46)	40.0	43.5	(1.71)
PG36	37.0	(1.46)	28.0	(1.10)	9.0	(.35)	47.0	(1.85)	50.0	54.0	(2.24)
PG42	40.0	(1.57)	30.0	(1.18)	10.0	(.39)	54.0	(2.13)	57.0	61.0	(2.40)

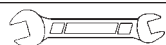
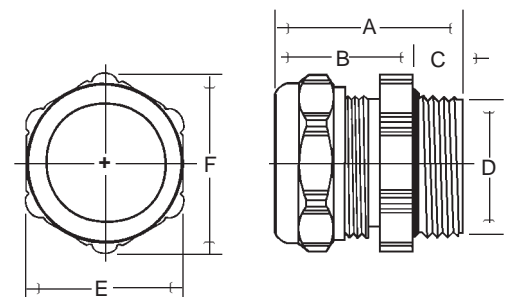

#### Installation

To install, we recommend the use of Socket (Refer to page 53), Metric Open-end or Adjustable Wrenches.  
Please refer to column "E" in the Dimensions Table for sizes.

# HIGH PERFORMANCE BEND PROTECTION

- IP68 (NEMA 1, 2, 3, 3R, 4, 4X, 5, 6, 12, 13) / 10 Bar (140 psi).
- PG standard.
- Brass, Nickel Plated (BN) Cord Grips feature preinstalled Perbunan (PR) Seal Rings. Order Seal Rings separately for Polyamide (PA) and PVDF Polyvinylidene (PO) Cord Grips if required.
- Order Locknuts separately if required.
- Standard color: Beige or Black Polyamide (PA), Opaque or Black PVDF Polyvinylidene (PO) or Brass, Nickel Plated (BN).



## Polyamide (PA) with PVC Polyvinylchloride (PV) Sealing Insert/Sleeve

Liquid Tight Strain Reliefs (Cord Grips)							
Body Material				Polyamide (PA)			
Body Temperature Range				-20 to 100°C (-4 to 212°F)			
Sealing Insert/Sleeve Material				PVC Polyvinylchloride (PV)			
Sealing Insert/Sleeve Temperature Range				-20 to 80°C (-4 to 176°F)			
Sealing Insert/Sleeve Color				Black			
Seal Ring Material				_____			
Seal Ring Temperature Range				_____			
Type	Std. Pk.	Mtg. Hole Dia. <sup>1</sup> mm (in.)	Nearest Drill Size	Cable Dia.		Cat. No.	
				mm (in.)	mm (in.)	Beige	Black
PG9-PB	25	15.5 (.61)	39/64	5.0- 6.5 (.20- .26)		70.701	70.721
PG9-PB	25	15.5 (.61)	39/64	5.0- 7.5 (.20- .30)		70.702	70.722
PG11-PB	25	19.0 (.75)	3/4	5.0- 7.5 (.20- .30)		70.703	70.723
PG11-PB	25	19.0 (.75)	3/4	6.0- 8.5 (.24- .33)		70.704	70.724
PG11-PB	25	19.0 (.75)	3/4	6.5- 9.5 (.26- .37)		70.705	70.725
PG13.5-PB	25	21.0 (.83)	53/64	6.0- 8.5 (.24- .33)		70.706	70.726
PG13.5-PB	25	21.0 (.83)	53/64	8.0- 10.5 (.31- .41)		70.707	70.727
PG16-PB	10	23.0 (.91)	29/32	6.5- 9.5 (.26- .37)		70.709	70.729
PG16-PB	10	23.0 (.91)	29/32	8.0- 10.5 (.31- .41)		70.710	70.730
PG16-PB	10	23.0 (.91)	29/32	10.5- 13.0 (.41- .51)		70.711	70.731
PG21-PB	10	29.0 (1.14)	1-9/64	14.0- 17.0 (.55- .67)		70.712	70.732
PG21-PB	10	29.0 (1.14)	1-9/64	17.0- 20.5 (.67- .81)		70.713	70.733
PG29-PB	5	37.5 (1.48)	1-31/64	—		—	—
PG29-PB	5	37.5 (1.48)	1-31/64	21.0- 24.0 (.83- .94)		70.714	70.734
PG36-PB	5	47.5 (1.87)	1-7/8	24.0- 28.0 (.94-1.10)		70.715	70.735

Body Color, Example: Beige [BE] or Black [BK] or Opaque [OP]  
 Body Material, Example: Polyamide [PA] or PVDF Polyvinylidene [PO] or Brass, Nickel Plated [BN]

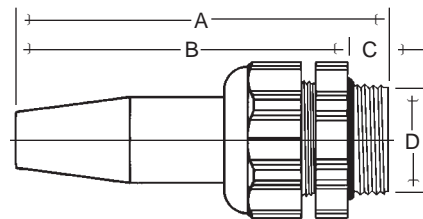
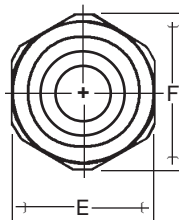

### Polyamide (PA) and PVDF Polyvinylidene (PO) Body Dimensions mm (in.)

Size	A	B	C	D	E	F
PG9	66.0 (2.60)	57.0 (2.24)	9.0 (.35)	15.2 (.60)	19.0	21.0 (.83)
PG11	73.0 (2.87)	64.0 (2.52)	9.0 (.35)	18.6 (.73)	22.0	24.5 (1.00)
PG13.5	81.0 (3.19)	72.0 (2.83)	9.0 (.35)	20.4 (.80)	24.0	26.5 (1.04)
PG16	81.0 (3.19)	71.5 (2.82)	9.5 (.37)	22.5 (.89)	27.0	29.5 (1.16)
PG21	90.0 (3.54)	79.0 (3.11)	11.0 (.43)	28.3 (1.11)	33.0	36.5 (1.44)
PG29	115.0 (4.53)	103.5 (4.07)	11.5 (.45)	37.0 (1.46)	43.0	46.0 (1.81)
PG36	124.0 (4.88)	110.0 (4.33)	14.0 (.55)	47.0 (1.85)	53.0	57.0 (2.24)

<sup>1</sup> For installation into nonthreaded holes with Locknuts. Please refer to page 5 for installation instructions.



#### Installation

To install, we recommend the use of Socket (Refer to page 53), Metric Open-end or Adjustable Wrenches. Please refer to column "E" in the Dimensions Table for sizes.



**PVDF Polyvinylidene (PO)**  
with PVC Polyvinylchloride (PV)  
Sealing Insert/Sleeve



**Brass, Nickel Plated (BN)**  
with PVC Polyvinylchloride (PV)  
Sealing Insert/Sleeve

PVDF Polyvinylidene (PO)  
-40 to 150°C (-40 to 302°F)  
PVC Polyvinylchloride (PV)  
-20 to 80°C (-4 to 176°F)  
Black

Brass, Nickel Plated (BN)  
-40 to 300°C (-40 to 572°F)  
PVC Polyvinylchloride (PV)  
-20 to 80°C (-4 to 176°F)  
Black  
Perbunan (PR)  
-20 to 120°C (-4 to 248°F)

**Accessories**

Seal Rings: please refer to page 52.  
Locknuts: please refer to page 54.

Cable Dia. mm	Cable Dia. (in.)	Cat. No	
		Opaque	Black
5.0- 6.5	(.20- .26)	<b>70.761</b>	<b>70.741</b>
5.0- 7.5	(.20- .30)	<b>70.762</b>	<b>70.742</b>
5.0- 7.5	(.20- .30)	<b>70.763</b>	<b>70.743</b>
6.0- 8.5	(.24- .33)	<b>70.764</b>	<b>70.744</b>
6.5- 9.5	(.26- .37)	<b>70.765</b>	<b>70.745</b>
6.0- 8.5	(.24- .33)	<b>70.766</b>	<b>70.746</b>
8.0-10.5	(.31- .41)	<b>70.767</b>	<b>70.747</b>
6.5- 9.5	(.26- .37)	<b>70.769</b>	<b>70.749</b>
8.0- 10.5	(.31- .41)	<b>70.770</b>	<b>70.750</b>
10.5- 13.0	(.41- .51)	<b>70.771</b>	<b>70.751</b>
14.0-17.0	(.55- .67)	<b>70.772</b>	<b>70.752</b>
17.0-20.5	(.67- .81)	<b>70.773</b>	<b>70.753</b>
17.0-20.5	(.66- .81)	<b>70.774</b>	<b>70.754</b>
21.0-24.0	(.83- .94)	<b>70.775</b>	<b>70.755</b>
24.0-28.0	(.94-1.10)	<b>70.776</b>	<b>70.756</b>

Cable Dia. mm	Cable Dia. (in.)	Cat. No.
4.0- 6.5	(.16- .26)	<b>70.781</b>
5.0- 7.5	(.20- .30)	<b>70.782</b>
—	—	—
5.0- 8.5	(.20- .33)	<b>70.783</b>
6.5- 9.5	(.26- .37)	<b>70.784</b>
5.0- 8.5	(.20- .33)	<b>70.785</b>
7.0- 10.5	(.28- .41)	<b>70.786</b>
6.0- 9.5	(.24- .37)	<b>70.788</b>
7.0- 10.5	(.28- .41)	<b>70.789</b>
9.0- 13.0	(.36- .51)	<b>70.790</b>
14.0- 17.5	(.55- .69)	<b>70.791</b>
16.0- 20.5	(.61- .81)	<b>70.792</b>
16.0- 20.5	(.63- .81)	<b>70.793</b>
20.0- 24.0	(.79- .94)	<b>70.794</b>
24.0- 28.0	(.94-1.10)	<b>70.795</b>

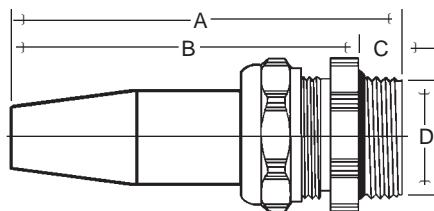
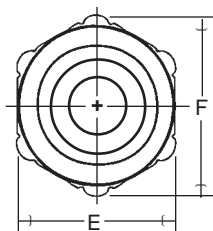

**Brass, Nickel Plated (BN) Body Dimensions mm (in.)**

Size	A	B	C	D	E	F
PG9	61.0 (2.40)	55.0 (2.17)	6.0 (.24)	15.2 (.60)	17.0	18.9 (.74)
PG11	66.0 (2.60)	60.0 (2.36)	6.0 (.24)	18.6 (.73)	20.0	22.2 (.87)
PG13.5	76.0 (2.99)	69.5 (2.74)	6.5 (.26)	20.4 (.80)	22.0	24.4 (.96)
PG16	76.0 (2.99)	69.5 (2.74)	6.5 (.26)	22.5 (.89)	24.0	26.7 (1.05)
PG21	83.0 (3.27)	76.0 (2.99)	7.0 (.28)	28.3 (1.11)	30.0	33.5 (1.32)
PG29	108.0 (4.25)	100.0 (3.94)	8.0 (.31)	37.0 (1.46)	40.0	43.5 (1.71)
PG36	114.0 (4.49)	106.0 (4.17)	9.0 (.35)	47.0 (1.85)	50.0	54.0 (2.13)

**Installation**  
To install, we recommend the use of Socket (Refer to page 53), Metric Open-end or Adjustable Wrenches.  
Please refer to column "E" in the Dimensions Table for sizes.



# HIGH PERFORMANCE PULL / BEND PROTECTION

- IP65 (NEMA 1, 2, 3, 3R, 5, 12, 13).
- PG standard.
- Brass, Nickel Plated (BN) Cord Grips feature preinstalled Perbunan (PR) Seal Rings. Order Seal Rings separately for Polyamide (PA) Cord Grips if required.
- Order Locknuts separately if required.
- Standard color: Beige or Black Polyamide (PA) or Brass, Nickel Plated (BN).



## Polyamide (PA) with PVC Polyvinylchloride / Polyamide (PP) Sealing Insert/Sleeve

### Liquid Tight Strain Reliefs (Cord Grips)

Body Material	Polyamide (PA)
Body Temperature Range	-20 to 100°C (-4 to 212°F)
Sealing Insert/Sleeve Material	PVC Polyvinylchloride/Polyamide (PP)
Sealing Insert/Sleeve Temperature Range	-20 to 80°C (-4 to 176°F)
Sealing Insert/Sleeve Color	Black
Seal Ring Material	—
Seal Ring Temperature Range	—

Type	Std. Pk.	Cable Dia. mm (in.)	Mtg. Hole Dia. <sup>1</sup> mm (in.)	Nearest Drill Size	Cat No.	
					Beige	Black
PG9-PP □□-□□ PV 06	25	4.0 - 6.5 (.16- .26)	15.5 (.61)	39/64	<b>71.001</b>	<b>71.021</b>
PG11-PP □□-□□ PV 09	25	6.5 - 9.5 (.26- .37)	19.0 (.75)	3/4	<b>71.003</b>	<b>71.023</b>
PG13.5-PP □□-□□ PV 09	25	6.5 - 9.5 (.26- .37)	21.0 (.83)	53/64	<b>71.005</b>	<b>71.025</b>
PG13.5-PP □□-□□ PV 10	25	8.5 - 10.5 (.33- .41)	21.0 (.83)	53/64	<b>71.006</b>	<b>71.026</b>
PG16-PP □□-□□ PV 09	10	6.5 - 9.5 (.26- .37)	23.0 (.91)	29/32	<b>71.008</b>	<b>71.028</b>
PG16-PP □□-□□ PV 10	10	7.0 - 10.5 (.28- .41)	23.0 (.91)	29/32	<b>71.009</b>	<b>71.029</b>
PG16-PP □□-□□ PV 13	10	9.5 - 13.0 (.37- .51)	23.0 (.91)	29/32	<b>71.010</b>	<b>71.030</b>
PG21-PP □□-□□ PV 13	10	9.0 - 13.0 (.35- .51)	29.0 (1.14)	1-9/64	<b>71.011</b>	<b>71.031</b>
PG21-PP □□-□□ PV 15	10	13.0 - 15.5 (.51- .61)	29.0 (1.14)	1-9/64	<b>71.012</b>	<b>71.032</b>
PG21-PP □□-□□ PV 18	10	14.0 - 18.0 (.55- .71)	29.0 (1.14)	1-9/64	<b>71.013</b>	<b>71.033</b>
PG29-PP □□-□□ PV 21	5	17.0 - 21.0 (.67- .83)	37.5 (1.48)	1-31/64	<b>71.014</b>	<b>71.034</b>
PG29-PP □□-□□ PV 25	5	21.0 - 25.0 (.83- .98)	37.5 (1.48)	1-31/64	<b>71.015</b>	<b>71.035</b>

□□ Body Color, Example: Beige [BIE] or Black [BK]  
 □□ Body Material, Example: Polyamide [PA] or Brass, Nickel Plated [BN]

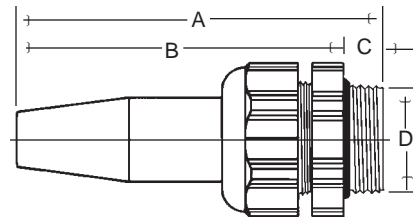
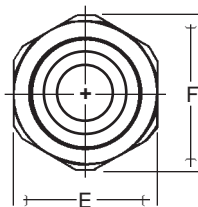

### Polyamide (PA) Dimensions mm (in.)

Size	A	B	C	D	E	F
PG9	66.0 (2.60)	57.0 (2.24)	9.0 (.35)	15.2 (.60)	19.0	21.0 (.83)
PG11	73.0 (2.87)	64.0 (2.52)	9.0 (.35)	18.6 (.73)	22.0	24.5 (1.00)
PG13.5	81.0 (3.19)	72.0 (2.83)	9.0 (.35)	20.4 (.80)	24.0	26.5 (1.04)
PG16	81.0 (3.19)	71.5 (2.82)	9.5 (.37)	22.5 (.89)	27.0	29.5 (1.16)
PG21	90.0 (3.54)	79.0 (3.11)	11.0 (.43)	28.3 (1.11)	33.0	36.5 (1.44)
PG29	115.0 (4.53)	103.5 (4.07)	11.5 (.45)	37.0 (1.46)	43.0	46.0 (1.81)

<sup>1</sup> For installation into nonthreaded holes with Locknuts. Please refer to page 5 for installation instructions.



#### Installation

To install, we recommend the use of Socket (Refer to page 53), Metric Open-end or Adjustable Wrenches. Please refer to column "E" in the Dimensions Table for sizes.



## Brass, Nickel Plated (BN) with PVC Polyvinylchloride / Polyamide (PP) Sealing Insert/Sleeve

**Brass, Nickel Plated (BN)**  
-40 to 300°C (-40 to 572°F)  
**PVC Polyvinylchloride/Polyamide (PP)**  
-20 to 80°C (-4 to 176°F)  
**Black**  
**Perbunan (PR)**  
-20 to 120°C (-4 to 248°F)

Cat. No.

— —

71.040

71.042

71.044

71.045

71.047

71.048

71.049

71.050

71.051

71.052

71.053

71.054

### Accessories

Material	Seal Rings (Additional information on page 52.) Polyethylene (PE)		Locknuts (Additional information on page 54.) Polyamide (PA)			Brass, Nickel Plated (BN)	
	Temperature Range	Cat. No. Opaque	Std. Pk.	Cat. No. Gray	Std. Pk.	Cat. No.	Std. Pk.
	-20 to 100°C (-4 to 212°F)						
PG9	86.601	100	86.001	86.022	100	86.501	100
PG11	86.602	100	86.002	86.023	100	86.502	50
PG13.5	86.603	100	86.003	86.024	100	86.503	50
PG16	86.604	50	86.004	86.025	50	86.504	50
PG21	86.605	50	86.005	86.026	50	86.505	50
PG29	86.606	20	86.006	86.027	25	86.506	25
PG36	86.607	10	86.007	86.028	10	86.507	10
PG42	86.608	5	86.008	86.029	5	86.508	5
PG48	86.609	5	86.009	86.030	5	86.509	5

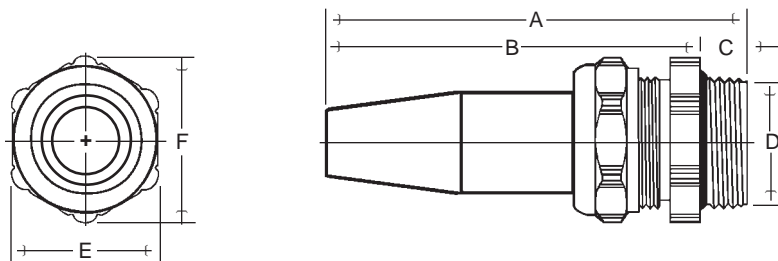

### Brass, Nickel Plated (BN) Body Dimensions mm (in.)

Size	A	B	C	D	E	F
PG9	61.0 (2.40)	55.0 (2.17)	6.0 (.24)	15.2 (.60)	17.0	18.9 (.74)
PG11	66.0 (2.60)	60.0 (2.36)	6.0 (.24)	18.6 (.73)	20.0	22.2 (.87)
PG13.5	76.0 (2.99)	69.5 (2.74)	6.5 (.26)	20.4 (.80)	22.0	24.4 (.96)
PG16	76.0 (2.99)	69.5 (2.74)	6.5 (.26)	22.5 (.89)	24.0	26.7 (1.05)
PG21	83.0 (3.27)	76.0 (2.99)	7.0 (.28)	28.3 (1.11)	30.0	33.5 (1.32)
PG29	108.0 (4.25)	100.0 (3.94)	8.0 (.31)	37.0 (1.46)	40.0	43.5 (1.71)



#### Installation

To install, we recommend the use of Socket (Refer to page 53), Metric Open-end or Adjustable Wrenches. Please refer to column "E" in the Dimensions Table for sizes.

# HIGH PERFORMANCE MULTI-CONDUCTOR BODIES

## Polyamide (PA) and Brass, Nickel Plated (BN)

High Performance Multi-Conductor Strain Reliefs are used to install several cables, cords, etc. of identical or different diameters through one Cord Grip into an enclosure.

Typically used when space is restricted or when multiple cables must be installed, Multi-Conductors seal and provide strain relief. They are available with Polyamide (PA) and Brass, Nickel Plated (BN) bodies. The Sealing Insert material is PVC Polyvinylchloride (PV) and is available in three different variations:

1. Premolded with a number of holes of the same or different diameters. Please refer to pages 43 to 45 for available patterns, keeping in mind that the hole size selected for specific cables should match the actual diameter closely. A tolerance of -1mm (0.04 in.) should not be exceeded to ensure proper sealing. If all of the holes are not required when using a Premolded Multi-Conductor Insert, refer to page 52 for the appropriate size Sealing Plug. Sealing Plugs should be inserted into unused holes to maintain the rated seal and strain relief rating.

2. Solid Inserts for self customization are available for sizes PG9 to PG36 bodies. Please refer to page 45 for more information on Solid Inserts and to page 46 for a shop drilling worksheet. Order inserts and Cord Grip bodies separately.

3. Custom drilled or Custom Molded Inserts can also be supplied. For low to medium quantities, Altech will gladly drill custom holes into the inserts for you. If higher volumes are required, special molding tools may help to keep the cost down. Please challenge us to help you solve your problem.

To select the proper insert, determine the number and diameters of cables/cords to be installed, then choose the matching body in the material and color you prefer and any accessories (page 52). Order bodies, inserts and accessories separately.

- IP65 (NEMA 1, 2, 3, 3R, 5, 12, 13).
- PG standard.
- Brass, Nickel Plated (BN) Cord Grips feature preinstalled Perbunan (PR) Seal Rings. Order Seal Rings separately for Polyamide (PA) Cord Grips if required. Please Refer to page 52.
- Standard color of body: Beige or Black Polyamide (PA) or Brass, Nickel Plated (BN).
- Insert color: White.
- Order Locknuts separately if required. Please refer to page 54.



Polyamide (PA)









Brass, Nickel Plated (BN)

### Body Technical and Ordering Information. Order Inserts Separately







Body Material	Polyamide (PA)	Brass, Nickel Plated (BN)
Body Temperature Range	-20 to 100°C (-4 to 212°F)	-40 to 300°C (-40 to 572°F)

#### Polyamide (PA)

Type	Std. Pk.	Cat. No.		Mtg. Hole Dia. mm (in.)	Nearest Drill Size
		Beige	Black		
PG9-PMPA- 	25	71.701	71.711	15.5 (.61)	39/64
PG11-PMPA- 	25	71.702	71.712	19.0 (.75)	3/4
PG13.5-PMPA- 	25	71.703	71.713	21.0 (.83)	53/64
PG16-PMPA- 	25	71.704	71.714	23.0 (.91)	29/32
PG21-PMPA- 	10	71.705	71.715	29.0 (1.14)	1-9/64
PG29-PMPA- 	5	71.706	71.716	37.5 (1.48)	1-31/64
PG36-PMPA- 	5	71.707	71.717	47.5 (1.87)	1-7/8

Body Color, Example: Beige **[B][E]** or Black **[B][K]**

#### Brass, Nickel Plated (BN)

Type	Std. Pk.	Cat. No.	Mtg. Hole Dia. mm (in.)	Nearest Drill Size
PG9-PMBN- 	25	71.731	15.5 (.61)	39/64
PG11-PMBN- 	25	71.732	19.0 (.75)	3/4
PG13.5-PMBN- 	25	71.733	21.0 (.83)	53/64
PG16-PMBN- 	25	71.734	23.0 (.91)	29/32
PG21-PMBN- 	10	71.735	29.0 (1.14)	1-9/64
PG29-PMBN- 	5	71.736	37.5 (1.48)	1-31/64
PG36-PMBN- 	5	71.737	47.5 (1.87)	1-7/8

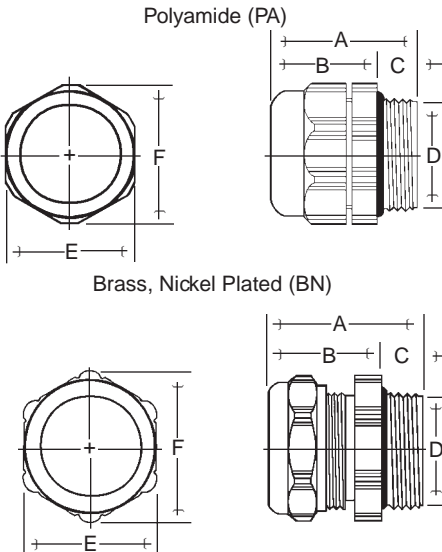

#### Dimensions mm (in.)

Size	A	B	C	D	E	F
<b>Polyamide (PA)</b>						
PG9	31.0 (1.22)	22.0 (.87)	9.0 (.35)	15.2 (.60)	19.0	21.0 (.83)
PG11	32.0 (1.26)	23.0 (.91)	9.0 (.35)	18.6 (.73)	22.0	24.5 (1.00)
PG13.5	33.0 (1.26)	23.0 (.91)	9.0 (.35)	20.4 (.80)	24.0	26.5 (1.04)
PG16	32.5 (1.28)	23.0 (.91)	9.5 (.37)	22.5 (.89)	27.0	29.5 (1.16)
PG21	38.0 (1.48)	27.0 (1.06)	11.0 (.43)	28.3 (1.11)	33.0	36.5 (1.44)
PG29	45.5 (1.79)	34.0 (1.34)	11.5 (.45)	37.0 (1.46)	43.0	46.0 (1.81)
PG36	48.0 (1.89)	34.0 (1.34)	14.0 (.55)	47.0 (1.85)	53.0	57.0 (2.24)
<b>Brass, Nickel Plated (BN)</b>						
PG9	26.0 (1.02)	20.0 (.79)	6.0 (.24)	15.2 (.60)	17.0	18.9 (.74)
PG11	26.0 (1.02)	20.0 (.79)	6.0 (.24)	18.6 (.73)	20.0	22.2 (.87)
PG13.5	27.5 (1.08)	21.0 (.83)	6.5 (.26)	20.4 (.80)	22.0	24.4 (.96)
PG16	27.5 (1.08)	21.0 (.83)	6.5 (.26)	22.5 (.89)	24.0	26.7 (1.05)
PG21	32.0 (1.26)	25.0 (.98)	7.0 (.28)	28.3 (1.11)	30.0	33.5 (1.32)
PG29	35.0 (1.38)	27.0 (1.06)	8.0 (.31)	37.0 (1.46)	40.0	43.5 (1.71)
PG36	37.0 (1.46)	28.0 (1.10)	9.0 (.35)	47.0 (1.85)	50.0	54.0 (2.24)

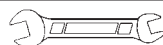

#### Installation

To install, we recommend the use of Socket (Refer to page 53), Metric Open-end or Adjustable Wrenches. Please refer to column "E" in the Dimensions Table for sizes.

## HIGH PERFORMANCE PVC POLYVINYLCHLORIDE(PV) MULTI-CONDUCTOR INSERTS

Insert Technical and Ordering Information. Order Bodies Separately.

Sealing Insert Material **PVC Polyvinylchloride (PV)**

Sealing Insert Temperature Range **-20 to 80°C  
(-4 to 176°F)**

## HIGH PERFORMANCE PVC POLYVINYLCHLORIDE(PV) PREMOLDED MULTI-CONDUCTOR INSERTS



A wide variety of Premolded Inserts are available from stock with holes of identical or different diameters. Inserts are shown on pages 43 to 45. They have been organized by PG sizes as well as number and diameter of holes. To select the proper Cord Grip assemblies for your application, first determine the number and diameter of cables to be inserted through the Multi-Conductor Strain Relief(s). Next, select a suitable Insert from page 43 to 45, then select the body that matches the PG size of the selected Insert from page 42. Choose the body from Polyamide (PA) or Brass, Nickel Plated (BN) types, depending on your preference and environmental conditions expected. Spare holes should be plugged with Sealing Plugs (page 52) to obtain the rated protection level. Order Inserts (page 43 to 45), bodies (page 42) and any accessories (page 52) separately. Use the worksheet on page 46 when holes must be drilled. Use the same worksheet to communicate to Altech the quantity, diameter(s) and location of any holes you want us to drill or to order Custom Molded Inserts (a tooling charge may be required).

Metric to Inch Measurement Conversion  
Millimeters ÷ (25.4) = Inches  
Inches x (25.4) = Millimeters

### PG9

#### Same Diameter

Size	Std. Pk.	Hole Qty.	x Dia.	Cat. No. White	Size	Std. Pk.	Hole Qty.	x Dia.	Cat. No. White
PG9	25	1	x 3.0mm	71.400-MI	PG9	25	2	x 3.0mm	71.404-MI
PG9	25	1	x 4.0mm	71.401-MI	PG9	25	3	x 3.0mm	71.405-MI
PG9	25	1	x 5.0mm	71.402-MI	PG9	25	4	x 1.4mm	71.406-MI
PG9	25	2	x 1.0mm	71.403-MI	PG9	25	4	x 3.0mm	71.407-MI

#### Multiple Diameters

Size	Std. Pk.	No. of Holes	Hole Qty. x Dia.	Hole Qty. x Dia.	Cat. No. White
PG9	25	2	(1 x 4.0mm) +	(1 x 6.0mm)	71.408-MI
PG9	25	3	(1 x 2.0mm) +	(2 x 4.0mm)	71.409-MI
PG9	25	3	(1 x 5.0mm) +	(2 x 4.0mm)	71.410-MI

### PG11

#### Same Diameter

Size	Std. Pk.	Hole Qty.	x Dia.	Cat. No. White	Size	Std. Pk.	Hole Qty.	x Dia.	Cat. No. White
PG11	25	1	x 3.0mm	71.420-MI	PG11	25	3	x 5.3mm	71.430-MI
PG11	25	1	x 4.0mm	71.421-MI	PG11	25	4	x 1.5mm	71.431-MI
PG11	25	1	x 5.0mm	71.422-MI	PG11	25	4	x 4.0mm	71.432-MI
PG11	25	2	x 2.3mm	71.423-MI	PG11	25	5	x 3.5mm	71.433-MI
PG11	25	2	x 3.0mm	71.424-MI	PG11	25	6	x 2.0mm	71.434-MI
PG11	25	2	x 4.0mm	71.425-MI	PG11	25	6	x 2.5mm	71.435-MI
PG11	25	2	x 5.0mm	71.426-MI	PG11	25	7	x 1.5mm	71.436-MI
PG11	25	2	x 6.0mm	71.427-MI	PG11	25	8	x 1.2mm	71.437-MI
PG11	25	3	x 3.0mm	71.428-MI	PG11	25	8	x 3.0mm	71.438-MI
PG11	25	3	x 4.0mm	71.429-MI	PG11	25	9	x 1.5mm	71.439-MI

### PG13.5

#### Same Diameter

Size	Std. Pk.	Hole Qty.	x Dia.	Cat. No. White	Size	Std. Pk.	Hole Qty.	x Dia.	Cat. No. White
PG13.5	25	1	x 6.0mm	71.450-MI	PG13.5	25	3	x 4.0mm	71.455-MI
PG13.5	25	2	x 5.0mm	71.451-MI	PG13.5	25	4	x 3.0mm	71.456-MI
PG13.5	25	2	x 6.0mm	71.452-MI	PG13.5	25	6	x 3.5mm	71.457-MI
PG13.5	25	3	x 2.0mm	71.453-MI	PG13.5	25	8	x 1.5mm	71.458-MI
PG13.5	25	3	x 3.0mm	71.454-MI	PG13.5	25	10	x 2.0mm	71.459-MI

#### Multiple Diameters

Size	Std. Pk.	No. of Holes	Hole Qty. x Dia.	Hole Qty. x Dia.	Hole Qty. x Dia.	Cat. No. White
PG13.5	25	3	(1 x 3.0mm) +	(2 x 6.0mm)		71.460-MI
PG13.5	25	3	(1 x 3.0mm) +	(1 x 6.0mm) +	(1x8.0mm)	71.461-MI
PG13.5	25	3	(1 x 5.5mm) +	(2 x 5.0mm)		71.462-MI

## PG16

### Same Diameter

Size	Std. Pk.	Hole Qty. x Dia.	Cat. No. White	Size	Std. Pk.	Hole Qty. x Dia.	Cat. No. White
PG16	25	1 x 4.0mm	71.470-MI	PG16	25	4 x 6.0mm	71.478-MI
PG16	25	1 x 5.0mm	71.471-MI	PG16	25	5 x 5.0mm	71.479-MI
PG16	25	2 x 4.0mm	71.472-MI	PG16	25	6 x 4.0mm	71.480-MI
PG16	25	2 x 6.0mm	71.473-MI	PG16	25	7 x 2.0mm	71.481-MI
PG16	25	2 x 8.0mm	71.474-MI	PG16	25	7 x 4.0mm	71.482-MI
PG16	25	2 x 9.0mm	71.475-MI	PG16	25	8 x 4.0mm	71.483-MI
PG16	25	3 x 7.0mm	71.476-MI	PG16	25	9 x 3.0mm	71.484-MI
PG16	25	3 x 8.0mm	71.477-MI	PG16	25	18 x 2.4mm	71.485-MI

### Multiple Diameters

Size	Std. Pk.	No. of Holes	Hole Qty. x Dia.	Hole Qty. x Dia.	Hole Qty. x Dia.	Cat. No. White
PG16	25	2	(1 x 3.0mm) +	(1 x 8.0mm)		71.486-MI
PG16	25	2	(1 x 3.0mm) +	(1 x 9.0mm)		71.487-MI
PG16	25	2	(1 x 6.0mm) +	(1 x 8.0mm)		71.488-MI
PG16	25	3	(1 x 3.0mm) +	(2 x 8.0mm)		71.489-MI
PG16	25	3	(1 x 4.5mm) +	(2 x 6.5mm)		71.490-MI
PG16	25	3	(1 x 5.0mm) +	(2 x 6.0mm)		71.491-MI
PG16	25	3	(1 x 5.5mm) +	(2 x 5.0mm)		71.492-MI
PG16	25	3	(1 x 6.0mm) +	(2 x 5.0mm)		71.493-MI
PG16	25	3	(1 x 7.0mm) +	(2 x 6.0mm)		71.494-MI
PG16	25	3	(1 x 8.0mm) +	(2 x 6.0mm)		71.495-MI
PG16	25	3	(1 x 3.0mm) +	(1 x 6.0mm) +	(1 x 8mm)	71.496-MI

## Accessories

Seal Rings: please refer to page 52.  
Locknuts: please refer to page 54.

## PG21

### Same Diameter

Size	Std. Pk.	Hole Qty. x Dia.	Cat. No. White	Size	Std. Pk.	Hole Qty. x Dia.	Cat. No. White
PG21	10	2 x 8.0mm	71.500-MI	PG21	10	5 x 9.5mm	71.510-MI
PG21	10	2 x 9.0mm	71.501-MI	PG21	10	6 x 4.0mm	71.511-MI
PG21	10	2 x 11.0mm	71.502-MI	PG21	10	6 x 5.0mm	71.512-MI
PG21	10	3 x 7.0mm	71.503-MI	PG21	10	6 x 5.5mm	71.513-MI
PG21	10	3 x 9.0mm	71.504-MI	PG21	10	6 x 7.5mm	71.514-MI
PG21	10	4 x 5.0mm	71.505-MI	PG21	10	8 x 3.0mm	71.515-MI
PG21	10	4 x 6.0mm	71.506-MI	PG21	10	8 x 4.0mm	71.516-MI
PG21	10	4 x 6.5mm	71.507-MI	PG21	10	8 x 5.0mm	71.517-MI
PG21	10	4 x 8.0mm	71.508-MI	PG21	10	11 x 5.2mm	71.518-MI
PG21	10	5 x 2.0mm	71.509-MI	PG21	10	21 x 2.0mm	71.519-MI

### Multiple Diameters

Size	Std. Pk.	No. of Holes	Hole Qty. x Dia.	Hole Qty. x Dia.	Hole Qty. x Dia.	Cat. No. White
PG21	10	2	(1 x 7.0mm) +	(1 x 10.5mm)		71.520-MI
PG21	10	2	(1 x 8.0mm) +	(1 x 14.0mm)		71.521-MI
PG21	10	2	(1 x 8.5mm) +	(1 x 12.0mm)		71.522-MI
PG21	10	2	(1 x 10.0mm) +	(1 x 12.0mm)		71.523-MI
PG21	10	3	(2 x 4.5mm) +	(1 x 13.0mm)		71.524-MI
PG21	10	3	(1 x 6.0mm) +	(2 x 9.0mm)		71.525-MI
PG21	10	3	(1 x 7.0mm) +	(1 x 8.0mm) +	(1 x 12.0mm)	71.526-MI
PG21	10	4	(2 x 5.0mm) +	(2 x 9.0mm)		71.527-MI
PG21	10	4	(2 x 6.0mm) +	(2 x 8.0mm)		71.528-MI
PG21	10	4	(2 x 6.0mm) +	(2 x 10.0mm)		71.529-MI
PG21	10	6	(4 x 5.0mm) +	(2 x 3.2mm)		71.530-MI
PG21	10	7	(6 x 4.0mm) +	(1 x 7.0mm)		71.531-MI

Metric to Inch Measurement Conversion  
Millimeters ÷ (25.4) = Inches  
Inches x (25.4) = Millimeters



## PG29

### Same Diameter

Size	Std. Pk.	Hole Qty.	x Dia.	Cat. No. White	Size	Std. Pk.	Hole Qty.	x Dia.	Cat. No. White
PG29	5	2	x 11.0mm	71.540-MI	PG29	5	5	x 10.0mm	71.549-MI
PG29	5	2	x 13.0mm	71.541-MI	PG29	5	6	x 6.0mm	71.550-MI
PG29	5	3	x 11.0mm	71.543-MI	PG29	5	6	x 8.0mm	71.551-MI
PG29	5	4	x 5.5mm	71.544-MI	PG29	5	7	x 7.0mm	71.552-MI
PG29	5	4	x 8.0mm	71.545-MI	PG29	5	8	x 5.5mm	71.553-MI
PG29	5	4	x 9.0mm	71.546-MI	PG29	5	10	x 6.0mm	71.554-MI
PG29	5	5	x 8.0mm	71.547-MI	PG29	5	12	x 5.3mm	71.555-MI
PG29	5	5	x 9.0mm	71.548-MI					

### Multiple Diameters

Size	Std. Pk.	No. of Holes	Hole Qty. x Dia.	Hole Qty. x Dia.	Hole Qty. x Dia.	Cat. No. White
PG29	5	2	(1 x 6.5mm) +	(1 x 17.0mm)		71.556-MI
PG29	5	2	(1 x 9.0mm) +	(1 x 15.0mm)		71.557-MI
PG29	5	2	(1 x 10.5mm) +	(1 x 16.0mm)		71.558-MI
PG29	5	2	(1 x 12.0mm) +	(1 x 13.0mm)		71.559-MI
PG29	5	3	(1 x 6.0mm) +	(1 x 8.5mm) +	(1 x 1.5mm)	71.560-MI
PG29	5	3	(2 x 6.5mm) +	(1 x 10.0mm)		71.561-MI
PG29	5	3	(2 x 8.5mm) +	(1 x 13.5mm)		71.562-MI
PG29	5	3	(1 x 9.0mm) +	(1 x 10.0mm) +	1 x 11mm)	71.563-MI
PG29	5	5	(4 x 4.5mm) +	(1 x 8.0mm)		71.565-MI
PG29	5	6	(2 x 4.0mm) +	(2 x 5.0mm) +	(2 x 8mm)	71.566-MI
PG29	5	6	(3 x 7.0mm) +	(3 x 8.0mm)		71.567-MI
PG29	5	7	(4 x 6.0mm) +	(3 x 8.5mm)		71.568-MI
PG29	5	7	(3 x 7.0mm) +	(4 x 10.0mm)		71.569-MI
PG29	5	7	(2 x 7.0mm) +	(4 x 3.5mm) +	(1 x 11mm)	71.570-MI

## PG36

### Same Diameter

Size	Std. Pk.	Hole Qty.	x Dia.	Cat. No. White	Size	Std. Pk.	Hole Qty.	x Dia.	Cat. No. White
PG36	5	2	x 15.0mm	71.580-MI	PG36	5	7	x 9.0mm	71.587-MI
PG36	5	2	x 17.0mm	71.581-MI	PG36	5	8	x 8.0mm	71.588-MI
PG36	5	3	x 10.0mm	71.582-MI	PG36	5	8	x 9.0mm	71.589-MI
PG36	5	4	x 10.2mm	71.583-MI	PG36	5	11	x 8.0mm	71.590-MI
PG36	5	4	x 11.5mm	71.584-MI	PG36	5	13	x 7.0mm	71.591-MI
PG36	5	4	x 13.0mm	71.585-MI	PG36	5	15	x 5.0mm	71.592-MI
PG36	5	5	x 11.5mm	71.586-MI					

### Multiple Diameters

Size	Std. Pk.	No. of Holes	Hole Qty. x Dia.	Hole Qty. x Dia.	Hole Qty. x Dia.	Cat. No. White
PG36	5	2	(1 x 11.0mm) +	(1 x 21.0mm)		71.593-MI
PG36	5	2	(1 x 12.5mm) +	(1 x 16.5mm)		71.594-MI
PG36	5	2	(1 x 14.0mm) +	(1 x 17.0mm)		71.595-MI
PG36	5	3	(1 x 13.0mm) +	(2 x 16.5mm)		71.596-MI

## HIGH PERFORMANCE PVC POLYVINYLCHLORIDE (PV) SOLID CORE INSERT





### Solid

Size	Std. Pk.	Cat. No. White	Size	Std. Pk.	Cat. No. White
PG9	25	71.621-MI	PG21	10	71.625-MI
PG11	25	71.622-MI	PG29	5	71.626-MI
PG13.5	25	71.623-MI	PG36	5	71.627-MI
PG16	25	71.624-MI			

Metric to Inch Measurement Conversion  
Millimeters ÷ (25.4) = Inches  
Inches x (25.4) = Millimeters

# HIGH PERFORMANCE MULTI-CONDUCTOR CORD GRIP WORKSHEET FOR SOLID CORE INSERTS

## Solid Core Insert Template

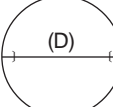
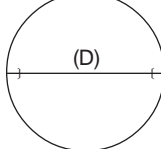
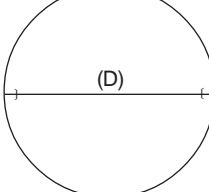
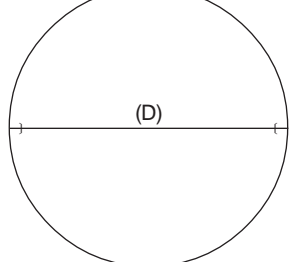
Available Drilling Area Diameter (D)		For Use In Cord Grip Size
10mm (.39 in.)		PG9
11mm (.43 in.)		PG11
13mm (.51 in.)		PG13.5
16mm (.63 in.)		PG16
21mm (.83 in.)		PG21
28mm (1.10 in.)		PG29
37mm (1.46 in.)		PG36

## General Information

Use this worksheet to determine drill patterns or to communicate hole locations, quantity and diameters to Altech if you want us to drill holes for you (low to medium quantities) or, for higher quantities, to instruct us how to create a special molding tool to custom mold inserts for you.

Drill holes by using a standard high-speed steel drill bit of the proper size at approx. 800 RPM<sup>1</sup>. To facilitate drilling we recommend to cool the solid core inserts to 7°C (45°F). Drill holes with Insert installed into Cord Grip. See cutaway illustration below. Keep a distance of 1mm (.04 in.) between holes on all sides. However, the outside holes can be located right against the lip of the strain relief body (shown on top of cutaway illustration) as sufficient insert material remains between the hole and the body wall, due to the design of the Cord Grip.

The useable area of the various Cord Grip sizes is shown by PG size in mm and inches at a 1:1 scale. Please feel free to copy this worksheet and use the template to prepare your own drilling pattern or to communicate the pattern to Altech.

## Shop Drilling

- Slip Insert into Cord Grip.
- Tighten Pressure-Dome of Cord Grip prior to drilling.
- Place Cord Grip into vise.
- Drill holes.
- Cool drill bit with air or water if required.
- A tolerance of + 1 mm (0.04 in.) should not be exceeded to ensure proper sealing.
- Keep a distance of 1mm(.04 in.) between holes on all sides.

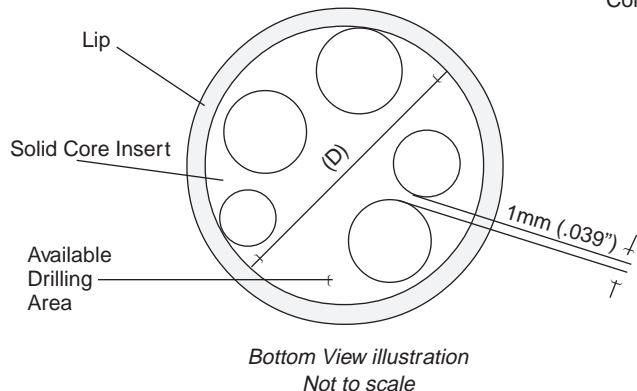
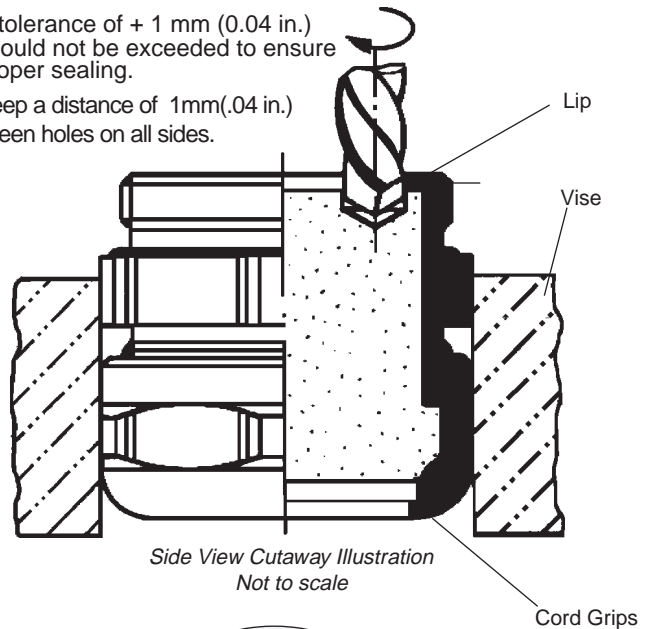

<sup>1</sup> Do not exceed 1,000 RPM as PVC Polyvinylchloride (PV) insert material might overheat and possibly melt.

## HIGH PERFORMANCE EMI / RFI

### Brass, Nickel Plated (BN)

Provide sealing and strain relief plus shielding against electromagnetic and radio frequency interference. For more information about EMI / RFI Cord Grips, please refer to page 26.

- IP68 (NEMA 1, 2, 3, 3R, 4, 4X, 5, 6, 12, 13) / 10Bar (140 psi).
- PG standard.
- Preinstalled Perbunan (PR) Seal Ring.
- Order EMI / RFI or regular Locknuts separately if required. Please refer to pages 26 for general information and page 54 for ordering.



### Brass, Nickel Plated (BN) with Santoprene (ST) Tubular Sealing Insert

Liquid Tight Strain Reliefs (Cord Grips)											
Body Material		Brass, Nickel Plated (BN)									
Body Temperature Range		-40 to 300°C (-40 to 572°F)									
Sealing Insert Material		Santoprene (ST)									
Temperature Range		-60 to 125°C (-65 to 257°F)									
Sealing Insert Color		Beige									
Seal Ring Material		Perbunan (PR)									
Seal Ring Temperature Range		-20 to 120°C (-4 to 248°F)									
Type	Std. Pk.	Cable Dia.		Shield Dia. Min.		Shield Dia. Min.		Mtg. Hole Dia. <sup>1</sup>		Nearest Drill Size	Cat. No.
		mm	(in.)	mm	(in.)	mm	(in.)	mm	(in.)		
PG9-STBN-BNST 06	5	4.0 - 6.0	(.16- .24)	1.5	(.06)	4.0	(.16)	15.5	(.61)	39/64	71.300
PG9-STBN-BNST 09	5	7.0 - 9.5	(.27- .37)	1.5	(.06)	6.5	(.26)	15.5	(.61)	39/64	71.301
PG11-STBN-BNST 06	5	6.0 - 8.0	(.24- .31)	3.0	(.12)	7.0	(.28)	19.0	(.75)	3/4	71.302
PG11-STBN-BNST 09	5	6.0 - 9.5	(.24- .37)	3.5	(.14)	8.0	(.31)	19.0	(.75)	3/4	71.303
PG11-STBN-BNST 10	5	8.0 - 10.5	(.31- .41)	4.0	(.16)	8.5	(.33)	19.0	(.75)	3/4	71.304
PG13.5-STBN-BNST 06	5	4.0 - 6.0	(.16- .24)	2.5	(.10)	6.0	(.24)	21.0	(.83)	53/64	71.305
PG13.5-STBN-BNST 09	5	6.0 - 9.5	(.24- .37)	5.0	(.20)	8.0	(.31)	21.0	(.83)	53/64	71.306
PG13.5-STBN-BNST 10	5	8.0 - 10.5	(.31- .41)	5.0	(.20)	8.0	(.31)	21.0	(.83)	53/64	71.307
PG16-STBN-BNST 09	5	6.0 - 9.5	(.24- .37)	6.0	(.24)	9.0	(.35)	23.0	(.91)	29/32	71.308
PG16-STBN-BNST 10	5	8.0 - 10.5	(.31- .41)	6.0	(.24)	9.0	(.35)	23.0	(.91)	29/32	71.309
PG16-STBN-BNST 11	5	10.0 - 11.5	(.39- .45)	6.5	(.26)	10.0	(.39)	23.0	(.91)	29/32	71.310
PG16-STBN-BNST 14	5	10.0 - 14.0	(.39- .55)	8.0	(.31)	12.0	(.47)	23.0	(.91)	29/32	71.311
PG16-STBN-BNST 16	5	14.0 - 16.5	(.55- .65)	8.0	(.31)	12.0	(.47)	23.0	(.91)	29/32	71.312
PG21-STBN-BNST 10	3	8.0 - 10.5	(.31- .41)	8.0	(.31)	10.0	(.39)	29.0	(1.14)	1-9/64	71.313
PG21-STBN-BNST 14	3	10.0 - 14.0	(.39- .55)	8.0	(.31)	12.0	(.47)	29.0	(1.14)	1-9/64	71.314
PG21-STBN-BNST 16	3	14.0 - 16.5	(.55- .64)	8.0	(.31)	12.0	(.47)	29.0	(1.14)	1-9/64	71.315
PG21-STBN-BNST 18	3	15.0 - 18.0	(.59- .71)	12.5	(.49)	17.5	(.69)	29.0	(1.14)	1-9/64	71.316
PG21-STBN-BNST 20	3	17.0 - 20.0	(.67- .79)	12.5	(.49)	17.5	(.69)	29.0	(1.14)	1-9/64	71.317
PG29-STBN-BNST 23	1	19.0 - 23.0	(.74- .90)	15.0	(.59)	21.0	(.83)	37.5	(1.48)	1-31/64	71.318
PG29-STBN-BNST 27	1	22.0 - 27.0	(.86- 1.06)	15.0	(.59)	21.0	(.83)	37.5	(1.48)	1-31/64	71.319
PG36-STBN-BNST 30	1	25.0 - 30.0	(.98- 1.18)	18.0	(.71)	25.0	(.98)	47.5	(1.87)	1-7/8	71.320
PG36-STBN-BNST 32	1	29.0 - 32.0	(1.14- 1.26)	24.0	(.94)	30.0	(1.18)	47.5	(1.87)	1-7/8	71.321
PG42-STBN-BNST 41	1	37.0 - 41.0	(1.45- 1.61)	29.0	(1.14)	33.0	(1.30)	54.5	(2.15)	2-5/32	71.322

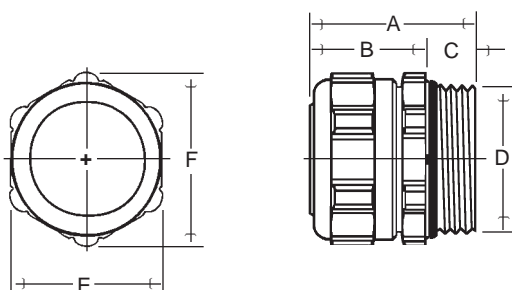

#### Dimensions mm (in.)

Size	A	B	C	D	E	F
PG9	41.0 (1.61)	31.0 (1.22)	10.0 (.39)	15.2 (.60)	24.0	26.7 (1.05)
PG11	41.0 (1.61)	31.0 (1.22)	10.0 (.39)	18.6 (.73)	24.0	26.7 (1.05)
PG13.5	41.0 (1.61)	31.0 (1.22)	10.0 (.39)	20.4 (.80)	24.0	26.7 (1.05)
PG16	43.0 (1.70)	32.0 (1.26)	11.0 (.43)	22.5 (.89)	30.0	33.5 (1.32)
PG21	44.0 (1.73)	34.0 (1.34)	12.0 (.47)	28.3 (1.11)	30.0	33.5 (1.32)
PG29	52.0 (2.05)	39.0 (1.54)	13.0 (.51)	37.0 (1.46)	40.0	43.5 (1.71)
PG36	59.0 (2.32)	45.0 (1.77)	14.0 (.55)	47.0 (1.85)	50.0	54.0 (2.13)
PG42	65.0 (2.56)	50.0 (1.97)	15.0 (.59)	54.0 (2.13)	60.0	65.0 (2.56)

<sup>1</sup> For installation into nonthreaded holes with Locknuts. For additional information please refer to the Installation Worksheet, page 55.



#### Installation

To install, we recommend the use of Socket (Refer to page 53), Metric Open-end or Adjustable Wrenches. Please refer to column "E" in the Dimensions Table for sizes.

# HIGH PERFORMANCE FLAT CABLE

## Polyamide (PA) and Brass, Nickel Plated (BN)

- IP 65 (NEMA 1, 2, 3, 3R, 5, 12, 13).
- PG standard.
- Brass, Nickel Plated (BN) Cord Grips feature preinstalled Perbunan (PR) Seal Rings. Order Seal Rings separately for Polyamide (PA) Cord Grips if required.
- Order Locknuts separately if required.
- Standard color of body: Beige or Black Polyamide (PA) or Brass, Nickel Plated (BN) if required.



## Polyamide (PA) Bodies

### Liquid Tight Strain Reliefs (Cord Grips)

**Body Material**

**Body Temperature Range**

**Sealing Insert Material**

**Sealing Insert Temperature Range**

**Sealing Insert Color**

**Seal Ring Material**

**Seal Ring Temperature Range**

**Polyamide (PA)**

**-20 to 100°C (-4 to 212°F)**

Type	Std. Pk.	Mtg. Hole Dia. <sup>1</sup> mm (in.)	Nearest Drill Size	Cat. No. Beige	Cat. No. Black
PG9-PF □□ - □□ BE 05	15	15.5 (.61)	39/64	<b>71.701</b>	<b>71.711</b>
PG11-PF □□ - □□ BE 06	15	19.0 (.75)	3/4	<b>71.702</b>	<b>71.712</b>
PG11-PF □□ - □□ BE 09	15	19.0 (.75)	3/4	<b>71.702</b>	<b>71.712</b>
PG11-PF □□ - □□ BE 10	15	19.0 (.75)	3/4	<b>71.702</b>	<b>71.712</b>
PG13.5-PF □□ - □□ BE 11	10	21.0 (.83)	53/64	<b>71.703</b>	<b>71.713</b>
PG13.5-PF □□ - □□ BE 12	10	21.0 (.83)	53/64	<b>71.703</b>	<b>71.713</b>
PG16-PF □□ - □□ BE 12	10	23.0 (.91)	29/32	<b>71.704</b>	<b>71.714</b>
PG16-PF □□ - □□ BE 14	10	23.0 (.91)	29/32	<b>71.704</b>	<b>71.714</b>
PG21-PF □□ - □□ BE 17	5	29.0 (1.14)	1-9/64	<b>71.705</b>	<b>71.715</b>
PG21-PF □□ - □□ BE 18	5	29.0 (1.14)	1-9/64	<b>71.705</b>	<b>71.715</b>
PG21-PF □□ - □□ BE 15	5	29.0 (1.14)	1-9/64	<b>71.705</b>	<b>71.715</b>
PG29-PF □□ - □□ BE 29	5	37.5 (1.48)	1-31/64	<b>71.706</b>	<b>71.716</b>
PG29-PF □□ - □□ BE 25	5	37.5 (1.48)	1-31/64	<b>71.706</b>	<b>71.716</b>
PG36-PF □□ - □□ BE 30	5	47.5 (1.87)	1-7/8	<b>71.707</b>	<b>71.717</b>
PG36-PF □□ - □□ BE 34	5	47.5 (1.87)	1-7/8	<b>71.707</b>	<b>71.717</b>
PG42-PF □□ - □□ BE 38	2	54.5 (2.15)	2-5/32	<b>71.708</b>	—
PG48-PF □□ - □□ BE 43	2	60.0 (2.36)	2-3/8	<b>71.709</b>	—

Body Color, Example: Beige **[B][E]** or Black **[B][K]**  
 Body Material, Example: Polyamide **[P][A]** or Brass, Nickel Plated **[B][N]**

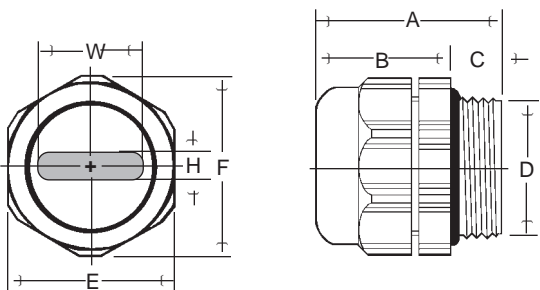

### Polyamide Dimensions mm (in.)

Size	A	B	C	D	E	F
PG9	31.0 (1.22)	22.0 (.87)	9.0 (.35)	15.2 (.60)	19.0	21.0 (.83)
PG11	32.0 (1.26)	23.0 (.91)	9.0 (.35)	18.6 (.73)	22.0	24.5 (1.00)
PG13.5	33.0 (1.30)	23.0 (.91)	9.0 (.35)	20.4 (.80)	24.0	26.5 (1.04)
PG16	32.0 (1.26)	23.0 (.91)	9.5 (.37)	22.5 (.89)	27.0	29.5 (1.16)
PG21	38.0 (1.48)	27.0 (1.06)	11.0 (.43)	28.3 (1.11)	33.0	36.5 (1.44)
PG29	45.5 (1.79)	34.0 (1.34)	11.5 (.45)	37.0 (1.46)	43.0	46.0 (1.81)
PG36	48.0 (1.89)	34.0 (1.34)	14.0 (.55)	47.0 (1.85)	53.0	57.0 (2.24)
PG42	53.0 (2.09)	38.0 (1.48)	15.0 (.59)	54.0 (2.13)	60.0	64.0 (2.52)
PG48	53.0 (2.09)	38.0 (1.48)	15.0 (.59)	59.3 (2.33)	65.0	70.0 (2.76)

<sup>1</sup> For installation into nonthreaded holes with Locknuts. Please refer to page 5 for installation instructions.

Note: Flat cable cord grips are also available in PVDF and Stainless Steel with PVC Polyvinylchloride insert. Inserts for other than listed cable dimensions are available. Please contact Altech



#### Installation

To install, we recommend the use of Socket (Refer to page 53), Metric Open-end or Adjustable Wrenches. Please refer to column "E" in the Dimensions Table for sizes.



## Brass, Nickel Plated (BN) Bodies

Brass, Nickel Plated (BN)  
-40 to 300°C (-40 to 572°F)

Perbunan (PR)  
-20 to 120°C (-4 to 248°F)

Cat. No.  
Beige

71.731  
71.732  
71.732  
71.732  
71.733  
71.733  
  
71.734  
71.734  
71.735  
71.735  
71.735  
71.736  
71.736  
71.737  
71.737  
71.738  
71.739



## PVC Polyvinylchloride (PV) Sealing Insert, Rounded Sides\*

PVC Polyvinylchloride (PV)  
-20 to 80°C (-4 to 176°F)  
White

Type  
Std. Pk.  
Opening Dim. mm  
HxW (in.)

Type	Std. Pk.	Opening Dim. mm	HxW (in.)
PG9-PF	15	3.5 x 5.5	(.14 x .22)
PG11-PF	15	4.0 x 6.0	(.16 x .24)
PG11-PF	15	3.5 x 9.0	(.14 x .35)
PG11-PF	15	2.8 x 10.5	(.11 x .41)
PG13.5-PF	10	5.0 x 11.0	(.20 x .43)
PG13.5-PF	10	3.0 x 12.0	(.12 x .47)
PG16-PF	10	5.0 x 12.0	(.20 x .47)
PG16-PF	10	7.5 x 14.0	(.30 x .55)
PG21-PF	5	5.0 x 17.0	(.20 x .67)
PG21-PF	5	7.0 x 18.0	(.28 x .71)
PG21-PF	5	9.0 x 15.0	(.35 x .59)
PG29-PF	5	6.0 x 29.0	(.24 x 1.14)
PG29-PF	5	8.0 x 25.0	(.31 x .98)
PG36-PF	5	6.0 x 30.0	(.24 x 1.18)
PG36-PF	5	11.0 x 34.0	(.43 x 1.34)
PG42-PF	2	10.0 x 38.0	(.39 x 1.50)
PG48-PF	2	9.0 x 43.0	(.35 x 1.69)

Cat. No.  
White

71.160-FI  
71.161-FI  
71.162-FI  
71.163-FI  
71.164-FI  
71.165-FI  
  
71.166-FI  
71.167-FI  
71.168-FI  
71.169-FI  
71.170-FI  
71.171-FI  
71.172-FI  
71.173-FI  
71.174-FI  
71.175-FI  
71.176-FI



## PVC Polyvinylchloride (PV) Sealing Insert, Oval Openings\*

PVC Polyvinylchloride (PV)  
-20 to 80°C (-4 to 176°F)  
White

Type  
Std. Pk.  
Opening Dim. mm  
HxW (in.)  
Cat. No.  
White

Type	Std. Pk.	Opening Dim. mm	HxW (in.)	Cat. No. White
—	—	—	—	—
—	—	—	—	—
—	—	—	—	—
—	—	—	—	—
PG13.5-PF	10	5.0 x 8.0	(.20 x .31)	71.140-FI
PG13.5-PF	10	5.0 x 12.0	(.20 x .47)	71.141-FI
PG16-PF	10	6.0 x 15.0	(.24 x .59)	71.142-FI
PG16-PF	10	7.0 x 14.0	(.28 x .55)	71.143-FI
PG21-PF	5	5.0 x 16.0	(.20 x .63)	71.144-FI
PG21-PF	5	7.0 x 16.5	(.28 x .65)	71.145-FI
PG21-PF	5	7.0 x 20.0	(.28 x .79)	71.146-FI
—	—	—	—	—
PG29-PF	5	10.0 x 27.0	(.39 x 1.06)	71.147-FI
PG36-PF	5	6.5 x 32.0	(.26 x 1.26)	71.148-FI
PG36-PF	5	11.0 x 35.0	(.43 x 1.38)	71.149-FI
PG42-PF	2	9.0 x 38.0	(.35 x 1.50)	71.150-FI
—	—	—	—	—

### Accessories

For information on Seal Rings, please refer to page 52.

For information on Locknuts, please refer to page 54.

### Brass, Nickel Plated Dimensions mm (in.)

Size	A	B	C	D	E	F
PG9	26.0 (1.02)	20.0 (.79)	6.0 (.24)	15.2 (.60)	17.0	18.9 (.74)
PG11	26.0 (1.02)	20.0 (.79)	6.0 (.24)	18.6 (.73)	20.0	22.2 (.87)
PG13.5	27.5 (1.08)	21.0 (.83)	6.5 (.26)	20.4 (.80)	22.0	24.4 (.96)
PG16	27.5 (1.08)	21.0 (.83)	6.5 (.26)	22.5 (.89)	24.0	26.7 (1.05)
PG21	32.0 (1.26)	25.0 (.98)	7.0 (.28)	28.3 (1.11)	30.0	33.5 (1.32)
PG29	35.0 (1.38)	27.0 (1.06)	8.0 (.31)	37.0 (1.46)	40.0	43.5 (1.71)
PG36	37.0 (1.46)	28.0 (1.10)	9.0 (.35)	47.0 (1.85)	50.0	54.0 (2.24)
PG42	40.0 (1.57)	30.0 (1.18)	10.0 (.39)	54.0 (2.13)	57.0	61.0 (2.40)
PG48	40.0 (1.57)	30.0 (1.18)	10.0 (.39)	59.3 (2.33)	64.0	69.0 (2.72)

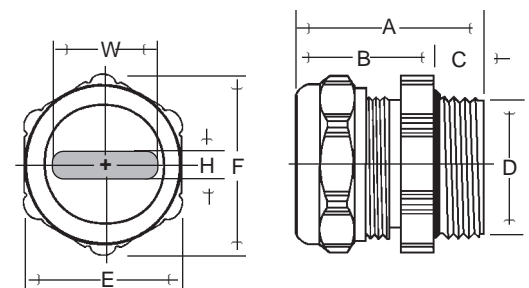

### \*Tolerances

Minimum cable size should not be less than .5mm (.02 in.) in width and height than opening in Cord Grip.

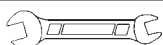

**Installation**  
To install, we recommend the use of Socket (Refer to page 53), Metric Open-end or Adjustable Wrenches. Please refer to column "E" in the Dimensions Table for sizes.





---

Economy Liquid Tight Strain Reliefs (Cord Grips) are ideal for basic, straight-through applications. These Cord Grips seal cable/cord entries and prevent contaminants from entering into enclosures. They can be used with cables, cords, etc.

**Body Material**

- Polystyrene (PS)
- Brass, Nickel Plated (BN)

**Sealing Ring Material**

- Rubber (RU)

**Function**

- Straight-Through

**Protection Rating**

Up to IP54  
(NEMA 1, 2, 5, 12,13)

---

# ECONOMY

## ECONOMY STRAIGHT-THROUGH

### Polystyrene (PS) and Brass, Nickel Plated (BN)

- IP54 (NEMA 1, 2, 5, 12,13).
- PG standard.
- We recommend the use of Polyethylene (PE) Seal Rings with Polyamide (PA) and Perbunan (PR) with Brass, Nickel Plated (BN) Cord Grips. Order Seal Rings separately. Refer to page 52 for technical and ordering information.
- Order Locknuts separately if required. We recommend the use of Polyamide (PA) Locknuts with Polyamide (PA) Cord Grips and Brass, Nickel Plated (BN) Locknuts with Brass, Nickel Plated (BN) Cord Grips. Refer to page 54 for more information on Locknuts.
- Standard color: Light Gray Polystyrene (PS) or Brass, Nickel Plated (BN).

Temperature Ranges	
Body	Sealing Ring
Polystyrene (PS) -20 to 65°C (-4 to 149°F)	Rubber (RU) -20 to 80°C (-4 to 176°F)
Brass, Nickel Plated (BN) -40 to 300°C (-40 to 572°F)	Rubber (RU) -20 to 80°C (-4 to 176°F)



**Polystyrene (PS)  
with Rubber (RU) Sealing Ring**



**Brass, Nickel Plated (BN)  
with Rubber (RU) Sealing Ring**

### Liquid Tight Strain Reliefs (Cord Grips)

Cable Dia. mm (in.)	Mtg. Hole Dia. <sup>1</sup> mm (in.)	Nearest Drill Size <sup>1</sup>	Type	Cat. No.	Std. Pk.	Type	Cat. No.	Std. Pk.
5.0 - 7.0 (.20 - .28)	13.0 (.51)	33/64	PG7-ESPS- LG RU 07	<b>80.600</b>	100	PG7-ESBN- [ ] RU 07	<b>80.610</b>	100
6.0 - 8.0 (.24 - .31)	15.5 (.61)	39/64	PG9-ESPS- LG RU 08	<b>80.601</b>	100	PG9-ESBN- [ ] RU 08	<b>80.611</b>	100
8.0 - 10.0 (.31 - .39)	19.0 (.75)	3/4	PG11-ESPS- LG RU 10	<b>80.602</b>	100	PG11-ESBN- [ ] RU 10	<b>80.612</b>	50
10.0 - 12.0 (.39 - .47)	21.0 (.83)	53/64	PG13.5-ESPS- LG RU 12	<b>80.603</b>	100	PG13.5-ESBN- [ ] RU 12	<b>80.613</b>	50
12.0 - 14.0 (.47 - .55)	23.0 (.91)	29/32	PG16-ESPS- LG RU 14	<b>80.604</b>	50	PG16-ESBN- [ ] RU 14	<b>80.614</b>	50
15.0 - 17.0 (.59 - .67)	29.0 (1.14)	1-9/64	PG21-ESPS- LG RU 17	<b>80.605</b>	50	PG21-ESBN- [ ] RU 17	<b>80.615</b>	50
24.0 - 26.0 (.94 - 1.02)	37.5 (1.48)	1-31/64	PG29-ESPS- LG RU 26	<b>80.606</b>	25	PG29-ESBN- [ ] RU 26	<b>80.616</b>	25
31.0 - 33.0 (1.22 - 1.30)	47.5 (1.87)	1-7/8	PG36-ESPS- LG RU 33	<b>80.607</b>	10	PG36-ESBN- [ ] RU 33	<b>80.617</b>	10
39.0 - 41.0 (1.54 - 1.61)	54.5 (2.15)	2-5/32	PG42-ESPS- LG RU 41	<b>80.608</b>	5	PG42-ESBN- [ ] RU 41	<b>80.618</b>	5
45.0 - 47.0 (1.77 - 1.85)	60.0 (2.36)	2-3/8	PG48-ESPS- LG RU 47	<b>80.609</b>	5	PG48-ESBN- [ ] RU 47	<b>80.619</b>	5

### Dimensions mm (in.) Size

	A	B	C	D	E	F
<b>Polystyrene (PS)</b>						
PG7	29.0 (1.14)	22.0 (.87)	8.0 (.31)	12.5 (.49)	15.0	16.0 (.63)
PG9	31.5 (1.24)	23.5 (.93)	8.0 (.31)	15.2 (.60)	19.0	20.5 (.81)
PG11	33.0 (1.30)	25.0 (.98)	8.0 (.31)	18.6 (.73)	22.0	24.0 (.94)
PG13.5	36.0 (1.42)	26.5 (1.04)	9.5 (.37)	20.4 (.80)	24.0	26.0 (1.02)
PG16	40.5 (1.59)	30.5 (1.20)	10.0 (.39)	22.5 (.89)	27.0	29.0 (1.14)
PG21	43.5 (1.71)	32.5 (1.28)	11.0 (.43)	28.3 (1.11)	32.0	35.5 (1.40)
PG29	46.0 (1.81)	35.0 (1.38)	11.0 (.43)	37.0 (1.46)	42.0	45.5 (1.79)
PG36	57.0 (2.24)	44.0 (1.73)	13.0 (.51)	47.0 (1.85)	53.0	57.0 (2.24)
PG42	61.0 (2.40)	48.0 (1.89)	13.0 (.51)	54.0 (2.13)	60.0	65.0 (2.56)
PG48	60.0 (2.36)	46.0 (1.81)	14.0 (.55)	59.3 (2.33)	65.0	70.0 (2.76)
<b>Brass, Nickel Plated (BN)</b>						
PG7	21.0 (.83)	16.0 (.63)	5.0 (.18)	12.5 (.49)	14.0	15.5 (.61)
PG9	22.5 (.89)	16.5 (.65)	6.0 (.24)	15.2 (.60)	17.0	18.9 (.74)
PG11	24.0 (.94)	18.0 (.71)	6.0 (.24)	18.6 (.73)	20.0	22.2 (.87)
PG13.5	25.5 (1.00)	19.0 (.75)	6.5 (.26)	20.4 (.80)	22.0	24.4 (.96)
PG16	26.5 (1.04)	20.0 (.79)	6.5 (.26)	22.5 (.89)	24.0	26.5 (1.04)
PG21	30.0 (1.18)	23.0 (.91)	7.0 (.28)	28.3 (1.11)	30.0	33.5 (1.32)
PG29	33.0 (1.30)	25.0 (.98)	8.0 (.31)	37.0 (1.46)	40.0	44.0 (1.73)
PG36	39.0 (1.54)	30.0 (1.18)	9.0 (.35)	47.0 (1.85)	50.0	54.0 (2.13)
PG42	44.0 (1.73)	34.0 (1.34)	10.0 (.39)	54.0 (2.13)	57.0	61.0 (2.40)
PG48	46.0 (1.81)	36.0 (1.42)	10.0 (.39)	59.3 (2.33)	64.0	69.0 (2.72)

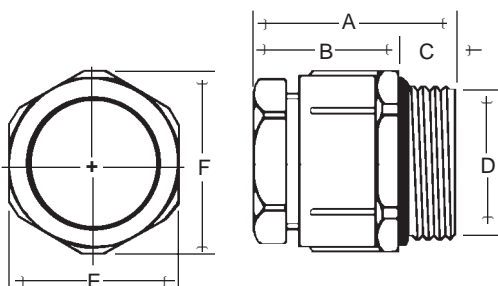

(Polystyrene (RS) Cord Grip Shown)

<sup>1</sup> For installation into nonthreaded holes with Locknuts. Please refer to page 5 for installation instructions.



### Installation

To install, we recommend the use of Socket (Refer to page 53), Metric Open-end or Adjustable Wrenches. Please refer to column "E" in the Dimensions Table for sizes.

## ACCESSORIES

### Seal Rings - page 52

Provide an external seal between the Cord Grip body and the enclosure wall. Some Cord Grips have preinstalled Seal Rings. If the material of the preinstalled Seal Ring is not suitable for your application due to presence of chemicals, temperature or environmental conditions, choose a Seal Ring that will stand up to the expected environment.

Altech offers four different Seal Ring materials:

- Polyethelene (PE)
- Perbunan (PR)
- Silicone (SI)
- Centellen (CT)

### Sealing Plugs - page 52

Sealing Plugs are available to seal unused holes, ensuring strain relief and IP65 (NEMA 1, 2, 3, 3R, 5, 12, 13) protection rating.

### Socket Wrenches - page 53

We recommend the use of Socket Wrenches to install Cord Grips into enclosure walls. These Socket Wrenches are especially useful for high density installations. Please refer to page 53 for ordering information.

### Locknuts - page 54

Use Locknuts for installations of Cord Grips into nonthreaded holes. Polyamide (PA) Locknuts are typically used for nonmetallic Cord Grips. However, Brass, Nickel Plated (BN) and Stainless Steel (SS) Locknuts can be used as well with these Cord Grips, especially if the available thread length is short or space is limited.

Brass, Nickel Plated (BN) Locknuts are typically used with Brass, Nickel Plated (BN) Cord Grips and Stainless Steel (SS) Locknuts are typically used with Stainless Steel (SS) Cord Grips.

EMI / RFI Locknuts have a specific function. Please refer to page 26 for information about these Locknuts.

Ordering information can be found on page 54.

## Seal Rings

### Standard

Polyamide (PA):

- Sizes PG7 to PG21 and NPT 3/8" to 3/4" have Integral Sealing Ridges
- Sizes PG29 to PG48 feature preinstalled Perbunan (PR) Seal Rings.

### High Performance

Nonmetallic:

- Seal Rings not included - order separately if required.

Metal:

- Perbunan (PR) or Silicone (SI) Seal Ring are preinstalled depending on type. Refer to ordering pages.

### Economy

Polystyrene (PS) and Brass, Nickel Plated (BN):

- Seal Rings not included - order separately if required.



Polyethylene (PE) - Opaque



Perbunan (PR) - Black



Silicon (SI) - Red



Centellen (CT) - Red

Material	Polyethylene (PE)		Perbunan (PR)		Silicone (SI)		Centellen (CT)	
Temperature Range	-20 to 100°C (-4 to 212°F)		-20 to 120°C (-4 to 248°F)		-60 to 200°C (-65 to 392°F)		-60 to 300°C (-65 to 572°F)	
Size	Cat. No. Opaque	Std. Pk.	Cat. No. Black	Std. Pk.	Cat. No. Red	Std. Pk.	Cat. No. Red	Std. Pk.
PG7	86.600	100	86.700	100	—	—	79.000	50
PG9	86.601	100	86.701	100	86.721	10	79.001	50
PG11	86.602	100	86.702	50	86.722	10	79.002	50
PG13.5	86.603	100	86.703	50	86.723	10	79.003	50
PG16	86.604	50	86.704	50	86.724	5	79.004	25
PG21	86.605	50	86.705	50	86.725	5	79.005	25
PG29	86.606	20	86.706	25	86.726	5	79.006	20
PG36	86.607	10	86.707	10	86.727	5	79.007	10
PG42	86.608	5	86.708	5	—	—	79.008	5
PG48	86.609	5	86.709	5	—	—	79.009	5
NPT3/8	86.602	100	86.702	50	—	—	79.002	50
NPT1/2	86.603	100	86.703	50	—	—	79.003	50
NPT3/4	86.605	50	86.705	25	—	—	79.005	25

## Sealing Plugs

- Seal Unused Holes.
- Maintain Protection Rating of IP65 (NEMA 1, 2, 3, 3R, 5, 12, 13).

Sealing Plugs should be inserted into unused holes to maintain the rated seal and strain relief rating.

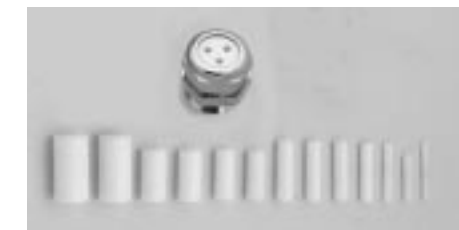

Type	Cat. No.	Size	Std.Pk.
SP1	86.750	3.0 x 25.0 (.12 x .98)	25
SP2	86.751	4.0 x 20.0 (.16 x .79)	25
SP3	86.752	4.0 x 25.0 (.16 x .98)	25
SP4	86.753	5.3 x 25.0 (.21 x .98)	25
SP5	86.754	6.0 x 25.0 (.24 x .98)	25
SP6	86.755	6.4 x 25.0 (.25 x .98)	25
SP7	86.756	7.0 x 25.0 (.28 x .98)	25
SP8	86.757	7.5 x 20.0 (.30 x .79)	25
SP9	86.758	8.0 x 20.0 (.32 x .79)	25
SP10	86.759	9.3 x 20.0 (.37 x .79)	25
SP11	86.760	10.0 x 20.0 (.39 x .79)	25
SP12	86.761	12.0 x 25.0 (.47 x .98)	25
SP13	86.762	13.0 x 25.0 (.51 x .98)	25

## Socket Wrenches

These metric tools are ideal for installing Cord Grips into enclosure walls and are especially useful for high density installations.

Numbers in the “**TYPE**” column refer to the “**E**” dimensions in millimeters stated throughout the catalog for all Liquid Tight Strain Reliefs and Locknuts. The “**E**” dimension is the width across the flats of Cord Grip bodies or Locknuts.

- Hardened steel, zinc plated.
- Movable handle.



			Suitable for Cord Grips				Suitable for Locknuts											
Type	E Dim. (mm)	Cat. No.	PVDF, PA,PS	BN	SS	EMI / RFI	PA	BN	SS	EMI/RFI								
SW14	14.0	<b>86.800</b>	PG7	PG7	PG7	PG9-PG13.5	PG7	PG7 NPT3/8 PG9	PG7, PG9	PG9								
SW15	15.0	<b>86.801</b>		PG9, NPT3/8	PG9													
SW17	17.0	<b>86.802</b>		PG11	PG11													
SW18	18.0	<b>86.803</b>		PG11, NPT3/8	PG13.5						PG13.5	PG9	PG11	PG11	PG11			
SW19	19.0	<b>86.804</b>																
SW20	20.0	<b>86.805</b>																
SW21	21.0	<b>86.806</b>		PG13.5	PG16, NPT1/2						PG16	PG9-PG13.5	PG11	NPT1/2 PG16	PG13.5	PG13.5 PG16		
SW22	22.0	<b>86.807</b>																
SW23	23.0	<b>86.808</b>																
SW24	24.0	<b>86.809</b>	PG16, NPT1/2			PG21, NPT3/4	PG21	PG16-PG21	PG13.5 PG16	NPT3/4 PG21							PG16	PG21
SW26	26.0	<b>86.810</b>																
SW27	27.0	<b>86.811</b>																
SW30	30.0	<b>86.812</b>	PG21, NPT3/4			PG29	PG29	PG29	PG21	PG29							PG29	PG21 PG29
SW32	32.0	<b>86.813</b>																
SW33	33.0	<b>86.814</b>																
SW35	35.0	<b>86.815</b>																
SW40	40.0	<b>86.817</b>																
SW41	41.0	<b>86.818</b>	PG29	PG36	PG36	PG36	PG36	PG36	PG36	PG36								
SW43	43.0	<b>86.819</b>																
SW50	50.0	<b>86.821</b>																
SW51	51.0	<b>86.822</b>																
SW53	53.0	<b>86.823</b>									PG36	PG42 PG48	PG42 PG48	PG42	PG48	PG42	PG48	PG42 PG48
SW57	57.0	<b>86.824</b>																
SW64	54.0	<b>86.825</b>																
SW65	65.0	<b>86.826</b>	PG48	PG48	PG48	PG48	PG48	PG48	PG48	PG48								
SW70	70.0	<b>86.827</b>																

# LOCKNUTS

Use Locknuts to install Cord Grips into nonthreaded holes

- PG, NPT standard.
- Metric available.
- Standard color: Light Gray and Black Polyamide (PA), Brass, Nickel Plated (BN) or Stainless Steel (SS).



**Polyamide (PA)**

**Brass, Ni Plated (BN)**

**Stainless Steel (SS)**

**EMI / RFI Brass, Ni Plated (BN)**

## Ordering Information

### Temperature Range

-20 to 100°C  
(-4 to 212°F)

-40 to 300°C  
(-40 to 572°F)

-50 to 500°C  
(-65 to 932°F)

-40 to 300°C  
(-40 to 572°F)

Size	AL	Cat. No. Gray	Cat. No. Black	Std. Pk.	Cat. No.	Std. Pk.	Cat. No.	Std. Pk.	Cat. No.	Std. Pk.
PG9-	AL	86.001	86.022	100	86.501	100	86.521	10	86.740	10
PG11-	AL	86.002	86.023	100	86.502	50	86.522	10	86.741	10
PG13.5-	AL	86.003	86.024	100	86.503	50	86.523	10	86.742	10
PG16-	AL	86.004	86.025	50	86.504	50	86.524	5	86.743	5
PG21-	AL	86.005	86.026	50	86.505	50	86.525	5	86.744	5
PG29-	AL	86.006	86.027	25	86.506	25	86.526	2	86.745	2
PG36-	AL	86.007	86.028	10	86.507	10	86.527	2	86.746	2
PG42-	AL	86.008	86.029	5	86.508	5	—	—	—	—
PG48-	AL	86.009	86.030	5	86.509	5	—	—	—	—
NPT3/8-	AL	86.061	86.081	50	86.541	50	—	—	—	—
NPT1/2-	AL	86.062	86.082	50	86.542	50	—	—	—	—
NPT3/4-	AL	86.063	86.083	25	86.543	25	—	—	—	—

Color, Example: Light Gray [LG] or Black [BK] or Brass, Nickel Plated [-] or Stainless Steel [-]  
Material, Example: Polyamide [PA] or Brass, Nickel Plated [BN] or Stainless Steel [SS]

## Dimensions

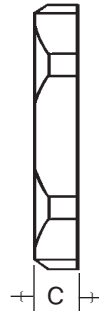
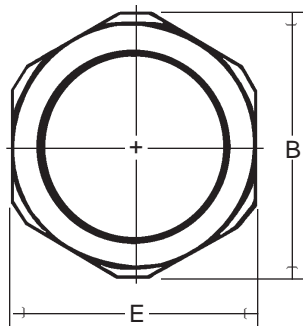

**E = Width Across Flats (mm.)**  
**B = Width Across "Tips"**  
**C = Thickness**

Most Locknuts (Front View)

Most Locknuts (Side View)

EMI / RFI Locknuts (Side View)

Locknut Material	Polyamide (PA)			Brass, Ni Plated (BN)			Stainless Steel (SS)			EMI / RFI Brass, Ni Plated (BN)		
	E	B	C	E	B	C	E	B	C	E	B	C
PG7	19.0	21.0 (.83)	5.0 (.20)	15.0	16.6 (.65)	2.8 (.11)	17.0	21.1 (.83)	3.0 (.12)	—	—	—
PG9	22.0	24.0 (.94)	5.0 (.20)	18.0	20.0 (.79)	2.8 (.11)	19.0	21.1 (.83)	3.0 (.12)	17.0	18.5 (.73)	6.0 (.24)
PG11	24.0	26.0 (1.02)	5.0 (.20)	21.0	23.5 (.93)	3.0 (.19)	22.0	22.3 (.88)	3.0 (.12)	22.0	24.4 (.96)	6.0 (.24)
PG13.5	27.0	29.0 (1.14)	6.0 (.24)	23.0	25.5 (1.00)	3.0 (.19)	24.0	26.8 (1.05)	3.0 (.12)	24.0	26.7 (1.05)	6.0 (.24)
PG16	30.0	33.0 (1.30)	6.0 (.24)	26.0	29.0 (1.14)	3.0 (.19)	27.0	30.2 (1.19)	3.0 (.12)	26.0	28.8 (1.13)	6.0 (.24)
PG21	36.0	39.0 (1.54)	7.0 (.28)	32.0	35.5 (1.40)	3.5 (.14)	32.0	35.8 (1.41)	3.5 (.14)	35.0	38.5 (1.52)	7.0 (.28)
PG29	46.0	50.0 (1.97)	7.0 (.28)	41.0	45.0 (1.77)	4.0 (.16)	41.0	45.7 (1.80)	4.0 (.16)	40.0	43.5 (1.71)	7.0 (.28)
PG36	60.0	66.0 (2.60)	8.0 (.32)	51.0	56.0 (2.20)	5.0 (.20)	50.0	55.8 (2.19)	5.0 (.20)	50.0	54.0 (2.13)	7.0 (.28)
PG42	65.0	73.0 (2.87)	8.0 (.32)	60.0	65.0 (2.56)	5.0 (.20)	—	—	—	—	—	—
PG48	70.0	78.0 (3.07)	8.0 (.32)	64.0	69.0 (2.72)	5.5 (.22)	—	—	—	—	—	—
NPT3/8"	22.0	24.0 (.94)	5.0 (.20)	17.0	—	3.0 (.19)	—	—	—	—	—	—
NPT1/2"	27.0	29.0 (1.14)	6.0 (.24)	24.0	—	3.0 (.19)	—	—	—	—	—	—
NPT3/4"	36.0	39.0 (1.54)	7.0 (.28)	30.0	—	3.5 (.14)	—	—	—	—	—	—



## INSTALLATION WORKSHEET FOR HIGH DENSITY APPLICATIONS

High density installation of Cord Grips is called for whenever a large number of cables or cords must be installed into an Enclosure, or the Enclosure is relatively small and a larger one can not be used.

By following some basic guidelines, multiple Cord Grips, even different sizes and materials, can be installed into a small area.

Before starting the layout, please make sure that the mechanical integrity of the Enclosure is not compromised. Also, make sure that the Locknuts and Cord Grips can be turned for fastening and that there is no interference with corners, walls and bottoms of the Enclosure or with installed items such as Mounting Plates, DIN Rails or other components.

In order to use Socket Wrenches (refer to page 53) or other tools to tighten the Cord Grips and Locknuts, a minimum clearance of "Y" (please see table below) must be maintained between the "tips" of the Cord Grips or Locknuts and Enclosure walls, bottoms, covers, etc. The same clearance must also be maintained (please see table below) between the "tips" of adjacent Cord Grips and/or Locknuts.

To help you determine the clearance required we provided the instructions and dimensional tables below:



### Instructions:

Determine the B dimensions for adjacent Strain Reliefs and Locknuts from the tables below. Please note that either the B dimension of the Strain Relief or the Locknut of any combination may be larger. Use the largest of both for the calculations outlined in the example below to determine X, the spacing between the centers of adjacent Mounting Holes.

Example: B1, a PG16 Polyamide (PA) High Performance Cord Grip has to be installed by using a PG16 Polyamide (PA) Locknut next to B2, a PG21 Polyamide (PA) Cord Grip with a PG21 Brass, Nickel Plated (BN) Locknut.

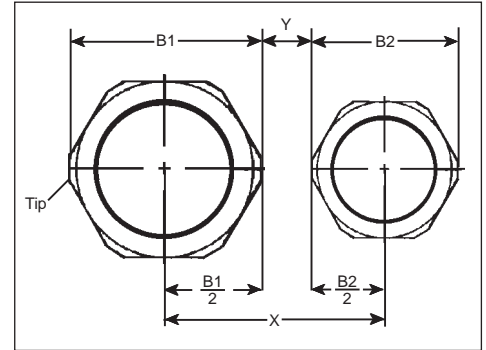

A) PG16 Polyamide (PA) Cord Grip: B = 30mm (1.18 in.)  
 PG16 Polyamide (PA) Locknut: B = 33mm (1.30 in.)  
 Result: The Locknut is larger, it's B dimension should be used for B1.

B) PG21 Polyamide (PA) Cord Grip: = 36.6mm (1.44 in.)  
 PG21 Brass, Nickel Plated (BN) Locknut = 35.5mm (1.40 in.)  
 Result: In this case the Cord Grip B dimension is larger and should be used for B2.

### Mathematical Spread

$$\text{Millimeters: } X = \frac{B1 + B2}{2} + Y \text{ mm} = \frac{33 + 36.6}{2} + 4.0 = 38.8 \text{ millimeters}$$

$$\text{Inches: } X = \frac{B1 + B2}{2} + Y \text{ in.} = \frac{1.3 + 1.44}{2} + .16 = 1.53 \text{ inches}$$

Thus, the minimum distance X between the center points of the Mounting Holes should be the 38.8 millimeters or 1.53 inches.

Repeat this calculation as many times as required. If Cord Grips are installed into Nonthreaded Holes use the "B" dimension of the Cord Grip, as no Locknuts are used.

If you prefer, prepare a drawing, showing the useable space available and draw circles with 1/2 the largest B dimension of any Cord Grip / Locknut combination, again maintaining the clearance of "Y" between the "tips" and "tips" to walls, bottoms, etc.

Type	Y mm (in.)	Type	Y mm (in.)
SW14	3.0 (.12)	SW32	4.0 (.16)
SW15	3.0 (.12)	SW33	4.0 (.16)
SW17	3.0 (.12)	SW35	4.5 (.18)
SW18	3.5 (.14)	SW40	5.0 (.20)
SW19	3.5 (.14)	SW41	5.0 (.20)
SW20	3.0 (.12)	SW43	5.0 (.20)
SW21	3.0 (.12)	SW50	5.5 (.22)
SW22	3.0 (.12)	SW51	5.5 (.22)
SW23	3.5 (.14)	SW53	6.0 (.24)
SW24	3.5 (.14)	SW57	6.5 (.26)
SW26	4.0 (.16)	SW54	7.0 (.28)
SW27	4.0 (.16)	SW65	7.5 (.30)
SW30	4.0 (.16)	SW70	8.0 (.31)

### Cord Grip "B" Dimension (width across tips) Product Group and Body Material

Locknut Material	Locknut "B" Dimension (width across tips)				Standard			High Performance			Economy	
	Polyamide (PA)	Brass, Ni Plated (BN)	Stainless Steel (SS)	EMI/RFI (BN)	Polyamide (PA)	Brass, Ni Plated (BN)	Polyamide (PA) PVDF (PO)	Brass, (BN) Stainless (SS)	EMI/RFI (BN)	Polystyrene (PS)	Brass, Ni Plated (BN)	
PG7	21.0 (.83)	16.6 (.65)	21.1 (.83)	—	16.5 (.69)	15.5 (.61)	16.2 (.64)	15.5 (.61)	—	16.0 (.63)	15.5 (.61)	
PG9	24.0 (.94)	20.0 (.79)	21.1 (.83)	18.5 (.73)	21.0 (.83)	18.9 (.74)	21.0 (.83)	18.9 (.74)	26.7(1.05)	20.5 (.81)	18.9 (.74)	
PG11	26.0(1.02)	23.5 (.93)	22.3 (.88)	24.4 (.96)	24.5 (.96)	22.2 (.87)	24.5 (.96)	22.2 (.87)	26.7(1.05)	24.0 (.94)	22.2 (.87)	
PG13.5	29.0(1.14)	25.5(1.00)	26.8(1.06)	26.7 (1.05)	26.6(1.05)	24.5 (.96)	26.5 (1.04)	24.5 (.96)	26.7(1.05)	26.0(1.02)	24.4 (.96)	
PG16	33.0(1.30)	29.0(1.14)	30.2(1.19)	28.8 (1.13)	30.0(1.18)	26.7(1.05)	29.5 (1.16)	26.7(1.05)	33.5(1.32)	29.0 (1.14)	26.5(1.04)	
PG21	39.0(1.54)	35.5(1.40)	35.8(1.41)	38.5 (1.52)	36.6(1.44)	33.5(1.32)	36.5 (1.44)	33.5(1.32)	33.5(1.32)	35.5 (1.40)	33.5(1.32)	
PG29	50.0(1.97)	45.0(1.77)	45.7(1.80)	43.5 (1.71)	46.3(1.82)	43.5(1.71)	46.0 (1.81)	43.5(1.71)	43.5(1.71)	45.5 (1.79)	44.0(1.73)	
PG36	66.0(2.60)	56.0(2.20)	55.8(2.20)	54.0 (2.13)	58.0(2.28)	54.0(2.13)	57.0 (2.24)	54.0(2.13)	54.0(2.13)	57.0 (2.24)	54.0(2.13)	
PG42	73.0(2.87)	65.0(2.56)	—	—	66.0(2.60)	61.0(2.40)	64.0 (2.52)	61.0(2.40)	65.0(2.56)	65.0(2.56)	61.0(2.40)	
PG48	78.0(3.07)	69.0(2.72)	—	—	71.0(2.80)	69.0(2.72)	70.0 (2.76)	69.0(2.72)	—	70.0 (2.76)	69.0(2.72)	
NPT3/8"	24.0 (.94)	—	—	—	24.3 (.93)	19.0 (.75)	24.4 (.96)	—	—	—	—	
NPT1/2"	29.0(1.14)	—	—	—	29.6 (1.17)	26.7(1.05)	26.7 (1.05)	—	—	—	—	
NPT3/4"	36.0(1.42)	—	—	—	36.1 (1.42)	33.5(1.32)	36.5(1.44)	—	—	—	—	

# COMMONLY USED METRIC AND OTHER USEFUL CONVERSIONS

<b>Length</b> inch [in.]      x25.4      =millimeters millimeters [mm]      x0.03937      =inches meters [m]      x3.281      =feet miles [mi]      x1.609      =kilometers kilometers [km]      x0.6214      =miles  <b>Torque</b> Newtonmeter [Nm]      x0.738      =lb-ft lb-ft      x1.356      =Nm lb-in      x0.113      =Nm oz-in      x0.0071      =Nm  <b>Power</b> kilowatt [kW]      x1.341      =hp hp      x0.7457      =kW  <b>Moment of Inertia (WR<sup>2</sup>)</b> lb-ft <sup>2</sup> x0.042      =kgm <sup>2</sup> kilogrammeter <sup>2</sup> 23.720      =lb-ft <sup>2</sup> [kgm <sup>2</sup> ]  <b>Weight Mass and Force</b> Newton [N]      x0.02248      =pound kilogram [kg]      x2.205      =pounds pound [lb]      x4.448      =N pound [lb]      x0.4536      =kg	Metric Cross-Sectional Areas <sup>1</sup>		American Wire Gauge		Metric Cross-Sections Areas <sup>a</sup>		American Wire Gauge	
	Cross-Sectional Area mm <sup>2</sup>	Equivalent Metric Area mm <sup>2</sup>	AWG or MCM	Cross-Sectional Area mm <sup>2</sup>	Equivalent Metric Area mm <sup>2</sup>	AWG or MCM		
0.50	0.519	20 AWG	25.0	21.15	4 AWG			
0.75	0.653	19	26.67	3				
	0.823	18	35.0	33.63	2			
				42.41	1			
1.5	1.04	17	50.0	53.48	1/0			
	1.31	16		67.43	2/0			
2.5	1.65	15	70.0	85.03	3/0			
	2.08	14	95.0					
	2.62	13		107.20	4/0			
4.0	3.31	12	120.0	126.64	250 MCM			
	4.17	11	150.0	152.00	300			
	5.26	10	185.0	177.35	350			
6.0				202.71	400			
	6.63	9	240.0	253.35	500			
	8.37	8	300.0					
10.0			400.0	380.00	750			
	10.55	7						
	13.30	6	500.0	506.71	1000			
16.0	16.77	5	625.0					

<sup>a</sup>As per IEC Publ. 228

## DEGREES CELSIUS VERSUS DEGREES FAHRENHEIT

°C	°F	°C	°F	°C	°F	°C	°F	°C	°F	°C	°F	°C	°F	°C	°F
-80	-112.0	-20	-4.0	5	41.0	30	86.0	55	131.0	80	176.0	105	221.0	130	266.0
-70	-94.0	-19	-2.2	6	42.8	31	87.8	56	132.8	81	177.8	106	222.8	131	267.8
-60	-65.0	-18	-0.4	7	44.6	32	89.6	57	134.6	82	179.6	107	224.6	132	269.6
-50	-58.0	-17	+1.4	8	46.4	33	91.4	58	136.4	83	181.4	108	226.4	133	271.4
-45	-49.1	-16	3.2	9	48.2	34	93.2	59	138.2	84	183.2	109	228.2	134	273.2
-40	-40.0	-15	5.0	10	50.0	35	95.0	60	140.0	85	185.0	110	230.0	135	275.0
-39	-38.2	-14	6.8	11	51.8	36	96.8	61	141.8	86	186.8	111	231.8	136	276.8
-38	-36.4	-13	8.6	12	53.6	37	98.6	62	143.6	87	188.6	112	233.6	137	278.6
-37	-34.6	-12	10.4	13	55.4	38	100.4	63	145.4	88	189.4	113	235.4	138	280.4
-36	-32.8	-11	12.2	14	57.2	39	102.2	64	147.2	89	192.2	114	237.2	139	282.2
-35	-31.0	-10	14.0	15	59.0	40	104.0	65	149.0	90	194.0	115	239.0	140	284.0
-34	-29.2	-9	15.8	16	60.8	41	105.8	66	150.8	91	195.8	116	240.8	141	285.8
-33	-27.4	-8	17.6	17	62.6	42	107.6	67	152.6	92	197.6	117	242.6	142	287.6
-32	-25.6	-7	19.4	18	64.4	43	109.4	68	154.4	93	199.4	118	244.4	143	289.4
-31	-23.8	-6	21.2	19	66.2	44	111.2	69	156.2	94	201.2	119	246.2	144	291.2
-30	-22.0	-5	23.0	20	68.0	45	113.0	70	158.0	95	203.0	120	248.0	145	293.0
-29	-22.0	-4	24.8	21	69.8	46	114.8	71	159.8	96	204.8	121	249.8	146	294.8
-28	-18.4	-3	26.6	22	71.6	47	116.6	72	161.6	97	206.6	122	251.6	147	296.6
-27	-16.6	-2	28.4	23	73.4	48	118.4	73	163.4	98	208.4	123	253.4	148	298.4
-26	-14.8	-1	30.2	24	75.2	49	120.2	74	165.2	99	210.2	124	255.2	149	300.2
-25	-13.0	0	32.0	25	77.0	50	122.0	75	167.0	100	212.0	125	257.0	150	302.0
-24	-11.2	1	33.8	26	78.8	51	123.8	76	168.8	101	213.8	126	258.8	160	320.0
-23	-9.4	2	35.6	27	80.6	52	125.6	77	170.6	102	215.6	127	260.6	170	338.0
-22	-7.6	3	37.4	28	82.4	53	127.4	78	172.4	103	217.4	128	262.4	180	356.0
-21	-5.8	4	39.2	29	84.2	54	129.2	79	174.2	104	219.2	129	264.2	190	374.0

Conversion Formula °F = 9/5°C + 32°

°C = 5/9(°F-32°)

# Fax Back

## Thank You

We hope this catalog has helped you in your selection of Liquid Tight Strain Reliefs. To learn more about other Altech products, please complete this form and fax it to us.

Name \_\_\_\_\_ Title \_\_\_\_\_

Company \_\_\_\_\_ Div./MS \_\_\_\_\_

Address \_\_\_\_\_

City \_\_\_\_\_ State \_\_\_\_\_ Zip \_\_\_\_\_

Phone (    ) \_\_\_\_\_ Fax (    ) \_\_\_\_\_

Please contact me to discuss my application.

Our product(s) are exported.  Yes  No

### My company is best classified as a(n):

- |  |   |
|--|---|
| <input type="checkbox"/> OEM               | <input type="checkbox"/> Systems Integrator |
| <input type="checkbox"/> End User/MRO      | <input type="checkbox"/> Distributor        |
| <input type="checkbox"/> Contractor        | <input type="checkbox"/> Consultant         |
| <input type="checkbox"/> Government/School | <input type="checkbox"/> Other _____        |

### My primary job function is:

- |   |  |
|---|--|
| <input type="checkbox"/> Product Design                   | <input type="checkbox"/> Sales/Marketing |
| <input type="checkbox"/> System Design                    | <input type="checkbox"/> Purchasing      |
| <input type="checkbox"/> Plant Operations/<br>Maintenance | <input type="checkbox"/> Other _____     |

### In my job, I

- |                                    |                                    |
|------------------------------------|------------------------------------|
| <input type="checkbox"/> Specify   | <input type="checkbox"/> Authorize |
| <input type="checkbox"/> Recommend | <input type="checkbox"/> Purchase  |

### Which best describes the end-product produced by your firm?

- |  |   |
|--|---|
| <input type="checkbox"/> Controls & Instrumentation      | <input type="checkbox"/> Electrical Machinery & Equipment |
| <input type="checkbox"/> Electronic Systems & Components | <input type="checkbox"/> Specialty Machinery & Equipment  |
| <input type="checkbox"/> Transportation Equipment        | <input type="checkbox"/> Other _____                      |

### Which industry(ies) does your company serve? (Please check all that apply)

- |  |   |   |  |  |
|--|---|---|--|--|
| <input type="checkbox"/> Aerospace         | <input type="checkbox"/> Automatic Vending  | <input type="checkbox"/> Agricultural       | <input type="checkbox"/> Automotive          | <input type="checkbox"/> Chemical Processing |
| <input type="checkbox"/> Commercial        | <input type="checkbox"/> Construction       | <input type="checkbox"/> Dairy              | <input type="checkbox"/> Defense/Military    | <input type="checkbox"/> Food Processing     |
| <input type="checkbox"/> Industrial & HVAC | <input type="checkbox"/> Industrial Process | <input type="checkbox"/> Machine Tool       | <input type="checkbox"/> Material Handling   | <input type="checkbox"/> Medical & Dental    |
| <input type="checkbox"/> Metalworking      | <input type="checkbox"/> Furnaces & Ovens   | <input type="checkbox"/> Mining             | <input type="checkbox"/> Oil & Gas Field     | <input type="checkbox"/> Packaging           |
| <input type="checkbox"/> Petrochemical     | <input type="checkbox"/> Pharmaceutical     | <input type="checkbox"/> Power Distribution | <input type="checkbox"/> Primary Metals      | <input type="checkbox"/> Printing & Textiles |
| <input type="checkbox"/> Pulp & Paper      | <input type="checkbox"/> Processing         | <input type="checkbox"/> Producing          | <input type="checkbox"/> Specialty Chemicals | <input type="checkbox"/> Textile             |

### Please rush literature on products circled below:

#### TERMINAL BLOCKS

- 311 DIN Rail
- 312 Mini DIN Rail
- 313 Panel
- 314 Eurostrips
- 315 Busbar System
- 316 Ceramic
- 317 PCB - Fixed
- 318 PCB - Pluggable

#### CIRCUIT BREAKERS

- 341 Miniature
- 342 Motor Controllers
- 343 Earth Leakage
- 344 Power Busbars

#### SENSORS

- 411 Inductive Proximity
- 412 Capacitive Proximity
- 413 Photoelectric Proximity
- 414 Ultrasonic Proximity
- 415 Magnetic Proximity
- 416 Liquid Level Controls

#### OTHER

- 261 Foot Switches
- 251 Disconnect Switches
- 231 European Fuses
- 239 Power Semiconductors
- 271 Safety Devices
- 279 Timers, Monitoring  
Sensing Devices

#### ENCLOSURE PRODUCTS

- 371 Industrial
- 391 Electronic
- 381 DIN
- 361 Strain Reliefs

#### INTERFACES

- 319 Interface Modules



Компания «ЭлектроПласт» предлагает заключение долгосрочных отношений при поставках импортных электронных компонентов на взаимовыгодных условиях!

Наши преимущества:

- Оперативные поставки широкого спектра электронных компонентов отечественного и импортного производства напрямую от производителей и с крупнейших мировых складов;
- Поставка более 17-ти миллионов наименований электронных компонентов;
- Поставка сложных, дефицитных, либо снятых с производства позиций;
- Оперативные сроки поставки под заказ (от 5 рабочих дней);
- Экспресс доставка в любую точку России;
- Техническая поддержка проекта, помощь в подборе аналогов, поставка прототипов;
- Система менеджмента качества сертифицирована по Международному стандарту ISO 9001;
- Лицензия ФСБ на осуществление работ с использованием сведений, составляющих государственную тайну;
- Поставка специализированных компонентов (Xilinx, Altera, Analog Devices, Intersil, Interpoint, Microsemi, Aeroflex, Peregrine, Syfer, Eurofarad, Texas Instrument, Miteq, Cobham, E2V, MA-COM, Hittite, Mini-Circuits, General Dynamics и др.);

Помимо этого, одним из направлений компании «ЭлектроПласт» является направление «Источники питания». Мы предлагаем Вам помощь Конструкторского отдела:

- Подбор оптимального решения, техническое обоснование при выборе компонента;
- Подбор аналогов;
- Консультации по применению компонента;
- Поставка образцов и прототипов;
- Техническая поддержка проекта;
- Защита от снятия компонента с производства.



#### Как с нами связаться

**Телефон:** 8 (812) 309 58 32 (многоканальный)

**Факс:** 8 (812) 320-02-42

**Электронная почта:** [org@eplast1.ru](mailto:org@eplast1.ru)

**Адрес:** 198099, г. Санкт-Петербург, ул. Калинина, дом 2, корпус 4, литера А.