

# AXL E EIP DI8 DO4 2A M12 6M

**Axioline E EtherNet/IP™ device,  
metal housing, 8 inputs, 4 outputs, 24 V DC,  
M12 fast connection technology**



Data sheet  
8423\_en\_02

© PHOENIX CONTACT 2015-09-24

## 1 Description

The Axioline E device is designed for use within an EtherNet/IP™ network.

It is used to acquire and output digital signals.

The device is designed for use in systems manufacturing.

It is suitable for use without a control cabinet under harsh industrial conditions.

The Axioline E device can be used on tool platforms, directly on welding robots or in conveying technology, for example.

### EtherNet/IP™ features

- 2 Ethernet ports (with integrated switch)
- Minimum cycle time of 1 ms (RPI)
- Supported protocols: ACD, DLR, IGMP v2, SNMP v1, HTTP, TFTP, FTP, BootP, DHCP
- Specification: CIP Edition 3.11; EIP adaptation of CIP 1.12
- Device description using EDS file
- Firmware can be updated
- Integrated web server for web-based management

### Axioline E features

- Connection to EtherNet/IP™ network using M12 connectors (D-coded)
- Transmission speed of 10 Mbps and 100 Mbps
- Connection of digital sensors and actuators to M12 connectors (A-coded)
- Diagnostic and status indicators
- Short-circuit and overload protection of the sensor supply
- IP65/67 degree of protection



This data sheet is only valid in association with the associated user manual.



Make sure you always use the latest documentation.  
It can be downloaded from the product at [phoenixcontact.net/products](http://phoenixcontact.net/products).

<b>2</b>	<b>Table of contents</b>	
1	Description .....	1
2	Table of contents .....	2
3	Ordering data .....	3
4	Technical data .....	4
5	Internal circuit diagram .....	7
6	Pin assignment .....	8
7	Connection example.....	10
8	Connection notes .....	10
9	Configuration via rotary encoding switch .....	11
10	Local status and diagnostic indicators .....	13
11	Monitoring.....	15
12	Substitute value behavior .....	15
13	EtherNet/IP™ object classes, messages, and services.....	16
14	EtherNet/IP™ Assembly instances.....	25
15	Startup.....	27
16	SNMP - Simple Network Management Protocol .....	28
17	DLR - Device Level Ring.....	28
18	WBM - Web-based management .....	28
19	Firmware update.....	28
20	Quick Connect.....	28
21	Connection types.....	28
22	Device description (EDS) .....	28

### 3 Ordering data

Description	Type	Order No.	Pcs. / Pkt.
Axioline E EtherNet/IP™ device in a metal housing with 8 digital inputs and 4 digital outputs, each with a load capacity of 2 A, 24 V DC, M12 fast connection technology	AXL E EIP DI8 DO4 2A M12 6M	2701490	1

Accessories	Type	Order No.	Pcs./Pkt.
An M12 screw plug for the unoccupied M12 sockets of the sensor/actuator cable, boxes and flush-type connectors (Protection and sealing elements)	PROT-M12	1680539	5
Mounting plate for Axioline E metal devices (Assembly)	AXL E MP 60	2701761	1
Snap-in markers, Sheet, white, unlabeled, can be labeled with: THERMOMARK CARD, BLUEMARK CLED, BLUEMARK LED, TOPMARK LASER, Mounting type: snapped into marker carrier, Lettering field: 7 x 10 mm (Marking)	UCT-EM (7X10)	0830765	10

Documentation	Type	Order No.	Pcs. / Pkt.
User manual, English, Axioline E: system and installation	UM EN AXL E SYS INST	-	-
Application note, English: Updating the firmware of AXL E devices using the Windows Explorer	AH EN FIRMWARE UPDATE AXL E	-	-

#### Additional ordering data

For additional accessories, visit [phoenixcontact.net/products](http://phoenixcontact.net/products).

## 4 Technical data

### Dimensions (nominal sizes in mm)

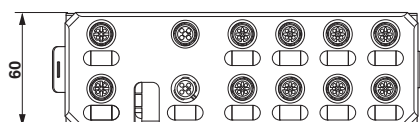
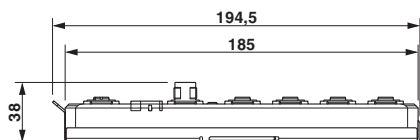

Width	60 mm
Height	185 mm
Depth	38 mm

Note on dimensions

The height is 194.5 mm including the mounting plate. With fixing clips pulled out, the height is 212 mm. The depth is 38 mm including the mounting plate (30.5 mm without the mounting plate).

### General data

Housing material	Zinc die-cast
Weight	750 g
Ambient temperature (operation)	-25 °C ... 60 °C



**CAUTION: Risk of burns**

If the device is used at an ambient temperature above 50°C, the contact temperature of metal surfaces may exceed 70°C.

Ambient temperature (storage/transport)	-25 °C ... 85 °C
Permissible humidity (operation)	5 % ... 95 %
Permissible humidity (storage/transport)	5 % ... 95 %
Air pressure (operation)	80 kPa ... 108 kPa (up to 3000 m above sea level)
Air pressure (storage/transport)	70 kPa ... 106 kPa (up to 3000 m above sea level)
Degree of protection	IP65/67
Protection class	III, IEC 61140, EN 61140, VDE 0140-1

### Connection data

Connection method	M12 connector
-------------------	---------------

### Interface EtherNet/IP™

Number	2
Connection method	M12 connectors, D-coded
Designation connection point	Copper cable
Number of positions	4
Transmission speed	10/100 MBit/s (with auto negotiation)
Cycle Time	min. 1 ms (RPI)

<b>EtherNet/IP™</b>	
Equipment type	EtherNet/IP™ slave
EtherNet/IP™ protocols	ACD, DLR, IGMP v2
Additional protocols	SNMP v1, HTTP, TFTP, FTP, BootP, DHCP
Specification	CIP Edition 3.11 EIP adaptation of CIP 1.12

<b>Supply: Module electronics and sensors (U<sub>S</sub>)</b>	
Connection method	M12 connector (T-coded)
Number of positions	4
Supply voltage	24 V DC
Nominal supply voltage range	18 V DC ... 31.2 V DC (including all tolerances, including ripple)
Typical current consumption	140 mA ±15 % (at 24 V DC)
Current consumption	max. 12 A

<b>Supply: Actuators (U<sub>A</sub>)</b>	
Connection method	M12 connector (T-coded)
Number of positions	4
Supply voltage	24 V DC
Nominal supply voltage range	18 V DC ... 31.2 V DC (including all tolerances, including ripple)
Typical current consumption	30 mA ±15 % (at 24 V DC)
Current consumption	max. 12 A

<b>Digital inputs</b>	
Number of inputs	8 (EN 61131-2 types 1 and 3)
Connection method	M12 connector, double occupancy
Connection method	2, 3, 4-wire
Nominal input voltage	24 V DC
Nominal input current	typ. 3 mA
Sensor current per channel	typ. 0.75 mA (from U <sub>S</sub> )
Total sensor current	max. 0.6 A (per device)
Input voltage range "0" signal	-30 V DC ... 5 V DC
Input voltage range "1" signal	11 V DC ... 30 V DC
Input filter time	< 1000 µs
Permissible conductor length to the sensor	30 m
Overload protection, short-circuit protection of sensor supply	Yes

<b>Digital outputs</b>	
Number of outputs	4
Connection method	M12 connector, (A-coded)
Connection method	2, 3-wire
Nominal output voltage	24 V DC (from voltage U <sub>A</sub> )
Maximum output current per channel	2 A
Nominal load, ohmic	12 W (48 Ω; with nominal voltage)
Nominal load, inductive	12 VA (1.2 H; 48 Ω; with nominal voltage)
Signal delay	max. 150 µs (when switched on)
Signal delay	max. 200 µs (when switched off)
Switching frequency	max. 5500 per second (with at least 50 mA load current)
Switching frequency	max. 1 per second (with inductive load)

### Digital outputs

Limitation of the voltage induced on circuit interruption	-28 V ... -17 V
Output voltage when switched off	max. 1 V
Output current when switched off	max. 20 µA
Behavior with overload	Auto restart
Reverse voltage resistance to short pulses	Reverse voltage proof
Overcurrent shut-down	min. 2.2 A
Overload protection, short-circuit protection of outputs	Electronic

### Electrical isolation/isolation of the voltage areas

Test section	Test voltage
24 V supply (communications power and sensor supply, digital inputs)/ bus connection (Ethernet 1)	500 V AC, 50 Hz, 1 min
24 V supply (communications power and sensor supply, digital inputs)/ bus connection (Ethernet 2)	500 V AC, 50 Hz, 1 min
24 V supply (communications power and sensor supply, digital inputs)/FE	500 V AC, 50 Hz, 1 min
Bus connection (Ethernet 1)/FE	500 V AC, 50 Hz, 1 min
Bus connection (Ethernet 2)/FE	500 V AC, 50 Hz, 1 min
Bus connection (Ethernet 1)/bus connection (Ethernet 2)	500 V AC, 50 Hz, 1 min
24 V supply (actuator supply, digital outputs)/24 V supply (communications power and sensor supply, digital inputs)	500 V AC, 50 Hz, 1 min
24 V supply (actuator supply, digital outputs)/bus connection (Ethernet 1)	500 V AC, 50 Hz, 1 min
24 V supply (actuator supply, digital outputs)/bus connection (Ethernet 2)	500 V AC, 50 Hz, 1 min
24 V supply (actuator supply, digital outputs)/FE	500 V AC, 50 Hz, 1 min

### Mechanical tests

Vibration resistance in acc. with EN 60068-2-6/IEC 60068-2-6	5 g
Shock in acc. with EN 60068-2-27/IEC 60068-2-27	30 g, 11 ms period, half-sine shock pulse
Continuous shock according to EN 60068-2-27/IEC 60068-2-27	10 g

### Conformance with EMC Directive 2004/108/EC

#### Noise immunity test in accordance with EN 61000-6-2

Electrostatic discharge (ESD) EN 61000-4-2/IEC 61000-4-2	Criterion B; 6 kV contact discharge, 8 kV air discharge
Electromagnetic fields EN 61000-4-3/IEC 61000-4-3	Criterion A; Field intensity: 10 V/m
Fast transients (burst) EN 61000-4-4/IEC 61000-4-4	Criterion B, 2 kV
Transient surge voltage (surge) EN 61000-4-5/IEC 61000-4-5	Criterion B; DC supply lines: ±0.5 kV/±0.5 kV (symmetrical/asymmetrical)
Conducted interference EN 61000-4-6/IEC 61000-4-6	Criterion A; Test voltage 10 V

#### Noise emission test as per EN 61000-6-4

Radio interference properties EN 55022	Class A
--	---------

### Approvals

For the latest approvals, please visit [phoenixcontact.net/products](http://phoenixcontact.net/products).

### 5 Internal circuit diagram

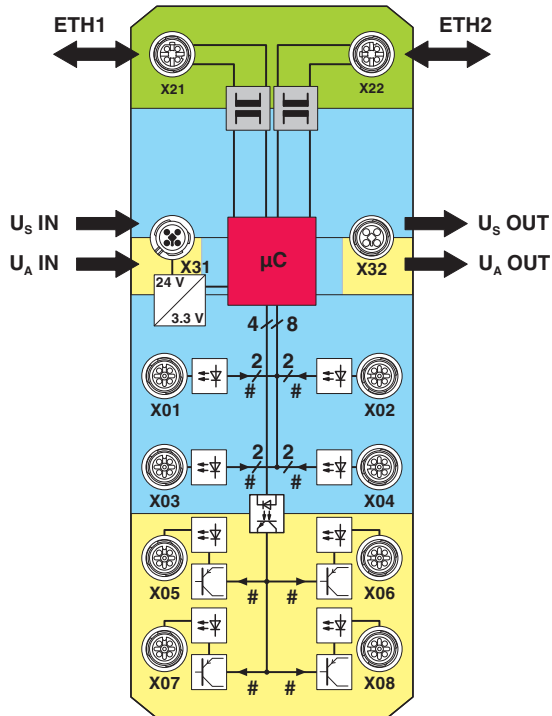

Key:

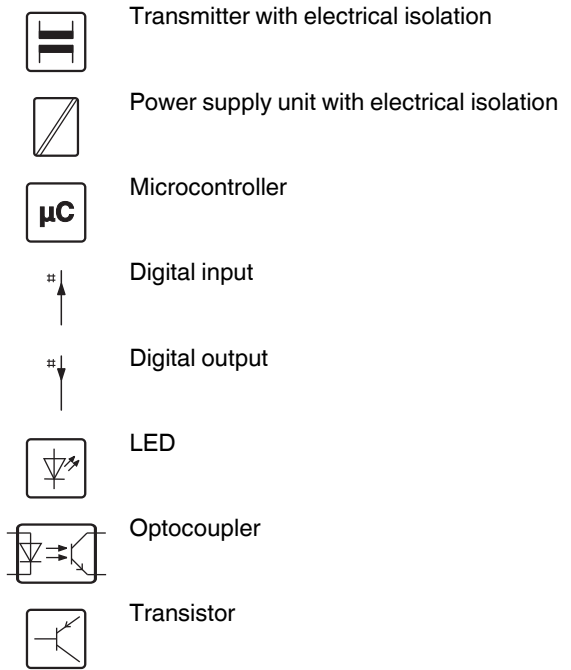

Figure 1 Internal wiring of connections

Key:

Green area: Network  
 Blue area:  $U_S$   
 Yellow area:  $U_A$

## 6 Pin assignment

### 6.1 Ethernet and power supply connection

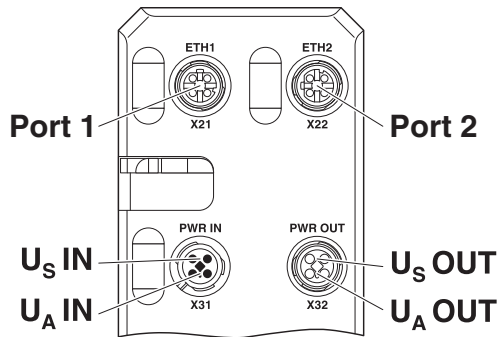

Figure 2 Connections for EtherNet/IP™ and voltage supply

Designation	Meaning
Port 1 (X21)	Ethernet port 1
Port 2 (X22)	Ethernet port 2
U <sub>S</sub> IN (X31)	Power supply IN (logic and sensors)
U <sub>A</sub> IN (X31)	Power supply IN (actuators)
U <sub>S</sub> OUT (X32)	Power supply OUT for additional devices
U <sub>A</sub> OUT (X32)	Power supply OUT for additional devices



Ground the device by means of the mounting screws of the fixing clips or the mounting plate or the DIN rail.

### 6.2 EtherNet/IP™ pin assignment



Figure 3 Ethernet pin assignment, D-coded

Pin	Ethernet port 1 (X21)	Ethernet port 2 (X22)
1	TX+	TX+
2	RX+	RX+
3	TX-	TX-
4	RX-	RX-



The shield is connected to FE in the device.



The thread is used for additional shielding.

### 6.3 Pin assignment of the power supply U<sub>S</sub>/U<sub>A</sub>



Figure 4 Pin assignment of the power supply, T-coded

Pin	IN	OUT	Conductor colors
1	+24 V DC (U <sub>S</sub> )	+24 V DC (U <sub>S</sub> )	Brown
2	GND (U <sub>A</sub> )	GND (U <sub>A</sub> )	White
3	GND (U <sub>S</sub> )	GND (U <sub>S</sub> )	Blue
4	+24 V DC (U <sub>A</sub> )	+24 V DC (U <sub>A</sub> )	Black



6.4 Connecting inputs and outputs



Figure 5 Input and output connections

Designation	Meaning
DI1 ... DI8 (X01 ... X04)	Inputs 1 ... 8
DO1 ... DO4 (X05 ... X08)	Outputs 1 ... 4

6.5 Pin assignment of the inputs and outputs



Figure 6 Pin assignment of the inputs and outputs, A-coded

Pin	Input socket	Output socket
1	+24 V DC ( $U_S$ )	Not used
2	Input 2, 4, 6, 8	Not used
3	GND	GND
4	Input 1, 3, 5, 7	Output 1, 2, 3, 4
5	FE	FE

## 7 Connection example



Figure 7 Example of connection of sensors and actuators

## 8 Connection notes



**Note: data corruption or loss**

Implement the FE connection using mounting screws, in order to ensure immunity to interference.



**NOTE: device damage**

To ensure IP65/IP67 protection, cover unused sockets with protective caps.



**NOTE: Damage to the electronics**

Only supply the sensors with the voltage  $U_S$  provided at the terminal points.



**NOTE: Damage to the electronics**

Observe the correct polarity of the supply voltages  $U_S$  and  $U_A$  in order to prevent damage to the device.



**NOTE: Malfunction**

When connecting the sensors and actuators, observe the assignment of the connections to the EtherNet/IP™ input and output data.



Secure the device to a level surface or to a profile. Do not use this device to bridge gaps, in order to prevent forces being transmitted via the device.



Use standard M5 screws with toothed lock washer and self-locking nuts. Observe the maximum torque of the screws.

## 9 Configuration via rotary encoding switch

You can configure the address assignment and other functions using rotary encoding switches.

After modifying the switch position, restart the device, as the modification to the switch position does not take effect during operation.

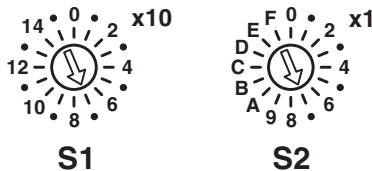

Figure 8 Rotary encoding switch

The code results from the sum of S1 x 10 plus S2 x 1. The image shows code 77 (7 x 10 + 7).

S1	S2	Code	Function
0	0	00	Remote access (default)
0 ... 5	1 ... 0	01 ... 50	Manual address assignment
5 ... 15	0 ... 9	51 ... 159	DHCP name assignment
0	A	0A	Fixed address
0	E	0E	Resetting IP parameters
0	F	0F	Resetting to the default settings
Other			Reserved

### 9.1 Remote access

#### Switch position 00

At this switch position, it is possible to remotely configure the device using corresponding tools (e.g., Startup+, web-based management (WBM)).

#### Behavior during initial startup, after resetting the IP parameters or after resetting to default settings

A valid IP address is not assigned (0.0.0.0) and communication is therefore not possible.

The device transmits continuous BootP requests (2 s, 4 s, 8 s, 2 s ...), until a valid IP address has been received.

Valid IP parameters are then automatically saved as configuration data on the device.

#### Each additional startup

If BootP is not explicitly deactivated, the device transmits continuous BootP requests (2 s, 4 s, 8 s, 2 s, etc.), until a valid IP address has been received.

Valid IP parameters are then automatically saved as configuration data on the device.

### 9.2 Manual address assignment

#### Switch position 01 ... 50

##### Default: BootP deactivated, DHCP activated

The first three octets in the IP address are preset as 192.168.0.x.

The subnet mask is 255.255.255.0.

Specify the last byte with the switch position.

As such, you can select IP addresses between 192.168.0.1 and 192.168.0.50.

Prior to transferring the IP address, a test is performed to check for any potential IP address conflicts. If a conflict is detected, the device temporarily switches the IP address to 0.0.0.0 (no IP communication). In this case, the NET LED flashes red. Eliminate the conflict and restart the device.

### 9.3 DHCP name assignment

#### Switch position 51 ... 159

This switch position is used to easily specify the DHCP host name for the device.

The host name is provided to the DHCP server via DHCP options. This is therefore able to send a DNS update to the DNS server.

The DNS name consists of one set part, which is based on the order designation, and a variable part, which is determined by the switch position.

The first part of the station name is AXL-E-EIP-.

The set number is added.

This results in the following station names: AXL-E-EIP-051 ... AXL-E-EIP-159.

#### Behavior during initial startup, after resetting the IP parameters or after resetting to default settings

A valid IP address is not assigned (0.0.0.0) and communication is therefore not possible.

The device transmits continuous DHCP discover messages until a valid IP address has been received.

### Each additional startup

The device transmits continuous DHCP requests.

There are two possible scenarios:

1. The DHCP server assigns a new IP address.  
⇒ The device applies the new IP parameters.
2. The DHCP server does not respond.  
⇒ The device transmits continuous DHCP Discover messages until new IP parameters have been received.

### 9.4 Fixed address

#### Switch position 0A

#### Behavior during initial startup, after resetting the IP parameters or after resetting to default settings

A valid IP address is not assigned (0.0.0.0) and communication is therefore not possible.

Assign an address initially with another switch position.

#### Each additional startup

After a voltage reset, the device maintains the IP address which was assigned last.



With this switch position, modifying the IP address via tools or web-based management is not possible.

### 9.5 Resetting IP parameters

#### Switch position 0E

The IP parameters stored on the device are reset.

All other settings made on the device are retained.

- BootP is activated for switch position 00.
- IP address, subnet mask: 0.0.0.0

As long as the switch position 0E remains selected, no connection to the device can be established.

IP communication is deactivated (LED NET static yellow).

### 9.6 Resetting to the default settings

#### Switch position 0F

All settings are reset to default settings, including IP parameters.



The device is ready for operation after powering up, as soon as the RDY LED lights up green.

A connection to the device however cannot be established in this switch position.

As soon as the RDY LED lights up green, a new switch position can be selected on the rotary encoding switch and the device can be restarted.

### 9.7 Reserved/invalid switch position

The device starts with the previous settings, e.g., with the settings that were valid before the device was restarted.

An invalid switch position is indicated by the RDY LED (red on).

## 10 Local status and diagnostic indicators

### 10.1 Indicators for Ethernet ports and power supply

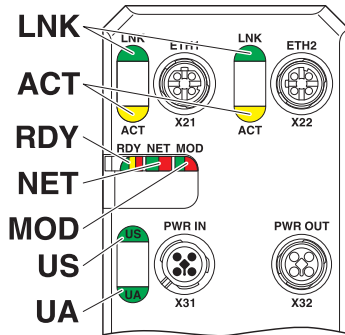

Figure 9 Indicators for Ethernet ports and power supply

Designation	Color	Meaning	State	Description
LNK 1/2	Green	<b>Link</b>	Green ON	Connection present at port 1/2.
			OFF	Connection not present at port 1/2.
ACT 1/2	Yellow	<b>Activity</b>	Yellow ON	Data transmission present at port 1/2.
			OFF	Data transmission not present at port 1/2.
RDY	Green/ yellow/ red	<b>Ready</b>	Green ON	Device is ready for operation.
			Yellow flashing	Firmware update is being performed.
			Flashing green/ yellow	Over- or undervoltage at $U_S$
				Temperature of the device is in the critical area.
				Failure of the actuator supply $U_A$
				Surge voltage/undervoltage of the actuator supply $U_A$ And red US LED: sensor supply overload
			Red ON	Rotary encoding switches are set to an invalid/reserved position.
OFF	Device is not ready for operation.			
NET	Green/ red	<b>Network status</b>	Green ON	At least one CIP connection is in place and the exclusive owner connection has no timeout.
			Green flashing	An IP address is configured, no CIP connection is yet in place, and the exclusive owner connection has no timeout.
			Red ON	Duplicate IP. ACD has determined an IP address conflict.
			Red flashing	Connection timeout. A timeout of an exclusive owner connection has occurred.
			Flashing green/ red	Self test
			OFF	Device is not ready for operation.

Designation	Color	Meaning	State	Description
MOD	Green/ red	<b>Module status</b>	Green ON	Normal operation
			Green flashing	The device is not configured.
			Red ON	A recoverable error has occurred.
			Red flashing	A unrecoverable error has occurred.
			Flashing green/ red	Self test
			OFF	Device is not ready for operation.
US	Green/ red	U <sub>Sensorik</sub>	Green ON	Communications power/sensor voltage present
			OFF	Communications power/sensor voltage not present or too low.
			Red ON	Sensor voltage overload
UA	Green	U <sub>Aktorik</sub>	ON	Actuator voltage present.
			OFF	Actuator voltage not present.

### 10.2 Input and output indicators

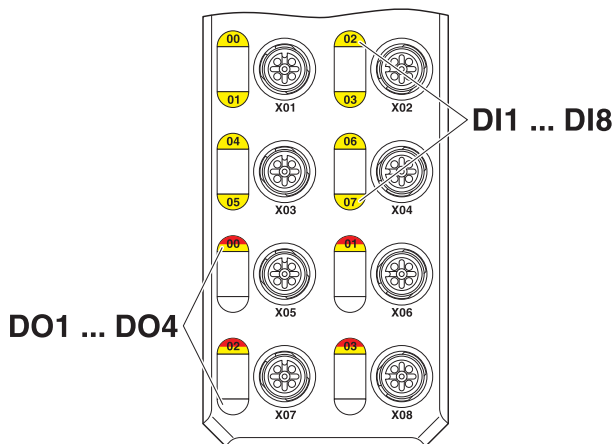

Figure 10 Input and output indicators

Designation	Color	Meaning	State	Description
00 ... 07	Yellow	Status of the inputs	ON	Input is set.
			OFF	Input is not set.
00 ... 03	Yellow/red	Status of the outputs	Yellow ON	Output is set.
			Red ON	Output is short circuited or overloaded.
			OFF	Output is not set.



The numbering of the LEDs is as follows: the first number specifies the byte, the second number specifies the bit.

## 11 Monitoring

The connection monitoring is configured through a timeout multiplier by the EtherNet/IP™ scanner.

If a connection timeout occurs, all the outputs are set to a safe state by the device itself

The Ethernet communication is monitored as follows:

Mechanism	Monitoring
Connection monitoring for the scanner	Client application
	Ethernet connection

## 12 Substitute value behavior

The substitute value can be set through the Assembly instance 102.

### 13 EtherNet/IP™ object classes, messages, and services

The device supports the Common Industrial Protocol (CIP) by using digital input points (DIPs) and digital output points (DOPs) according to the ODVA specification. EtherNet/IP™ uses the Common Industrial Protocol (CIP) as the application layer. IP and TCP or UDP are used for the network and transport layers. CIP and EtherNet/IP™ are standardized by the ODVA on a manufacturer-neutral basis. The Common Industrial Protocol is an object-oriented protocol with two different types of communication between a controller and termination devices.

The following table describes the two communication types.

Connection type	Description
Explicit messaging	This means that a controller or an engineering system sends a request and the termination device responds. For example, explicit messaging can be used for configuration and/or diagnostics.
Implicit messaging	Implicit messaging is used for the cyclic transmission of I/O data. That means, for example, that a termination device sends an analog value which is present at a termination device input. The time for a transmission cycle can be set via the requested packet interval (RPI).

#### 13.1 CIP class services

The device supports the following class services and instance services:

Service code		Service name
dec	hex	
01	01	Get_Attribute_All
02	02	Set_Attribute_All
05	05	Reset
09	09	Delete
14	0E	Get_Attribute_Single
16	10	Set_Attribute_Single

#### 13.2 CIP object classes

The device supports the following CIP object classes:

Class code		Object type
dec	hex	
01	01	Identity object
04	04	Assembly object
06	06	Connection manager object
08	08	Digital input point (DIP) object
09	09	Digital output point (DOP) object
71	47	Device level ring object
72	48	Quality of service object
245	F5	TCP/IP interface object
246	F6	Ethernet link object



### 13.3 Identity object (class code 01<sub>hex</sub>)

The Identity object is required by all devices and provides the device ID and general information about the device.

#### Class attributes

Attribute	Name	Access	Data type	Value
1	Version	Get	UINT	1
2	Max instance	Get	UINT	1
6	Max class attribute	Get	UINT	7
7	Max instance attribute	Get	UINT	9

#### Instance attributes

Attribute	Name	Access	Data type	Value	
1	Vendor ID	Get	UINT	562	
2	Device type	Get	UINT	General purpose discrete I/O	
3	Product code	Get	UINT	8174	
4	Revision	Get	STRUC of:	1	
	Major revision		USINT	1	
	Minor revision		USINT	1	
5	Status	Get	WORD	Bit 0	Owned
				Bit 1	Reserved
				Bit 2	Configured
				Bit 3	Reserved
				Bit 4 ... Bit 7	Extended device status
				Bit 8	Minor recoverable fault
				Bit 9	Minor unrecoverable fault
				Bit 10	Major recoverable fault
				Bit 11	Major unrecoverable fault
	Bit 12 ... Bit 15	Extended device status 2			
6	Serial number	Get	UDINT	Is fixed in production process	
7	Product name	Get	STRING	AXL E EIP DI8 DO4 M12 6M	
8	State	Get	USINT	0 = Nonexistent	
				1 = Device self testing	
				2 = Standby	
				3 = Operational	
				4 = Major recoverable fault	
				5 = Major unrecoverable fault	
				6 ... 254 = Reserved	
255 = Default for Get_Attribute_All service					
9	Configuration consistency value	Get	USINT	CRC checksum	

**Common services**

Service code		Class	Instance	Service name
dec	hex			
01	01	Yes	Yes	Get_Attribute_All
05	05	No	Yes	Reset
14	0E	Yes	Yes	Get_Attribute_Single
16	10	No	Yes	Set_Attribute_Single

**13.4 Assembly object (class code 4<sub>hex</sub>)**

The Assembly object combines attributes of multiple objects to allow data to or from each object to be sent or received via a single connection.

**Class attributes**

Attribute	Name	Access	Data type	Value
1	Version	Get	UINT	2
2	Max instance	Get	UINT	102

**Instance attributes**

Attribute	Name	Access	Data type	Description
3	Data	Get, Set	ARRAY of Byte	Current Process data of the correspondent Assembly instance
4	Size	Get	UINT	Number of bytes in attribute 3

**Common services**

Service code		Class	Instance	Service name
dec	hex			
14	0E	Yes	Yes	Get_Attribute_Single
16	10	No	Yes	Set_Attribute_Single

**13.5 Connection manager object (class code 06<sub>hex</sub>)**

**Class attributes**

Attribute	Name	Access	Data type	Value
1	Version	Get	UINT	1
2	Max instance	Get	UINT	1

### 13.6 Discrete Input Point object (class code 08<sub>hex</sub>)

The Digital input point (DIP) object mirrors the digital inputs. This object can be used in simple toggle switches as well as in complex I/O control modules. Each device has a separate instance for each digital input.

#### Class attributes

Attribute	Name	Access	Data type	Value
1	Version	Get	UINT	2

#### Instance attributes

Attribute	Name	Access	Data type	Value
3	Value	Get	BOOL	0 = off; 1 = on
4	Status	Get	BOOL	0 = OK; 1 = error

#### Common services

Service code		Class	Instance	Service name
dec	hex			
14	0E	Yes	Yes	Get_Attribute_Single
16	10	No	Yes	Set_Attribute_Single

### 13.7 Discrete Output Point object (class code 09<sub>hex</sub>)

The Digital output point (DOP) object is used to map digital outputs. You can use this object in simple applications (actuator) or in complex applications (digital I/O control device). Each device has a separate instance for each digital output.

#### Class attributes

Attribute	Name	Access	Data type	Value
1	Version	Get	UINT	1

#### Instance attributes

Attribute	Name	Access	Data type	Value
3	Value	Get, Set	BOOL	0 = off; 1 = on
4	Status	Get	BOOL	0 = OK; 1 = Fault

#### Common services

Service code		Class	Instance	Service name
dec	hex			
14	0E	Yes	Yes	Get_Attribute_Single
16	10	No	Yes	Set_Attribute_Single

13.8 Device level ring object (class code 47<sub>hex</sub>)

Class attributes

Attribute	Name	Access	Data type	Value
1	Version	Get	UINT	2

Instance attributes

Attribute	Name	Access	Datentyp	Wert/ Beschreibung	
1	Network topology	Get	USINT	0 = Linear 1 = Ring	
2	Network status	Get	USINT	0 = Normal 1 = Ring fault 2 = Unexpected loop detected 3 = Partial network fault 4 = Rapid fault/Restore cycle	
10	Active supervisor address	Get	STRUCT of:	IP and/or MAC address of the active ring supervisor	
			UDINT	Supervisor IP address	
			ARRAY of 6 USINTs	Supervisor MAC address	
12	Capability flags	Get	DWORD	Bit 0	Announced-based ring node
				Bit 1	Beacon-based ring note
				Bit 2 ... Bit 4	Reserved
				Bit 5	Supervisor capable
				Bit 6 ... Bit 31	Reserved

Common services

Service code		Class	Instance	Service name
dec	hex			
1	01	Yes	Yes	Get_Attribute_Single
14	0E	Yes	Yes	Set_Attribute_Single

**13.9 Quality of service object (class code 48<sub>hex</sub>)**

Quality of Service (QoS) affects the forwarding and handling of data streams and results in individual data streams being given differential treatment (usually preferential). QoS can be used, e.g., to guarantee a transmission bandwidth for individual data streams. The device uses QoS in connection with prioritization.

**Class attributes**

Attribute	Name	Access	Data type	Value
1	Version	Get	UINT	1
2	Max instance	Get	UINT	1

**Instance attributes**

Attribute	Name	Access	Data type	Value/Description
1	802.1Q tag enable	Get, Set	UINT	0 = off (default); 1 = on
4	DSCP urgent	Get, Set	USINT	DSCP value for CIP transport class 0/1 Urgent priority message (default 55)
5	DSCP scheduled	Get, Set	USINT	DSCP value for CIP transport class 0/1 Scheduled priority message (default 47)
6	DSCP high	Get, Set	USINT	DSCP value for CIP transport class 0/1 High priority message (default 43)
7	DSCP low	Get, Set	USINT	DSCP value for CIP transport class 0/1 Low priority message (default 31)
8	DSCP explicit	Get, Set	USINT	DSCP value for CIP explicit messages (transport class 2/3 and UCMM) and all other EtherNet/IP encapsulation messages (default 27)

**Common services**

Service code		Class	Instance	Service name
dec	hex			
14	0E	Yes	Yes	Get_Attribute_Single
16	10	No	Yes	Set_Attribute_Single

13.10 TCP/IP object (class code F5<sub>hex</sub>)

Class attributes

Attribute	Name	Access	Data type	Value
1	Version	Get	UINT	3
2	Max instance	Get	UINT	1

Instance attributes

Attribute	Name	Access	Data type	Description	
1	Status	Get	DWORD	Bit 0 ... Bit 3	Interface configuration status
				Bit 4	Mcast pending (always 0)
				Bit 5	Interface configuration pending
				Bit 6	AcadStatus
				Bit 7	AcadFault
				Bit 8 ... Bit 31	Reserved
2	Configuration capability	Get	DWORD	Bit 0	BOOTP client
				Bit 1	Not supported
				Bit 2	DHCP client
				Bit 3	Not supported
				Bit 4	TCP/IP config settable via ETH/IP
				Bit 5	Not supported
				Bit 6	Not supported
				Bit 7	AcadCapable
				Bit 8 ... Bit 31	Reserved
3	Configuration control	Get, Set	DWORD	Bit 0 ... Bit 3	0 = The device use static IP configuration 1 = The device use BOOTP 2 = The device use DHCP
				Bit 4	Not supported
				Bit 5 ... Bit 31	Reserved
4	Physical link object	Get	STRUCT of:	Path to Physical link object	
	Path size		UINT	4	
	Path		Padded EPATH	0x20, 0xF6, 0x25, 0x01	

Attribute	Name	Access	Data type	Description
5	Interface configuration	Get, Set	STRUCT of:	TCP/IP network interface configuration
	IP address		UDINT	The device's IP address
	Network mask		UDINT	The device's network mask
	Gateway address		UDINT	Default gateway address
	Name server		UDINT	Primary name server (always 0.0.0.0)
	Name server 2		UDINT	Secondary name server (always 0.0.0.0)
	Domain name		STRING	Default domain name (always empty)
6	Host name	Get, Set	STRING	The device's host name
10	SelectAcd	Get, Set	BOOL	0 = disable; 1 = enable (default)
11	Last conflict detected	Set	STRUCT of:	Structure containing information related to the last conflict detected
	AcdActivity		USINT	State of ACD activity when last conflict detected 0 = Noconflict detected (default) 1 = Probelpv4Address 2 = OngoingDetection 3 = SemiActiveProbe
	Remote MAC		ARRAY of 6 USINTs	MAC address of remote node from the ARP PDU in which a conflict was detected
	ArpPdu		Array of 28 USINTs	Copy of the raw ARP PDU in which a conflict was detected.
12	Ethernet/IP quick connect	Get, Set	BOOL	0 = disable (default); 1 = enable

**Common services**

Service code		Class	Instance	Service name
dec	hex			
1	01	Yes	Yes	Get_Attribute_All
14	0E	Yes	Yes	Get_Attribute_Single
16	10	No	Yes	Set_Attribute_Single

13.11 Ethernet link object (class code F6<sub>hex</sub>)

Class attributes

Attribute	Name	Access	Data type	Description
1	Version	Get	UINT	3
2	Max instance	Get	UINT	10
3	Number of instances	Get	UINT	2

Instance attributes

Attribute	Name	Access	Data type	Description	
1	Interface speed	Get	UDINT	Interface speed currently in use. Speed in bps (e.g. 10, 100)	
2	Interface flags	Get	DWORD	Bit 0	Link status
				Bit 1	Half/Full duplex status 0 = Half duplex; 1 = Full duplex
				Bit 2 ... Bit 4	Auto negotiation status 0 = Auto negotiation in progress 1 = Auto negotiation and speed detection failed 2 = Auto negotiation failed but detected speed 3 = Successfully negotiated 4 = Auto negotiation not attempted
				Bit 5	Not supported
				Bit 6	Not supported
3	Physical address	Get	ARRAY of 6 USINTs	MAC layer address	
6	Interface control	Set	STRUC of:	Configuration for physical interface	
	Control bits		WORD	Interface control bits	
			Bit 0	Auto-negotiate (set) 0 = Auto negotiation disabled 1 = Auto negotiation enabled	
			Bit 1	Forced duplex mode (set) 0 = Half duplex ; 1 = Full duplex Set only if auto negotiation is disabled	
Forced interface speed	UINT	The Forced interface speed bits indicate the speed at which the interface shall operate. 10 = 10 Mbps 100 = 100 Mbps Set only if auto negotiation is disabled			
10	Interface lable	Get	STRING	Interface name	

Common services

Service code		Class	Instance	Service name
dec	hex			
1	0E	Yes	Yes	Get_Attribute_All
14	10	No	Yes	Get_Attribute_Single



## 14 EtherNet/IP™ Assembly instances

	Exclusive owner	Input only	Listen only
Input data length in bytes	5	5	5
Assembly instance	101	101	101
Output data length in bytes	1	0	0
Assembly instance	100	193	192
Configuration data length in bytes	2	2	-
Assembly instance	102	102	-

### 14.1 Assembly instance 100 (OUT process data)

Byte	Function	Description
0	Output data	Output data channel 1 ... 8

Output process data								
Byte	Byte 0							
Bit	7	6	5	4	3	2	1	0
OUT	-	-	-	-	03	02	01	00
Connection	-	-	-	-	X08	X07	X06	X05
Pin	-	-	-	-	4	4	4	4
DO	-	-	-	-	4	3	2	1

Key:

- Bit: Process data assignment
- OUT: LED marking
- DO: Output of the device

14.2 Assembly instance 101 (IN process data)

Byte	Function	Description
0 ... 3	Status byte	Status information
4	Input data	Input data channel 1 ... 8

The first four bytes of the input data have the same format for all Axioline E versions.

Bit 31 ... bit 6	Bit 5	Bit 4	Bit 3	Bit 2	Bit 1	Bit 0
Reserved	Supply of the module electronics and sensors (U <sub>S</sub> )		Supply of the actuators (U <sub>A</sub> )		Outputs	
Reserved	Undervoltage	Overload	Undervoltage	Short-circuit	Overload	Short-circuit

Input process data								
Byte	Byte 0							
Bit	7	6	5	4	3	2	1	0
IN	07	06	05	04	03	02	01	00
Connection	X04		X03		X02		X01	
Pin	2	4	2	4	2	4	2	4
DI	8	7	6	5	4	3	2	1

Key:

Bit: Process data assignment

IN: LED marking

DI: Input of the device

14.3 Assembly instance 102 (configuration data)

Byte	Data type	Value range	Default value	Description
0	UINT8	0 ... 3	0	Substitute behavior
				0: set all values to "0"
				1: set all values to "1"
				2: hold last value
				3: set substitute values
1	UINT8	0 ... 255	0	Parameterizable substitute value, only used when the substitute value type is set to "Substitute values".

## 15 Startup

### 15.1 Delivery state/default settings

By default upon delivery, the following functions and features are available:

#### IP settings

IP parameters:	0.0.0.0
Subnet mask:	0.0.0.0
Default Gateway:	0.0.0.0
BootP:	activated

#### Firmware update

Firmware update on next re-start:	deactivated
TFTP server IP address:	192.168.210.211
Firmware file name:	FIRMWARE.NXF

#### System identification

Device name:	No name assigned
Description:	No description assigned
Device location:	No location assigned
Contact:	No contact assigned

#### Web-based Management (WBM)

User name:	admin
Password:	private

### 15.2 Restoring the default settings

There are two options for resetting the default settings:

- Via web-based management, go to the Administration web page > default settings and follow the instructions.
- Via the rotary coding switch, switch position 0F

### 15.3 Starting the firmware

Once you have connected the power, the firmware is started.

After completion of the firmware boot process, the NET LED either lights up or flashes green.

## 16 SNMP - Simple Network Management Protocol

The device supports SNMP v1.

### Management Information Base - MIB



The corresponding latest MIBs are available on the Internet at phoenixcontact.net/products.

For the object descriptions, please refer to the ASN1 descriptions for this product.

The password for read access is “public” and cannot be changed.

By default upon delivery, the password for write/read access is “private” and can be modified at any time.

## 17 DLR - Device Level Ring

The device supports DLR.

DLR is a protocol that works on Layer 2 for multi-port-EtherNet/IP™ devices.

The use of DLR is transparent for the protocols which work on higher levels such as TCP/IP.

DLR increases the network availability, thanks to a redundant ring topology with a switch-over time of less than 3 ms for error detection and reconfiguration.

The DLR protocol supports the 1-ring topology; multiple rings or overlapping rings are not possible.

## 18 WBM - Web-based management

The device has a web server, which generates the required pages for web-based management and, depending on the requirements of the user, sends them to a standard web browser. Web-based management can be used to access static information (e.g., technical data, MAC address) or dynamic information (e.g., IP address, status information).

### Calling web-based management

The device web server can be addressed using the IP address if configured accordingly. The homepage (web page) of the device is accessed by entering the URL “http://ip-address”.

Example: http://172.16.113.38

The default user name is “admin”, the default password is “private”.



If you cannot access the WBM pages, check the connection settings in your browser and deactivate the proxy, if set.

## 19 Firmware update

In order to update the firmware of the device, the device must be provided with a firmware container via a TFTP server or it must be loaded onto the device via FTP. Any FTP client or TFTP server can be used for this. The update must always be initiated by the web-based management. When carrying out the firmware update, the RDY LED flashes yellow.

## 20 Quick Connect

The device supports Quick Connect Class A.

After switching on the mains voltage, it is ready to operate in under 350 ms in order to process a connection request.

A cyclic process data connection can be established in under 500 ms.

## 21 Connection types

The device supports the connection types Exclusive Owner, Input Only, and Listen Only.

- Exclusive Owner and Input Only can be configured by the scanner as a Multicast or Point to Point connection in the Target to Originator direction.
- Listen Only connections can only be used as Multicast.

In the case of the AXL E Ethernet/IP™ device, the data is transmitted to the scanner with a connection.

## 22 Device description (EDS)

In the case of EtherNet/IP™, a device description file (EDS) is required for various configuration tools.

For each Axioline E EtherNet/IP™ device, an individual specific EDS file is provided.



Компания «ЭлектроПласт» предлагает заключение долгосрочных отношений при поставках импортных электронных компонентов на взаимовыгодных условиях!

Наши преимущества:

- Оперативные поставки широкого спектра электронных компонентов отечественного и импортного производства напрямую от производителей и с крупнейших мировых складов;
- Поставка более 17-ти миллионов наименований электронных компонентов;
- Поставка сложных, дефицитных, либо снятых с производства позиций;
- Оперативные сроки поставки под заказ (от 5 рабочих дней);
- Экспресс доставка в любую точку России;
- Техническая поддержка проекта, помощь в подборе аналогов, поставка прототипов;
- Система менеджмента качества сертифицирована по Международному стандарту ISO 9001;
- Лицензия ФСБ на осуществление работ с использованием сведений, составляющих государственную тайну;
- Поставка специализированных компонентов (Xilinx, Altera, Analog Devices, Intersil, Interpoint, Microsemi, Aeroflex, Peregrine, Syfer, Eurofarad, Texas Instrument, Miteq, Cobham, E2V, MA-COM, Hittite, Mini-Circuits, General Dynamics и др.);

Помимо этого, одним из направлений компании «ЭлектроПласт» является направление «Источники питания». Мы предлагаем Вам помощь Конструкторского отдела:

- Подбор оптимального решения, техническое обоснование при выборе компонента;
- Подбор аналогов;
- Консультации по применению компонента;
- Поставка образцов и прототипов;
- Техническая поддержка проекта;
- Защита от снятия компонента с производства.



#### Как с нами связаться

**Телефон:** 8 (812) 309 58 32 (многоканальный)

**Факс:** 8 (812) 320-02-42

**Электронная почта:** [org@eplast1.ru](mailto:org@eplast1.ru)

**Адрес:** 198099, г. Санкт-Петербург, ул. Калинина, дом 2, корпус 4, литера А.