

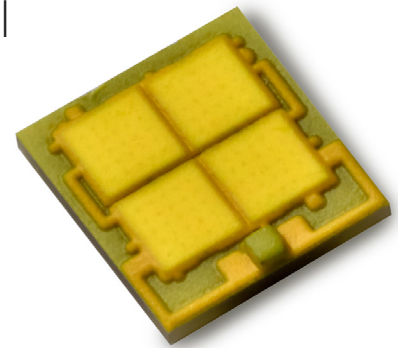

LUXEON MZ

Best combination of brightness, uniformity and luminance enabling precision light control

LUXEON MZ is an undomed multi-die LED designed to enable outdoor and industrial applications with all of the features of LUXEON M including the identical solder footprint, but allowing for tighter beam control and higher punch due to a smaller apparent source size. With *Freedom from Binning* and leading performance, LUXEON MZ falls within a single 3- or 5-step MacAdam ellipse centered in ANSI to ensure color consistency from LED to LED, delivering high efficacy and high flux density from a uniform source with tight correlated color temperature control. The superior quality of light, volume of lumens, and real world efficacy enable leading performance and efficient solution development in a wide variety of lighting segments.



FEATURES AND BENEFITS

- Undomed package for improved punch and exceptional luminance
- Common footprint as LUXEON M for compatibility with existing designs
- Industry leading 11.2V package delivers exceptional efficacy
- Leading thermal resistance enables flexible system design to optimize for lm/\$ and lm/W
- Exceeds ENERGY STAR® lumen maintenance requirements

PRIMARY APPLICATIONS

- Downlights
- High Bay & Low Bay
- Lamps
- Outdoor
- Spotlights

Table of Contents

General Product Information	2
Product Test Conditions	2
Part Number Nomenclature	2
Lumen Maintenance	2
Environmental Compliance	2
Performance Characteristics	3
Product Selection Guide	3
Electrical and Thermal Characteristics	4
Absolute Maximum Ratings	4
Characteristic Curves	5
Spectral Power Distribution Characteristics	5
Light Output Characteristics	7
Forward Current Characteristics	9
Radiation Patterns	11
Product Bin and Labeling Definitions	12
Decoding Product Bin Labeling	12
Luminous Flux Bins	13
Radiometric Power Bins	13
Color Bin Definition	14
Dominant Wavelength Bins	14
Forward Voltage Bins	15
Mechanical Dimensions	15
Reflow Soldering Guidelines	16
Solder Pad Design	17
Packaging Information	18
Pocket Tape Dimensions	18
Reel Dimensions	19

General Product Information

Product Test Conditions

LUXEON MZ LEDs are tested and binned with a drive current of 700mA for LUXEON MZ 12V, 1400mA for LUXEON MZ 6V and 2800mA for LUXEON M 3V at a junction temperature, T_j , of 85°C.

Part Number Nomenclature

Part numbers for LUXEON MZ follow the convention below:

L M Z **A - B C D D - E E E E**

Where:

- A** – designates minimum CRI (7=70, 8=80, 9=90CRI, 0=Royal Blue)
- B** – designates voltage (S=12V, R=6V, Q=3V)
- C** – designates color (W=White, R=Royal Blue)
- D D** – designates CCT (27=2700K, 30=3000K, 35=3500K, 40=4000K, 50=5000K, 57=5700K, 65=6500K, 00=Royal Blue)
- E E E E** – designates minimum flux lumen (optional)

Therefore, the following part number is used for a white LUXEON MZ 12V 3000K 80CRI:

L M Z **8 - S W 3 0 - x x x x**

Lumen Maintenance

Please contact your local Sales Representative or Lumileds Technical Solutions Manager for more information about the long-term performance of this product.

Environmental Compliance

Lumileds LLC is committed to providing environmentally friendly products to the solid-state lighting market. LUXEON MZ is compliant to the European Union directives on the restriction of hazardous substances in electronic equipment, namely the RoHS Directive 2011/65/EU and REACH Regulation (EC) 1907/2006. Lumileds LLC will not intentionally add the following restricted materials to its products: lead, mercury, cadmium, hexavalent chromium, polybrominated biphenyls (PBB) or polybrominated diphenyl ethers (PBDE).

Performance Characteristics

Product Selection Guide

Table 1a. Product performance of LUXEON MZ White at test current, $T_j=85^\circ\text{C}$.

VOLTAGE	NOMINAL CCT [2]	MINIMUM CRI	LUMINOUS FLUX [1] (lm)		TEST CURRENT (mA)	PART NUMBER
			MINIMUM	TYPICAL		
12V	3000K	70	805	840	700	LMZ7-SW30
	4000K	70	870	940	700	LMZ7-SW40
	5000K	70	870	950	700	LMZ7-SW50
	5700K	70	900	980	700	LMZ7-SW57
	6500K	70	900	980	700	LMZ7-SW65
	2700K	80	710	760	700	LMZ8-SW27
	3000K	80	730	781	700	LMZ8-SW30
	3500K	80	730	800	700	LMZ8-SW35
	4000K	80	840	880	700	LMZ8-SW40
	5000K	80	840	890	700	LMZ8-SW50
	2700K	90	560	600	700	LMZ9-SW27
	3000K	90	600	640	700	LMZ9-SW30
5700K	90	700	770	700	LMZ9-SW57	
6V	3000K	70	805	840	1400	LMZ7-RW30
	4000K	70	870	940	1400	LMZ7-RW40
	5000K	70	870	950	1400	LMZ7-RW50
	5700K	70	900	980	1400	LMZ7-RW57
	6500K	70	900	980	1400	LMZ7-RW65
	2700K	80	710	760	1400	LMZ8-RW27
	3000K	80	730	781	1400	LMZ8-RW30
	3500K	80	730	800	1400	LMZ8-RW35
	4000K	80	840	880	1400	LMZ8-RW40
	5000K	80	840	890	1400	LMZ8-RW50
	2700K	90	560	600	1400	LMZ9-RW27
	3000K	90	600	640	1400	LMZ9-RW30
5700K	90	700	770	1400	LMZ9-RW57	
3V	3000K	70	805	840	2800	LMZ7-QW30
	4000K	70	870	940	2800	LMZ7-QW40
	5000K	70	870	950	2800	LMZ7-QW50
	5700K	70	900	980	2800	LMZ7-QW57
	6500K	70	900	980	2800	LMZ7-QW65
	2700K	80	710	760	2800	LMZ8-QW27
	3000K	80	730	781	2800	LMZ8-QW30
	3500K	80	730	800	2800	LMZ8-QW35
	4000K	80	840	880	2800	LMZ8-QW40
	5000K	80	840	890	2800	LMZ8-QW50
	2700K	90	560	600	2800	LMZ9-QW27
	3000K	90	600	640	2800	LMZ9-QW30
5700K	90	700	770	2800	LMZ9-QW57	

Notes for Table 1:

1. Lumileds maintains a tolerance of ± 2 on CRI and $\pm 6.5\%$ on luminous flux measurements.
2. Typical CRI is approximately 2 points higher than the minimum CRI specified, but this is not guaranteed.

Table 1b. Product performance for LUXEON MZ Royal Blue at test current, $T_j=85^\circ\text{C}$.

VOLTAGE	NOMINAL CCT	RADIOMETRIC POWER (mW)		TYPICAL RADIANT EFFICACY (%)	TEST CURRENT (mA)	PART NUMBER
		MINIMUM	TYPICAL			
12V	Royal Blue	3500	3600	45.9	700	LMZ0-SR00
6V	Royal Blue	3500	3600	45.9	1400	LMZ0-RR00
3V	Royal Blue	3500	3600	45.9	2800	LMZ0-QR00

Notes for Table 1b:

1. Lumileds maintains a tolerance of $\pm 6.5\%$ on radiometric power measurements.

Optical Characteristics

Table 2. Optical characteristics for LUXEON MZ at test current, $T_j=85^\circ\text{C}$.

PART NUMBER	TYPICAL TOTAL INCLUDED ANGLE ^[1]	TYPICAL VIEWING ANGLE ^[2]
LMZx-xWxx	140°	120°

Notes for Table 2:

- Total angle at which 90% of total luminous flux is captured.
- Viewing angle is the off axis angle from the LED centerline where the luminous intensity is ½ of the peak value.

Electrical and Thermal Characteristics

Table 3. Electrical and thermal characteristics for LUXEON MZ at test current, $T_j=85^\circ\text{C}$.

PART NUMBER	FORWARD VOLTAGE (V) ^[1]			TYPICAL TEMPERATURE COEFFICIENT OF FORWARD VOLTAGE (mV/°C) ^[2]	TYPICAL THERMAL RESISTANCE - JUNCTION TO SOLDER PAD (°C/W)
	MINIMUM	TYPICAL	MAXIMUM		
LMZx-Sxxx	10.50	11.20	11.70	-7.00	1.25
LMZx-Rxxx	5.25	5.60	6.00	-3.50	1.25
LMZx-Qxxx	2.63	2.80	3.00	-1.75	1.25

Notes for Table 3:

- Lumileds maintains a tolerance of $\pm 0.06\text{V}$ on forward voltage measurements.
- Measured between 25°C and 85°C.

Absolute Maximum Ratings

Table 4. Absolute maximum ratings for LUXEON MZ.

PARAMETER	MAXIMUM PERFORMANCE
DC Forward Current ^[1,2]	1200mA for LMZx-Sxxx 2400mA for LMZx-Rxxx 4800mA for LMZx-Qxxx
Peak Pulsed Forward Current ^[1,3]	1375mA for LMZx-Sxxx 2750mA for LMZx-Rxxx 5500mA for LMZx-Qxxx
LED Junction Temperature ^[1] (DC & Pulse)	-40°C to 135°C
ESD Sensitivity (ANSI/ESDA/JEDEC JS-001-2012)	Class 3B
Operating Case Temperature ^[1]	-40°C to 120°C
Storage Temperature	-40°C to 120°C
Soldering Temperature	JEDEC 020c 260°C
Allowable Reflow Cycles	3
Reverse Voltage (V_{reverse})	LUXEON LEDs are not designed to be driven in reverse bias

Notes for Table 4:

- Proper current derating must be observed to maintain the junction temperature below the maximum allowable junction temperature.
- Residual periodic variations due to power conversion from alternating current (AC) to direct current (DC), also called "ripple," are acceptable if the following conditions are met:
 - The frequency of the ripple current is 100Hz or higher
 - The average current for each cycle does not exceed the maximum allowable DC forward current
 - The maximum amplitude of the ripple does not exceed 15% of the maximum allowable DC forward current
- At 10% duty cycle with pulse width of 10ms.

Characteristic Curves

Spectral Power Distribution Characteristics

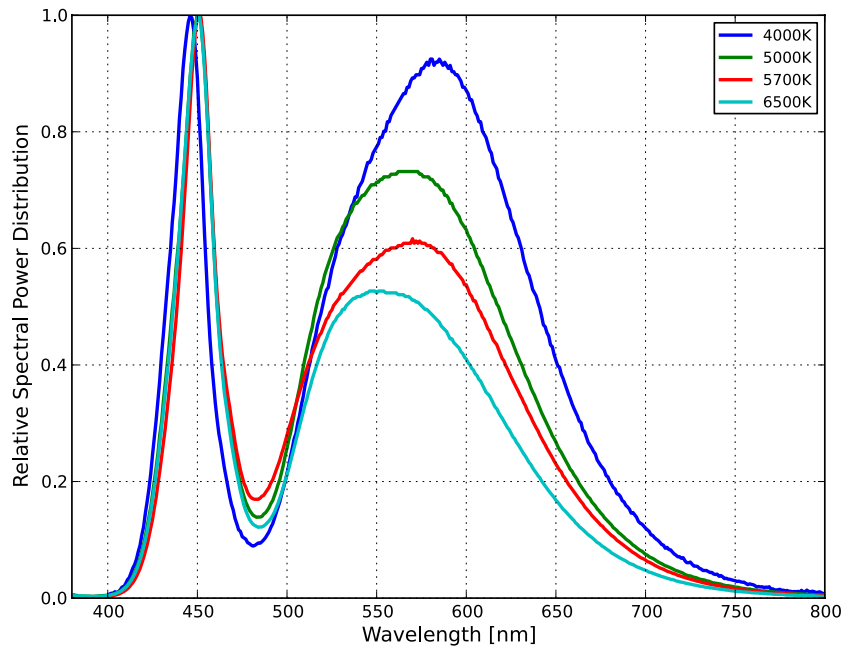

Figure 1a: Typical normalized power vs. wavelength for LMZ7-xWxx at specified test current, $T_j=85^\circ\text{C}$.

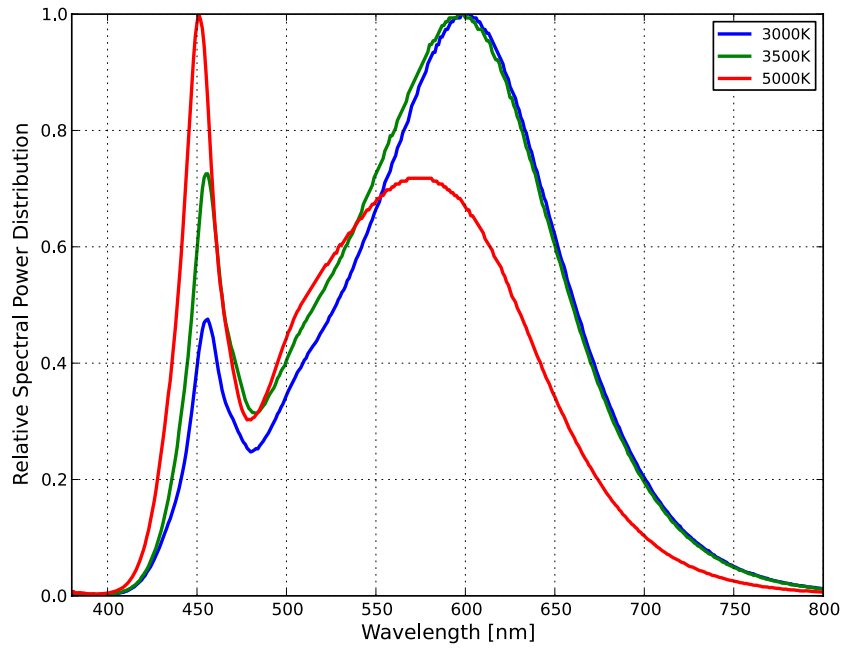

Figure 1b: Typical normalized power vs. wavelength for LMZ8-xWxx at specified test current, $T_j=85^\circ\text{C}$.

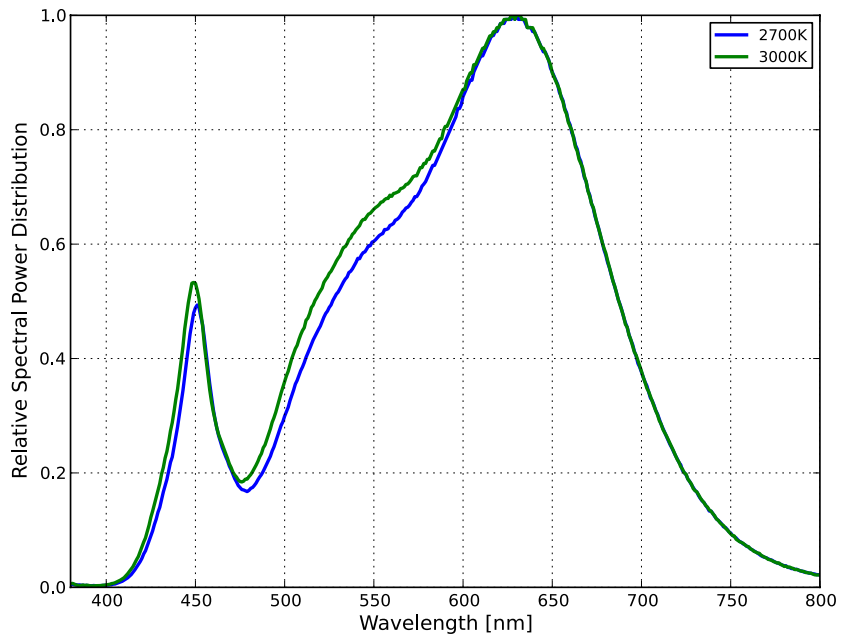

Figure 1c: Typical normalized power vs. wavelength for LMZ9-xWxx at specified test current, $T_j=85^\circ\text{C}$.



Figure 1d: Typical normalized power vs. wavelength for LMR0-xR00 at specified test current, $T_j=85^\circ\text{C}$.

Light Output Characteristics

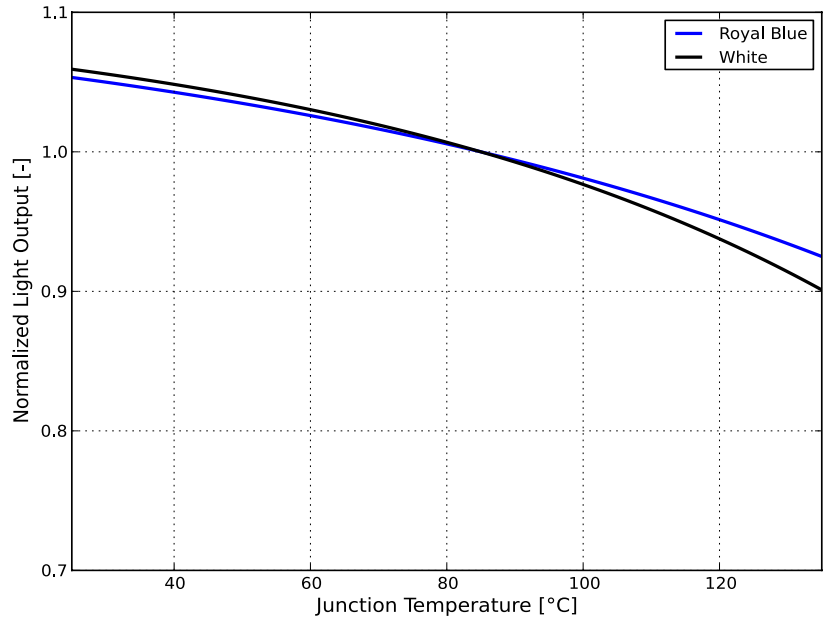

Figure 2: Typical normalized light output vs. junction temperature for LMZx-xxxx at specified test current.

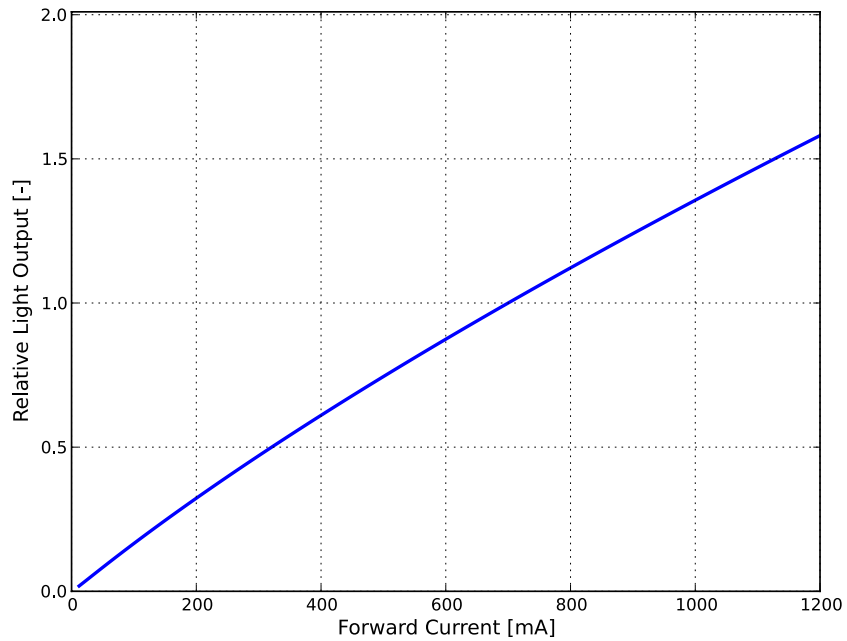

Figure 3a: Typical normalized light output vs. forward current for LMZx-Sxxx at $T_j=85^\circ\text{C}$.

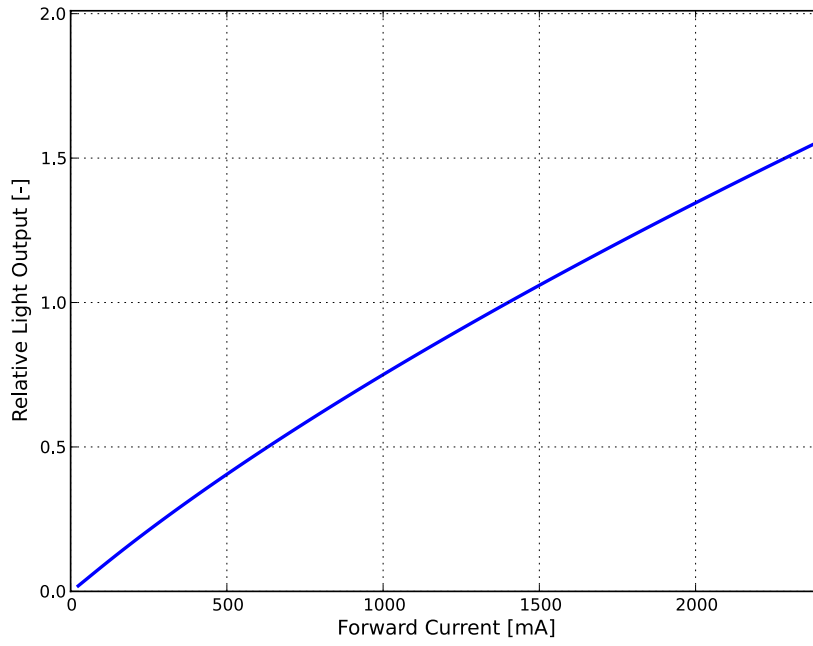

Figure 3b: Typical normalized light output vs. forward current for LMZx-Rxxx at T_j=85°C.

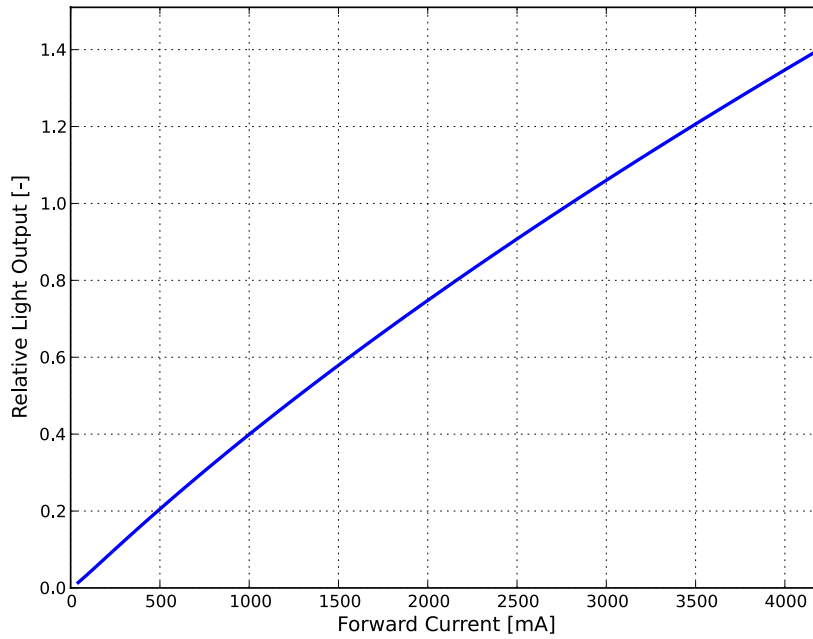

Figure 3c: Typical normalized light output vs. forward current for LMZx-Qxxx at T_j=85°C.

Forward Current Characteristics

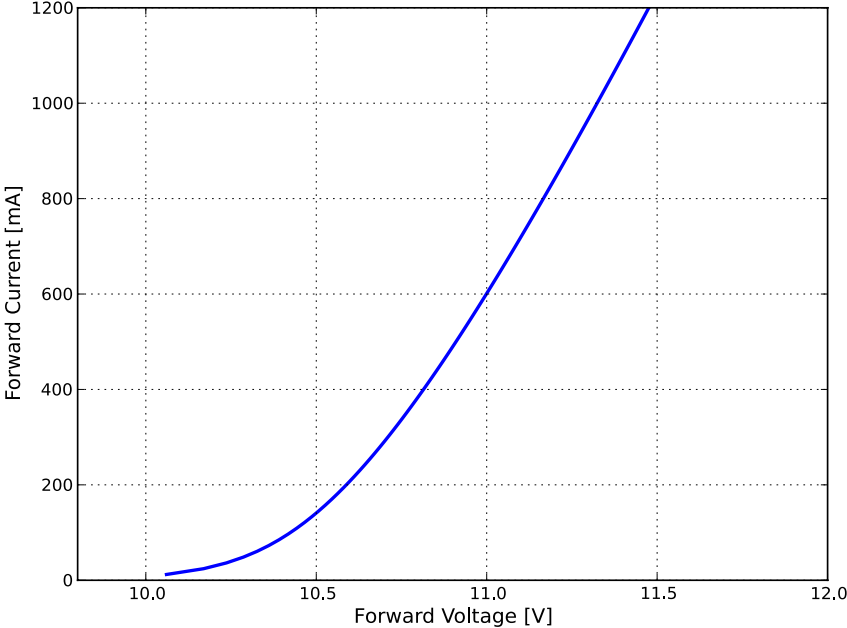

Figure 4a: Typical forward current vs. forward voltage for LMZx-Sxxx at $T_j=85^\circ\text{C}$.

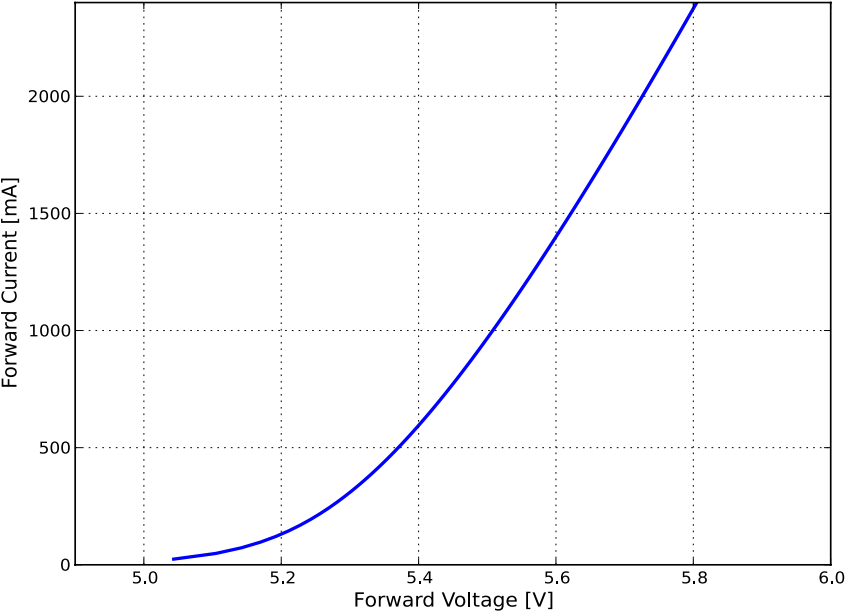

Figure 4b: Typical forward current vs. forward voltage for LMZx-Rxxx at $T_j=85^\circ\text{C}$.



Figure 4c: Typical forward current vs. forward voltage for LMZx-Qxxx at $T_j=85^\circ\text{C}$.

Radiation Patterns

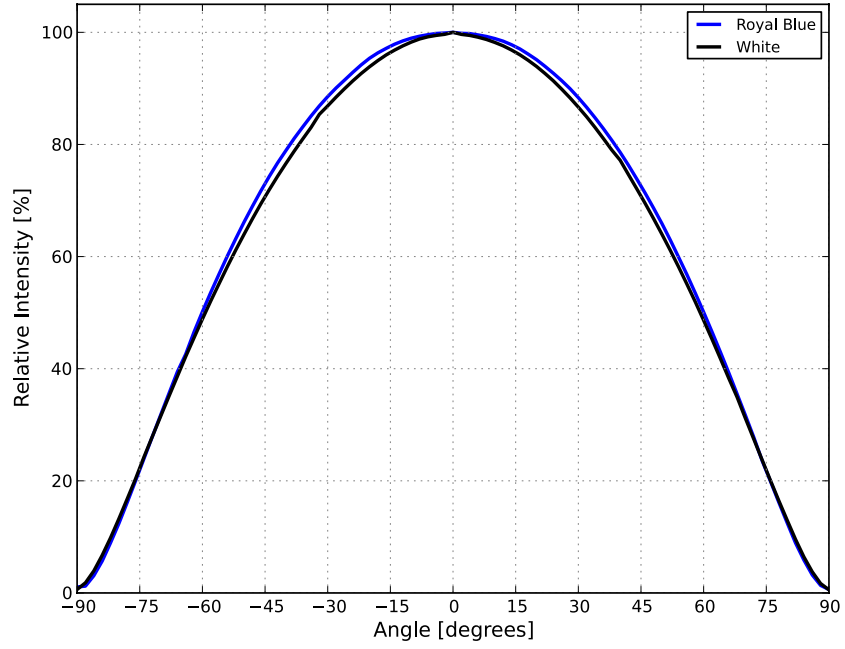

Figure 5: Typical radiation pattern for LMZx-xxxx at specified test current, $T_j=85^{\circ}\text{C}$.

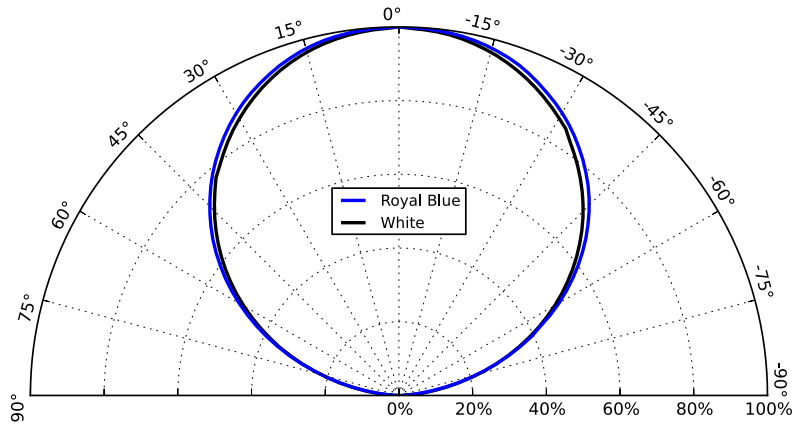

Figure 6: Typical polar radiation pattern for LMZx-xxxx at specified test current, $T_j=85^{\circ}\text{C}$.

Product Bin and Labeling Definitions

Decoding Product Bin Labeling

In the manufacturing of semiconductor products, there are variations in performance around the average values given in the technical datasheet. For this reason, Lumileds bins LED components for luminous flux or radiometric power, color point, peak or dominant wavelength and forward voltage.

Reels of LUXEON MZ LEDs are labeled using a 4-digit alphanumeric CAT code following the format below:

A B C D

- A** – designates color (W=White, R=Royal Blue)
- B** – designates color bin (example: 1=6500K, 2=5700K, 3=5000K, 5=4000K, 6=3500K, 7=3000K, 8=2700K, 00= Royal Blue)
- C** – designates color space (example: 5=5-step MacAdam Ellipse, 3=3-step MacAdam Ellipse)
- D** – designates forward voltage bin (example: F, G, H)

Therefore, LUXEON MZ with a lumen range of 630 to 680, color bin of 3000K, 5-step MacAdam ellipse and a forward voltage range of 2.63 to 2.75V for 3 volt parts has the following CAT code:

M 7 5 F

Reels of LUXEON MZ Royal Blue LEDs are labeled using a 3-digit alphanumeric CAT code following the format below:

A B C

- A** – designates radiometric power bin (example: B=4200 to 4400mW, D=4600 to 4800mW)
- B** – designates dominant wavelength bin (example: 5=450 to 455nm, 6=455 to 460nm)
- C** – designates forward voltage bin (example: F, G, H)

Therefore, a Royal Blue LUXEON MZ with a radiometric power range of 4200 to 4400mW, dominant wavelength 450 to 455nm a forward voltage range of 11.50 to 11.70V for 12 volt parts has the following CAT code:

B 5 H

Luminous Flux Bins

Table 5 lists the standard photometric luminous flux bins for LUXEON MZ emitters. Although several bins are outlined, product availability in a particular bin varies by production run and by product performance. Not all bins are available in all CCTs.

Table 5. Luminous flux bin definitions for LUXEON MZ White.

BIN	LUMINOUS FLUX (lm)	
	MINIMUM	MAXIMUM
K	550	590
L	590	630
M	630	680
N	680	730
P	730	780
Q	780	840
R	840	900
S	900	970
T	970	1040
U	1040	1120
V	1120	1200
W	1200	1290

Notes for Table 5:

1. Lumileds maintains a tolerance of $\pm 6.5\%$ on luminous flux measurements.

Radiometric Power Bins

Table 6. Radiometric power bin definitions for LUXEON MZ Royal Blue.

BIN	RADIOMETRIC POWER (mW)	
	MINIMUM	MAXIMUM
3	3500	3600
4	3600	3800
5	3800	4000
A	4000	4200
B	4200	4400

Notes for Table 6:

1. Lumileds maintains a tolerance of $\pm 6.5\%$ on radiometric power measurements.

Color Bin Definition

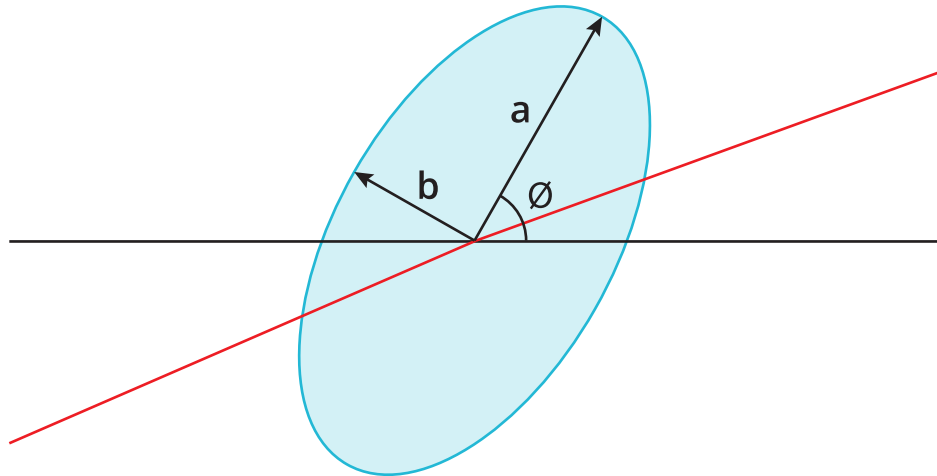

Figure 7: 3- and 5-step MacAdam ellipse illustration for Table 7.

Table 7. 3- and 5-step MacAdam ellipse color bin definitions for LUXEON MZ.

NOMINAL CCT	COLOR SPACE	CENTER POINT (cx, cy)	MAJOR AXIS, a	MINOR AXIS, b	ELLIPSE ROTATION ANGLE, θ
2700K	Single 3-step MacAdam ellipse	0.4578, 0.4101	0.00810	0.00420	53.70
3000K	Single 3-step MacAdam ellipse	0.4338, 0.4030	0.00834	0.00408	53.22
3500K	Single 3-step MacAdam ellipse	0.4073, 0.3917	0.00927	0.00414	54.00
4000K	Single 3-step MacAdam ellipse	0.3818, 0.3797	0.00939	0.00402	53.72
5000K	Single 3-step MacAdam ellipse	0.3447, 0.3553	0.00822	0.00354	59.62
2700K	Single 5-step MacAdam ellipse	0.4338, 0.4030	0.01390	0.00680	53.22
3000K	Single 5-step MacAdam ellipse	0.3818, 0.3797	0.01565	0.00670	53.72
3500K	Single 5-step MacAdam ellipse	0.3447, 0.3553	0.01370	0.00590	59.62
4000K	Single 5-step MacAdam ellipse	0.3287, 0.3417	0.01243	0.00533	59.09
5000K	Single 5-step MacAdam ellipse	0.3123, 0.3282	0.01115	0.00475	58.57

Notes for Table 7:

1. Lumileds maintains a tolerance of ± 0.005 on x and y coordinates in the CIE 1931 color space.

Dominant Wavelength Bins

Table 8. Dominant wavelength bin definition for LUXEON MZ Royal Blue.

BIN	DOMINANT WAVELENGTH (nm)	
	MINIMUM	MAXIMUM
4	445	450
5	450	455
6	455	460

Notes for Table 8:

1. Lumileds maintains a tolerance of ± 0.5 nm on dominant wavelength measurements.

Forward Voltage Bins

Table 9. Forward voltage bin definitions for LUXEON MZ.

PART NUMBER	BIN	FORWARD VOLTAGE (V) ⁽¹⁾	
		MINIMUM	MAXIMUM
LMZx-Sxxx	F	10.5	11.0
	G	11.0	11.5
	H	11.5	11.7
LMZx-Rxxx	F	5.25	5.50
	G	5.50	5.75
	H	5.75	6.00
LMZx-Qxxx	F	2.63	2.75
	G	2.75	2.88
	H	2.88	3.00

Notes for Table 9:

1. Lumileds maintains a tolerance of $\pm 0.06V$ on forward voltage measurements.

Mechanical Dimensions

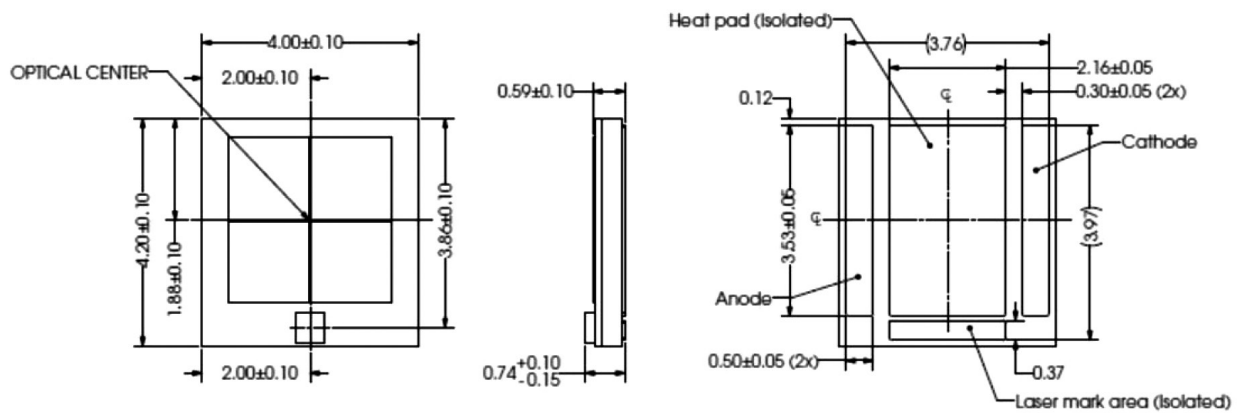

Figure 8: Mechanical dimensions for LUXEON MZ.

Notes for Figure 8:

1. Drawings are not to scale.
2. All dimensions are in millimeters.

Reflow Soldering Guidelines

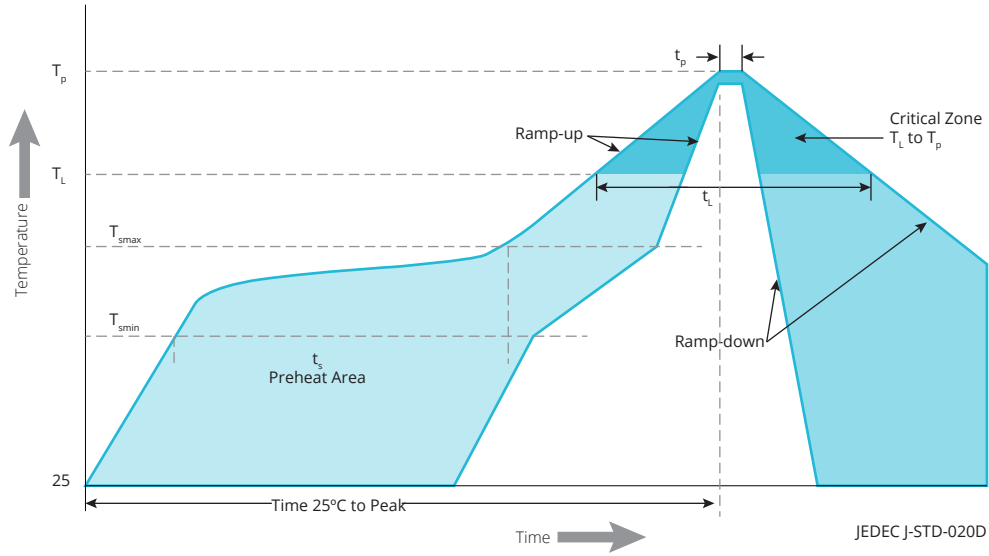

Figure 9: Visualization of the acceptable reflow temperature profile as specified in Table 10.

Table 10. Reflow profile characteristics for LUXEON MZ.

PROFILE FEATURE	LEAD-FREE ASSEMBLY
Preheat Minimum Temperature (T_{smin})	150°C
Preheat Maximum Temperature (T_{smax})	200°C
Preheat Time (t_{smin} to t_{smax})	60 to 120 seconds
Ramp-Up Rate (T_{smax} to T_p)	3°C / second maximum
Liquidus Temperature (T_L)	217°C
Time Maintained Above Temperature T_L (t_t)	60 to 150 seconds
Peak / Classification Temperature (T_p)	260°C
Time Within 5°C of Actual Temperature (t_p)	20 to 40 seconds
Ramp-Down Rate	6°C / second maximum
Time 25°C to Peak Temperature	8 minutes maximum

JEDEC Moisture Sensitivity

Table 11. Moisture sensitivity levels for LUXEON MZ.

LEVEL	FLOOR LIFE		SOAK REQUIREMENTS STANDARD	
	TIME	CONDITIONS	TIME	CONDITIONS
1	Unlimited	≤30°C / 85% RH	168 Hours +5 / -0	85°C / 85% RH

Solder Pad Design

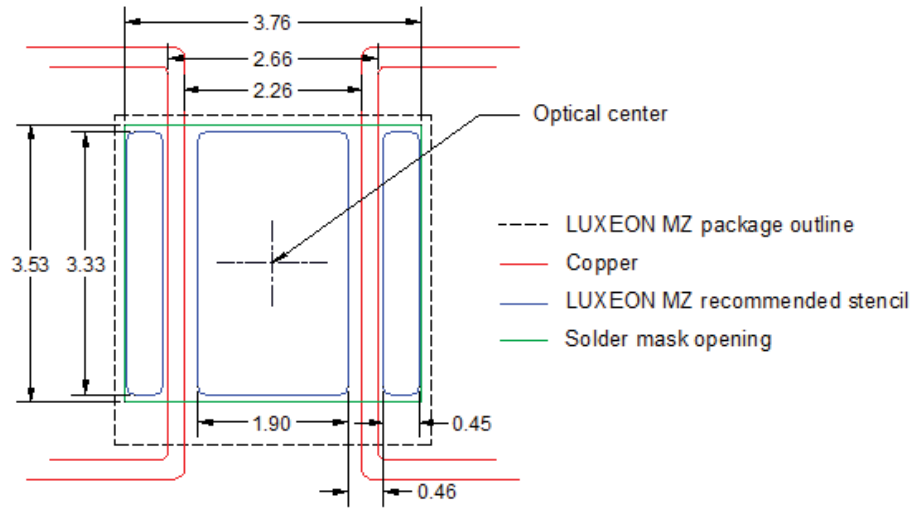

Figure 10: Recommended PCB solder pad layout for LUXEON MZ.

- Notes for Figure 10:
1. Drawings are not to scale.
 2. All dimensions are in millimeters.

Packaging Information

Pocket Tape Dimensions

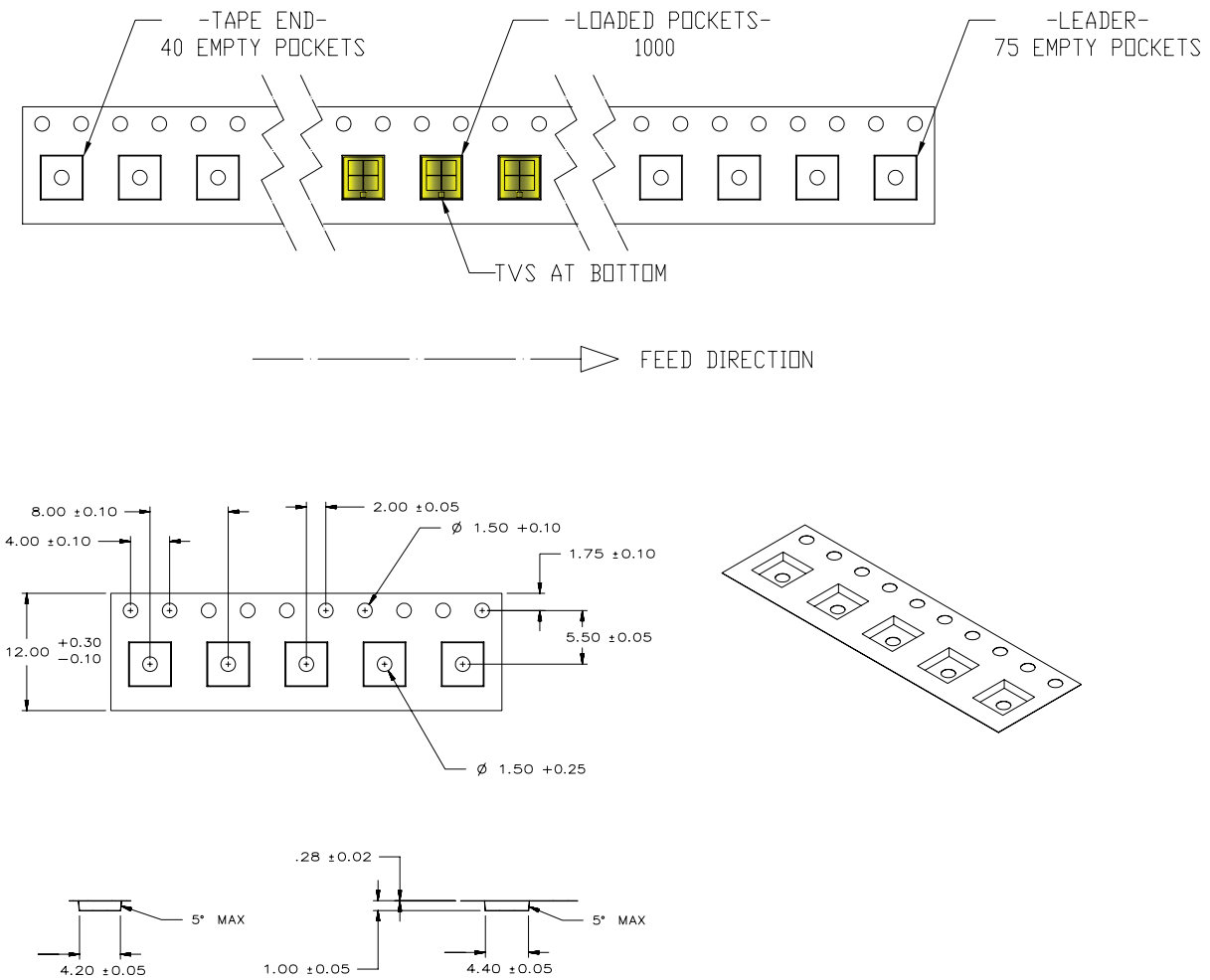

Figure 11: Pocket Tape dimensions for LUXEON MZ.

Notes for Figure 11:

1. Drawings are not to scale.
2. All dimensions are in millimeters.

Reel Dimensions

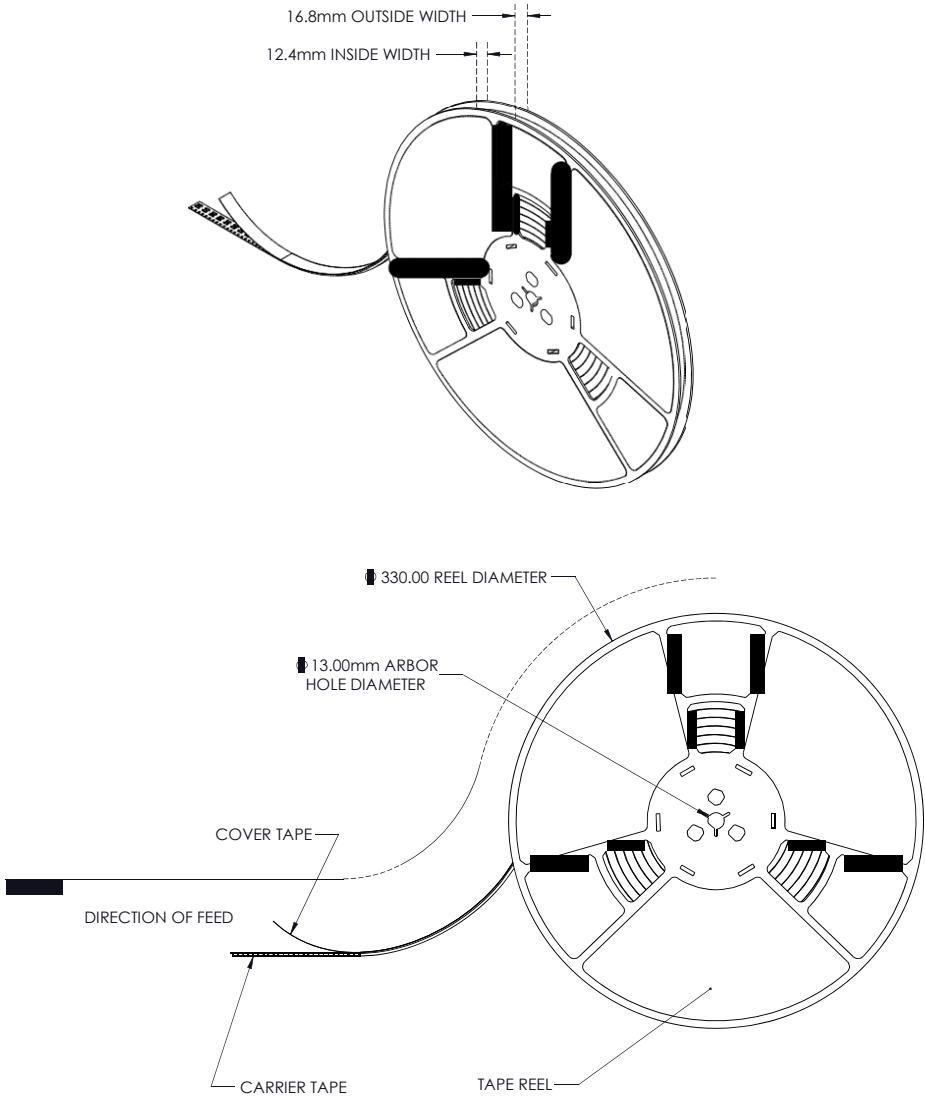

Figure 12: Reel dimensions for LUXEON MZ.

- Notes for Figure 12:
- 1. Drawings are not to scale.
 - 2. All dimensions are in millimeters.

About Lumileds

Lumileds is the light engine leader, delivering innovation, quality and reliability.

For 100 years, Lumileds commitment to innovation has helped customers pioneer breakthrough products in the automotive, consumer and illumination markets.

Lumileds is shaping the future of light with our LEDs and automotive lamps, and helping our customers illuminate how people see the world around them.

To learn more about our portfolio of light engines, visit lumileds.com.



©2015 Lumileds Holding B.V. All rights reserved.
LUXEON is a registered trademark of the Lumileds Holding B.V.
in the United States and other countries.
lumileds.com

Neither Lumileds Holding B.V. nor its affiliates shall be liable for any kind of loss of data or any other damages, direct, indirect or consequential, resulting from the use of the provided information and data. Although Lumileds Holding B.V. and/or its affiliates have attempted to provide the most accurate information and data, the materials and services information and data are provided "as is," and neither Lumileds Holding B.V. nor its affiliates warrants or guarantees the contents and correctness of the provided information and data. Lumileds Holding B.V. and its affiliates reserve the right to make changes without notice. You as user agree to this disclaimer and user agreement with the download or use of the provided materials, information and data.



Компания «ЭлектроПласт» предлагает заключение долгосрочных отношений при поставках импортных электронных компонентов на взаимовыгодных условиях!

Наши преимущества:

- Оперативные поставки широкого спектра электронных компонентов отечественного и импортного производства напрямую от производителей и с крупнейших мировых складов;
- Поставка более 17-ти миллионов наименований электронных компонентов;
- Поставка сложных, дефицитных, либо снятых с производства позиций;
- Оперативные сроки поставки под заказ (от 5 рабочих дней);
- Экспресс доставка в любую точку России;
- Техническая поддержка проекта, помощь в подборе аналогов, поставка прототипов;
- Система менеджмента качества сертифицирована по Международному стандарту ISO 9001;
- Лицензия ФСБ на осуществление работ с использованием сведений, составляющих государственную тайну;
- Поставка специализированных компонентов (Xilinx, Altera, Analog Devices, Intersil, Interpoint, Microsemi, Aeroflex, Peregrine, Syfer, Eurofarad, Texas Instrument, Miteq, Cobham, E2V, MA-COM, Hittite, Mini-Circuits, General Dynamics и др.);

Помимо этого, одним из направлений компании «ЭлектроПласт» является направление «Источники питания». Мы предлагаем Вам помощь Конструкторского отдела:

- Подбор оптимального решения, техническое обоснование при выборе компонента;
- Подбор аналогов;
- Консультации по применению компонента;
- Поставка образцов и прототипов;
- Техническая поддержка проекта;
- Защита от снятия компонента с производства.



Как с нами связаться

Телефон: 8 (812) 309 58 32 (многоканальный)

Факс: 8 (812) 320-02-42

Электронная почта: org@eplast1.ru

Адрес: 198099, г. Санкт-Петербург, ул. Калинина, дом 2, корпус 4, литера А.