

# DATA SHEET

## TRANSIENT VOLTAGE SUPPRESSORS

### AC/DC POWER SUPPLY

P6SMB series

RoHS compliant & Halogen free



Product specification— April 29, 2019 V.0



## Transient Voltage Suppressors (TVS) Data Sheet

### Features

- For surface mounted applications in order to optimize board space
- Low profile package
- Built-in strain relief
- Glass passivated junction
- Low inductance
- Excellent clamping capability
- 600W peak pulse power capability at 10/1000 $\mu$ s waveform, repetition rate (duty cycle): 0.01%
- Fast response time
- Typical  $I_R$  less than 1 $\mu$ A above 12V
- High Temperature soldering: 260 $^{\circ}$ C/10 seconds at terminals
- Plastic package has underwriters laboratory flammability 94V-0
- Meets MSL level 1, per J-STD-020
- Safety certification: UL: E244458



### Mechanical Data

- Case: JEDEC DO-214AA. Molded plastic over glass passivated junction
- Terminal: Solder plated, solderable per MIL-STD-750, Method 2026
- Polarity: Color band denotes cathode except bi-directional models
- Standard Packaging: 12mm tape (EIA STD RS-481)
- Weight: 0.10g

### Applications

- I/O interface
- AC/DC power supply
- Low frequency signal transmission line (RS232, RS485, etc.)

### Maximum Ratings and Characteristics

Ratings at 25 $^{\circ}$ C ambient temperature unless otherwise specified.

Rating	Symbol	Value	Units
Peak pulse power dissipation at 10/1000 $\mu$ s waveform (Note1, Note2, Fig.1)	$P_{PPM}$	Minimum 600	Watts
Peak pulse current of at 10/1000 $\mu$ s waveform (Note 1, Fig.3)	$I_{PPM}$	See Table	Amps
Steady state power dissipation at $T_A=50^{\circ}$ C (Fig.5)	$P_{M(AV)}$	5.0	Watts
Peak forward surge current, 8.3ms single half sine-wave superimposed on rated load, (JEDEC Method) (Note3, Fig.6)	$I_{FSM}$	100	Amps
Operating junction and Storage Temperature Range.	$T_J, T_{STG}$	-65 to +150	$^{\circ}$ C
Typical thermal resistance junction to lead	$R_{\theta JL}$	20	$^{\circ}$ C/W
Typical thermal resistance junction to ambient	$R_{\theta JA}$	100	$^{\circ}$ C/W

Notes: 1. Non-repetitive current pulse, per Fig.3 and derated above  $T_A=25^{\circ}$ C per Fig.2.

2. Mounted on 5.0mm $\times$ 5.0mm (0.03mm thick) copper pads to each terminal.

3. 8.3ms single half sine-wave, or equivalent square wave, duty cycle=4 pulses per minutes maximum.

**Dimensions (SMB/DO-214AA)**

	Symbol	Millimeters		Inches	
		Min.	Max.	Min.	Max.
	L	4.06	4.57	0.160	0.180
	D	3.30	3.94	0.130	0.155
	D1	1.95	2.20	0.077	0.086
	T	5.21	5.59	0.205	0.220
	T1	0.76	1.52	0.030	0.060
	d	-	0.203	-	0.008
	H	2.15	2.65	0.085	0.104
	H1	2.13	2.47	0.084	0.097

**Part Number Code**

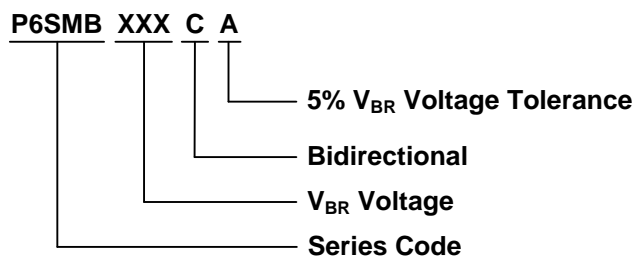

**Ordering Code for different package**

7 inch reel package: Add suffix "/TR7" at the end of the part number, such as P6SMBJ150A/TR7

13 inch reel package: Add suffix "/TR13" at the end of the part number, such as P6SMBJ250CA/TR13

**Electrical Characteristics (T<sub>A</sub>=25°C)**

Part Number		Device Marking Code		Reverse Stand-Off Voltage	Breakdown Voltage @I <sub>T</sub>	Test Current	Maximum Clamping Voltage @I <sub>PP</sub>	Peak Pulse Current	Reverse Leakage @V <sub>RWM</sub>
Unidirectional	Bidirectional	UNI	BI	V <sub>RWM</sub> (V)	V <sub>BR</sub> (V)	I <sub>T</sub> (mA)	V <sub>C</sub> (V)	I <sub>PP</sub> (A)	I <sub>R</sub> (μA)
P6SMB6.8A	P6SMB6.8CA	6V8A	6V8C	5.80	6.45~7.14	10	10.5	58.1	1000
P6SMB7.5A	P6SMB7.5CA	7V5A	7V5C	6.40	7.13~7.88	10	11.3	54.0	500
P6SMB8.2A	P6SMB8.2CA	8V2A	8V2C	7.02	7.79~8.61	10	12.1	50.4	200
P6SMB9.1A	P6SMB9.1CA	9V1A	9V1C	7.78	8.65~9.55	1	13.4	45.5	50
P6SMB10A	P6SMB10CA	10A	10C	8.55	9.50~10.50	1	14.5	42.1	10
P6SMB11A	P6SMB11CA	11A	11C	9.40	10.50~11.60	1	15.6	39.1	5
P6SMB12A	P6SMB12CA	12A	12C	10.20	11.40~12.60	1	16.7	36.5	5
P6SMB13A	P6SMB13CA	13A	13C	11.10	12.40~13.70	1	18.2	33.5	1
P6SMB15A	P6SMB15CA	15A	15C	12.80	14.30~15.80	1	21.2	28.8	1

**Transient Voltage Suppressors**

P6SMB

**Electrical Characteristics (T<sub>A</sub>=25°C)**

Part Number		Device Marking Code		Reverse Stand-Off Voltage	Breakdown Voltage @I <sub>T</sub>	Test Current	Maximum Clamping Voltage @I <sub>PP</sub>	Peak Pulse Current	Reverse Leakage @V <sub>RWM</sub>
Unidirectional	Bidirectional	UNI	BI	V <sub>RWM</sub> (V)	V <sub>BR</sub> (V)	I <sub>T</sub> (mA)	V <sub>C</sub> (V)	I <sub>PP</sub> (A)	I <sub>R</sub> (μA)
P6SMB16A	P6SMB16CA	16A	16C	13.60	15.20~16.80	1	22.5	27.1	1
P6SMB18A	P6SMB18CA	18A	18C	15.30	17.10~18.90	1	25.2	24.2	1
P6SMB20A	P6SMB20CA	20A	20C	17.10	19.00~21.00	1	27.7	22.0	1
P6SMB22A	P6SMB22CA	22A	22C	18.80	20.90~23.10	1	30.6	19.9	1
P6SMB24A	P6SMB24CA	24A	24C	20.50	22.80~25.20	1	33.2	18.4	1
P6SMB27A	P6SMB27CA	27A	27C	23.10	25.70~28.40	1	37.5	16.3	1
P6SMB30A	P6SMB30CA	30A	30C	25.60	28.50~31.50	1	41.4	14.7	1
P6SMB33A	P6SMB33CA	33A	33C	28.20	31.40~34.70	1	45.7	13.3	1

Part Number		Device Marking Code		Reverse Stand-Off Voltage	Breakdown Voltage @I <sub>T</sub>	Test Current	Maximum Clamping Voltage @I <sub>PP</sub>	Peak Pulse Current	Reverse Leakage @V <sub>RWM</sub>
Unidirectional	Bidirectional	UNI	BI	V <sub>RWM</sub> (V)	V <sub>BR</sub> (V)	I <sub>T</sub> (mA)	V <sub>C</sub> (V)	I <sub>PP</sub> (A)	I <sub>R</sub> (μA)
P6SMB36A	P6SMB36CA	36A	36C	30.80	34.20~37.80	1	49.9	12.2	1
P6SMB39A	P6SMB39CA	39A	39C	33.30	37.10~41.00	1	53.9	11.3	1
P6SMB43A	P6SMB43CA	43A	43C	36.80	40.90~45.20	1	59.3	10.3	1
P6SMB47A	P6SMB47CA	47A	47C	40.20	44.70~49.40	1	64.8	9.4	1
P6SMB51A	P6SMB51CA	51A	51C	43.60	48.50~53.60	1	70.1	8.7	1
P6SMB56A	P6SMB56CA	56A	56C	47.80	53.20~58.80	1	77.0	7.9	1
P6SMB62A	P6SMB62CA	62A	62C	53.00	58.90~65.10	1	85.0	7.2	1
P6SMB68A	P6SMB68CA	68A	68C	58.10	64.60~71.40	1	92.0	6.6	1
P6SMB75A	P6SMB75CA	75A	75C	64.10	71.30~78.80	1	103.0	5.9	1
P6SMB82A	P6SMB82CA	82A	82C	70.10	77.90~86.10	1	113.0	5.4	1
P6SMB91A	P6SMB91CA	91A	91C	77.80	86.50~95.50	1	125.0	4.9	1
P6SMB100A	P6SMB100CA	100A	100C	85.50	95.00~105.00	1	137.0	4.5	1
P6SMB110A	P6SMB110CA	110A	110C	94.00	105.00~116.00	1	152.0	4.0	1
P6SMB120A	P6SMB120CA	120A	120C	102.00	114.00~126.00	1	165.0	3.7	1
P6SMB130A	P6SMB130CA	130A	130C	111.00	124.00~137.00	1	179.0	3.4	1
P6SMB150A	P6SMB150CA	150A	150C	128.00	143.00~158.00	1	207.0	2.9	1
P6SMB160A	P6SMB160CA	160A	160C	136.00	152.00~168.00	1	219.0	2.8	1
P6SMB170A	P6SMB170CA	170A	170C	145.00	162.00~179.00	1	234.0	2.6	1
P6SMB180A	P6SMB180CA	180A	180C	154.00	171.00~189.00	1	246.0	2.5	1
P6SMB200A	P6SMB200CA	200A	200C	171.00	190.00~210.00	1	274.0	2.2	1

**Electrical Characteristics (T<sub>A</sub>=25°C)**

Part Number		Device Marking Code		Reverse Stand-Off Voltage	Breakdown Voltage @I <sub>T</sub>	Test Current	Maximum Clamping Voltage @I <sub>PP</sub>	Peak Pulse Current	Reverse Leakage @V <sub>RWM</sub>
Unidirectional	Bidirectional	UNI	BI	V <sub>RWM</sub> (V)	V <sub>BR</sub> (V)	I <sub>T</sub> (mA)	V <sub>C</sub> (V)	I <sub>PP</sub> (A)	I <sub>R</sub> (μA)
P6SMB220A	P6SMB220CA	220A	220C	185.00	209.00~231.00	1	328.0	1.9	1
P6SMB250A	P6SMB250CA	250A	250C	214.00	237.00~263.00	1	344.0	1.8	1
P6SMB300A	P6SMB300CA	300A	300C	256.00	285.00~315.00	1	414.0	1.5	1
P6SMB350A	P6SMB350CA	350A	350C	300.00	332.00~368.00	1	482.0	1.3	1
P6SMB400A	P6SMB400CA	400A	400C	342.00	380.00~420.00	1	548.0	1.1	1
P6SMB440A	P6SMB440CA	440A	440C	376.00	418.00~462.00	1	602.0	1.0	1
P6SMB480A	P6SMB480CA	480A	480C	408.00	456.00~504.00	1	658.0	0.9	1
P6SMB510A	P6SMB510CA	510A	510C	434.00	485.00~535.00	1	698.0	0.9	1
P6SMB530A	P6SMB530CA	530A	530C	450.00	503.50~556.50	1	725.0	0.8	1
P6SMB540A	P6SMB540CA	540A	540C	459.00	513.00~567.00	1	740.0	0.8	1
P6SMB550A	P6SMB550CA	550A	550C	467.00	522.50~577.50	1	760.0	0.8	1

Notes: For bidirectional type having V<sub>RWM</sub> of 10V and less, the I<sub>R</sub> limit is double.

Ratings and Characteristic Curves ( $T_A=25^\circ\text{C}$  unless otherwise noted)

Figure 1. Peak Pulse Power Rating Curve

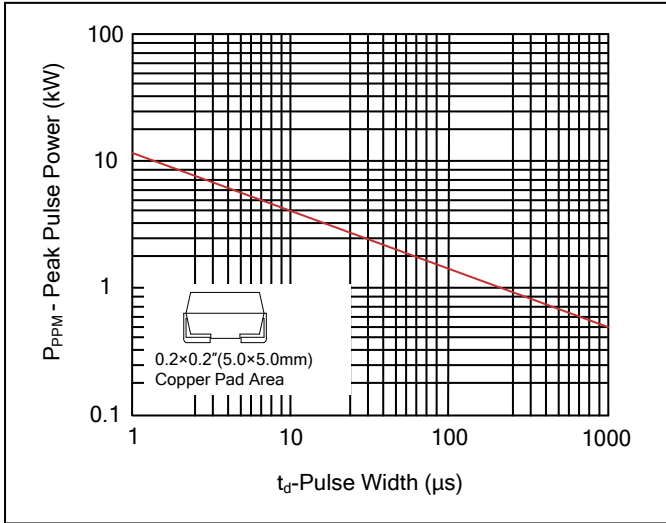

Figure 2. Pulse Derating Curve

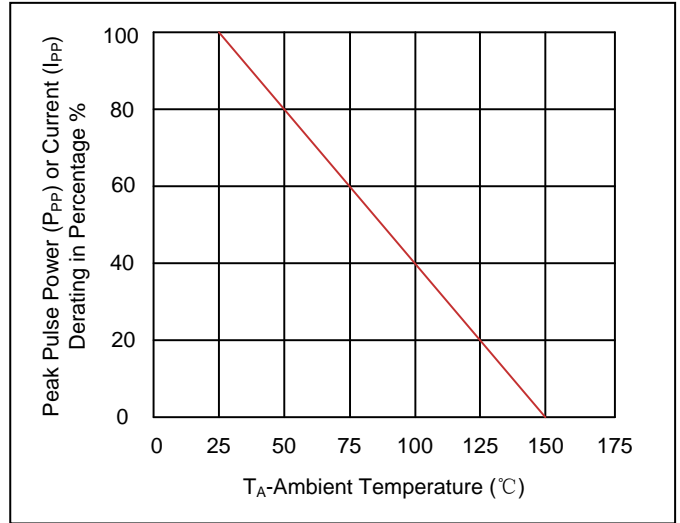

Figure 3. Pulse Waveform

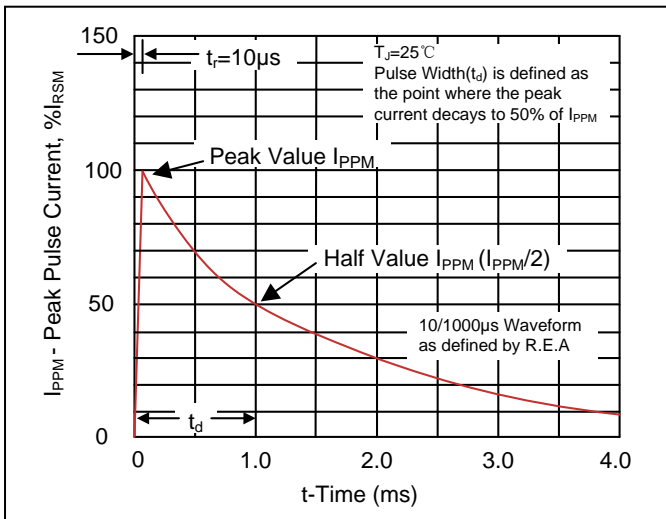

Figure 4. Typical Junction Capacitance

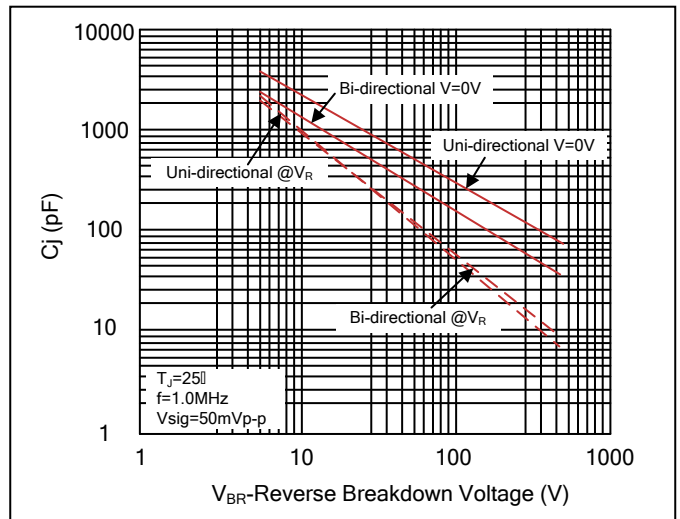

Figure 5. Steady State Power Dissipation Derating Curve

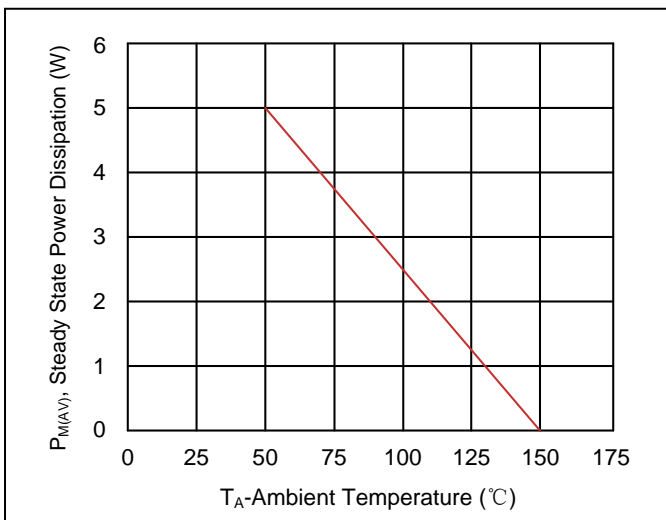
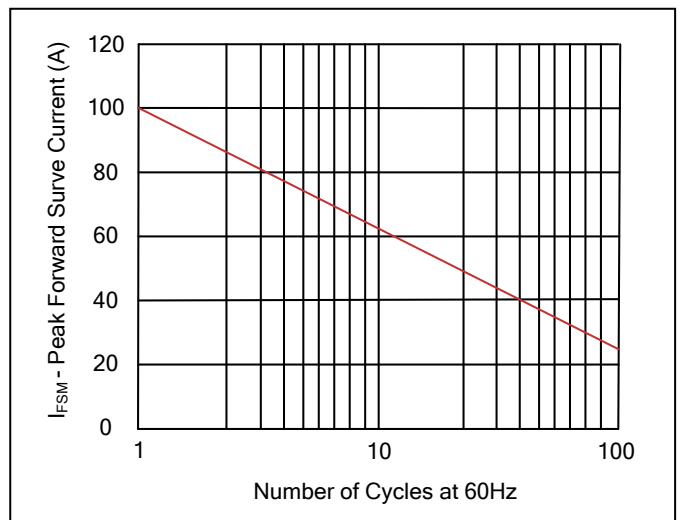
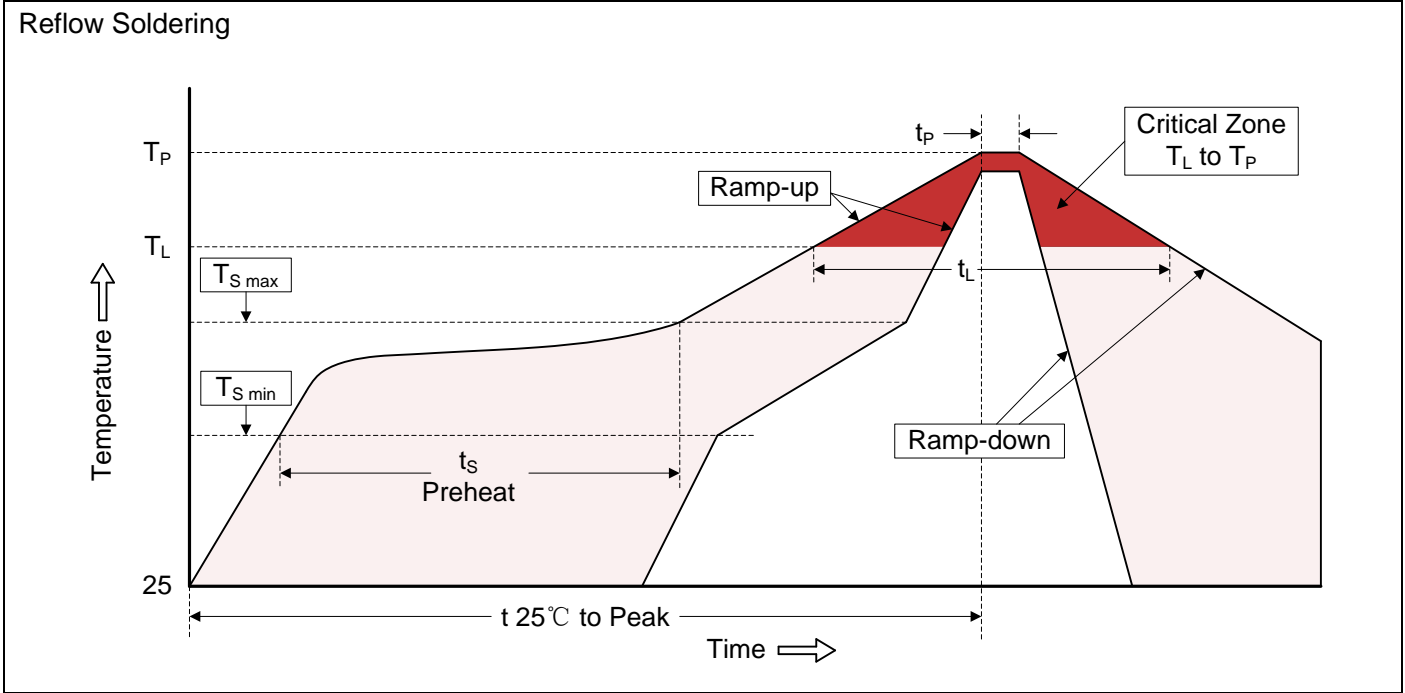

Figure 6. Maximum Non-Repetitive Forward Surge Current Uni-Directional Only



### Recommended Soldering Conditions



### Recommended Conditions

Profile Feature	Pb-Free Assembly
Average ramp-up rate ( $T_L$ to $T_P$ )	3°C/second max.
Preheat <ul style="list-style-type: none"> <li>-Temperature Min (<math>T_{S\ min}</math>)</li> <li>-Temperature Max (<math>T_{S\ max}</math>)</li> <li>-Time (min to max) (<math>t_s</math>)</li> </ul>	150°C 200°C 60-180 seconds
$T_{S\ max}$ to $T_L$ <ul style="list-style-type: none"> <li>-Ramp-up Rate</li> </ul>	3°C/second max.
Time maintained above: <ul style="list-style-type: none"> <li>-Temperature (<math>T_L</math>)</li> <li>-Time (<math>t_L</math>)</li> </ul>	217°C 60-150 seconds
Peak Temperature ( $T_P$ )	260°C
Time within 5°C of actual Peak Temperature ( $t_p$ )	20-40 seconds
Ramp-down Rate	6°C/second max.
Time 25°C to Peak Temperature	8 minutes max.

### Marking Code

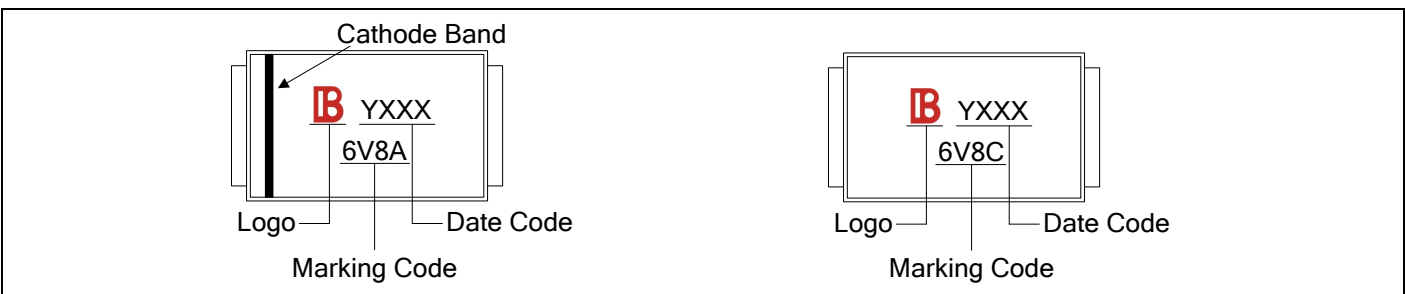

**Packaging**

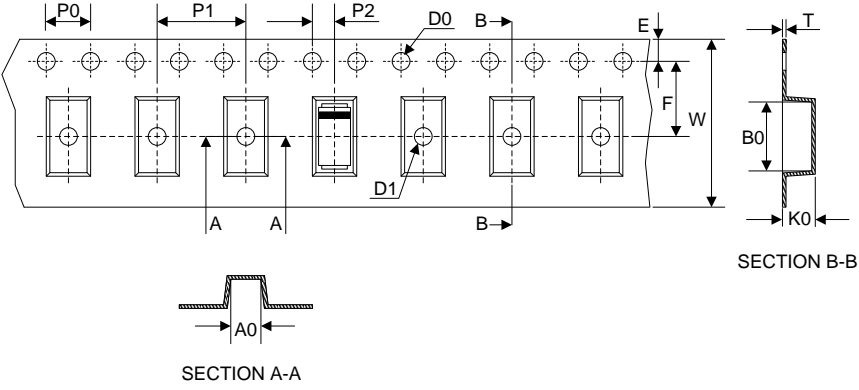
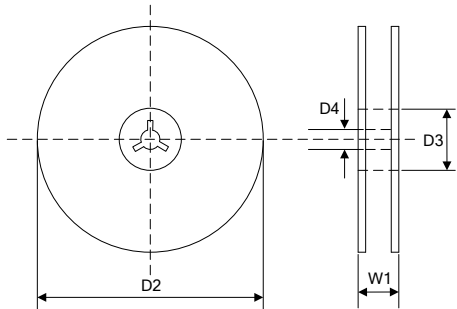
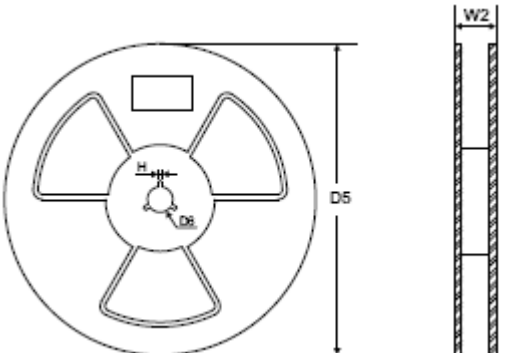
Tape	Symbol	Dimension (mm)
	W	12.00±0.20
	P0	4.00±0.10
	P1	8.00±0.10
	P2	2.00±0.10
	D0	Φ1.55±0.10
	D1	Φ1.5±0.10
	E	1.75±0.10
	F	5.50±0.10
	A0	3.86±0.15
	B0	5.65±0.10
	K0	2.75±0.15
	T	0.25±0.05
	<p><b>7" Reel</b></p> 	D2
D3		Φ50.0Min.
D4		Φ13.0±0.5
W1		16.0±2.0
Quantity: 500PCS		
<p><b>13" Reel</b></p> 	D5	Φ330.0±2.0
	D6	Φ13.5±0.5
	H	2.5±1.0
	W2	16.0±2.0
	Quantity: 3000PCS	





Компания «ЭлектроПласт» предлагает заключение долгосрочных отношений при поставках импортных электронных компонентов на взаимовыгодных условиях!

Наши преимущества:

- Оперативные поставки широкого спектра электронных компонентов отечественного и импортного производства напрямую от производителей и с крупнейших мировых складов;
- Поставка более 17-ти миллионов наименований электронных компонентов;
- Поставка сложных, дефицитных, либо снятых с производства позиций;
- Оперативные сроки поставки под заказ (от 5 рабочих дней);
- Экспресс доставка в любую точку России;
- Техническая поддержка проекта, помощь в подборе аналогов, поставка прототипов;
- Система менеджмента качества сертифицирована по Международному стандарту ISO 9001;
- Лицензия ФСБ на осуществление работ с использованием сведений, составляющих государственную тайну;
- Поставка специализированных компонентов (Xilinx, Altera, Analog Devices, Intersil, Interpoint, Microsemi, Aeroflex, Peregrine, Syfer, Eurofarad, Texas Instrument, Miteq, Cobham, E2V, MA-COM, Hittite, Mini-Circuits, General Dynamics и др.);

Помимо этого, одним из направлений компании «ЭлектроПласт» является направление «Источники питания». Мы предлагаем Вам помощь Конструкторского отдела:

- Подбор оптимального решения, техническое обоснование при выборе компонента;
- Подбор аналогов;
- Консультации по применению компонента;
- Поставка образцов и прототипов;
- Техническая поддержка проекта;
- Защита от снятия компонента с производства.



#### Как с нами связаться

**Телефон:** 8 (812) 309 58 32 (многоканальный)

**Факс:** 8 (812) 320-02-42

**Электронная почта:** [org@eplast1.ru](mailto:org@eplast1.ru)

**Адрес:** 198099, г. Санкт-Петербург, ул. Калинина, дом 2, корпус 4, литера А.