

# Avago

## 20 & 26.5mm

### Range



#### Carclo Technical Plastics

111 Buckingham Avenue, Slough, Berkshire SL1 4PF ENGLAND / 600 Depot Street Latrobe PA. 15650 USA

Web: [www.carclo-optics.com](http://www.carclo-optics.com) e-mail: [sales@carclo-optics.com](mailto:sales@carclo-optics.com)

Tel UK: 0044 (0) 1753 575011 Tel USA 00 (1) 724 539 6982

# Avago Aveon 20 & 26.5mm Range

## **Carclo Technical Plastics**

111 Buckingham Avenue, Slough, Berkshire SL1 4PF ENGLAND / 600 Depot Street Latrobe PA. 15650 USA

Web: [www.carclo-optics.com](http://www.carclo-optics.com) e-mail: [sales@carclo-optics.com](mailto:sales@carclo-optics.com)

Tel UK: 0044 (0) 1753 575011 Tel USA 00 (1) 724 539 6982



**carclo**  
technical plastics

# Avago Aveon 20mm range

Part No.	Description	White		
		FWHM#	EFF	Cd/lm
10199	Plain Tight	9.25*9.07	85.9%	19.76
10200	Frosted Narrow	12.98*12.64	83.2%	11.33
10210	Ripple Medium	22.16*21.37	85.9%	5.79
10201	Medium Frosted	21.86*21.67	79.9%	3.98
10211	Ripple Wide	45.21*45.26	83.4%	1.68
10202	Wide Frosted	31.51*31.17	79.0%	2.46
10203	Elliptical	47.99*9.54	83.1%	4.58
10204	Elliptical Orthogonal*	47.45*10.01	81.8%	4.47
10357	wide angle reflector			

\*Orthogonal is the elliptical beam turned through 90deg.

#Full Width Half Maximum i.e. total viewing angle

Base of lens to PCB height is 3.6mm

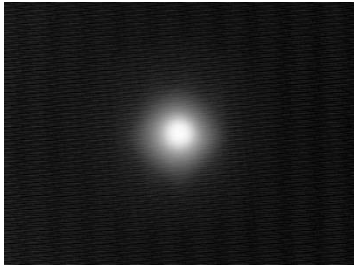

10199

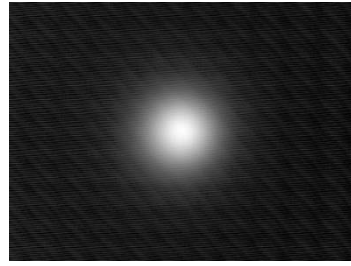

10200

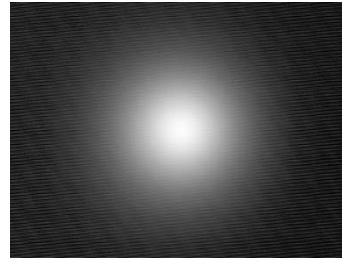

10201

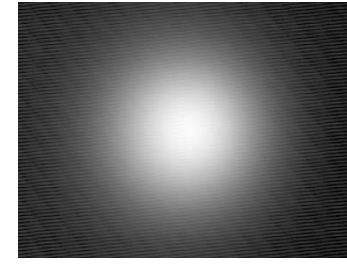

10202

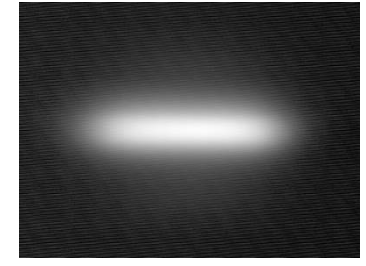

10203 & 10204

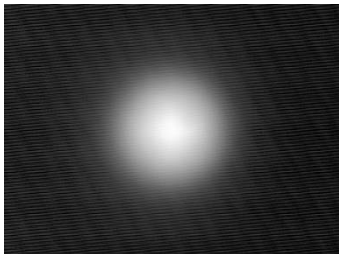

10210

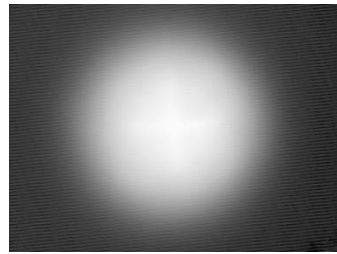

10211

# Avago Aveon 26.5mm range

Part No.	Description	White		
		FWHM#	EFF	Cd/lm
10048	Plain Tight	6.91*6.89	84.9%	25.65
10124	Frosted Narrow	11.27*10.94	81.8%	13.79
10108	Medium Frosted	22.32*21.97	78.7%	3.92
10260	Frosted Wide	Optic will not fit LED		
10049	Elliptical	44.01*8.14	80.3%	5.80
10224	Elliptical Orthogonal*	48.25*8.14	80.8%	5.35
10234	Elliptical Ramp Optic	45.61*7.83	80.0%	5.57



Part No.	Colour	Description
10449	White	4.3mm foot (not Stocked)
10459	White	2.0mm foot (Not Stocked)
10469	White	0.8mm foot (Stocked)
10479	Black	4.3mm foot (Not Stocked)
10489	Black	2.0mm foot (Not Stocked)
10499	Black	0.8mm foot (Not Stocked)

\*Orthogonal is the elliptical beam turned through 90deg.

# Full Width Half Maximum i.e. total viewing angle

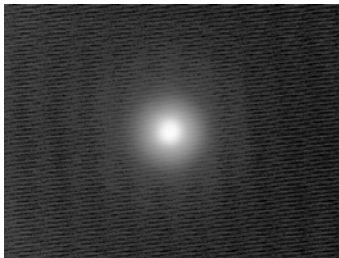

10048

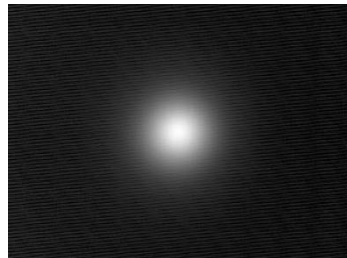

10124

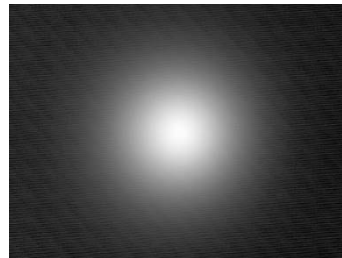

10108

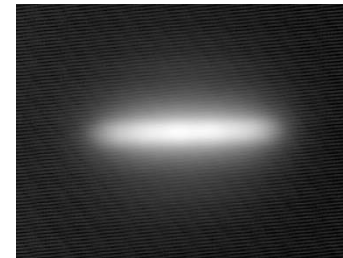

10049 & 10224

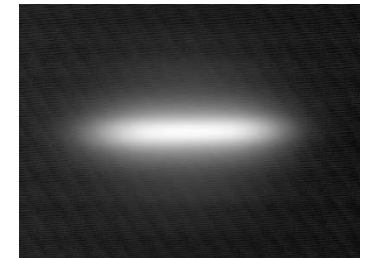

10234

# Avago Jade 20 & 26.5mm Range

## **Carclo Technical Plastics**

111 Buckingham Avenue, Slough, Berkshire SL1 4PF ENGLAND / 600 Depot Street Latrobe PA. 15650 USA

Web: [www.carclo-optics.com](http://www.carclo-optics.com) e-mail: [sales@carclo-optics.com](mailto:sales@carclo-optics.com)

Tel UK: 0044 (0) 1753 575011 Tel USA 00 (1) 724 539 6982



**carclo**  
technical plastics

# Avago Jade 20mm range

Part No.	Description	White		
		FWHM#	EFF	Cd/lm
10003	Plain Tight	11.27*11.25	90.1%	12
10138	Frosted Narrow	16.53*16.80	91.6%	7.59
10003/15	Ripple Medium	20.14*20.54	90.7%	3.92
10139	Medium Frosted	23.22*23.03	87.4%	4.25
10003/25	Ripple Wide	36.33*34.19	85.3%	2.24
10140	Wide Frosted	31.37*31.60	82.2%	2.51
10003/L25	Elliptical	44.14*14.80	89.3%	4.01
10192	Elliptical Orthogonal*	46.94*13.72	90.1%	3.99
10034	wide angle reflector			

\*Orthogonal is the elliptical beam turned through 90deg.

#Full Width Half Maximum i.e. total viewing angle

Base of lens to PCB height is 3.6mm

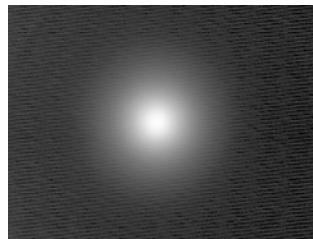

10003

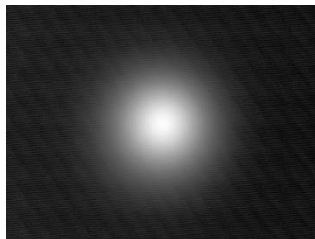

10138

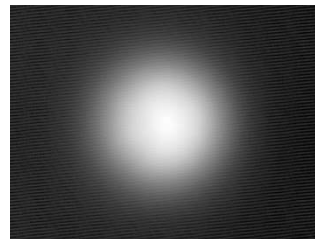

10003/15

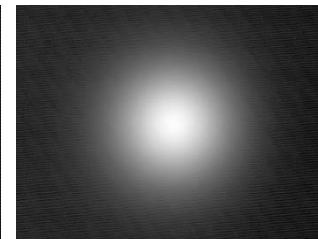

10139

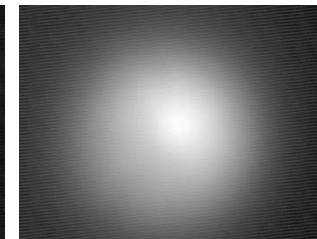

10003/25

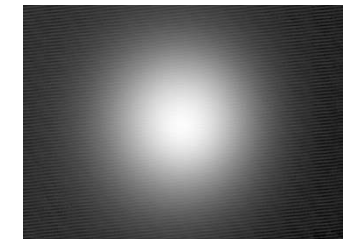

10140

# Avago Jade 26.5mm range

Part No.	Description	White		
		FWHM#	EFF	Cd/lm
10048	Plain Tight	8.31*8.14	88.8%	20.07
10124	Frosted Narrow	13.59*13.26	86.6%	11.15
10108	Medium Frosted	23.82*23.78	81.7%	4.01
10260	Frosted Wide	28.15*28.09	82.1%	3.05
10049	Elliptical	43.87*10.94	85.5%	5.40
10224	Elliptical Orthogonal*	47.19*11.25	85.1%	4.60
10234	Elliptical Ramp Optic	45.17*10.94	85.1%	5.30

Part No.	Colour	Description
10441	White	4.3mm foot (not Stocked)
10451	White	2.0mm foot (Not Stocked)
10461	White	0.8mm foot (Stocked)
10471	Black	4.3mm foot (Not Stocked)
10481	Black	2.0mm foot (Not Stocked)
10491	Black	0.8mm foot (Not Stocked)

\*Orthogonal is the elliptical beam turned through 90deg.

# Full Width Half Maximum i.e. total viewing angle

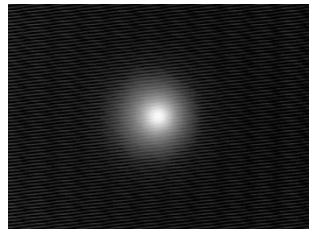

10048

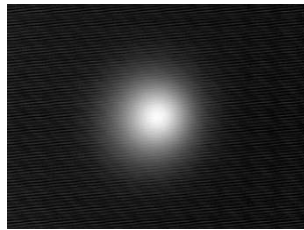

10124

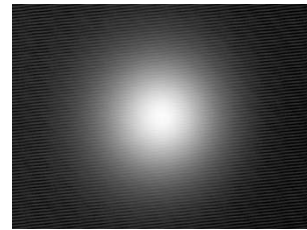

10108

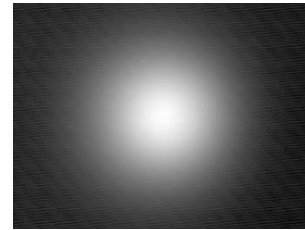

10260

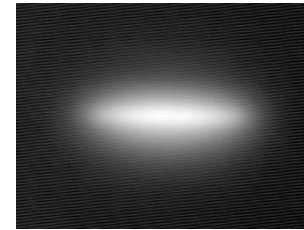

1049 & 10224

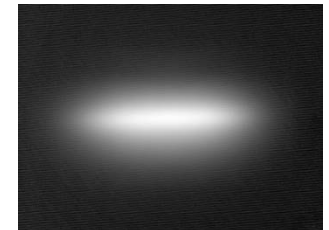

10234

# Avago Moonstone 20 & 26.5mm Range



## Carclo Technical Plastics

111 Buckingham Avenue, Slough, Berkshire SL1 4PF ENGLAND / 600 Depot Street Latrobe PA. 15650 USA

Web: [www.carclo-optics.com](http://www.carclo-optics.com) e-mail: [sales@carclo-optics.com](mailto:sales@carclo-optics.com)

Tel UK: 0044 (0) 1753 575011 Tel USA 00 (1) 724 539 6982



# Avago Moonstone 20mm range

Part No.	Description	Warm White		
		FWHM#	EFF	Cd/lm
10199	Plain Tight	11.12*11.09	88.5%	8.19
10200	Frosted Narrow	17.81*17.41	88%	5.31
10210	Ripple Medium	26.46*25.97	87.7%	3.24
10201	Medium Frosted	27.77*27.28	82.8%	2.43
10211	Ripple Wide	46.49*46.02	83.9%	1.24
10202	Wide Frosted	39.32*40.35	80.6%	1.41
10203	Elliptical	45.97*17.33	85.7%	2.66
10204	Elliptical Orthogonal*	45.23*20.03	84.5%	2.29
10357	wide angle reflector			



\*Orthogonal is the elliptical beam turned through 90deg.

#Full Width Half Maximum i.e. total viewing angle

Base of lens to PCB height is 3.6mm

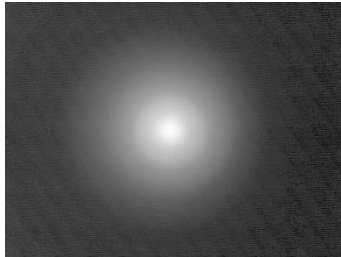

10199

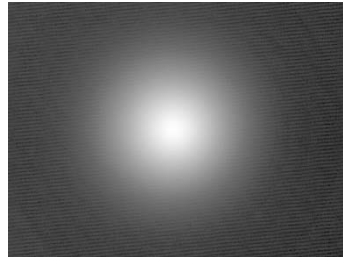

10200

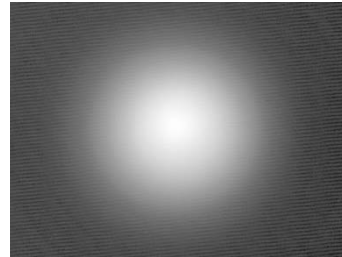

10210

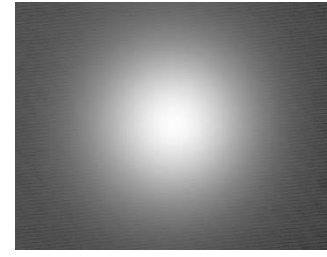

10201

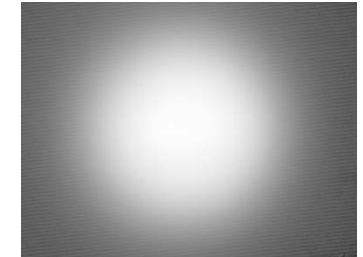

10211

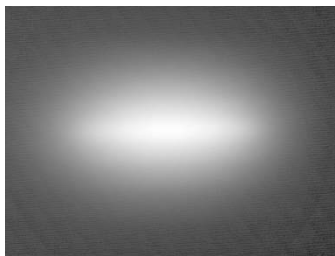

10203 & 10204

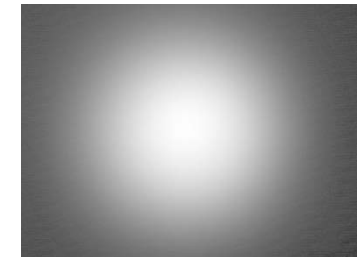

10202

# Avago Moonstone 26.5mm range

Part No.	Description	Warm White		
		FWHM <sup>#</sup>	EFF	Cd/lm
10391	Plain Tight	12	87.2%	10.50
10392	Frosted Narrow	17.2	83.1%	6.00
10393	Medium Frosted	25.5	78.5%	2.76
10394	Frosted Wide			
10395	Elliptical	44*16	83.1%	2.99

WHITE HOLDERS			BLACK HOLDERS		
4.3 PEG Not Stocked	2.0 PEG Not stocked	0.8 PEG Stocked	4.3 PEG Not Stocked	2.0 PEG Not Stocked	0.8 PEG Not Stocked
10449	10459	10469	10479	10489	10499

Results for white LED

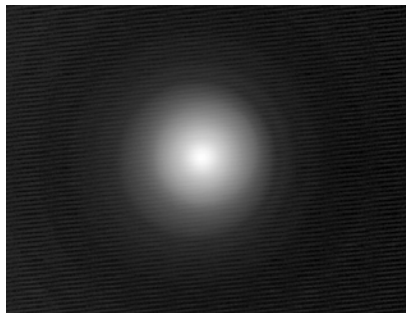

10391

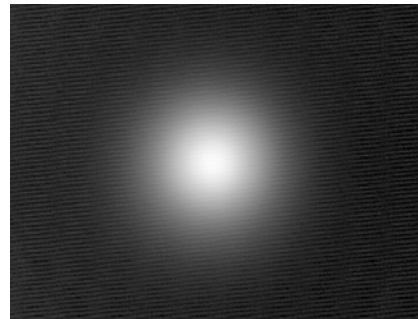

10392

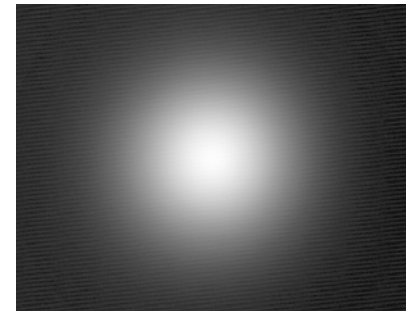

10393

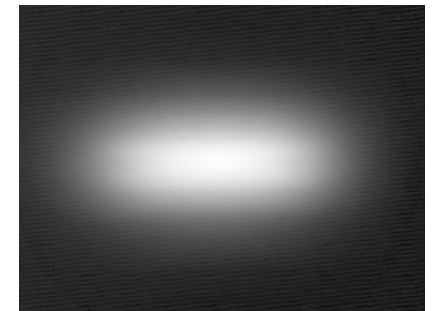

10395

# Avago RGB Moonstone 20mm range

Part No.	Description	White		
		FWHM#	EFF	Cd/lm
10199	Plain Tight	13.10*13.54	86.2%	12.17
10200	Frosted Narrow	17.81*17.41	85.1%	6.71
10201	Medium Frosted	25.43*25.96	81.0%	2.73
10202	Wide Frosted	38.02*38.09	76.7%	1.38

\*Orthogonal is the elliptical beam turned through 90deg.

#Full Width Half Maximum i.e. total viewing angle

Base of lens to PCB height is 3.6mm

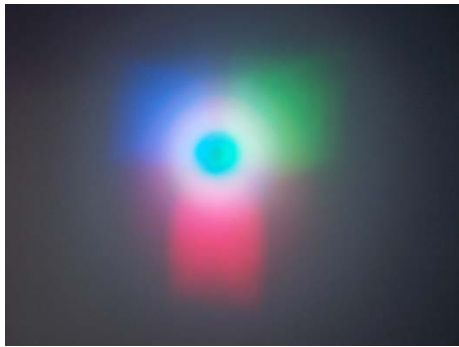

10199

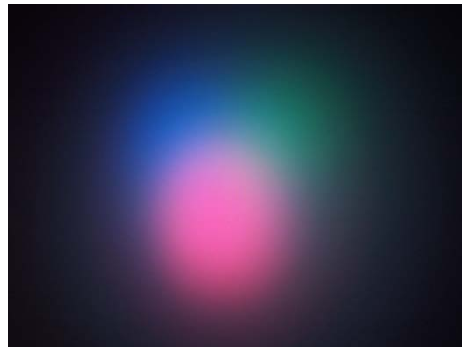

10200

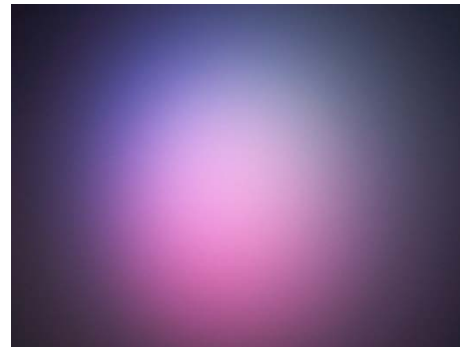

10201

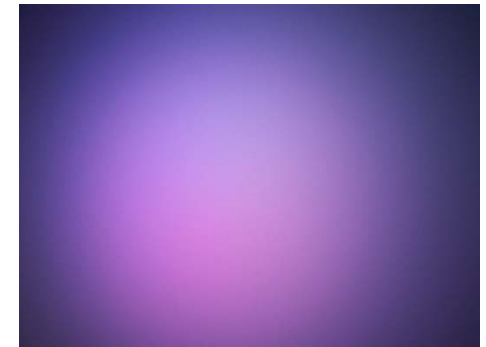

10202

# Avago RGB Moonstone 26.5mm range

Part No.	Description	Warm White		
		FWHM <sup>#</sup>	EFF	Cd/lm
10391	Plain Tight	12.2	87.2%	13
10392	Frosted Narrow	15.9	88%	6.30
10393	Medium Frosted	26.5	81%	2.4
10394	Frosted Wide	29.1	84.7%	2.2
10395	Elliptical			

WHITE HOLDERS			BLACK HOLDERS		
4.3 PEG Not Stocked	2.0 PEG Not stocked	0.8 PEG Stocked	4.3 PEG Not Stocked	2.0 PEG Not Stocked	0.8 PEG Not Stocked
10449	10459	10469	10479	10489	10499

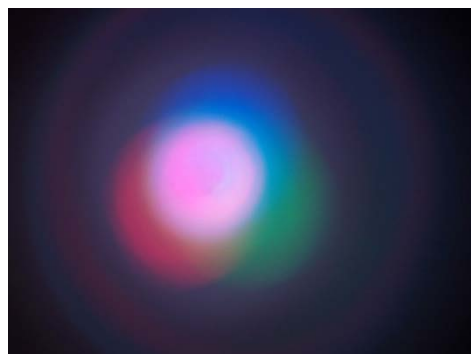

10391

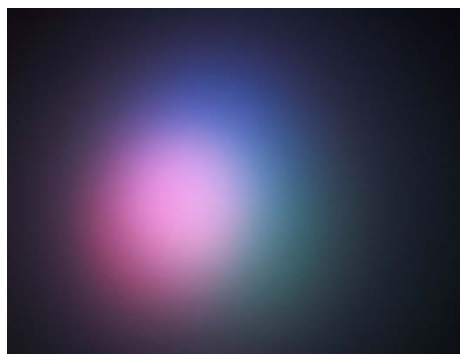

10392

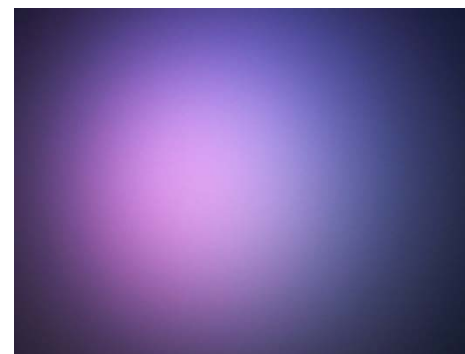

10393

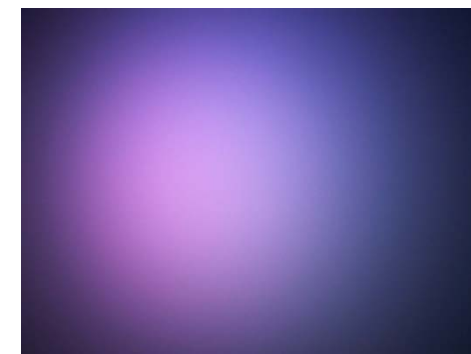

10394

# 26.5mm OPTIC

Part No.	TYPE
10391	Plain Tight
10392	Narrow Frosted
10393	Medium Frosted
10394	Wide Frosted
10395	Elliptical
10396	Elliptical Ortho

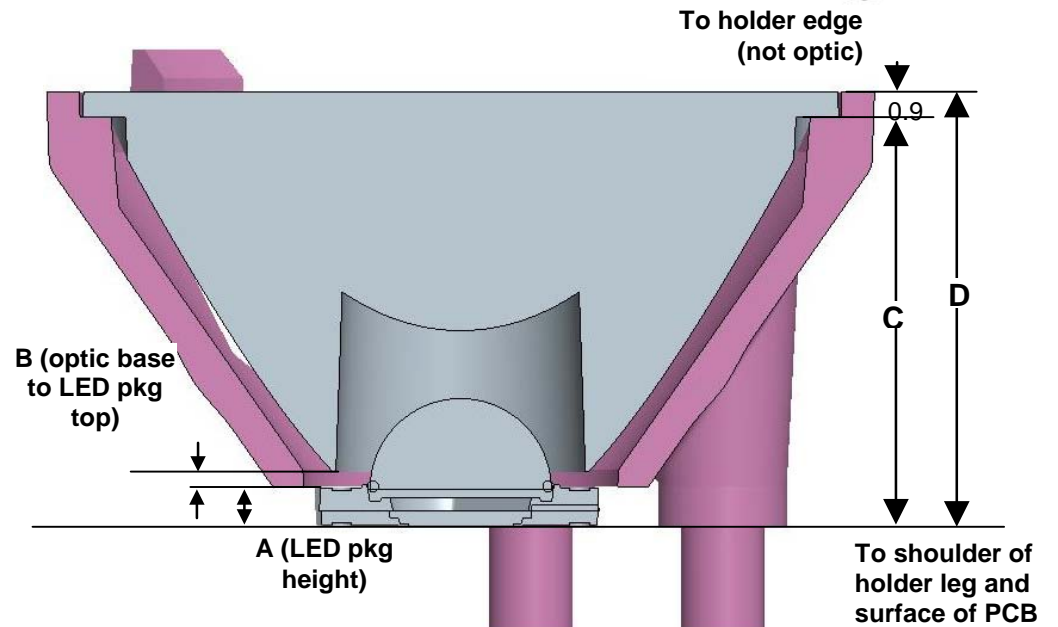
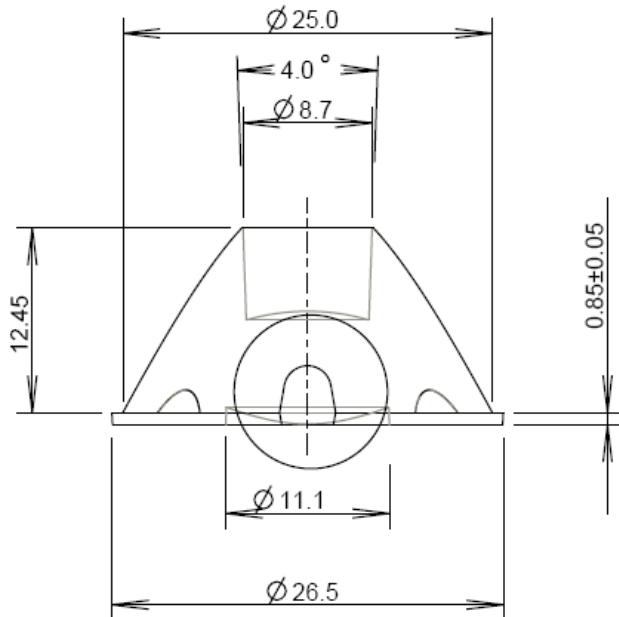

## Notes:

- CARCLO multi-chip holder compatible with LED package mounted on 19.9mm (across flats) star board, otherwise drill holes on PCB for location pegs on legs. Refer to Drawing 60475 for hole separation
- The multichip holder leg height includes an extra 1.0mm for the AcuLED since only a 13mm (across flats) star board is available. The CARCLO holder reaches over the AcuLED star board so that the holder sits directly on the PCB (and not the star board).

# 26.5mm Holder location holes

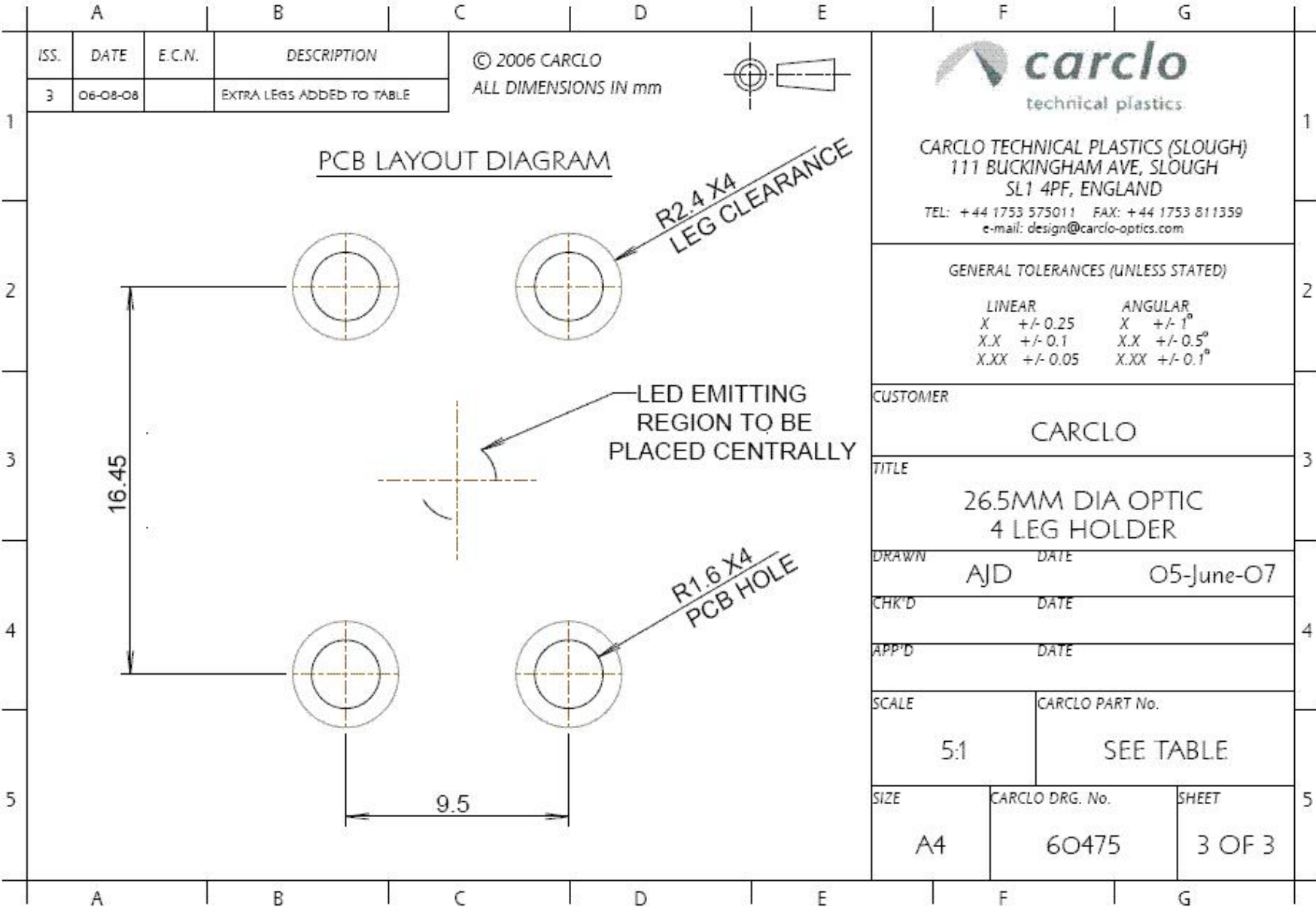



Компания «ЭлектроПласт» предлагает заключение долгосрочных отношений при поставках импортных электронных компонентов на взаимовыгодных условиях!

Наши преимущества:

- Оперативные поставки широкого спектра электронных компонентов отечественного и импортного производства напрямую от производителей и с крупнейших мировых складов;
- Поставка более 17-ти миллионов наименований электронных компонентов;
- Поставка сложных, дефицитных, либо снятых с производства позиций;
- Оперативные сроки поставки под заказ (от 5 рабочих дней);
- Экспресс доставка в любую точку России;
- Техническая поддержка проекта, помощь в подборе аналогов, поставка прототипов;
- Система менеджмента качества сертифицирована по Международному стандарту ISO 9001;
- Лицензия ФСБ на осуществление работ с использованием сведений, составляющих государственную тайну;
- Поставка специализированных компонентов (Xilinx, Altera, Analog Devices, Intersil, Interpoint, Microsemi, Aeroflex, Peregrine, Syfer, Eurofarad, Texas Instrument, Miteq, Cobham, E2V, MA-COM, Hittite, Mini-Circuits, General Dynamics и др.);

Помимо этого, одним из направлений компании «ЭлектроПласт» является направление «Источники питания». Мы предлагаем Вам помощь Конструкторского отдела:

- Подбор оптимального решения, техническое обоснование при выборе компонента;
- Подбор аналогов;
- Консультации по применению компонента;
- Поставка образцов и прототипов;
- Техническая поддержка проекта;
- Защита от снятия компонента с производства.



#### Как с нами связаться

**Телефон:** 8 (812) 309 58 32 (многоканальный)

**Факс:** 8 (812) 320-02-42

**Электронная почта:** [org@eplast1.ru](mailto:org@eplast1.ru)

**Адрес:** 198099, г. Санкт-Петербург, ул. Калинина, дом 2, корпус 4, литера А.