

Metal Oxide Resistors, Special Purpose, High Voltage



FEATURES

- Low TCR; ± 200 ppm/ $^{\circ}\text{C}$ standard; ± 100 ppm/ $^{\circ}\text{C}$, ± 50 ppm/ $^{\circ}\text{C}$ available
- Tolerance: $\pm 1\%$; $\pm 2\%$; $\pm 5\%$; $\pm 10\%$
- High Voltage (up to 45 kV)
- For oil bath or open air operation
- Matched sets available
- Special testing available upon request
- Material categorization:
For definitions of compliance please see www.vishay.com/doc?99912

RoHS*
 COMPLIANT

Note

* Lead (Pb)-containing terminations are not RoHS-compliant. Exemptions may apply.

STANDARD ELECTRICAL SPECIFICATIONS								
GLOBAL MODEL	HISTORICAL MODEL	POWER RATING			MAXIMUM WORKING VOLTAGE ⁽²⁾ V	RESISTANCE RANGE ⁽³⁾ Ω	TOLERANCE $\pm \%$	TEMPERATURE COEFFICIENT \pm ppm/ $^{\circ}\text{C}$
		$P_{25^{\circ}\text{C}}$ W ⁽¹⁾	$P_{70^{\circ}\text{C}}$ W ⁽¹⁾	$P_{125^{\circ}\text{C}}$ W ⁽¹⁾				
ROX050	ROX-1/2	2.0	1.4	1.0	2K	1M to 100M	1, 2, 5, 10	50
						1K to 100M	1, 2, 5, 10	100
						1K to 1G	1, 2, 5, 10	200
ROX075	ROX-3/4	3.0	2.16	1.5	5K	1M to 100M	1, 2, 5, 10	50
						1K to 500M	1, 2, 5, 10	100
						1K to 3G	1, 2, 5, 10	200
ROX100	ROX-1	4.0	2.88	2.0	7.5K	100 to 1M	1, 2, 5, 10	Non-inductive ⁽⁴⁾
						1M to 100M	1, 2, 5, 10	50
						1K to 500M	1, 2, 5, 10	100
ROX150	ROX-1-1/2	5.0	3.6	2.5	11K	1K to 3G	1, 2, 5, 10	200
						100 to 1M	1, 2, 5, 10	Non-inductive ⁽⁴⁾
						1M to 100M	1, 2, 5, 10	50
ROX200	ROX-2	6.0	4.32	3.0	15K	1K to 500M	1, 2, 5, 10	50
						1K to 1G	1, 2, 5, 10	100
						1K to 3G	1, 2, 5, 10	200
ROX300	ROX-3	10.0	7.2	5.0	22.5K	100 to 1M	1, 2, 5, 10	Non-inductive ⁽⁴⁾
						1M to 500M	1, 2, 5, 10	50
						1K to 1G	1, 2, 5, 10	100
ROX400	ROX-4	12.0	8.64	6.0	30K	1K to 3G	1, 2, 5, 10	200
						500 to 10M	1, 2, 5, 10	Non-inductive ⁽⁴⁾
						1M to 500M	1, 2, 5, 10	50
ROX500	ROX-5	16.0	11.52	8.0	37.5K	1K to 1G	1, 2, 5, 10	100
						1K to 3G	1, 2, 5, 10	200
						500 to 10M	1, 2, 5, 10	Non-inductive ⁽⁴⁾
ROX600	ROX-6	20.0	14.4	10.0	45K	1M to 500M	1, 2, 5, 10	50
						1K to 1G	1, 2, 5, 10	100
						1K to 3G	1, 2, 5, 10	200
						500 to 10M	1, 2, 5, 10	Non-inductive ⁽⁴⁾

Notes

- All resistance values are calibrated at 100 V_{DC}. Calibration at other voltages available.
- $\pm 1\%$ not available above 1 G Ω
- Part marking: Print marked - Dale, model, value, tolerance, temperature coefficient, date code
- (1) Increase wattage by 40 % for 0.040" (1.02 mm) diameter leads
- (2) Continuous working voltage shall be $\sqrt{P \times R}$ or maximum working voltage, whichever is less.
- (3) For resistance values above and below those listed please contact us
- (4) Non-inductive ± 200 ppm/ $^{\circ}\text{C}$ TCR only

TECHNICAL SPECIFICATIONS										
PARAMETER	UNIT	ROX050	ROX075	ROX100	ROX150	ROX200	ROX300	ROX400	ROX500	ROX600
Insulation Resistance	Ω	$\geq 10^{11}$								
Category Temperature Range	$^{\circ}\text{C}$	Epoxy coated = - 55/+ 180; Silicone coated = - 55/+ 230								

GLOBAL PART NUMBER INFORMATION

New Global Part Numbering: ROX300100MGNF5 (preferred part numbering format)

R O X 3 0 0 1 0 0 M G N F 5

GLOBAL MODEL (See Electrical Specifications table)	RESISTANCE VALUE R = Ω K = kΩ M = MΩ G = GΩ 910R = 910 Ω 10M0 = 10 MΩ 1G00 = 1.0 GΩ	TOLERANCE CODE F = ± 1 % G = ± 2 % J = ± 5 % K = ± 10 %	TEMP. COEFFICIENT H = 50 ppm K = 100 ppm N = 200 ppm	PACKAGING (1) EL = Lead (Pb)-free, lacer (all, except 3, 4, 5, 6) EE = Lead (Pb)-free, T/R (1/2, 3/4, 1 only) EM = Lead (Pb)-free, foam (3, 4, 5, 6 only) LB = Tin/lead, lacer (all, except 3, 4, 5, 6) RF = Tin/lead, T/R (1/2, 3/4, 1 only) F5 = Tin/lead, foam (3, 4, 5, 6 only)	CONSTRUCTION (Up to 2 digits) Blank = Standard N = Non-inductive P = 0.040 Ø leads S = Solid body, axial T = Threaded terminals Y = One end axial, one threaded terminal	SPECIAL Blank = Standard (Dash number) (Up to 3 digits) From 1 to 999 as applicable
---	--	---	---	---	---	--

Historical Part Number example: ROX-3100MGN (will continue to be accepted)

ROX-3		100M	G	N	F05
HISTORICAL MODEL	CONSTRUCTION	RESISTANCE VALUE	TOLERANCE CODE	TEMP. COEFFICIENT	PACKAGING

Notes

(1) Some packaging codes are model specific.

- For additional information on packaging, refer to the Through-Hole Resistor Packaging document (www.vishay.com/doc?31544).

DIMENSIONS in inches (millimeters)

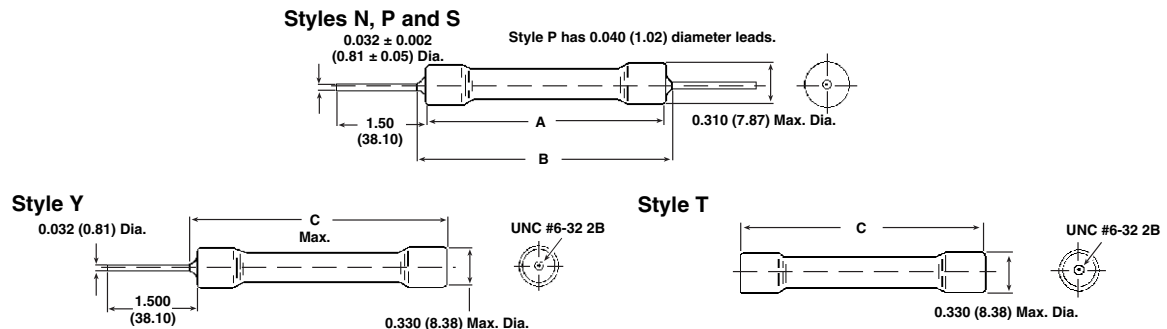

GLOBAL MODEL	STYLE N, P, S		STYLE T	STYLE Y
	A	B	C	C MAX.
ROX050	0.550 ± 0.032 (13.97 ± 0.81)	0.700 (17.78)	N/A	N/A
ROX075	0.800 ± 0.032 (20.32 ± 0.81)	0.900 (22.86)	1.168 ± 0.022 (29.66 ± 0.56)	1.050 (26.67)
ROX100	0.920 ± 0.032 (23.37 ± 0.81)	1.020 (25.91)	1.288 ± 0.022 (32.72 ± 0.56)	1.170 (29.72)
ROX150	1.550 ± 0.032 (39.37 ± 0.81)	1.650 (41.91)	1.918 ± 0.022 (48.72 ± 0.56)	1.800 (45.72)
ROX200	2.050 ± 0.032 (52.07 ± 0.81)	2.150 (54.61)	2.418 ± 0.022 (61.42 ± 0.56)	2.300 (58.42)
ROX300	3.050 ± 0.032 (77.47 ± 0.81)	3.150 (80.01)	3.418 ± 0.022 (86.82 ± 0.56)	3.300 (83.82)
ROX400	4.050 ± 0.032 (102.87 ± 0.81)	4.150 (105.41)	4.418 ± 0.022 (112.22 ± 0.56)	4.300 (109.22)
ROX500	5.050 ± 0.032 (128.27 ± 0.81)	5.150 (130.81)	5.418 ± 0.022 (137.62 ± 0.56)	5.300 (134.62)
ROX600	6.050 ± 0.032 (153.67 ± 0.81)	6.150 (156.21)	6.418 ± 0.022 (163.02 ± 0.56)	6.300 (160.02)

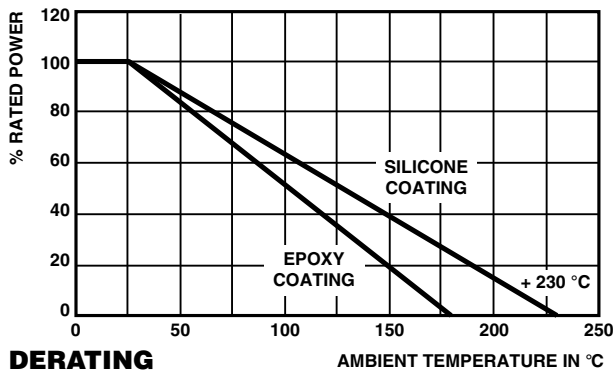

MECHANICAL SPECIFICATIONS

Terminal Strength	10 pound pull test
Solderability	Continuous satisfactory coverage when tested in accordance with MIL-STD-202, Method 208

MATERIAL SPECIFICATIONS

Element	High temperature fired cermet film
Core	High purity 96 % alumina, tubular or solid
Coating	Blue flame-retardant epoxy on ROX050 thru ROX200. Black flameproof silicone on ROX300 thru ROX600
Termination	Standard lead material is solder-coated copper; solderable and weldable. 0.032" (0.813 mm) style P 0.040" (1.02 mm) available





Disclaimer

ALL PRODUCT, PRODUCT SPECIFICATIONS AND DATA ARE SUBJECT TO CHANGE WITHOUT NOTICE TO IMPROVE RELIABILITY, FUNCTION OR DESIGN OR OTHERWISE.

Vishay Intertechnology, Inc., its affiliates, agents, and employees, and all persons acting on its or their behalf (collectively, "Vishay"), disclaim any and all liability for any errors, inaccuracies or incompleteness contained in any datasheet or in any other disclosure relating to any product.

Vishay makes no warranty, representation or guarantee regarding the suitability of the products for any particular purpose or the continuing production of any product. To the maximum extent permitted by applicable law, Vishay disclaims (i) any and all liability arising out of the application or use of any product, (ii) any and all liability, including without limitation special, consequential or incidental damages, and (iii) any and all implied warranties, including warranties of fitness for particular purpose, non-infringement and merchantability.

Statements regarding the suitability of products for certain types of applications are based on Vishay's knowledge of typical requirements that are often placed on Vishay products in generic applications. Such statements are not binding statements about the suitability of products for a particular application. It is the customer's responsibility to validate that a particular product with the properties described in the product specification is suitable for use in a particular application. Parameters provided in datasheets and/or specifications may vary in different applications and performance may vary over time. All operating parameters, including typical parameters, must be validated for each customer application by the customer's technical experts. Product specifications do not expand or otherwise modify Vishay's terms and conditions of purchase, including but not limited to the warranty expressed therein.

Except as expressly indicated in writing, Vishay products are not designed for use in medical, life-saving, or life-sustaining applications or for any other application in which the failure of the Vishay product could result in personal injury or death. Customers using or selling Vishay products not expressly indicated for use in such applications do so at their own risk. Please contact authorized Vishay personnel to obtain written terms and conditions regarding products designed for such applications.

No license, express or implied, by estoppel or otherwise, to any intellectual property rights is granted by this document or by any conduct of Vishay. Product names and markings noted herein may be trademarks of their respective owners.

Material Category Policy

Vishay Intertechnology, Inc. hereby certifies that all its products that are identified as RoHS-Compliant fulfill the definitions and restrictions defined under Directive 2011/65/EU of The European Parliament and of the Council of June 8, 2011 on the restriction of the use of certain hazardous substances in electrical and electronic equipment (EEE) - recast, unless otherwise specified as non-compliant.

Please note that some Vishay documentation may still make reference to RoHS Directive 2002/95/EC. We confirm that all the products identified as being compliant to Directive 2002/95/EC conform to Directive 2011/65/EU.

Vishay Intertechnology, Inc. hereby certifies that all its products that are identified as Halogen-Free follow Halogen-Free requirements as per JEDEC JS709A standards. Please note that some Vishay documentation may still make reference to the IEC 61249-2-21 definition. We confirm that all the products identified as being compliant to IEC 61249-2-21 conform to JEDEC JS709A standards.



Компания «ЭлектроПласт» предлагает заключение долгосрочных отношений при поставках импортных электронных компонентов на взаимовыгодных условиях!

Наши преимущества:

- Оперативные поставки широкого спектра электронных компонентов отечественного и импортного производства напрямую от производителей и с крупнейших мировых складов;
- Поставка более 17-ти миллионов наименований электронных компонентов;
- Поставка сложных, дефицитных, либо снятых с производства позиций;
- Оперативные сроки поставки под заказ (от 5 рабочих дней);
- Экспресс доставка в любую точку России;
- Техническая поддержка проекта, помощь в подборе аналогов, поставка прототипов;
- Система менеджмента качества сертифицирована по Международному стандарту ISO 9001;
- Лицензия ФСБ на осуществление работ с использованием сведений, составляющих государственную тайну;
- Поставка специализированных компонентов (Xilinx, Altera, Analog Devices, Intersil, Interpoint, Microsemi, Aeroflex, Peregrine, Syfer, Eurofarad, Texas Instrument, Miteq, Cobham, E2V, MA-COM, Hittite, Mini-Circuits, General Dynamics и др.);

Помимо этого, одним из направлений компании «ЭлектроПласт» является направление «Источники питания». Мы предлагаем Вам помощь Конструкторского отдела:

- Подбор оптимального решения, техническое обоснование при выборе компонента;
- Подбор аналогов;
- Консультации по применению компонента;
- Поставка образцов и прототипов;
- Техническая поддержка проекта;
- Защита от снятия компонента с производства.



Как с нами связаться

Телефон: 8 (812) 309 58 32 (многоканальный)

Факс: 8 (812) 320-02-42

Электронная почта: org@eplast1.ru

Адрес: 198099, г. Санкт-Петербург, ул. Калинина, дом 2, корпус 4, литера А.