

TRANSIENT VOLTAGE SUPPRESSOR

VRD

VRD is a transient voltage suppressor used for protecting electric circuits from surge voltage and thus preventing breakdown.

VRD has superior surge suppression characteristics, such as extremely fast response time, very low clamping voltage, and high surge capacity. Unlike metal oxide varistors, VRD does not have characteristics to change with surge variations within the rated capacity. This feature comprises another superior characteristics of the VRD as a transient voltage suppressors.



Part number

Z2 033 U - 52Z	52Z : Axial tapping winding type
	52R : Axial tapping relay type
	FT : Radial form tapping type
	Nil : individually packed in a bag
	U : Uni-Polar
	Nil : Bi-Polar
	Break down voltage
	Type
	Z2 : Rated electricity 1.0W
	Z6 : Rated electricity 2.0W
	ZD : Rated electricity 0.5W (reverse blocking type)

Electrical characteristics

Figure 1 shows the electrical characteristics. Bipolar type has almost symmetrical breakdown Voltage (V_B) The reverse breakdown voltage of the ZD type is 200 Volts or more at $10\mu A$ DC.

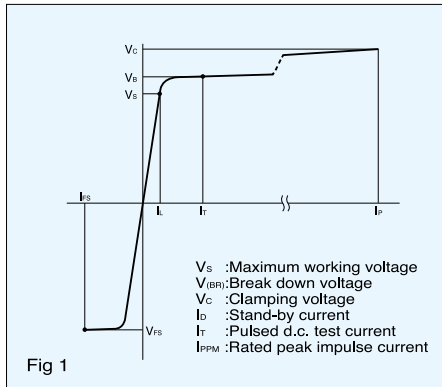

Fig 1

Taping

One of standard taping is as shown in Figure.

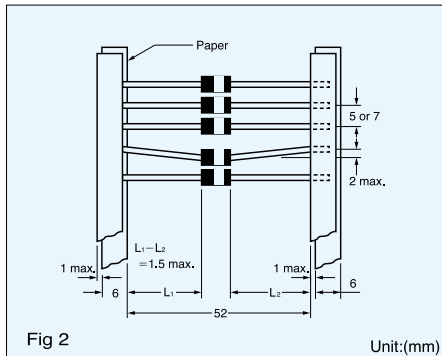

Fig 2

Unit:(mm)

Taping qty

Part series	Taping method	Qty(pcs)	
Z2,Z2U	Axial tapping	reel type	5,000
		winding type	2,000
	Radial tapping	winding type	2,000
Z6,Z6U	Axial tapping	reel type	2,500
		winding type	1,000

Surge capability

Allowable surge capability (P_{PPM}) is determined by the following equation:

$$P_{PPM} = I_{PPM} \times V_C$$

I_{PPM} : Rated peak impulse current

V_C : clamping voltage

The allowable surge capability (Rated peak impulse power dissipation P_{PPM}) of VRD is shown in following Figure 3 and the surge capability derating characteristics are shown in Figure 6.

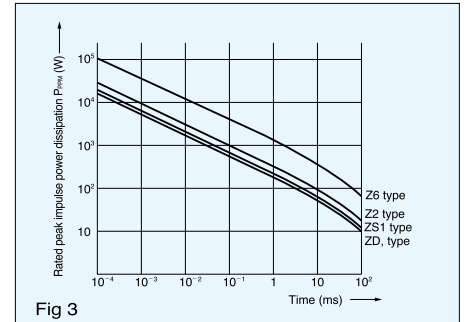

Fig 3

Surge waveform

There are many types of surge waveform depending on the source of the surge. For the VRD surge suppression characteristics test, the EXP waveform shown below is used. The EXP waveform is shown as t_a/t_b depending on the time width, however 10/1000 waveform is used as the standard test waveform.

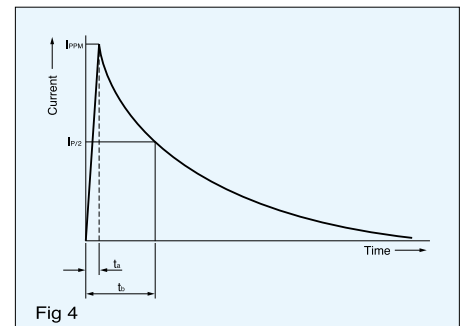

Fig 4

Surge suppression characteristics

When EXP waveform is applied, the surge suppression waveform shown in the figure 5 can be observed.



Power derating



Z2 type VRD has bipolar or unipolar electrical characteristics.

Maximum ratings

Rated peak impulse power dissipation
:500 W (10/1000 μ s)
6.00 kW (8/20 μ s)

Rated average power dissipation:1W
Operating and storage temperature
: -40°C to 125°C

Symbol mark



Part No.		Stand-off voltage V_s V	Stand-by current I_b μ A	Breakdown voltage $V_{(BR)}$ V	Pulsed d.c. test current I_T mA	Clamping Voltage & Rated peak impulse current				Temperature coefficient (TYP)	Capacitance (TYP) pF
Bi-polar type	Uni-polar type					10/1000 μ s		8/20 μ s			
						V_C V	I_{PPM} A	V_C V	I_{PPM} A		
-	Z2008U	6.63	500	7.38-9.02	10	12.5	40.0	16.3	372	0.063	2400
-	Z2010U	8.10	20	9.00-11.0		15.0	33.4	19.5	311	0.071	1900
Z2012	-	9.72		10.8-13.2		17.3	28.9	22.7	267	0.066	790
-	Z2012U			10.8-13.2						0.074	1580
Z2015	-	12.1		13.5-16.5		22.0	22.7	28.4	213	0.075	640
-	Z2015U			13.5-16.5						0.079	1280
Z2018	-	14.5		16.2-19.8		26.5	18.8	34.0	178	0.079	520
-	Z2018U			16.2-19.8						0.083	1040
Z2022	-	17.8		19.8-24.2		31.9	15.7	41.2	147	0.082	420
-	Z2022U			19.8-24.2						0.086	840
Z2027	-	21.8		24.3-29.7		39.1	12.8	50.5	120	0.085	340
-	Z2027U			24.3-29.7						0.089	680
Z2033	-	26.8		29.7-36.3		47.7	10.5	61.7	98.2	0.087	280
-	Z2033U			29.7-36.3						0.092	560
Z2039	-	31.6		35.1-42.9		56.4	8.86	73.0	83.0	0.090	240
-	Z2039U			35.1-42.9						0.095	480
Z2047	-	38.1	5	42.3-51.7	1	67.8	7.37	88.0	68.9	0.092	200
-	Z2047U			42.3-51.7						0.097	400
Z2056	-	45.4		50.4-61.6		80.5	6.21	105.0	57.7	0.094	160
-	Z2056U			50.4-61.6						0.099	320
Z2068	-	55.1		61.2-74.8		98.0	5.10	127.0	47.7	0.096	130
-	Z2068U			61.2-74.8						0.100	260
Z2082	-	66.4		73.8-90.2		118.0	4.24	153.0	39.6	0.099	110
-	Z2082U			73.8-90.2						0.102	220
Z2100	-	81.0		90.0-110		144.0	3.47	187.0	32.4	0.101	90
-	Z2100U			90.0-110						0.104	180
Z2120	-	97.2		108-132		173.0	2.89	222.0	27.3	0.103	75
-	Z2120U			108-132						0.106	150
Z2150	-	121.0		135-165		215.0	2.32	277.0	21.9	0.105	60
-	Z2150U			135-165						0.107	120
Z2180	-	146.0		162-198		258.0	1.94	333.0	18.2	0.106	49
-	Z2180U			162-198						0.108	98

NOTE: Nonsuffix:bi-polar, suffix"U" : uni-polar.

Part No.		Stand-off voltage V _s V	Stand-by current I _b μA	Breakdown voltage V _(BR) V	Pulsed d.c. test current I _T mA	Clamping Voltage & Rated peak impulse current				Max. temp. coef. %/°C	Capacitance (TYP) pF																																												
Bi-polar type	Uni-polar type					10/1000μs		8/20μs																																															
						V _C V	I _{PPM} A	V _C V	I _{PPM} A																																														
Z6012	-	9.72	10	10.8-13.2	1	17.3	86.7	22.7	802	0.066	4400																																												
-	Z6012U			10.8-13.2						0.074	8800																																												
Z6015	-	12.1	10	13.5-16.5						22.0	68.2	28.4	641	0.075	3300																																								
-	Z6015U			13.5-16.5						0.079	6600																																												
Z6018	-	14.5	10	16.2-19.8						1	26.5	56.6	34.0	535	0.079	2700																																							
-	Z6018U			16.2-19.8											0.083	5400																																							
Z6022	-	17.8	10	19.8-24.2											31.9	47.0	41.2	442	0.082	2400																																			
-	Z6022U			19.8-24.2											0.086	4400																																							
Z6027	-	21.8	10	24.3-29.7											1	39.1	38.4	50.5	360	0.085	1700																																		
-	Z6027U			24.3-29.7																0.089	3300																																		
Z6033	-	26.8	5	29.7-36.3																1	47.7	31.4	61.7	295	0.087	1400																													
-	Z6033U			29.7-36.3																					0.092	2800																													
Z6039	-	31.6	5	35.1-42.9																					1	56.4	26.6	73.0	249	0.090	1200																								
-	Z6039U			35.1-42.9																										0.095	2400																								
Z6047	-	38.1	5	42.3-51.7																										1	67.8	22.1	88.0	207	0.092	1000																			
-	Z6047U			42.3-51.7																															0.097	2000																			
Z6056	-	45.4	5	50.4-61.6																															1	80.5	18.6	105.0	173	0.094	850														
-	Z6056U			50.4-61.6																																				0.099	1700														
Z6068	-	55.1	5	61.2-74.8																																				1	98.0	15.3	127.0	143	0.096	720									
-	Z6068U			61.2-74.8																																									0.100	1440									
Z6082	-	66.4	5	73.8-90.2	1	118.0	12.7	153.0	119																																				0.099	610									
-	Z6082U			73.8-90.2																																									0.102	1220									
Z6100	-	81.0	5	90.0-110																																									1	144.0	10.4	187.0	97.3	0.101	520				
-	Z6100U			90.0-110																																														0.104	1040				
Z6120	-	97.2	5	108-132						1	173.0	8.67	222.0	82.0																																				0.103	440				
-	Z6120U			108-132																																														0.106	880				
-	Z6150U	121.0	5	135-165																																														215.0	6.98	277.0	65.7	0.107	720

NOTE : Nonsuffix : Bi-polar, suffix "U" : Uni-polar.

Z6 type VRD has bipolar or unipolar electrical characteristics.

Maximum ratings
 Rated peak impulse power dissipation :1.5kW(10/1000μs)
 18.0kW(8/20μs)
 Rated average power dissipation:2W
 Operating and storage temperature : -40°C to 125°C

Symbol mark

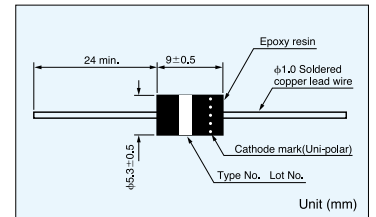
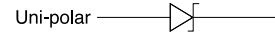

VRD part No.	Stand-off voltage V _s V	Stand-by current I _b μA	Breakdown voltage V _(BR) V	Pulsed d.c. test current I _T mA	Clamping Voltage & Rated peak impulse current				Max. temp. coef. %/°C	Capacitance (TYP) pF						
					10/1000μs		8/20μs									
					V _C V	I _{PPM} A	V _C V	I _{PPM} A								
ZD015	11.4	10	12.8-17.2	1	24.0	10.4	31.0	96.7	0.075	31.5						
ZD018	13.7		15.3-20.7								28.0	8.93	36.0	83.3	0.079	31.0
ZD022	16.8	5	18.7-25.3								33.2	7.53	43.0	69.7	0.082	29.0
ZD027	20.6		23.0-31.0								40.0	6.25	52.0	57.7	0.085	28.2
ZD033	25.2	5	28.1-37.9								48.6	5.14	63.0	47.6	0.087	27.2
ZD039	29.8		33.2-44.8								57.4	4.35	74.0	40.5	0.090	26.3
ZD047	35.9	5	40.0-54.0								68.5	3.65	89.0	33.7	0.092	25.0
ZD056	42.8		47.6-64.4								81.0	3.08	106.0	28.6	0.094	24.1
ZD068	52.0	5	57.8-78.2								98.0	2.55	127.0	23.8	0.096	22.0

Low capacitance type

Maximum ratings
 Reverse voltage:200 VDC
 Rated peak impulse power dissipation :250 W(10/1000μs)
 3.00 kW(8/20μs)
 Rated average power dissipation:500 mW
 Operating and storage temperature : -40°C to 125°C

Symbol mark

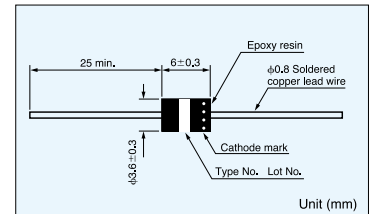

SMD VRD

Part number



Dimensions



Marking



	Rating
Rated average power dissipation	1.0W
Rated peak impulse power dissipation	300W(10/1000 μ s)
	1200W(1.2/50 μ s)
	2000W(8/20 μ s)
Storage temp. range	-40°C~150°C

Taping



A	B	W	F	E	P ₁
3.0 ±0.1	5.2 ±0.1	12.0 ±0.3	5.5 ±0.05	1.75 ±0.1	4.0 ±0.1
P ₂	P ₀	phi D ₀	phi D ₁	T ₁	T ₂
2.0 ±0.1	4.0 ±0.1	1.5 +0.1 -0	1.5 +0.2 -0	0.3 ±0.05	(2.6)

Unit (mm)

Specifications

ZS type

Part No.	Breakdown voltage	Stand-off voltage	Stand-by current	Maximum clamping voltage & Maximum peak pulse current				Temperature coefficient (TYP)	Capacitance (TYP)		
				V _{Cmax} /I _{PPM}						25°C~50°C	C
				10/1000 μ s		8/20 μ s					
				V	A	V	A				
ZS1012	12(10.8~13.2)	9.72	10	17.3	17.3	22.4	89.3	0.066	551		
ZS1015	15(13.5~16.5)	12.1	5	22.0	13.6	28.5	70.2	0.075	465		
ZS1018	18(16.2~19.8)	14.5		26.5	11.3	34.4	58.1	0.079	376		
ZS1022	22(19.8~24.2)	17.8		31.9	9.40	41.4	48.3	0.082	299		
ZS1027	27(24.3~29.7)	21.8		39.1	7.67	50.7	39.4	0.085	248		
ZS1033	33(29.7~36.3)	26.8		47.7	6.29	61.8	32.4	0.087	198		
ZS1039	39(35.1~42.9)	31.6		56.4	5.32	73.1	27.4	0.090	164		
ZS1047	47(42.3~51.7)	38.1		67.8	4.42	88.0	22.7	0.092	137		

ZS-U type

Part No.	Breakdown voltage	Stand-off voltage	Stand-by current	Maximum clamping voltage & Maximum peak pulse current				Temperature coefficient (TYP)	Capacitance (TYP)		
				V _{Cmax} /I _{PPM}						25°C~50°C	C
				10/1000 μ s		8/20 μ s					
				V	A	V	A				
ZS1012U	12(10.8~13.2)	9.72	10	17.3	17.3	22.4	89.3	0.066	1,102		
ZS1015U	15(13.5~16.5)	12.1	5	22.0	13.6	28.5	70.2	0.075	929		
ZS1018U	18(16.2~19.8)	14.5		26.5	11.3	34.4	58.1	0.079	751		
ZS1022U	22(19.8~24.2)	17.8		31.9	9.40	41.4	48.3	0.082	598		
ZS1027U	27(24.3~29.7)	21.8		39.1	7.67	50.7	39.4	0.085	497		
ZS1033U	33(29.7~36.3)	26.8		47.7	6.29	61.8	32.4	0.087	395		
ZS1039U	39(35.1~42.9)	31.6		56.4	5.32	73.1	27.4	0.090	328		
ZS1047U	47(42.3~51.7)	38.1		67.8	4.42	88.0	22.7	0.092	274		

ZS-D type

Part No.	Breakdown voltage	Stand-off voltage	Stand-by current	Maximum clamping voltage & Maximum peak pulse current				Temperature coefficient (TYP)	Capacitance (TYP)		
				V _{Cmax} /I _{PPM}						25°C~50°C	C
				10/1000 μ s		8/20 μ s					
				V	A	V	A				
ZS1012D	12(10.8~13.2)	9.72	10	17.3	17.3	22.4	89.3	0.066	30.2		
ZS1015D	15(13.5~16.5)	12.1	5	22.0	13.6	28.5	70.2	0.075	29.1		
ZS1018D	18(16.2~19.8)	14.5		26.5	11.3	34.4	58.1	0.079	28.2		
ZS1022D	22(19.8~24.2)	17.8		31.9	9.40	41.4	48.3	0.082	27.3		
ZS1027D	27(24.3~29.7)	21.8		39.1	7.67	50.7	39.4	0.085	26.4		
ZS1033D	33(29.7~36.3)	26.8		47.7	6.29	61.8	32.4	0.087	25.5		
ZS1039D	39(35.1~42.9)	31.6		56.4	5.32	73.1	27.4	0.090	24.8		
ZS1047D	47(42.3~51.7)	38.1		67.8	4.42	88.0	22.7	0.092	24.0		



Компания «ЭлектроПласт» предлагает заключение долгосрочных отношений при поставках импортных электронных компонентов на взаимовыгодных условиях!

Наши преимущества:

- Оперативные поставки широкого спектра электронных компонентов отечественного и импортного производства напрямую от производителей и с крупнейших мировых складов;
- Поставка более 17-ти миллионов наименований электронных компонентов;
- Поставка сложных, дефицитных, либо снятых с производства позиций;
- Оперативные сроки поставки под заказ (от 5 рабочих дней);
- Экспресс доставка в любую точку России;
- Техническая поддержка проекта, помощь в подборе аналогов, поставка прототипов;
- Система менеджмента качества сертифицирована по Международному стандарту ISO 9001;
- Лицензия ФСБ на осуществление работ с использованием сведений, составляющих государственную тайну;
- Поставка специализированных компонентов (Xilinx, Altera, Analog Devices, Intersil, Interpoint, Microsemi, Aeroflex, Peregrine, Syfer, Eurofarad, Texas Instrument, Miteq, Cobham, E2V, MA-COM, Hittite, Mini-Circuits, General Dynamics и др.);

Помимо этого, одним из направлений компании «ЭлектроПласт» является направление «Источники питания». Мы предлагаем Вам помощь Конструкторского отдела:

- Подбор оптимального решения, техническое обоснование при выборе компонента;
- Подбор аналогов;
- Консультации по применению компонента;
- Поставка образцов и прототипов;
- Техническая поддержка проекта;
- Защита от снятия компонента с производства.



Как с нами связаться

Телефон: 8 (812) 309 58 32 (многоканальный)

Факс: 8 (812) 320-02-42

Электронная почта: org@eplast1.ru

Адрес: 198099, г. Санкт-Петербург, ул. Калинина, дом 2, корпус 4, литера А.