

Complementary power Darlingtons

Features

- Low collector-emitter saturation voltage
- Integrated antiparallel collector-emitter diode

Applications

- General purpose linear and switching

Description

The devices are manufactured in planar technology with “base island” layout and monolithic Darlingtons configuration. The resulting transistors show exceptional high gain performance coupled with very low saturation voltage.

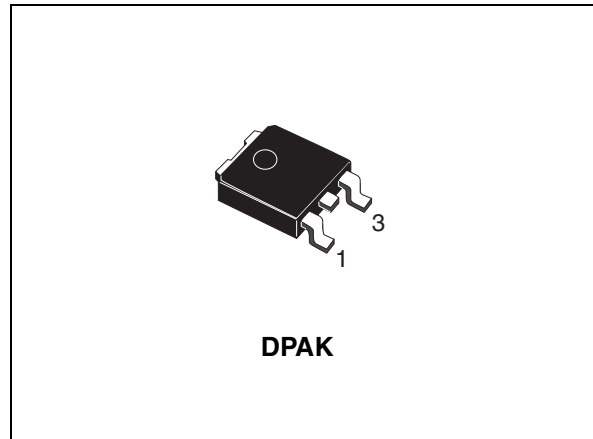

Figure 1. Internal schematic diagrams

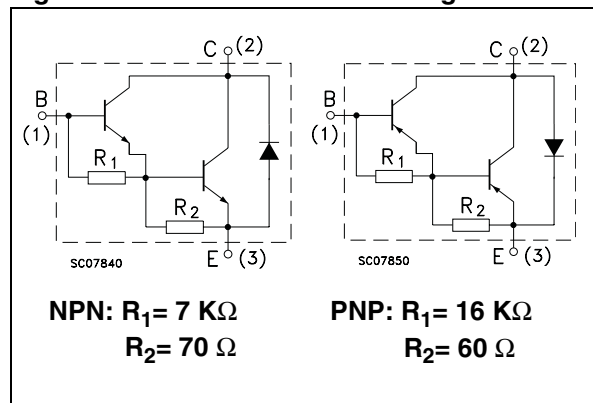

Table 1. Device summary

Order codes	Marking	Polarity	Package	Packaging
MJD122T4	MJD122	NPN	DPAK	Tape and reel
MJD127T4	MJD127	PNP		

Content

1	Electrical ratings	3
2	Electrical characteristics	4
	2.1 Electrical characteristics (curves)	5
3	Test circuits	8
4	Package mechanical data	9
5	Revision history	11

1 Electrical ratings

Table 2. Absolute maximum ratings

Symbol	Parameter	Value	Unit
V_{CBO}	Collector-base voltage ($I_E = 0$)	100	V
V_{CEO}	Collector-emitter voltage ($I_B = 0$)	100	V
V_{EBO}	Emitter-base voltage ($I_C = 0$)	5	V
I_C	Collector current	8	A
I_{CM}	Collector peak current	16	A
I_B	Base current	0.12	A
P_{TOT}	Total dissipation at $T_{case} = 25^\circ\text{C}$	20	W
T_{stg}	Storage temperature	-65 to 150	$^\circ\text{C}$
T_J	Max. operating junction temperature	150	$^\circ\text{C}$

Note: For PNP types voltage and current values are negative.

Table 3. Thermal data

Symbol	Parameter	Value	Unit
R_{thj-c}	Thermal resistance junction-case max.	6.25	$^\circ\text{C}/\text{W}$

2 Electrical characteristics

($T_{\text{case}} = 25\text{ °C}$; unless otherwise specified)

Table 4. Electrical characteristics

Symbol	Parameter	Test conditions	Min.	Typ.	Max.	Unit
I_{CBO}	Collector cut-off current ($I_{\text{E}} = 0$)	$V_{\text{CB}} = 100\text{ V}$		-	10	μA
I_{CEO}	Collector cut-off current ($I_{\text{B}} = 0$)	$V_{\text{CE}} = 50\text{ V}$		-	10	μA
I_{EBO}	Emitter cut-off current ($I_{\text{C}} = 0$)	$V_{\text{EB}} = 5\text{ V}$		-	2	mA
$V_{\text{CEO(sus)}}^{(1)}$	Collector-emitter sustaining voltage ($I_{\text{B}} = 0$)	$I_{\text{C}} = 30\text{ mA}$	100	-		V
$V_{\text{CE(sat)}}^{(1)}$	Collector-emitter saturation voltage	$I_{\text{C}} = 4\text{ A}$ $I_{\text{B}} = 16\text{ mA}$		-	2	V
		$I_{\text{C}} = 8\text{ A}$ $I_{\text{B}} = 80\text{ mA}$			4	V
$V_{\text{BE(sat)}}^{(1)}$	Base-emitter saturation voltage	$I_{\text{C}} = 8\text{ A}$ $I_{\text{B}} = 80\text{ mA}$		-	4.5	V
$V_{\text{BE(on)}}^{(1)}$	Base-emitter on voltage	$I_{\text{C}} = 4\text{ A}$ $V_{\text{CE}} = 4\text{ V}$		-	2.8	V
$h_{\text{FE}}^{(1)}$	DC current gain	$I_{\text{C}} = 4\text{ A}$ $V_{\text{CE}} = 4\text{ V}$	1000	-	12000	
		$I_{\text{C}} = 8\text{ A}$ $V_{\text{CE}} = 4\text{ V}$	100			

1. Pulsed duration = 300 μs , duty cycle $\leq 1.5\%$

Note: For PNP types voltage and current values are negative.

2.1 Electrical characteristics (curves)

Figure 2. Safe operating area

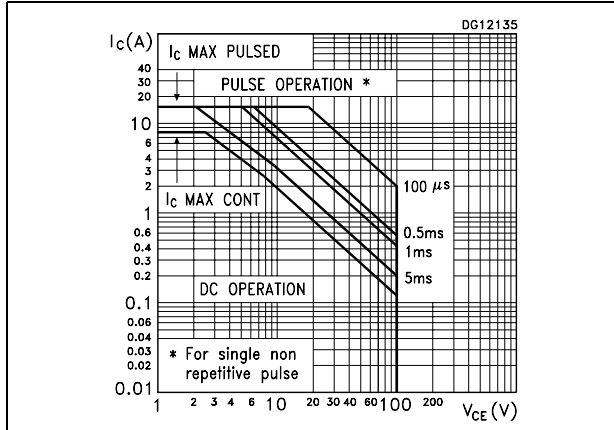

Figure 3. Derating curve

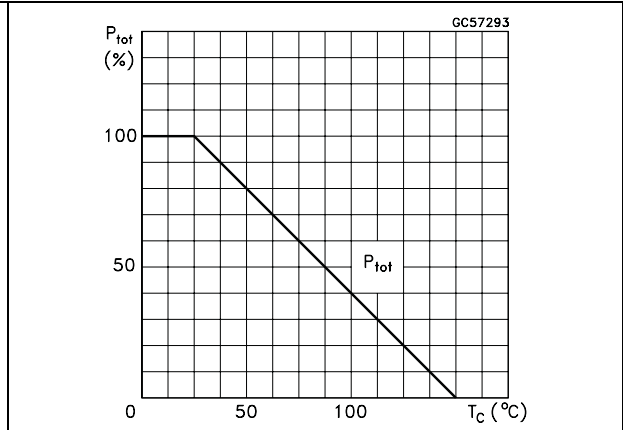

Figure 4. DC current gain for NPN type



Figure 5. DC current gain for PNP type

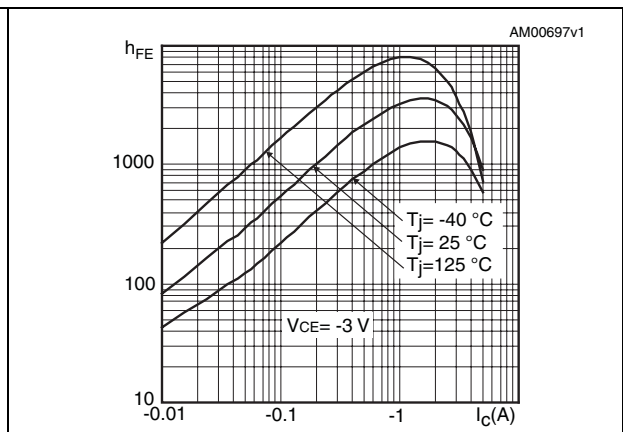

Figure 6. Collector-emitter saturation voltage for NPN type

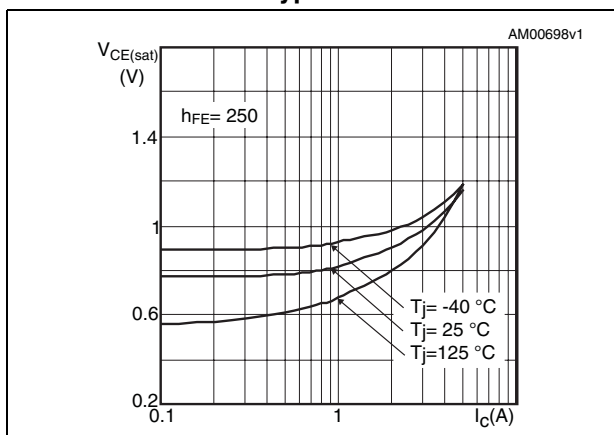

Figure 7. Collector-emitter saturation voltage for PNP type

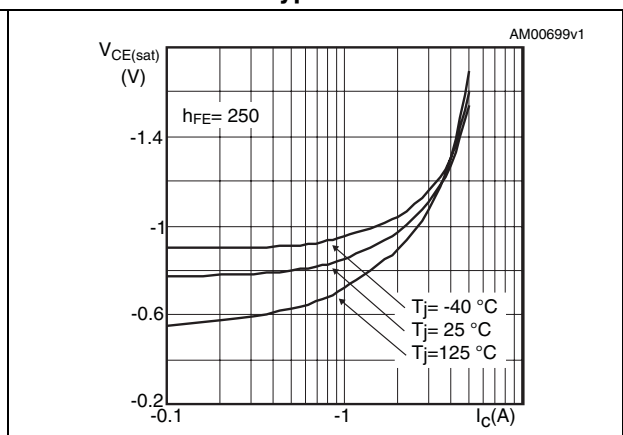

Figure 8. Base-emitter saturation voltage for NPN type



Figure 9. Base-emitter saturation voltage for PNP type



Figure 10. Base-emitter on voltage for NPN type



Figure 11. Base-emitter on voltage for PNP type



Figure 12. Resistive load switching times for NPN type (on)



Figure 13. Resistive load switching times for PNP type (on)



Figure 14. Resistive load switching times for NPN type (off)

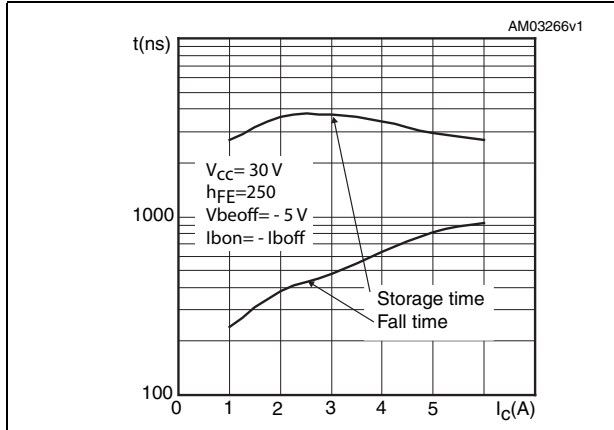

Figure 15. Resistive load switching times for PNP type (off)

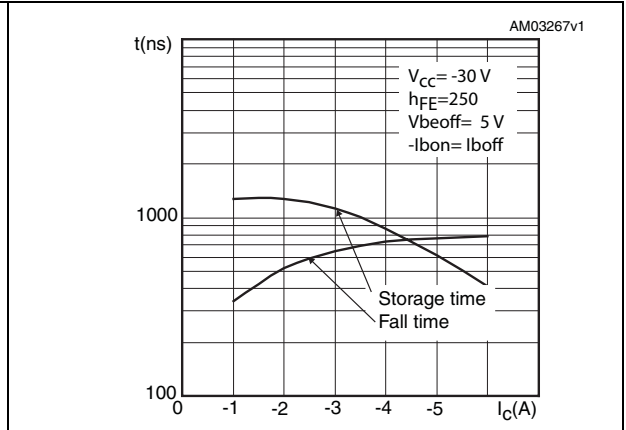

Figure 16. Capacitances for NPN type

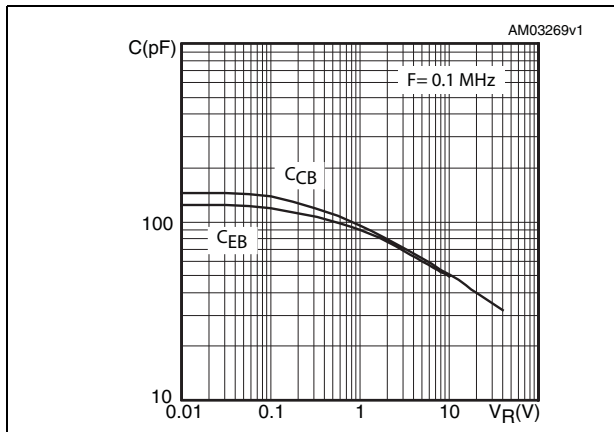
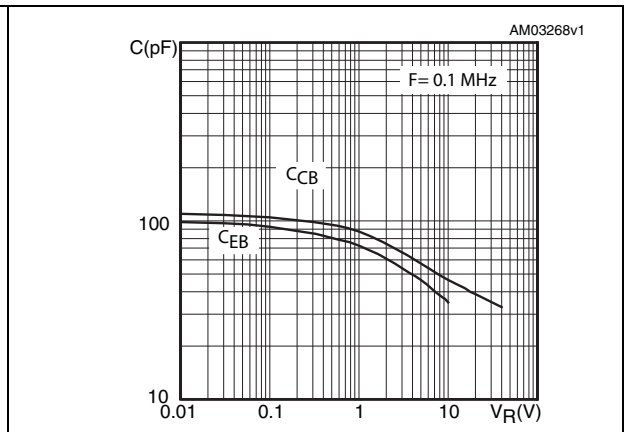

Figure 17. Capacitances for PNP type



3 Test circuits

Figure 18. Resistive load switching for NPN type



- 1. Fast electronic switch
- 2. Non-inductive resistor

Figure 19. Resistive load switching for PNP type



- 1. Fast electronic switch
- 2. Non-inductive resistor

4 Package mechanical data

In order to meet environmental requirements, ST offers these devices in different grades of ECOPACK® packages, depending on their level of environmental compliance. ECOPACK® specifications, grade definitions and product status are available at: www.st.com. ECOPACK is an ST trademark.

TO-252 (DPAK) mechanical data

DIM.	mm.		
	min.	typ	max.
A	2.20		2.40
A1	0.90		1.10
A2	0.03		0.23
b	0.64		0.90
b4	5.20		5.40
c	0.45		0.60
c2	0.48		0.60
D	6.00		6.20
D1		5.10	
E	6.40		6.60
E1		4.70	
e		2.28	
e1	4.40		4.60
H	9.35		10.10
L	1		
L1		2.80	
L2		0.80	
L4	0.60		1
R		0.20	
V2	0°		8°



5 Revision history

Table 5. Document revision history

Date	Revision	Changes
01-Aug-2002	8	
01-Oct-2007	9	Collector current limits have been improved
03-Oct-2007	10	Package mechanical data updated
21-Apr-2009	11	The device MJD127 has been inserted Section 2.1: Electrical characteristics (curves) has been updated

Please Read Carefully:

Information in this document is provided solely in connection with ST products. STMicroelectronics NV and its subsidiaries ("ST") reserve the right to make changes, corrections, modifications or improvements, to this document, and the products and services described herein at any time, without notice.

All ST products are sold pursuant to ST's terms and conditions of sale.

Purchasers are solely responsible for the choice, selection and use of the ST products and services described herein, and ST assumes no liability whatsoever relating to the choice, selection or use of the ST products and services described herein.

No license, express or implied, by estoppel or otherwise, to any intellectual property rights is granted under this document. If any part of this document refers to any third party products or services it shall not be deemed a license grant by ST for the use of such third party products or services, or any intellectual property contained therein or considered as a warranty covering the use in any manner whatsoever of such third party products or services or any intellectual property contained therein.

UNLESS OTHERWISE SET FORTH IN ST'S TERMS AND CONDITIONS OF SALE ST DISCLAIMS ANY EXPRESS OR IMPLIED WARRANTY WITH RESPECT TO THE USE AND/OR SALE OF ST PRODUCTS INCLUDING WITHOUT LIMITATION IMPLIED WARRANTIES OF MERCHANTABILITY, FITNESS FOR A PARTICULAR PURPOSE (AND THEIR EQUIVALENTS UNDER THE LAWS OF ANY JURISDICTION), OR INFRINGEMENT OF ANY PATENT, COPYRIGHT OR OTHER INTELLECTUAL PROPERTY RIGHT.

UNLESS EXPRESSLY APPROVED IN WRITING BY AN AUTHORIZED ST REPRESENTATIVE, ST PRODUCTS ARE NOT RECOMMENDED, AUTHORIZED OR WARRANTED FOR USE IN MILITARY, AIR CRAFT, SPACE, LIFE SAVING, OR LIFE SUSTAINING APPLICATIONS, NOR IN PRODUCTS OR SYSTEMS WHERE FAILURE OR MALFUNCTION MAY RESULT IN PERSONAL INJURY, DEATH, OR SEVERE PROPERTY OR ENVIRONMENTAL DAMAGE. ST PRODUCTS WHICH ARE NOT SPECIFIED AS "AUTOMOTIVE GRADE" MAY ONLY BE USED IN AUTOMOTIVE APPLICATIONS AT USER'S OWN RISK.

Resale of ST products with provisions different from the statements and/or technical features set forth in this document shall immediately void any warranty granted by ST for the ST product or service described herein and shall not create or extend in any manner whatsoever, any liability of ST.

ST and the ST logo are trademarks or registered trademarks of ST in various countries.

Information in this document supersedes and replaces all information previously supplied.

The ST logo is a registered trademark of STMicroelectronics. All other names are the property of their respective owners.

© 2009 STMicroelectronics - All rights reserved

STMicroelectronics group of companies

Australia - Belgium - Brazil - Canada - China - Czech Republic - Finland - France - Germany - Hong Kong - India - Israel - Italy - Japan - Malaysia - Malta - Morocco - Philippines - Singapore - Spain - Sweden - Switzerland - United Kingdom - United States of America

www.st.com



Компания «ЭлектроПласт» предлагает заключение долгосрочных отношений при поставках импортных электронных компонентов на взаимовыгодных условиях!

Наши преимущества:

- Оперативные поставки широкого спектра электронных компонентов отечественного и импортного производства напрямую от производителей и с крупнейших мировых складов;
- Поставка более 17-ти миллионов наименований электронных компонентов;
- Поставка сложных, дефицитных, либо снятых с производства позиций;
- Оперативные сроки поставки под заказ (от 5 рабочих дней);
- Экспресс доставка в любую точку России;
- Техническая поддержка проекта, помощь в подборе аналогов, поставка прототипов;
- Система менеджмента качества сертифицирована по Международному стандарту ISO 9001;
- Лицензия ФСБ на осуществление работ с использованием сведений, составляющих государственную тайну;
- Поставка специализированных компонентов (Xilinx, Altera, Analog Devices, Intersil, Interpoint, Microsemi, Aeroflex, Peregrine, Syfer, Eurofarad, Texas Instrument, Miteq, Cobham, E2V, MA-COM, Hittite, Mini-Circuits, General Dynamics и др.);

Помимо этого, одним из направлений компании «ЭлектроПласт» является направление «Источники питания». Мы предлагаем Вам помощь Конструкторского отдела:

- Подбор оптимального решения, техническое обоснование при выборе компонента;
- Подбор аналогов;
- Консультации по применению компонента;
- Поставка образцов и прототипов;
- Техническая поддержка проекта;
- Защита от снятия компонента с производства.



Как с нами связаться

Телефон: 8 (812) 309 58 32 (многоканальный)

Факс: 8 (812) 320-02-42

Электронная почта: org@eplast1.ru

Адрес: 198099, г. Санкт-Петербург, ул. Калинина, дом 2, корпус 4, литера А.