



Ultra-Low Offset/Drift, Low-Noise, Precision SOT23 Amplifiers

MAX4238/MAX4239

General Description

The MAX4238/MAX4239 are low-noise, low-drift, ultra-high precision amplifiers that offer near-zero DC offset and drift through the use of patented autocorrelating zeroing techniques. This method constantly measures and compensates the input offset, eliminating drift over time and temperature and the effect of 1/f noise. Both devices feature rail-to-rail outputs, operate from a single 2.7V to 5.5V supply, and consume only 600 μ A. An active-low shutdown mode decreases supply current to 0.1 μ A.

The MAX4238 is unity-gain stable with a gain-bandwidth product of 1MHz, while the decompensated MAX4239 is stable with $A_v \geq 10V/V$ and a GBWP of 6.5MHz. The MAX4238/MAX4239 are available in 8-pin narrow SO, 6-pin TDFN and SOT23 packages.

Applications

Thermocouples
Strain Gauges
Electronic Scales
Medical Instrumentation
Instrumentation Amplifiers

Typical Application Circuit

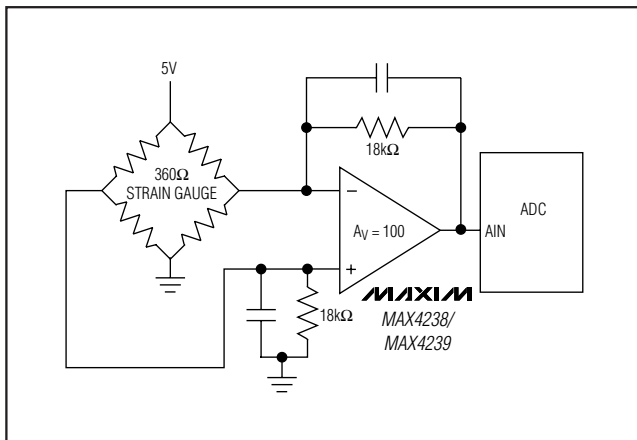

Features

- ◆ Ultra-Low, 0.1 μ V Offset Voltage
 - 2.0 μ V (max) at +25 $^{\circ}$ C
 - 2.5 μ V (max) at -40 $^{\circ}$ C to +85 $^{\circ}$ C
 - 3.5 μ V (max) at -40 $^{\circ}$ C to +125 $^{\circ}$ C
- ◆ Low 10nV/ $^{\circ}$ C Drift
- ◆ Specified over the -40 $^{\circ}$ C to +125 $^{\circ}$ C Automotive Temperature Range
- ◆ Low Noise: 1.5 μ Vp-p from DC to 10Hz
- ◆ 150dB A_{VOL} , 140dB PSRR, 140dB CMRR
- ◆ High Gain-Bandwidth Product
 - 1MHz (MAX4238)
 - 6.5MHz (MAX4239)
- ◆ 0.1 μ A Shutdown Mode
- ◆ Rail-to-Rail Output ($R_L = 1k\Omega$)
- ◆ Low 600 μ A Supply Current
- ◆ Ground-Sensing Input
- ◆ Single 2.7V to 5.5V Supply Voltage Range
- ◆ Available in a Space-Saving 6-Pin SOT23 and TDFN Packages

Ordering Information

PART	PIN-PACKAGE	TOP MARK
MAX4238AUT-T	6 SOT23	AAZZ
MAX4238AUT/V+T	6 SOT23	—
MAX4238ASA	8 SO	—
MAX4238ATT+T	6 TDFN-EP*	+ANG
MAX4239AUT-T	6 SOT23	ABAA
MAX4239AUT/V+T	6 SOT23	—
MAX4239ASA	8 SO	—
MAX4239ATT+T	6 TDFN-EP*	+ANH

Note: All devices are specified over the -40 $^{\circ}$ C to +125 $^{\circ}$ C operating temperature range.

+Denotes a lead(Pb)-free/RoHS-compliant package.

*EP = Exposed paddle.

/V denotes an automotive-qualified part.

Selector Guide

PART	MINIMUM STABLE GAIN	GAIN BANDWIDTH (MHz)
MAX4238	1V/V	1
MAX4239	10V/V	6.5

Pin Configurations appear at end of data sheet.



Ultra-Low Offset/Drift, Low-Noise, Precision SOT23 Amplifiers

ABSOLUTE MAXIMUM RATINGS

Power-Supply Voltage (V_{CC} to GND).....6V
 All Other Pins($V_{GND} - 0.3V$) to ($V_{CC} + 0.3V$)
 Output Short-Circuit Duration
 (OUT shorted to V_{CC} or GND)Continuous
 Continuous Power Dissipation ($T_A = +70^\circ C$)
 6-Pin Plastic SOT23
 (derate 9.1mW/ $^\circ C$ above $+70^\circ C$).....727mW
 8-Pin Plastic SO (derate 5.88mW/ $^\circ C$ above $+70^\circ C$)....471mW
 6-Pin TDFN-EP (derate 18.2mW above $+70^\circ C$).....1454mW

Operating Temperature Range $-40^\circ C$ to $+125^\circ C$
 Junction Temperature $+150^\circ C$
 Storage Temperature Range $-65^\circ C$ to $+150^\circ C$
 Lead Temperature (soldering, 10s) $+300^\circ C$
 Soldering Temperature (reflow)
 Lead(Pb)-Free Packages..... $+260^\circ C$
 Packages Containing Lead..... $+240^\circ C$

Stresses beyond those listed under "Absolute Maximum Ratings" may cause permanent damage to the device. These are stress ratings only, and functional operation of the device at these or any other conditions beyond those indicated in the operational sections of the specifications is not implied. Exposure to absolute maximum rating conditions for extended periods may affect device reliability.

ELECTRICAL CHARACTERISTICS

($2.7V \leq V_{CC} \leq 5.5V$, $V_{CM} = V_{GND} = 0V$, $V_{OUT} = V_{CC}/2$, $R_L = 10k\Omega$ connected to $V_{CC}/2$, $\overline{SHDN} = V_{CC}$, $T_A = +25^\circ C$, unless otherwise noted.)

PARAMETER	SYMBOL	CONDITIONS	MIN	TYP	MAX	UNITS
Input Offset Voltage	V_{OS}	(Note 1)		0.1	2	μV
Long-Term Offset Drift				50		nV/1000hr
Input Bias Current	I_B	(Note 2)		1		pA
Input Offset Current	I_{OS}	(Note 2)		2		pA
Peak-to-Peak Input Noise Voltage	e_{nP-P}	$R_S = 100\Omega$, 0.01Hz to 10Hz		1.5		μV_{P-P}
Input Voltage-Noise Density	e_n	$f = 1kHz$		30		NV/ \sqrt{Hz}
Common-Mode Input Voltage Range	V_{CM}	Inferred from CMRR test	$V_{GND} - 0.1$		$V_{CC} - 1.3$	V
Common-Mode Rejection Ratio	CMRR	$-0.1V \leq V_{CM} \leq V_{CC} - 1.3V$ (Note 1)	120	140		dB
Power-Supply Rejection Ratio	PSRR	$2.7V \leq V_{CC} \leq 5.5V$ (Note 1)	120	140		dB
Large-Signal Voltage Gain	A_{VOL}	$0.05V \leq V_{OUT} \leq V_{CC} - 0.05V$ (Note 1)	$R_L = 10k\Omega$	125	150	dB
		$0.1V \leq V_{OUT} \leq V_{CC} - 0.1V$ (Note 1)	$R_L = 1k\Omega$	125	145	
Output Voltage Swing	V_{OH}/V_{OL}	$R_L = 10k\Omega$	$V_{CC} - V_{OH}$	4	10	mV
			V_{OL}	4	10	
		$R_L = 1k\Omega$	$V_{CC} - V_{OH}$	35	50	
			V_{OL}	35	50	
Output Short-Circuit Current		To either supply		40		mA
Output Leakage Current		$0 \leq V_{OUT} \leq V_{CC}$, $\overline{SHDN} = GND$ (Note 2)		0.01	1	μA
Slew Rate		$V_{CC} = 5V$, $C_L = 100pF$, $V_{OUT} = 2V$ step	MAX4238	0.35		V/ μs
			MAX4239	1.6		
Gain-Bandwidth Product	GBWP	$R_L = 10k\Omega$, $C_L = 100pF$, measured at $f = 100kHz$	MAX4238	1		MHz
			MAX4239	6.5		
Minimum Stable Closed-Loop Gain		$R_L = 10k\Omega$, $C_L = 100pF$, phase margin = 60°	MAX4238	1		V/V
			MAX4239	10		

Ultra-Low Offset/Drift, Low-Noise, Precision SOT23 Amplifiers

MAX4238/MAX4239

ELECTRICAL CHARACTERISTICS (continued)

($2.7V \leq V_{CC} \leq 5.5V$, $V_{CM} = V_{GND} = 0V$, $V_{OUT} = V_{CC}/2$, $R_L = 10k\Omega$ connected to $V_{CC}/2$, $\overline{SHDN} = V_{CC}$, $T_A = +25^\circ C$, unless otherwise noted.)

PARAMETER	SYMBOL	CONDITIONS	MIN	TYP	MAX	UNITS
Maximum Closed-Loop Gain		$R_L = 10k\Omega$, $C_L = 100pF$, phase margin = 60°	MAX4238	1000		V/V
			MAX4239	6700		
Settling Time		-1V step	0.1% (10 bit)	0.5		ms
			0.025% (12 bit)	1.0		
			0.006% (14 bit)	1.7		
			0.0015% (16 bit)	2.3		
Overload Recovery Time		$A_V = 10$ (Note 4)	0.1% (10 bit)	3.3		ms
			0.025% (12 bit)	4.1		
			0.006% (14 bit)	4.9		
			0.0015% (16 bit)	5.7		
Startup Time		$A_V = 10$	0.1% (10 bit)	1.8		ms
			0.025% (12 bit)	2.6		
			0.006% (14 bit)	3.4		
			0.0015% (16 bit)	4.3		
Supply Voltage Range	V_{CC}	Inferred by PSRR test	2.7		5.5	V
Supply Current	I_{CC}	$\overline{SHDN} = V_{CC}$, no load, $V_{CC} = 5.5V$		600	850	μA
		$\overline{SHDN} = GND$, $V_{CC} = 5.5V$		0.1	1	
Shutdown Logic-High	V_{IH}		2.2			V
Shutdown Logic-Low	V_{IL}				0.8	V
Shutdown Input Current		$0V \leq \overline{SHDN} \leq V_{CC}$		0.1	1	μA

Ultra-Low Offset/Drift, Low-Noise, Precision SOT23 Amplifiers

ELECTRICAL CHARACTERISTICS

($2.7V \leq V_{CC} \leq 5.5V$, $V_{CM} = GND = 0V$, $V_{OUT} = V_{CC}/2$, $R_L = 10k\Omega$ connected to $V_{CC}/2$, $\overline{SHDN} = V_{CC}$, $T_A = -40^\circ C$ to $+125^\circ C$, unless otherwise noted.) (Note 5)

PARAMETER	SYMBOL	CONDITIONS		MIN	TYP	MAX	UNITS
Input Offset Voltage	V_{OS}	(Note 1)	$T_A = -40^\circ C$ to $+85^\circ C$			2.5	μV
			$T_A = -40^\circ C$ to $+125^\circ C$			3.5	
Input Offset Drift	TCV_{OS}	(Note 1)			10		$nV/^\circ C$
Common-Mode Input Voltage Range	V_{CM}	Inferred from CMRR test		$V_{GND} - 0.05$		$V_{CC} - 1.4$	V
Common-Mode Rejection Ratio	CMRR	$V_{GND} - 0.05V \leq V_{CM} \leq V_{CC} - 1.4V$ (Note 1)	$T_A = -40^\circ C$ to $+85^\circ C$	115			dB
			$T_A = -40^\circ C$ to $+125^\circ C$	90			
Power-Supply Rejection Ratio	PSRR	$2.7V \leq V_{CC} \leq 5.5V$ (Note 1)		120			dB
Large-Signal Voltage Gain	A_{VOL}	$R_L = 10k\Omega$, $0.1V \leq V_{OUT} \leq V_{CC} - 0.1V$ (Note 1)	$T_A = -40^\circ C$ to $+85^\circ C$	125			dB
			$T_A = -40^\circ C$ to $+125^\circ C$	95			
		$R_L = 1k\Omega$ (Note 1)	$0.1V \leq V_{OUT} \leq V_{CC} - 0.1V$, $T_A = -40^\circ C$ to $+85^\circ C$	120			dB
			$0.2V \leq V_{OUT} \leq V_{CC} - 0.2V$, $T_A = -40^\circ C$ to $+125^\circ C$	80			
Output Voltage Swing	V_{OH}/V_{OL}	$R_L = 10k\Omega$	$V_{CC} - V_{OH}$			20	mV
			V_{OL}			20	
		$R_L = 1k\Omega$	$V_{CC} - V_{OH}$			100	
			V_{OL}			100	
Output Leakage Current		$0V \leq V_{OUT} \leq V_{CC}$, $\overline{SHDN} = GND$ (Note 3)				2	μA
Supply Voltage Range	V_{CC}	Inferred by PSRR test		2.7		5.5	V
Supply Current	I_{CC}	$\overline{SHDN} = V_{CC}$, no load, $V_{CC} = 5.5V$				900	μA
		$\overline{SHDN} = GND$, $V_{CC} = 5.5V$				2	
Shutdown Logic High	V_{IH}			2.2			V
Shutdown Logic Low	V_{IL}					0.7	V
Shutdown Input Current		$0V \leq \overline{SHDN} \leq V_{CC}$				2	μA

Note 1: Guaranteed by design. Thermocouple and leakage effects preclude measurement of this parameter during production testing. Devices are screened during production testing to eliminate defective units.

Note 2: IN+ and IN- are gates to CMOS transistors with typical input bias current of 1pA. CMOS leakage is so small that it is impractical to test and guarantee in production. Devices are screened during production testing to eliminate defective units.

Note 3: Leakage does not include leakage through feedback resistors.

Note 4: Overload recovery time is the time required for the device to recover from saturation when the output has been driven to either rail.

Note 5: Specifications are 100% tested at $T_A = +25^\circ C$, unless otherwise noted. Limits over temperature are guaranteed by design.

Ultra-Low Offset/Drift, Low-Noise, Precision SOT23 Amplifiers

Typical Operating Characteristics

($V_{CC} = 5V$, $V_{CM} = 0V$, $R_L = 10k\Omega$ connected to $V_{CC}/2$, $\overline{SHDN} = V_{CC}$, $T_A = +25^\circ C$, unless otherwise noted.)

MAX4238/MAX4239

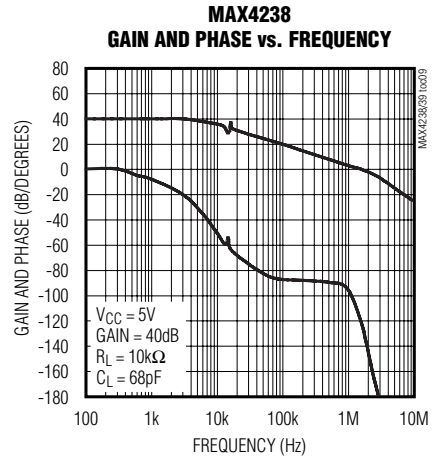
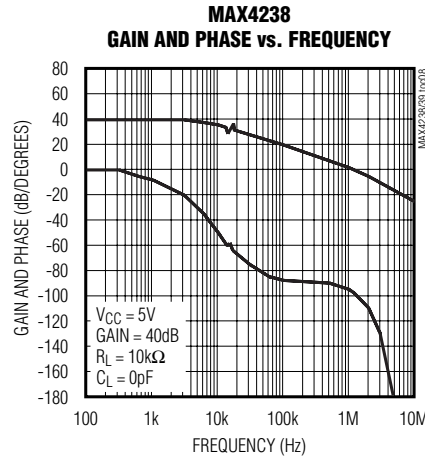
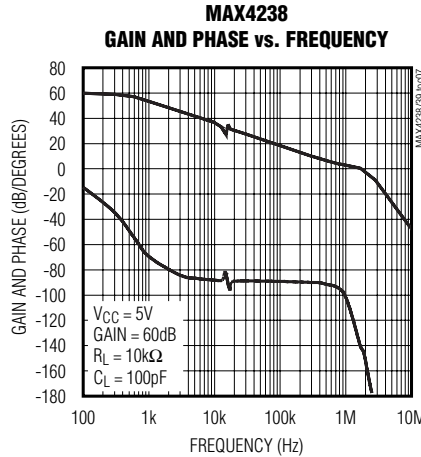
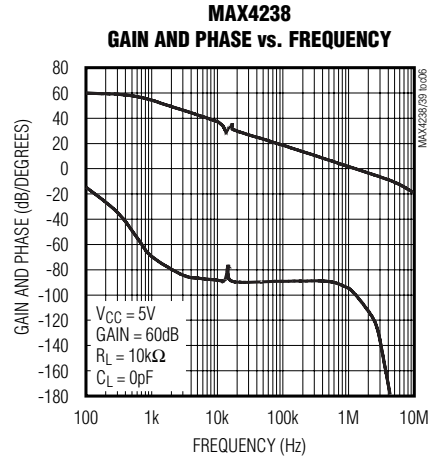
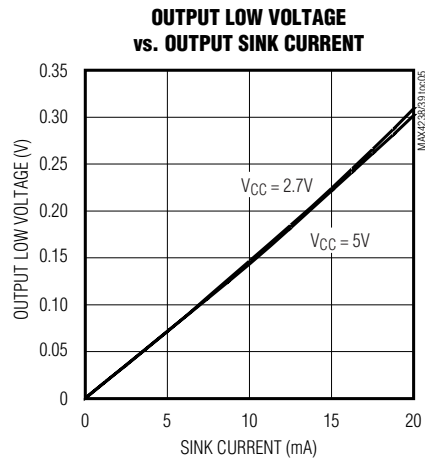
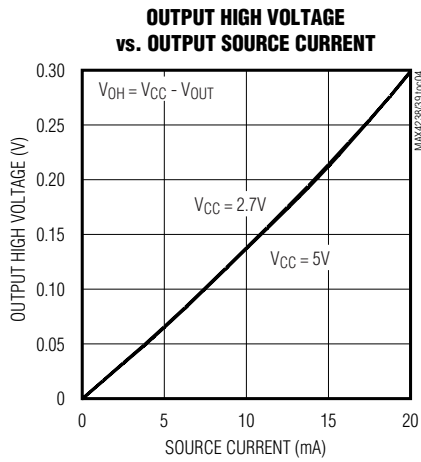
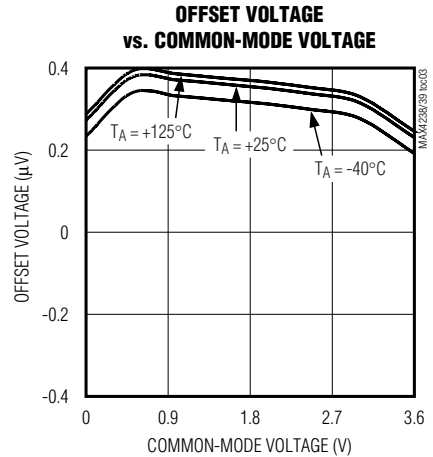
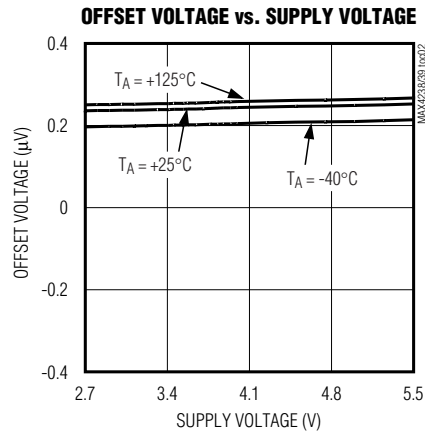
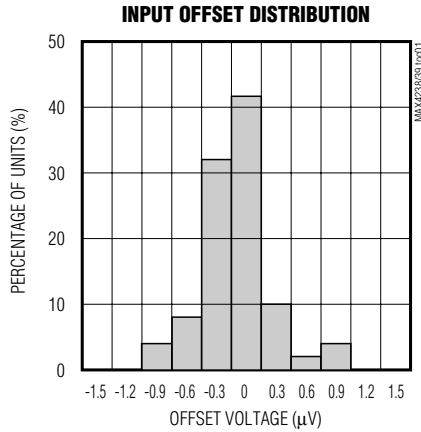

Ultra-Low Offset/Drift, Low-Noise, Precision SOT23 Amplifiers

Typical Operating Characteristics (continued)

($V_{CC} = 5V$, $V_{CM} = 0V$, $R_L = 10k\Omega$ connected to $V_{CC}/2$, $\overline{SHDN} = V_{CC}$, $T_A = +25^\circ C$, unless otherwise noted.)

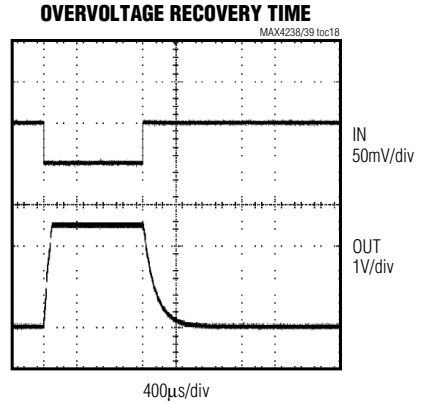
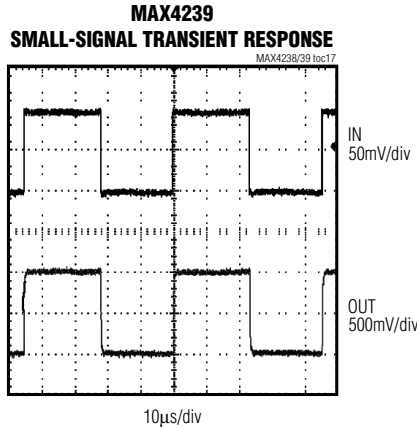
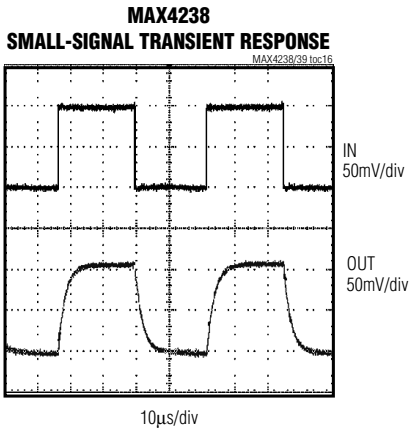
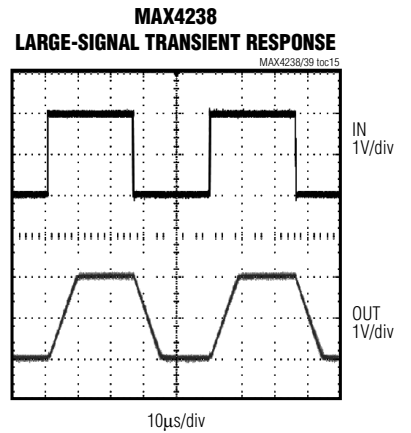
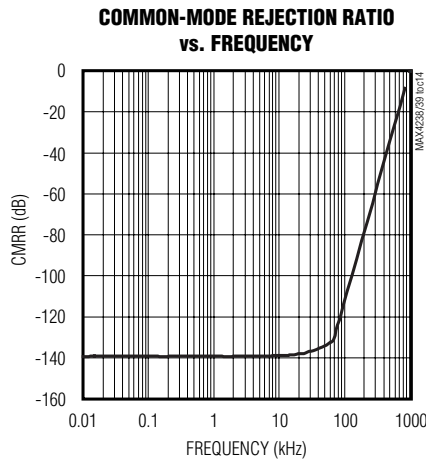
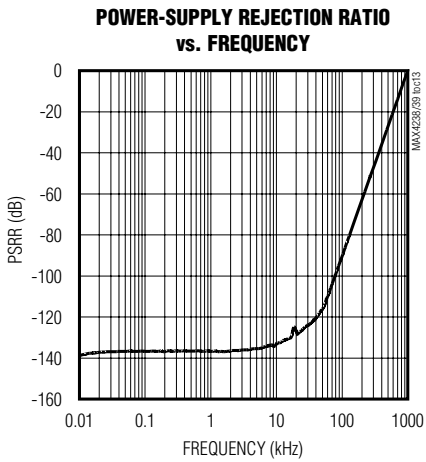
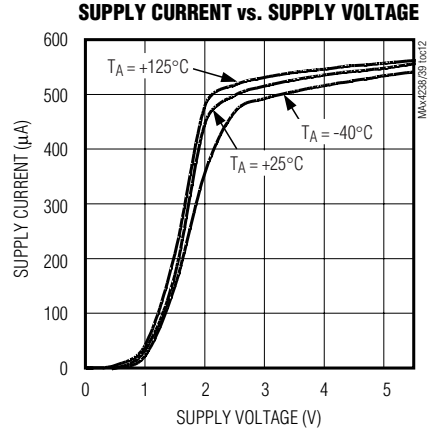
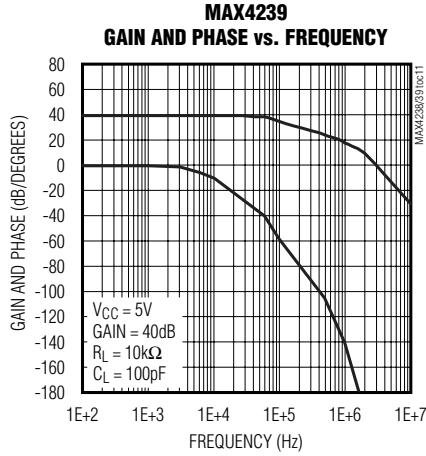
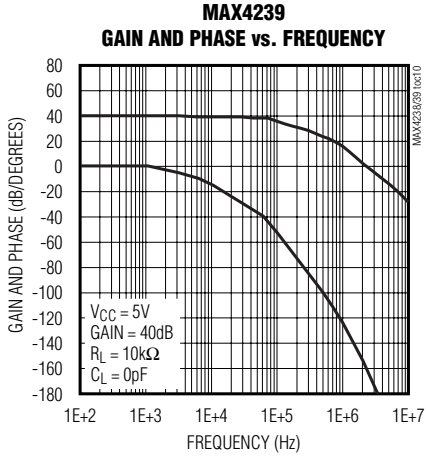

Ultra-Low Offset/Drift, Low-Noise, Precision SOT23 Amplifiers

MAX4238/MAX4239

Typical Operating Characteristics (continued)

($V_{CC} = 5V$, $V_{CM} = 0V$, $R_L = 10k\Omega$ connected to $V_{CC}/2$, $\overline{SHDN} = V_{CC}$, $T_A = +25^\circ C$, unless otherwise noted.)

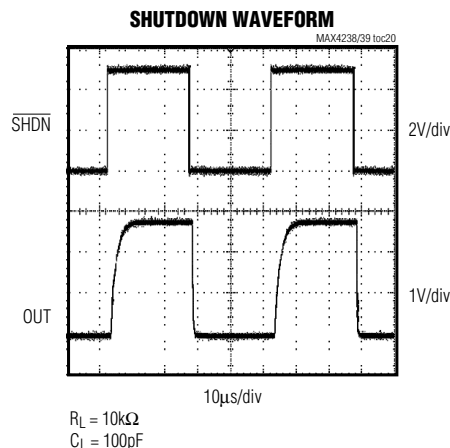
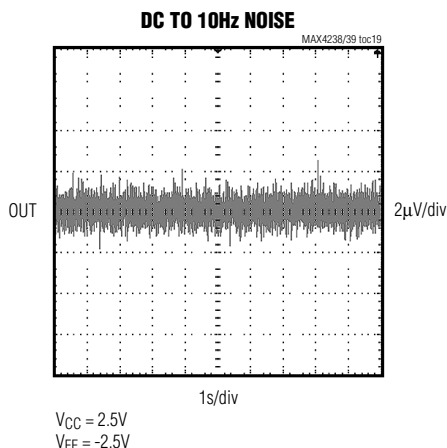

Pin Description

PIN			NAME	FUNCTION
TDFN	SOT23	SO		
1	1	6	OUT	Amplifier Output
2	2	4	GND	Ground
3	3	3	IN+	Noninverting Input
4	4	2	IN-	Inverting Input
5	5	1	\overline{SHDN}	Shutdown Input. Active-low shutdown, connect to V_{CC} for normal operation.
6	6	7	V_{CC}	Positive Power Supply
—	—	5, 8	N.C.	No Connection. Not internally connected.
—	—	—	EP	Exposed Pad (TDFN only). Connect EP to GND.

Detailed Description

The MAX4238/MAX4239 are high-precision amplifiers that have less than $2.5\mu V$ of input-referred offset and low $1/f$ noise. These characteristics are achieved through a patented autozeroing technique that samples and cancels the input offset and noise of the amplifier. The pseudorandom clock frequency varies from 10kHz to 15kHz, reducing intermodulation distortion present in chopper-stabilized amplifiers.

Offset Error Sources

To achieve very low offset, several sources of error common to autozero-type amplifiers need to be considered. The first contributor is the settling of the sampling capacitor. This type of error is independent of input-source impedance, or the size of the external gain-setting resistors. Maxim uses a patented design technique to avoid large changes in the voltage on the sampling capacitor to reduce settling time errors.

The second error contributor, which is present in both autozero and chopper-type amplifiers, is the charge injection from the switches. The charge injection appears as current spikes at the input, and combined with the impedance seen at the amplifier's input, contributes to input offset voltage. Minimize this feedthrough by reducing the size of the gain-setting resistors and the input-source impedance. A capacitor in parallel with the feedback resistor reduces the amount of clock feedthrough to the output by limiting the closed-loop bandwidth of the device.

The design of the MAX4238/MAX4239 minimizes the effects of settling and charge injection to allow specification of an input offset voltage of $0.1\mu V$ (typ) and less than $2.5\mu V$ over temperature ($-40^\circ C$ to $+85^\circ C$).

1/f Noise

$1/f$ noise, inherent in all semiconductor devices, is inversely proportional to frequency. $1/f$ noise increases 3dB/octave and dominates amplifier noise at lower frequencies. This noise appears as a constantly changing voltage in series with any signal being measured. The MAX4238/MAX4239 treat $1/f$ noise as a slow varying offset error, inherently canceling the $1/f$ noise.

Ultra-Low Offset/Drift, Low-Noise, Precision SOT23 Amplifiers

Output Overload Recovery

Autozeroing amplifiers typically require a substantial amount of time to recover from an output overload. This is due to the time it takes for the null amplifier to correct the main amplifier to a valid output. The MAX4238/MAX4239 require only 3.3ms to recover from an output overload (see *Electrical Characteristics* and *Typical Operating Characteristics*).

Shutdown

The MAX4238/MAX4239 feature a low-power (0.1µA) shutdown mode. When $\overline{\text{SHDN}}$ is pulled low, the clock stops and the device output enters a high-impedance state. Connect $\overline{\text{SHDN}}$ to V_{CC} for normal operation.

Applications Information

Minimum and Maximum Gain Configurations

The MAX4238 is a unity-gain stable amplifier with a gain-bandwidth product (GBWP) of 1MHz. The MAX4239 is decompensated for a GBWP of 6.5MHz and is stable with a gain of 10V/V. Unlike conventional operational amplifiers, the MAX4238/MAX4239 have a maximum gain specification. To maintain stability, set the gain of the MAX4238 between $A_V = 1000\text{V/V}$ to 1V/V , and set the gain of the MAX4239 between $A_V = 6700\text{V/V}$ and 10V/V .

ADC Buffer Amplifier

The low offset, fast settling time, and $1/f$ noise cancellation of the MAX4238/MAX4239 make these devices ideal for ADC buffers. The MAX4238/MAX4239 are well suited for low-speed, high-accuracy applications such as strain gauges (see *Typical Application Circuit*).

Error Budget Example

When using the MAX4238/MAX4239 as an ADC buffer, the temperature drift should be taken into account when determining the maximum input signal. With a typical offset drift of $10\text{nV}/^\circ\text{C}$, the drift over a 10°C range is 100nV . Setting this equal to $1/2\text{LSB}$ in a 16-bit system yields a full-scale range of 13mV . With a single 2.7V supply, an acceptable closed-loop gain is $A_V = 200$. This provides sufficient gain while maintaining headroom.

Pin Configurations

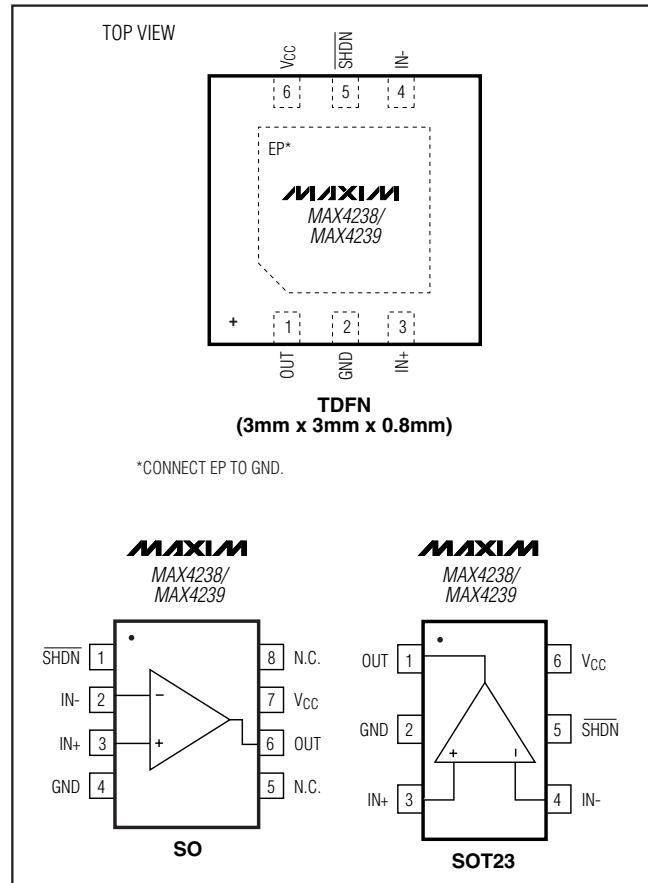

Chip Information

PROCESS: BiCMOS

Package Information

For the latest package outline information and land patterns (footprints), go to www.maxim-ic.com/packages. Note that a "+", "#", or "-" in the package code indicates RoHS status only. Package drawings may show a different suffix character, but the drawing pertains to the package regardless of RoHS status.

PACKAGE TYPE	PACKAGE CODE	OUTLINE NO.	LAND PATTERN NO.
6 SOT23	U6F-6	21-0058	90-0175
8 SO	S8-4	21-0041	90-0096
6 TDFN	T633+2	21-0137	90-0058

Ultra-Low Offset/Drift, Low-Noise, Precision SOT23 Amplifiers

Revision History

REVISION NUMBER	REVISION DATE	DESCRIPTION	PAGES CHANGED
2	5/06	—	—
3	8/11	Added MAX4238 and MAX4239 automotive-qualified parts	1

MAX4238/MAX4239

Maxim cannot assume responsibility for use of any circuitry other than circuitry entirely embodied in a Maxim product. No circuit patent licenses are implied. Maxim reserves the right to change the circuitry and specifications without notice at any time. The parametric values (min and max limits) shown in the Electrical Characteristics table are guaranteed. Other parametric values quoted in this data sheet are provided for guidance.

9 _____ **Maxim Integrated Products, 120 San Gabriel Drive, Sunnyvale, CA 94086 408-737-7600**



Компания «ЭлектроПласт» предлагает заключение долгосрочных отношений при поставках импортных электронных компонентов на взаимовыгодных условиях!

Наши преимущества:

- Оперативные поставки широкого спектра электронных компонентов отечественного и импортного производства напрямую от производителей и с крупнейших мировых складов;
- Поставка более 17-ти миллионов наименований электронных компонентов;
- Поставка сложных, дефицитных, либо снятых с производства позиций;
- Оперативные сроки поставки под заказ (от 5 рабочих дней);
- Экспресс доставка в любую точку России;
- Техническая поддержка проекта, помощь в подборе аналогов, поставка прототипов;
- Система менеджмента качества сертифицирована по Международному стандарту ISO 9001;
- Лицензия ФСБ на осуществление работ с использованием сведений, составляющих государственную тайну;
- Поставка специализированных компонентов (Xilinx, Altera, Analog Devices, Intersil, Interpoint, Microsemi, Aeroflex, Peregrine, Syfer, Eurofarad, Texas Instrument, Miteq, Cobham, E2V, MA-COM, Hittite, Mini-Circuits, General Dynamics и др.);

Помимо этого, одним из направлений компании «ЭлектроПласт» является направление «Источники питания». Мы предлагаем Вам помощь Конструкторского отдела:

- Подбор оптимального решения, техническое обоснование при выборе компонента;
- Подбор аналогов;
- Консультации по применению компонента;
- Поставка образцов и прототипов;
- Техническая поддержка проекта;
- Защита от снятия компонента с производства.



Как с нами связаться

Телефон: 8 (812) 309 58 32 (многоканальный)

Факс: 8 (812) 320-02-42

Электронная почта: org@eplast1.ru

Адрес: 198099, г. Санкт-Петербург, ул. Калинина, дом 2, корпус 4, литера А.