

### MG17300D-BN4MM



#### Agency Approvals

AGENCY	AGENCY FILE NUMBER
	E71639

#### Features

- IGBT<sup>3</sup> CHIP(1700V Trench+Field Stop technology)
- Low turn-off losses, short tail current
- $V_{CE(sat)}$  with positive temperature coefficient
- DIODE CHIP(1700V EMCON 3 technology)
- Free wheeling diodes with fast and soft reverse recovery

#### Applications

- High frequency switching application
- Medical applications
- Motion/servo control
- UPS systems

#### Module Characteristics ( $T_c = 25^\circ\text{C}$ , unless otherwise specified)

Symbol	Parameters	Test Conditions	Min	Typ	Max	Unit
$T_{J(max)}$	Max. Junction Temperature				150	$^\circ\text{C}$
$T_{J(op)}$	Operating Temperature		-40		125	$^\circ\text{C}$
$T_{stg}$	Storage Temperature		-40		125	$^\circ\text{C}$
$V_{isol}$	Insulation Test Voltage	AC, t=1min		3000		V
CTI	Comparative Tracking Index		350			
Torque	Module-to-Sink	Recommended (M6)	3		5	N·m
Torque	Module Electrodes	Recommended (M6)	2.5		5	N·m
Weight				320		g

#### Absolute Maximum Ratings ( $T_c = 25^\circ\text{C}$ , unless otherwise specified)

Symbol	Parameters	Test Conditions	Values	Unit
<b>IGBT</b>				
$V_{CES}$	Collector - Emitter Voltage	$T_J=25^\circ\text{C}$	1700	V
$V_{GES}$	Gate - Emitter Voltage		$\pm 20$	V
$I_C$	DC Collector Current	$T_c=25^\circ\text{C}$	400	A
		$T_c=80^\circ\text{C}$	300	A
$I_{CM}$	Repetitive Peak Collector Current	$t_p=1\text{ms}$	600	A
$P_{tot}$	Power Dissipation Per IGBT		1450	W
<b>Diode</b>				
$V_{RRM}$	Repetitive Reverse Voltage	$T_J=25^\circ\text{C}$	1700	V
$I_{F(AV)}$	Average Forward Current	$T_c=25^\circ\text{C}$	400	A
		$T_c=80^\circ\text{C}$	300	A
$I_{FRM}$	Repetitive Peak Forward Current	$t_p=1\text{ms}$	600	A
$I^2t$		$T_J = 125^\circ\text{C}, t=10\text{ms}, V_R=0\text{V}$	14500	$\text{A}^2\text{S}$

Life Support Note:

#### Not Intended for Use in Life Support or Life Saving Applications

The products shown herein are not designed for use in life sustaining or life saving applications unless otherwise expressly indicated.

**Electrical and Thermal Specifications ( $T_c = 25^\circ\text{C}$ , unless otherwise specified)**

Symbol	Parameters	Test Conditions	Min	Typ	Max	Unit
<b>IGBT</b>						
$V_{GE(th)}$	Gate - Emitter Threshold Voltage	$V_{CE}=V_{GE}, I_C=12.0\text{mA}$	5.2	5.8	6.4	V
$V_{CE(sat)}$	Collector - Emitter Saturation Voltage	$I_C=300\text{A}, V_{GE}=15\text{V}, T_J=25^\circ\text{C}$		2.0	2.45	V
		$I_C=300\text{A}, V_{GE}=15\text{V}, T_J=125^\circ\text{C}$		2.4		V
$I_{CES}$	Collector Leakage Current	$V_{CE}=1700\text{V}, V_{GE}=0\text{V}, T_J=25^\circ\text{C}$			1	mA
		$V_{CE}=1700\text{V}, V_{GE}=0\text{V}, T_J=125^\circ\text{C}$			10	mA
$I_{GES}$	Gate Leakage Current	$V_{CE}=0\text{V}, V_{GE}=\pm 20\text{V}, T_J=125^\circ\text{C}$	-400		400	nA
$R_{Gint}$	Intergrated Gate Resistor			2.5		$\Omega$
$Q_{ge}$	Gate Charge	$V_{CE}=900\text{V}, I_C=300\text{A}, V_{GE}=\pm 15\text{V}$		3.5		$\mu\text{C}$
$C_{ies}$	Input Capacitance	$V_{CE}=25\text{V}, V_{GE}=0\text{V}, f=1\text{MHz}$		27		nF
$C_{res}$	Reverse Transfer Capacitance			0.9		nF
$t_{d(on)}$	Turn - on Delay Time	$V_{CC}=900\text{V}$ $I_C=300\text{A}$ $R_G=4.7\Omega$ $V_{GE}=\pm 15\text{V}$ Inductive Load	$T_J=25^\circ\text{C}$		280	ns
			$T_J=125^\circ\text{C}$		380	ns
$t_r$	Rise Time		$T_J=25^\circ\text{C}$		80	ns
			$T_J=125^\circ\text{C}$		100	ns
$t_{d(off)}$	Turn - off Delay Time		$T_J=25^\circ\text{C}$		800	ns
			$T_J=125^\circ\text{C}$		1000	ns
$t_f$	Fall Time		$T_J=25^\circ\text{C}$		120	ns
			$T_J=125^\circ\text{C}$		200	ns
$E_{on}$	Turn - on Energy		$T_J=25^\circ\text{C}$		71	mJ
			$T_J=125^\circ\text{C}$		105	mJ
$E_{off}$	Turn - off Energy	$T_J=25^\circ\text{C}$		64	mJ	
		$T_J=125^\circ\text{C}$		94	mJ	
$I_{SC}$	Short Circuit Current	$t_{psc}\leq 10\mu\text{S}, V_{GE}=15\text{V}, T_J=125^\circ\text{C}, V_{CC}=1000\text{V}$		1200		A
$R_{thJC}$	Junction-to-Case Thermal Resistance (Per IGBT)				0.085	K/W
<b>Diode</b>						
$V_F$	Forward Voltage	$I_F=300\text{A}, V_{GE}=0\text{V}, T_J=25^\circ\text{C}$		1.8	2.2	V
		$I_F=300\text{A}, V_{GE}=0\text{V}, T_J=125^\circ\text{C}$		1.9		V
$I_{RRM}$	Max. Reverse Recovery Current	$I_F=300\text{A}, V_R=900\text{V}$		380		A
$Q_{rr}$	Reverse Recovery Charge	$di_r/dt=-3600\text{A}/\mu\text{s}$		130		$\mu\text{C}$
$E_{rec}$	Reverse Recovery Energy	$T_J=125^\circ\text{C}$		75		mJ
$R_{thJCD}$	Junction-to-Case Thermal Resistance (Per Diode)				0.13	K/W

**Figure 1: Typical Output Characteristics**

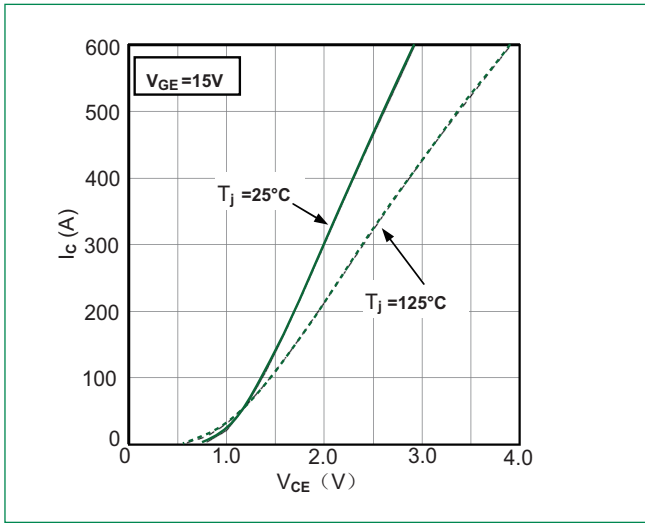

**Figure 2: Typical Output Characteristics**

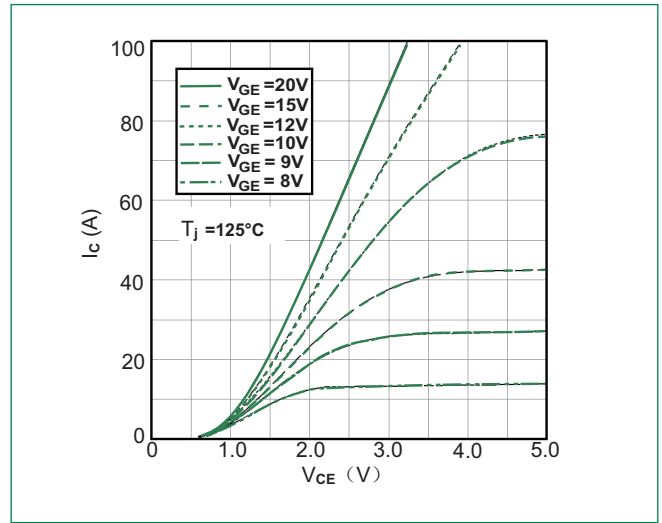

**Figure 3: Typical Transfer characteristics**

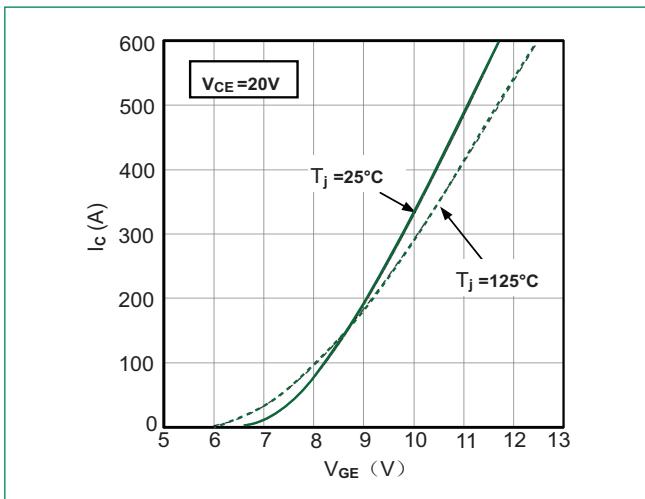

**Figure 4: Switching Energy vs. Gate Resistor**

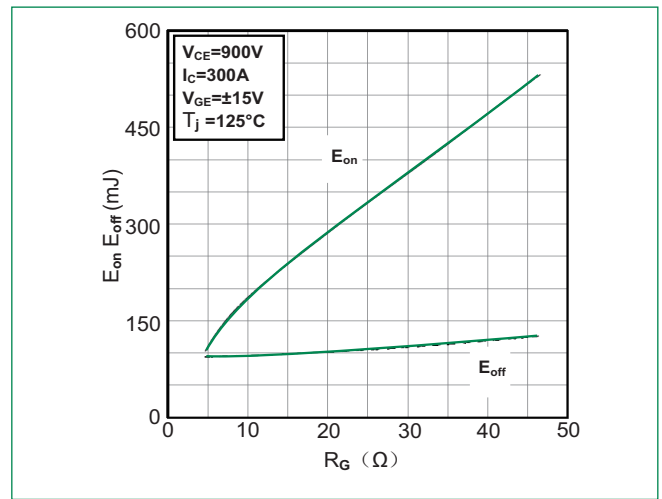

**Figure 5: Switching Energy vs. Collector Current**

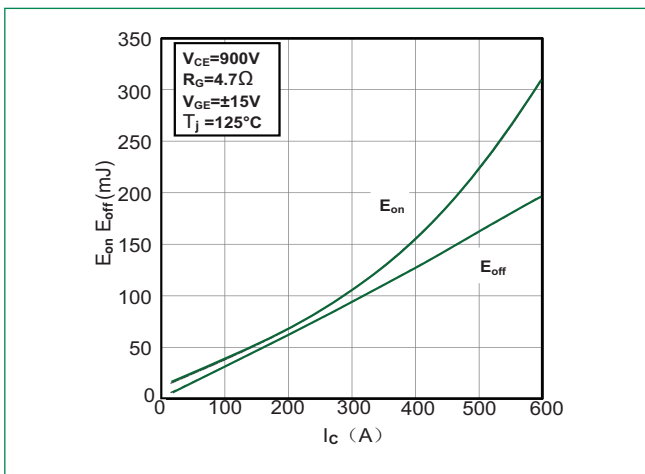

**Figure 6: Reverse Biased Safe Operating Area**

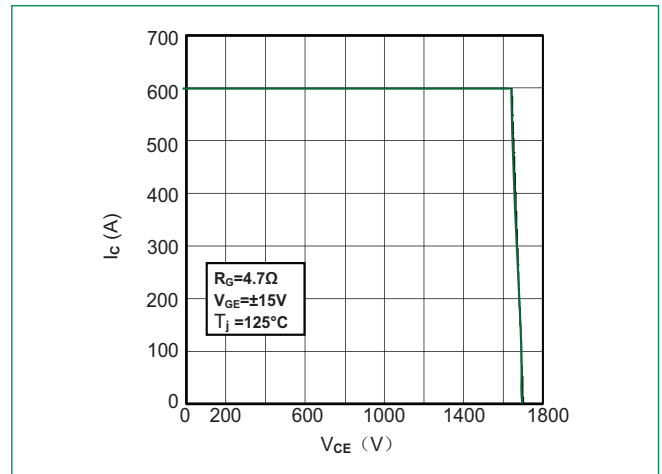

**Figure 7: Diode Forward Characteristics**

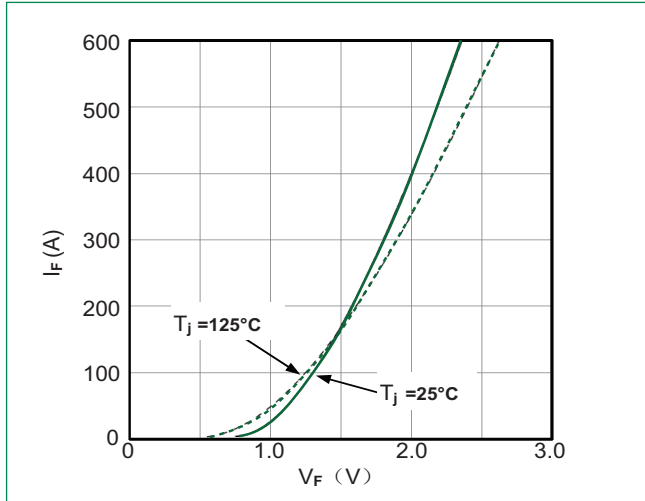

**Figure 8: Switching Energy vs. Gate Resistor**

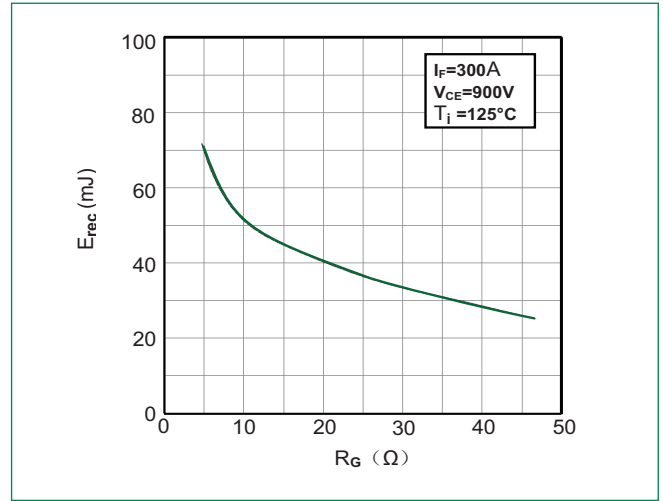

**Figure 9: Switching Energy vs. Forward Current**

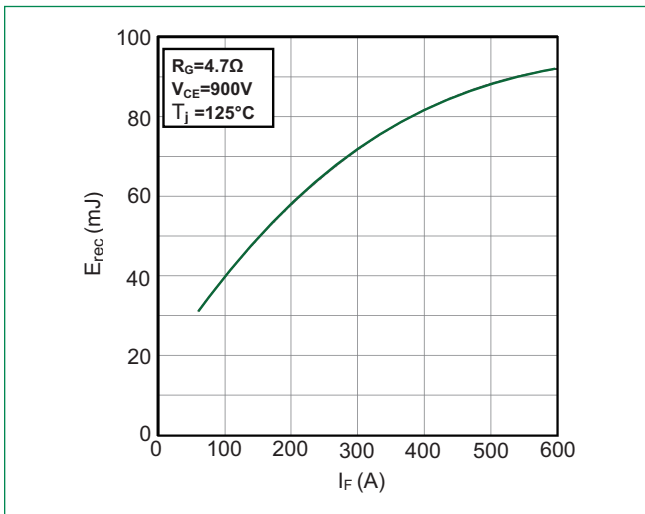

**Figure 10: Transient Thermal Impedance of Diode and IGBT**

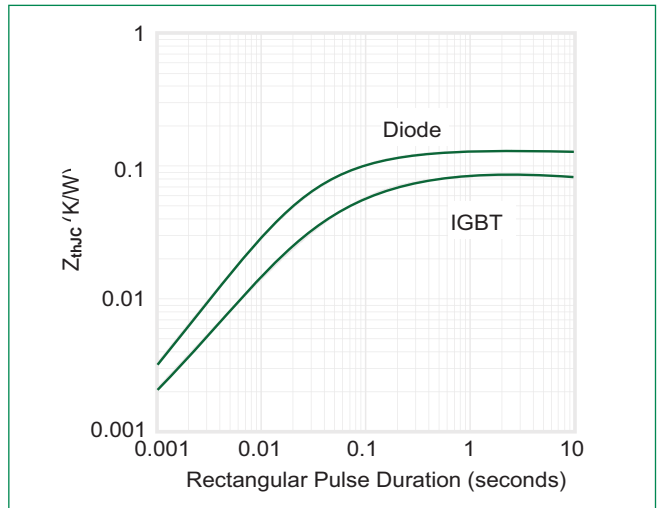

### Dimensions-Package D

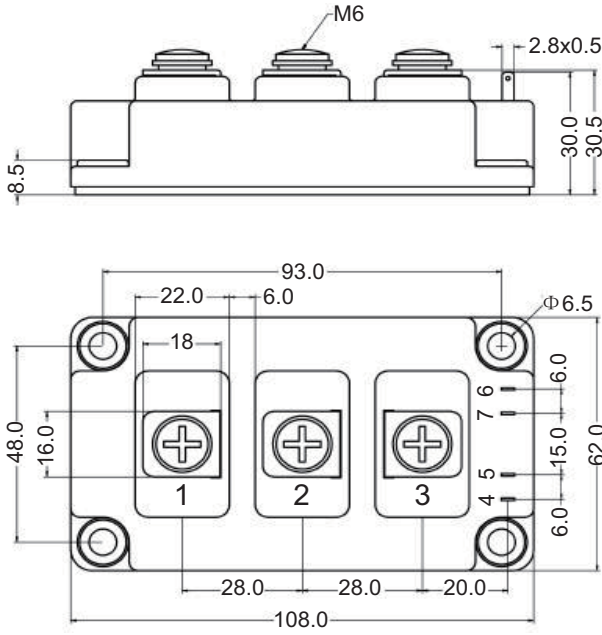

Dimensions in mm

### Circuit Diagram

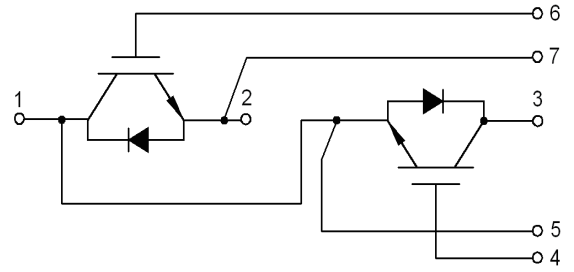

### Packing Options

Part Number	Marking	Weight	Packing Mode	M.O.Q
MG17300D-BN4MM	MG17300D-BN4MM	320g	Bulk Pack	30

### Part Numbering System

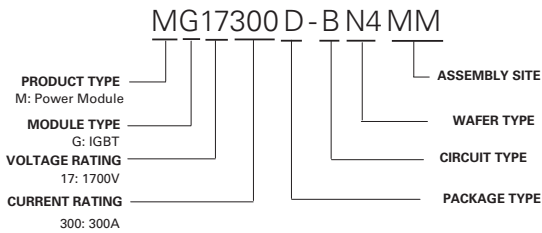

### Part Marking System

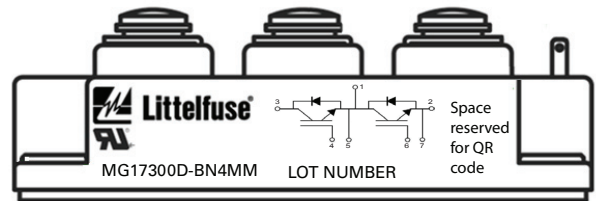



Компания «ЭлектроПласт» предлагает заключение долгосрочных отношений при поставках импортных электронных компонентов на взаимовыгодных условиях!

Наши преимущества:

- Оперативные поставки широкого спектра электронных компонентов отечественного и импортного производства напрямую от производителей и с крупнейших мировых складов;
- Поставка более 17-ти миллионов наименований электронных компонентов;
- Поставка сложных, дефицитных, либо снятых с производства позиций;
- Оперативные сроки поставки под заказ (от 5 рабочих дней);
- Экспресс доставка в любую точку России;
- Техническая поддержка проекта, помощь в подборе аналогов, поставка прототипов;
- Система менеджмента качества сертифицирована по Международному стандарту ISO 9001;
- Лицензия ФСБ на осуществление работ с использованием сведений, составляющих государственную тайну;
- Поставка специализированных компонентов (Xilinx, Altera, Analog Devices, Intersil, Interpoint, Microsemi, Aeroflex, Peregrine, Syfer, Eurofarad, Texas Instrument, Miteq, Cobham, E2V, MA-COM, Hittite, Mini-Circuits, General Dynamics и др.);

Помимо этого, одним из направлений компании «ЭлектроПласт» является направление «Источники питания». Мы предлагаем Вам помощь Конструкторского отдела:

- Подбор оптимального решения, техническое обоснование при выборе компонента;
- Подбор аналогов;
- Консультации по применению компонента;
- Поставка образцов и прототипов;
- Техническая поддержка проекта;
- Защита от снятия компонента с производства.



#### Как с нами связаться

**Телефон:** 8 (812) 309 58 32 (многоканальный)

**Факс:** 8 (812) 320-02-42

**Электронная почта:** [org@eplast1.ru](mailto:org@eplast1.ru)

**Адрес:** 198099, г. Санкт-Петербург, ул. Калинина, дом 2, корпус 4, литера А.