

### FEATURES

Interfaces to multiple serial and parallel precision converter evaluation boards

Supports high-speed LVDS interface

32MB SDRAM

4MB SRAM

USB 2.0 connection to PC

User reprogrammable Altera Cyclone FPGA

Provides 8 separate power supplies

Connects directly to Blackfin Ez-Kit

### APPLICATIONS

Evaluating Precision Converters

Creation of demonstration systems

Prototyping of end-user systems

### GENERAL DESCRIPTION

The CED1 board is part of a next generation platform from Analog Devices Inc., intended for use in evaluation, demonstration and development of systems using Analog Devices precision converters. It provides the necessary communications between the converter and the PC, programming or controlling the device, transmitting or receiving data over a USB link.

### PACKAGE CONTENTS

- CED Board
- USB A to Mini-B cable
- 7 Volt 15W Power Supply

### FUNCTIONAL BLOCK DIAGRAM

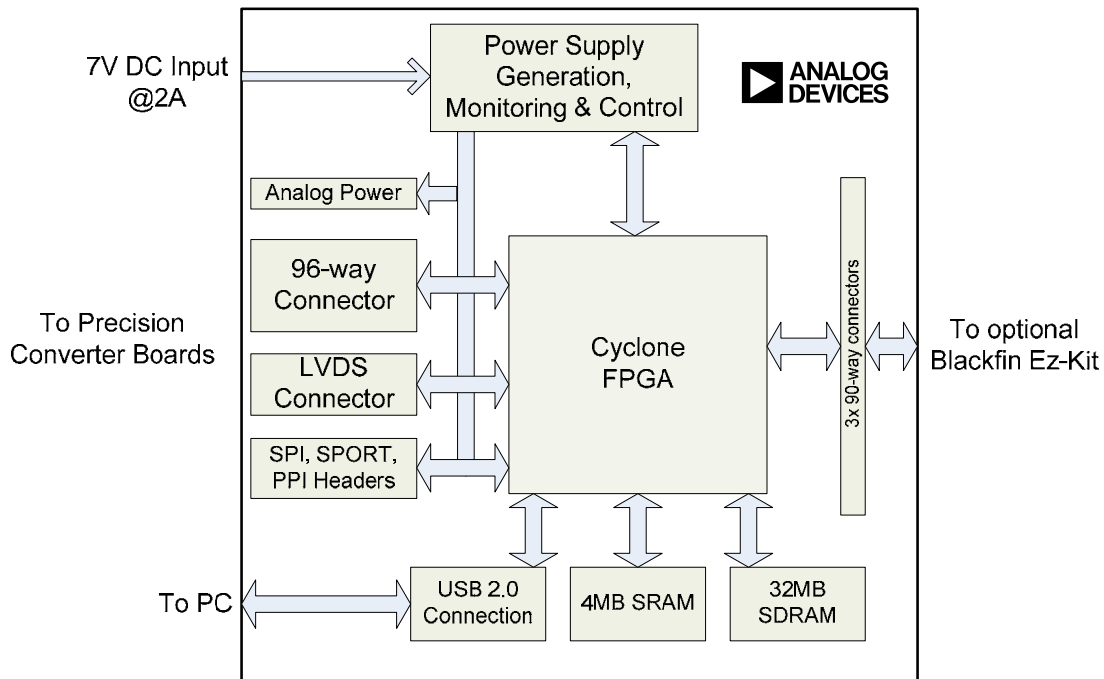

Figure 1.

#### Rev. PrA

Evaluation boards are only intended for device evaluation and not for production purposes. Evaluation boards are supplied "as is" and without warranties of any kind, express, implied, or statutory including, but not limited to, any implied warranty of merchantability or fitness for a particular purpose. No license is granted by implication or otherwise under any patents or other intellectual property by application or use of evaluation boards. Information furnished by Analog Devices is believed to be accurate and reliable. However, no responsibility is assumed by Analog Devices for its use, nor for any infringements of patents or other rights of third parties that may result from its use. Analog Devices reserves the right to change devices or specifications at any time without notice. Trademarks and registered trademarks are the property of their respective owners. Evaluation boards are not authorized to be used in life support devices or systems.

**TABLE OF CONTENTS**

Features .....	1	J6 – FPGA JTAG Connector .....	5
Applications .....	1	J8, 9, 10 – 3x 90-way Blackfin Ez-Kit connectors .....	5
General Description .....	1	J3 – 96-way DIN41612 Connector .....	5
Package Contents .....	1	J7 – Analog Power Connector .....	8
Functional Block Diagram .....	1	J12 – SPORT Interface .....	8
Revision History .....	2	J13 – SPI Interface .....	9
General Description .....	3	J14 – PPI Interface .....	9
Connectors .....	4	Connector Part Numbers .....	9
J5 – LVDS Connector .....	4	Power Supplies .....	10
J1 – Mini USB ‘B’ connector .....	5	Schematics .....	11
J2 – 2-pin screw terminal power connector .....	5	Ordering Guide .....	24
J4 – DC Power Connector .....	5	ESD Caution .....	24

**REVISION HISTORY****7/07—Revision 0: Initial Revision**

## GENERAL DESCRIPTION

The Converter Evaluation and Development board is intended to assist system designers evaluate and prototype systems utilizing precision converter components from Analog Devices. It provides a means to read and write data, control and program devices from a PC via a high-speed USB 2.0 connection.

Due to its design, the CED1 can handle interfacing to multiple devices simultaneously for users who may wish to prototype their system utilizing proven hardware components from Analog Devices.

The reconfigurable FPGA-based architecture of the board allows the FPGA to be reprogrammed at any time via the USB connection. This allows the user to develop and run their own code to accomplish their desired task.

The many interfacing options accommodate connection to a wide range of precision converter evaluation boards in different form factors. Three standard 0.1-inch pitch headers are available, supporting SPI, SPORT and parallel functionality. A 96-way connector provides links to multiple

interfaces and power supplies simultaneously. LVDS is supported through a dedicated connector designed for data pairs with individual grounds.

For developments that require a processor as well as an FPGA, the CED1 board provides the means to connect directly to a Blackfin EZ-Kit. Three 90-way connectors present on the board mate directly with the Blackfin Ez-Kit allowing the development of very powerful systems and demonstrations.

To help minimize the amount of external equipment needed to run a system successfully, the CED board provides eight separate power supplies made available for external connection. The details of these supplies and their current ratings are contained in the Power Supply section of this document.

The CED board requires a single 7V, 15W supply which ships with the board. The user may also connect a bench-top supply providing it can source a minimum current of 2A.

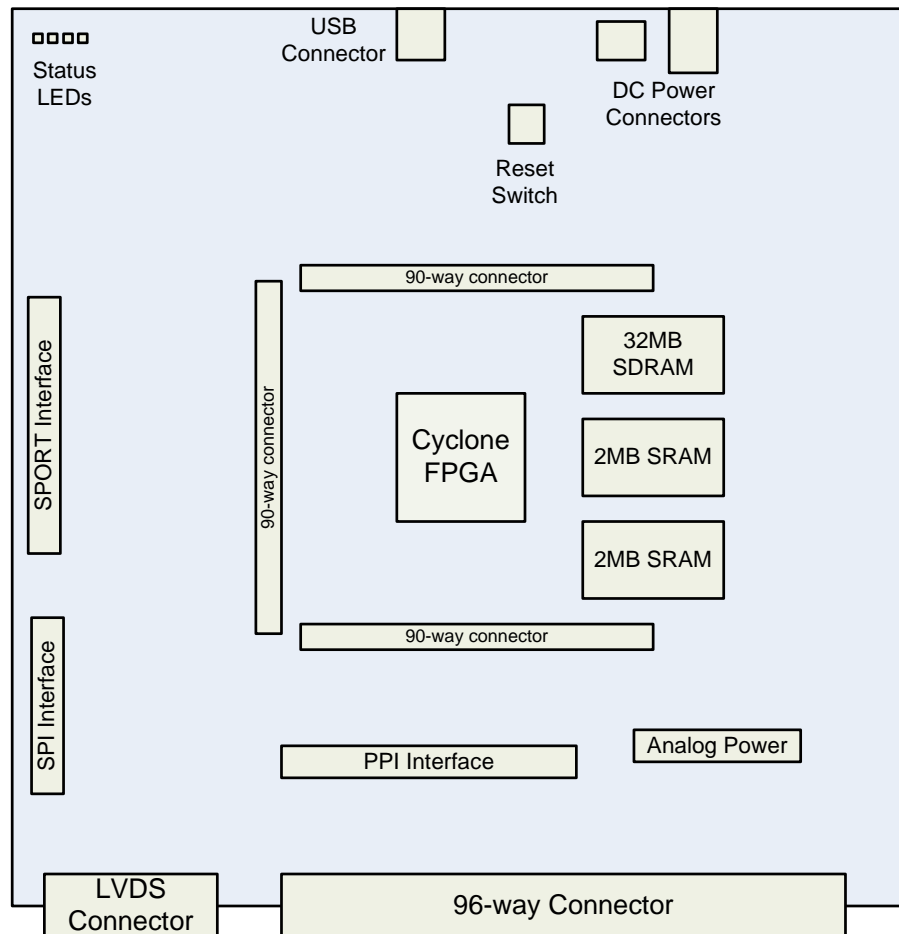

Figure 2. Major Component Locations

## CONNECTORS

Many connectors are provided on the CED board to facilitate design and attachment of a range of different form factor converter boards. Due to the number of connections available on the FPGA, certain signals on different connectors are shared and replicated across different connectors.

All signals have been named to assist the user in identifying the shared signals and to which group they belong. SPI signals begin with SPI\_xxx, SPORT signals begin with SPORT\_xxx and parallel/PPI signals begin with PAR\_xxx/PPI\_xxx. More details of these signals are given in the relevant connector sections.

### J5 – LVDS CONNECTOR

If connecting the CED1 to a high-speed LVDS converter evaluation board, this connector should be used. The connector provides for four differential receive and four differential transmit data pairs in addition to separate differential receive

and transmit clocks. Control of any high-speed device is normally achieved over an interface separate to the data. For this purpose, the SPI and some parallel control signals are also routed over this connector. With the inclusion of three power supplies, this connector provides the flexibility to interface to many LVDS converters. Details of the pin-out of this connector are given in Table 1.

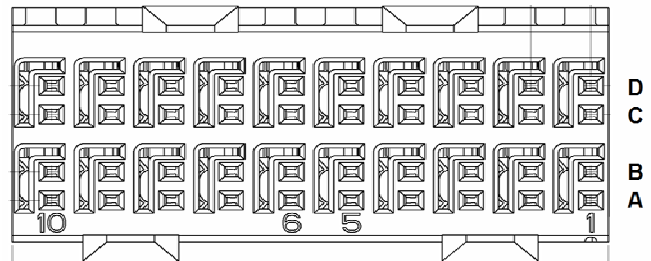

Figure 3. LVDS Connector pin locations

Table 1. LVDS Connector pin out

Pin Num	Pin Name	Description
1A, 1B	+VarA	Variable voltage analog power supply. See power supply section for more details.
1C, 1D	CLKOUT+/-	Differential Clock Output
2A	$\overline{\text{PAR\_CS0}}$	Parallel Chip Select 0
2B	$\overline{\text{PAR\_RD}}$	Parallel Read Strobe
C2-9, D2-7	Dx+/-	Differential Data Receive or Transmit Pair. By default the CED board is configured for 4 receive pairs (D0-3) and 4 transmit pairs (D4-7). These can be reconfigured by changing the termination resistors on the CED board. See schematics for more details.
A3-6	SPI_SELx	SPI Peripheral Chip Select
B3	$\overline{\text{PAR\_WR}}$	Parallel Write Strobe
B4	SPI_MISO	SPI Master In, Slave Out Data line
B5	SPI_MOSI	SPI Master Out, Slave In Data line
B6	SPI_CLK	SPI Clock
A7	TMR0/PPI_FS2	Timer 0 or Frame Sync 2 for PPI usage
B7	GPIO3/TMR1/PPI_FS1	General Purpose I/O, Timer 1 or Frame Sync 2 for PPI usage
A8	RXINT/GPIO2/PPI_FS3	Receive Interrupt, General Purpose I/O or Frame Sync 3 for PPI usage
B8	GPIO4/PAR_A0	General Purpose I/O or parallel address LSB
A9, B9	+3.3VD_Edge	+3.3V Digital power supply
A10, B10	+VarD	Variable voltage digital power supply. See power supply section for more details.
C10, D10	CLKIN+/-	Differential Clock Input pair

**J1 – MINI USB ‘B’ CONNECTOR**

This is used to connect the CED1 to the PC for control and data transfer

**J2 – 2-PIN SCREW TERMINAL POWER CONNECTOR**

This connector is used when powering the CED board with a lab supply. Care must be taken to ensure the external supply is connected with the correct polarity.

**J4 – DC POWER CONNECTOR**

When using the CED1 with the supplied power supply, the DC plug should be connected here. The polarity for this connector is centre positive.

**J6 – FPGA JTAG CONNECTOR**

This can be used with Altera SignalTap Logic Analyzer and appropriate hardware to assist with FPGA development and debug.

**J8, 9, 10 – 3× 90-WAY BLACKFIN EZ-KIT CONNECTORS**

These three connectors bring across most of the peripheral signals from the Blackfin Ez-Kit directly into the FPGA where

they can be used directly or rerouted to the other connectors. Additional processor or microcontroller boards could be designed and connected here if the user wished to add a processor to the design. See the Blackfin Ez-Kit manual for details of these connectors.

**J3 – 96-WAY DIN41612 CONNECTOR**

This connector has traditionally appeared on most precision ADC evaluation boards. It contains SPI, SPORT and Parallel signals as well as programmable digital and 5 separate analog power supplies. Pin out for this connector is shown in Table 2.

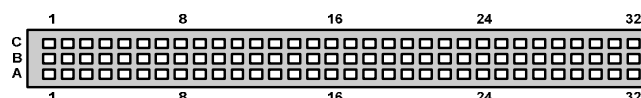

Figure 4. 96-way connector pin locations

Table 2. 96-way connector pin-out

Pin Num	Pin Name	Description
A1	SPORT_DT1PRI/ SPI_MOSI/PAR_D16	Sport1 Data Transmit Primary. SPI Master Out, Slave In data line. Parallel Data bit 16.
B1	GPIO3/TMR1/ PPI_FS1	General Purpose I/O bit 3. Timer 1. Parallel Peripheral Interface Frame Sync 1.
C1	SPORT_DR1PRI/ SPI_MISO/PAR_D19	Sport 1 Data Receive Primary. SPI Master In, Slave Out data line. Parallel Data bit 19.
A2	SPORT_TFS1/ SPI_SEL0/PAR_D17	Sport 1 Transmit Frame Sync. SPI Peripheral Chip Select 0. Parallel Data bit 17.
B2	PAR_D0	Parallel Data bit 0 (LSb)
C2	SPORT_RFS1/ SPI_SEL1/PAR_D20	Sport 1 Receive Frame Sync. SPI Peripheral Chip Select 1. Parallel Data bit 20.
A3	SPORT_TSCLK1/ SPI_CLK/PAR_D18	Sport 1 Transmit Serial Clock. SPI Clock. Parallel Data bit 18.
B3	PAR_D1	Parallel Data bit 1.
C3	SPORT_RSCLK1/ SPI_CLK/PAR_D21	Sport 1 Receive Clock. SPI Clock. Parallel Data bit 21.
A4, B4, C4	DGND	Digital Ground
A5	SPORT_DT0PRI/ SPI_SEL7	Sport 0 Data Transmit Primary. SPI Peripheral Chip Select 7
B5	PAR_D2	Parallel Data bit 2

<b>C5</b>	SPORT_DR0PRI/ SPI_SEL4	Sport 0 Data Receive Primary. SPI Peripheral Chip Select 4
<b>A6</b>	SPORT_TFS0/ SPI_SEL6	Sport 0 Transmit Frame Sync. SPI Peripheral Chip Select 6
<b>B6</b>	PAR_D3	Parallel Data bit 3
<b>C6</b>	SPORT_RFS0/ SPI_SEL3	Sport 0 Receive Frame Sync. SPI Peripheral Chip Select 3
<b>A7</b>	SPORT_TSCLK0/ SPI_SEL5	Sport 0 Transmit Serial Clock. SPI Peripheral Chip Select 5
<b>B7</b>	PAR_D4	Parallel Data bit 4
<b>C7</b>	SPORT_RSCLK0/ SPI_SEL2	SPORT 0 Receive Serial Clock. SPI Peripheral Chip Select 2
<b>A8, B8, C8</b>	+VarD (DV <sub>DD</sub> )	Variable Digital Power Supply. See Power Supply section for further details.
<b>A9</b>	PAR_RD	Parallel Read Strobe
<b>B9</b>	PAR_D5	Parallel Data bit 5
<b>C9</b>	PAR_WR	Parallel Write Strobe
<b>A10</b>	PAR_D22/PAR_A7	Parallel Data bit 22. Parallel Address bit 7 (MSb)
<b>B10</b>	PAR_D6	Parallel Data bit 5
<b>C10</b>	PAR_CS0	Parallel Chip Select 0
<b>A11</b>	SPORT_DT0SEC/ PAR_CS1/PAR_A5	Sport 0 Data Transmit Secondary. Parallel Chip Select 1. Parallel Address bit 5
<b>B11</b>	PAR_D7	Parallel Data bit 7
<b>C11</b>	GPIO6/PAR_D23/ PAR_A6	General Purpose I/O bit 6. Parallel Data bit 23. Parallel Address bit 6
<b>A12, B12, C12</b>	DGND	Digital Ground
<b>A13</b>	TWI_SDA/PAR_CS3/ PAR_A3	Two Wire Interface Serial Data. Parallel Chip Select 3. Parallel Address bit 3
<b>B13</b>	PAR_D8	Parallel Data bit 8
<b>C13</b>	SPORT_DR0SEC/ PAR_CS2/PAR_A4	Sport 0 Data Receive Secondary. Parallel Chip Select 2. Parallel Address bit 4
<b>A14</b>	GPIO5/PAR_A1	General Purpose I/O bit 5. Parallel Address bit 1
<b>B14</b>	PAR_D9	Parallel Data bit 9
<b>C14</b>	TWI_SCL/GPIO7/ PAR_A2	Two Wire Interface Serial Clock. General Purpose I/O bit 7 (MSb). Parallel Address bit 2
<b>A15</b>	GPIO0	General Purpose I/O bit 0 (LSb)
<b>B15</b>	PAR_D10	Parallel Data bit 10
<b>C15</b>	GPIO4/PAR_A0	General Purpose I/O bit 4. Parallel Address bit 0 (LSb)
<b>A16, B16, C16</b>	DGND	Digital Ground

<b>A17</b>	TMR0/PPI_FS2	Timer 0. Parallel Peripheral Interface Frame Sync 2
<b>B17</b>	PAR_D11	Parallel Data bit 11
<b>C17</b>	RXINT/GPIO2/ PPI_FS3	Receive Data Interrupt. General Purpose I/O bit 2. Parallel Peripheral Interface Frame Sync 3
<b>A18</b>	PAR_D12	Parallel Data bit 12
<b>B18</b>	PAR_D13	Parallel Data bit 13
<b>C18</b>	PAR_D14	Parallel Data bit 14
<b>A19</b>	CLKOUT	Clock Output
<b>B19</b>	GPIO1	General Purpose I/O bit 1
<b>C19</b>	PAR_D15	Parallel Data bit 15
<b>A20, B20, C20</b>	DGND	Digital Ground
<b>A21-26, B21-26, C21-26</b>	AGND	Analog Ground
<b>A27, C27</b>	+VarA	Variable Analog Power Supply. See Power Supply section for further details.
<b>B27</b>	AGND	Analog Ground
<b>A28</b>	N/C	No Connect. Do not use this pin.
<b>B28</b>	AGND	Analog Ground
<b>C28</b>	N/C	No Connect. Do not use this pin.
<b>A29, B29, C29</b>	AGND	Analog Ground
<b>A30</b>	-12VA	-12V Analog Power Supply. See Power Supply section for further details.
<b>B30</b>	AGND	Analog Ground
<b>C30</b>	+12VA	+12V Analog Power Supply. See Power Supply section for further details.
<b>A31, B31, C31</b>	-5VA (AV <sub>SS</sub> )	-5V Analog Power Supply. See Power Supply section for further details.
<b>A32, B32, C32</b>	+5VA (AV <sub>DD</sub> )	+5V Analog Power Supply. See Power Supply section for further details.

### J7 – ANALOG POWER CONNECTOR

If any analog power supplies are required on boards connected to the CED1 via any connector other than the J3 (96-way), they can be taken from this pin header. Pin-out details of this connector are given in Table 3. Further details of the power supplies are given in the following section.



Figure 5. Analog Power Connector Pin Locations

**Table 3. Analog Power Connector pin-out**

Pin No	Function	Description
1	+12VA_Edge	+12V Analog Supply
2	-12VA_Edge	-12V Analog Supply
3, 6, 8	AGND	Analog Ground
4	+5VA_Edge	+5V Analog Supply
5	-5VA_Edge	-5V Analog Supply
7	+VarA	Variable Voltage Analog Supply. See Power Supply Section for more details.

### J12 – SPORT INTERFACE

This standard two row, 0.1-inch connector can be used to connect any daughter board that utilizes the SPORT interface. This connector also contains all the SPI and Two Wire Interface (TWI) signals as well as 5V, 3.3V and the +7V CED board supply. See Table 4 for details. The pin-out of this connector is compatible with the Blackfin Stamp and Ez-Kit SPORT connector. More information on the pin names is given in the section detailing the 96-way connector.

**Table 4. SPORT Connector Pin out**

+5VD_Edge	1	2	+7V
DGND	3	4	N/C (Keying Pin)
RESET	5	6	SPORT_TSClk0/SPI_SEL5
SPORT_RFS0/SPI_SEL3	7	8	SPORT_DR0PRI/SPI_SEL4
DGND	9	10	SPORT_DR0SEC
SPORT_TFS0/SPI_SEL6	11	12	SPORT_DT0SEC
+3.3VD_Edge	13	14	SPORT_DT0PRI/SPI_SEL7
+3.3VD_Edge	15	16	SPORT_RSCLk0/SPI_SEL2
SPI_SS	17	18	SPI_MOSI
SPI_SEL1	19	20	SPI_MISO
SPI_SEL2	21	22	SPI_CLK
SPI_SEL3	23	24	TWI_SDA
SPI_SEL4	25	26	TWI_SCK
SPI_SEL5	27	28	RXINT/GPIO2/PPI_FS3
SPI_SEL6	29	30	GPIO3/TMR1/PPI_FS1
SPI_SEL7	31	32	TMR0/PPI_FS2
DGND	33	34	DGND



### J13 – SPI INTERFACE

Using the SPI connector instead of the SPORT should only be considered when the user is satisfied that the device being connected is completely compatible with the SPI specification. This implies that only 8- or 16-bit active low framing is required. See Table 5 for pin-out details of this connector. This connector is compatible with the SPI connector on the Blackfin Stamp and Ez-Kits. More information on the pin names is given in the section detailing the 96-way connector.

**Table 5. SPI Connector Pin out**

+5VD_Edge	<b>1</b>	<b>2</b>	+3.3VD_Edge
+5VD_Edge	<b>3</b>	<b>4</b>	+3.3VD_Edge
SPI_MOSI	<b>5</b>	<b>6</b>	SPI_MISO
RESET	<b>7</b>	<b>8</b>	SPI_CLK
SPI_SEL1	<b>9</b>	<b>10</b>	SPI_SS
SPI_SEL3	<b>11</b>	<b>12</b>	SPI_SEL2
SPI_SEL5	<b>13</b>	<b>14</b>	SPI_SEL4
SPI_SEL7	<b>15</b>	<b>16</b>	SPI_SEL6
N/C (Keying Pin)	<b>17</b>	<b>18</b>	DGND
+7V	<b>19</b>	<b>20</b>	DGND

### J14 – PPI INTERFACE

This connector is intended to allow attachment of daughter boards designed to connect to the PPI Connector on the Blackfin Stamp and Ez-Kit. However, with the signals provided, it should be possible to connect to most parallel interface devices needing up to 16 data bits and multiple control signals.

The inclusion of the SPI signals on this connector allows for separate data and configuration interfaces if required. See Table 6 for details of this connector. More information on the pin names is given in the section detailing the 96-way connector.

**Table 6. PPI Connector Pin out**

+5VD_Edge	<b>1</b>	<b>2</b>	+7V
+5VD_Edge	<b>3</b>	<b>4</b>	N/C (Keying Pin)
+3.3VD_Edge	<b>5</b>	<b>6</b>	CLKOUTP_EXT
+3.3VD_Edge	<b>7</b>	<b>8</b>	PAR_D0
PAR_D1	<b>9</b>	<b>10</b>	PAR_D2
PAR_D3	<b>11</b>	<b>12</b>	PAR_D4
PAR_D5	<b>13</b>	<b>14</b>	PAR_D6
PAR_D7	<b>15</b>	<b>16</b>	PAR_D8
PAR_D9	<b>17</b>	<b>18</b>	PAR_D10
PAR_D11	<b>19</b>	<b>20</b>	PAR_D12
PAR_D13	<b>21</b>	<b>22</b>	PAR_D14
PAR_D15	<b>23</b>	<b>24</b>	SPI_SEL3
SPI_SEL2	<b>25</b>	<b>26</b>	SPI_SEL1
SPI_SS	<b>27</b>	<b>28</b>	RESET
RxInt/GPIO2/PPI_FS3	<b>29</b>	<b>30</b>	SPI_MOSI
GPIO3/TMR1/PPI_FS1	<b>31</b>	<b>32</b>	SPI_MISO
TMR0/PPI_FS2	<b>33</b>	<b>34</b>	SPI_CLK
DGND	<b>35</b>	<b>36</b>	TWI_SDA
DGND	<b>37</b>	<b>38</b>	TWI_SCK
DGND	<b>39</b>	<b>40</b>	DGND

### CONNECTOR PART NUMBERS

**Table 7. Connector Part Numbers**

Ref. Des.	Description	Manufacturer	Part Number	Mating Connector
J1	USB Mini-B connector	Molex	565790576	Standard Mini-B USB Cable
J2	2-pin screw terminal	Camden Electronics	CTB5000/2	Cables inserted directly
J3	96-Way 90° DIN41612 socket	Harting	0973 296 6801	0903 196 6921
J4	DC Barrel connector, 2mm centre	Kycon	KLDX-SMT2-0202-A	Cliff - DCPPI (FC68147)
J5	LVDS connector	Tyco Electronics	1469028-1	1469169-1
J6	10-Pin, 2 row standard 0.1" pitch header	Harwin	M20-8760542	M20-7830546
J8-10	90-way Micro-strip Terminal	Samtec	TFC-145-X2-FD-A	SFC-145-T2-FD-A
J12	34-Pin, 2 row standard 0.1" pitch header	Harwin	M20-8761742	M20-7831746
J13	20-Pin, 2 row standard 0.1" pitch header	Harwin	M20-8761042	M20-7831046
J14	40-Pin, 2 row standard 0.1" pitch header	Harwin	M20-8762042	M20-7832046

**POWER SUPPLIES**

The CED board provides multiple power supplies that are made available for use with connected boards. A single 7V supply is required for the CED board and this is used to power the board itself and the supplies for boards connected to it. A resettable 2A fuse limits the current that can be drawn from the supply thus limiting the power consumption of the CED and any attached boards.

On it's own without any converter boards attached, the idle current of the CED is approximately 220 mA. When accessing SRAM for example, the current drawn by the CED board itself can increase significantly. Users designing boards to operate with the CED that wish to use the supplies provided must bear in mind the total available power when calculating their power requirements.

While the supplies generated on the CED are kept as clean as possible, designers of boards connected to the CED must ensure that all devices and supplies are adequately decoupled. This will prevent noise being fed back onto the power supplies of the CED. Excessive noise introduced on to the power supplies may cause the CED or attached boards to malfunction.

The voltage and current ratings of the supplies listed in Table 8 are defined to be absolute maximum limits. While fuses and thermal overload protection have been provided in the power supply circuitry, attempting to draw more current from a particular supply or exceeding the total power available from a combination of supplies may cause damage to the CED board.

**Table 8. Power Supplies**

<b>Name</b>	<b>Voltage</b>	<b>Max. Current</b>	<b>Test Conditions / Comments</b>
+VarA	+1.5V to +5.5V	300mA	Regulation may suffer at lower voltages.
-12VA	-12V ±5%	100mA	Fuse limited at 100mA.
+12VA	+12V ±5%	100mA	Fuse limited at 100mA.
-5VA	-5V ±5%	100mA	Fuse limited at 100mA.
+5VA	+5V ±5%	500mA	Regulator rated for 500mA but thermally limited.
+5VD	+5V ±5%	500mA	Regulator rated for 500mA but thermally limited.
+3.3VD	+3.3V ±5%	300mA	Thermally limited.
+VarD	+1.5V to +5.5V	300mA	Regulation may suffer at lower voltages.
+7V	+7V ±5%	2A	Total current that can be drawn through board including all other supplies. Fuse limited.

SCHEMATICS

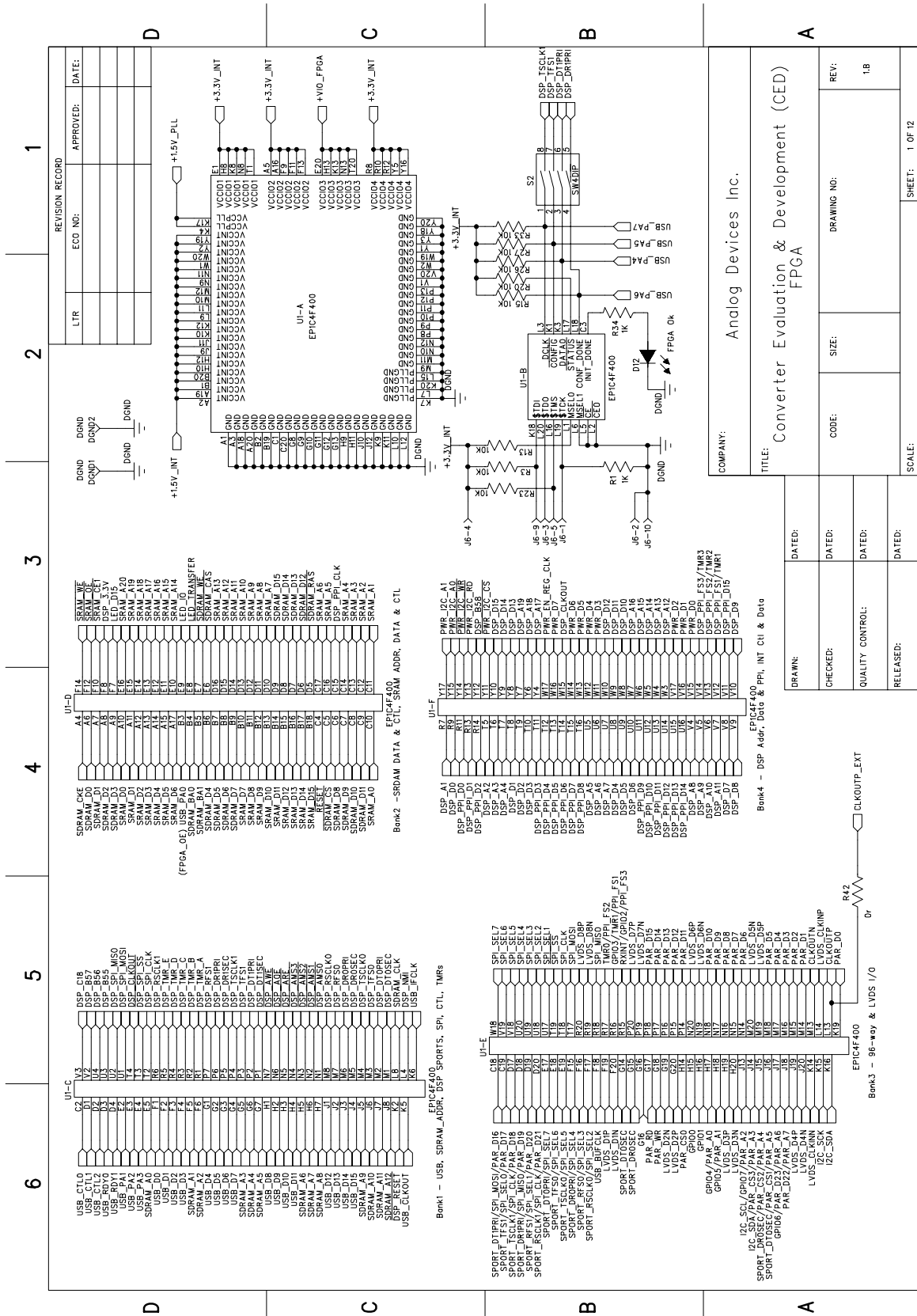

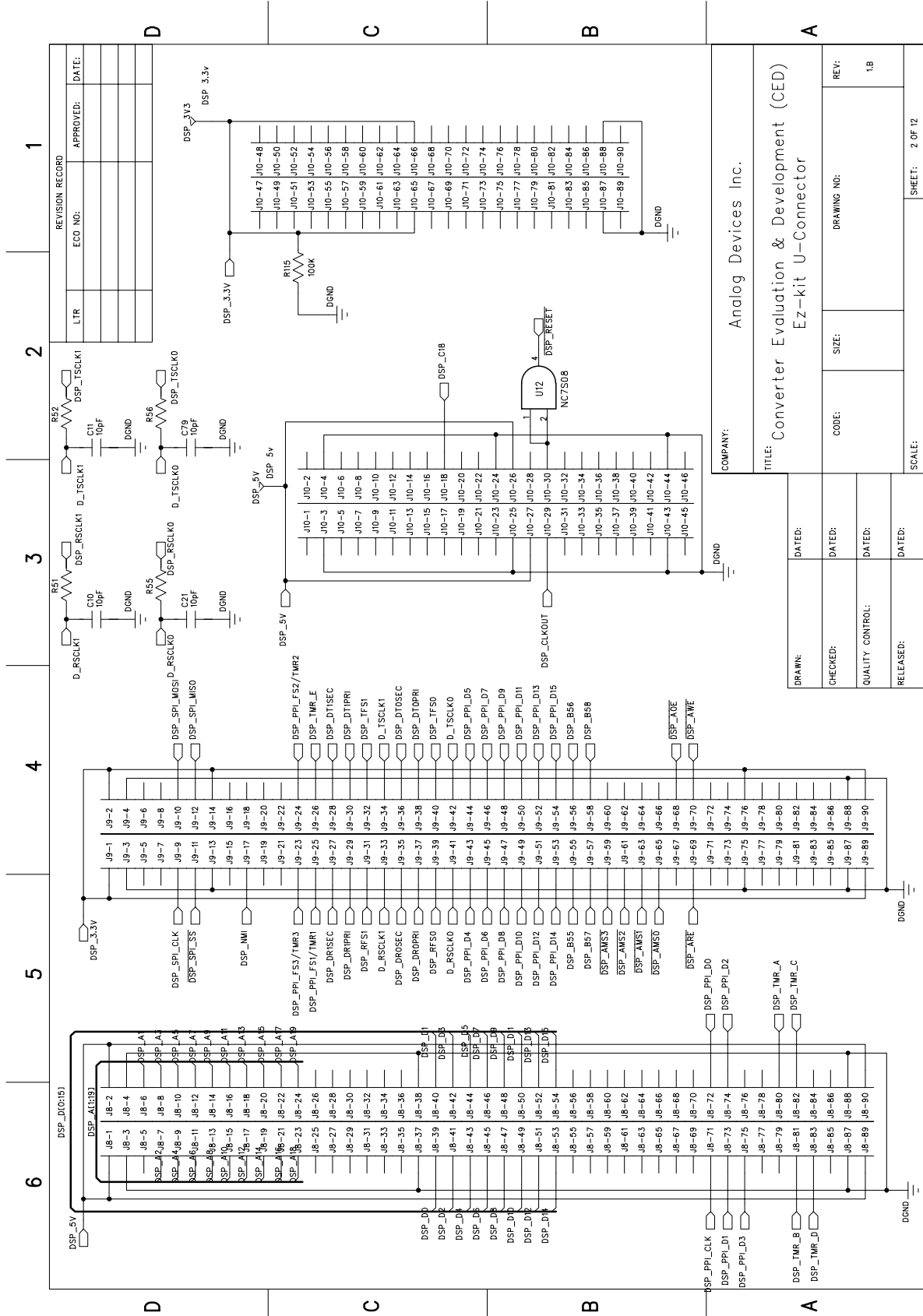

REVISION RECORD		
LTR	ECC NO:	APPROVED:
		DATE:

1		
2		
3		
4		
5		
6		

DSP_5V	DSP_3.3V	DSP_3.3V
DSP_5V	DSP_3.3V	DSP_3.3V
DSP_5V	DSP_3.3V	DSP_3.3V
DSP_5V	DSP_3.3V	DSP_3.3V
DSP_5V	DSP_3.3V	DSP_3.3V
DSP_5V	DSP_3.3V	DSP_3.3V

DSP_5V	DSP_3.3V	DSP_3.3V
DSP_5V	DSP_3.3V	DSP_3.3V
DSP_5V	DSP_3.3V	DSP_3.3V
DSP_5V	DSP_3.3V	DSP_3.3V
DSP_5V	DSP_3.3V	DSP_3.3V
DSP_5V	DSP_3.3V	DSP_3.3V

DSP_5V	DSP_3.3V	DSP_3.3V
DSP_5V	DSP_3.3V	DSP_3.3V
DSP_5V	DSP_3.3V	DSP_3.3V
DSP_5V	DSP_3.3V	DSP_3.3V
DSP_5V	DSP_3.3V	DSP_3.3V
DSP_5V	DSP_3.3V	DSP_3.3V

DSP_5V	DSP_3.3V	DSP_3.3V
DSP_5V	DSP_3.3V	DSP_3.3V
DSP_5V	DSP_3.3V	DSP_3.3V
DSP_5V	DSP_3.3V	DSP_3.3V
DSP_5V	DSP_3.3V	DSP_3.3V
DSP_5V	DSP_3.3V	DSP_3.3V

DSP_5V	DSP_3.3V	DSP_3.3V
DSP_5V	DSP_3.3V	DSP_3.3V
DSP_5V	DSP_3.3V	DSP_3.3V
DSP_5V	DSP_3.3V	DSP_3.3V
DSP_5V	DSP_3.3V	DSP_3.3V
DSP_5V	DSP_3.3V	DSP_3.3V

DSP_5V	DSP_3.3V	DSP_3.3V
DSP_5V	DSP_3.3V	DSP_3.3V
DSP_5V	DSP_3.3V	DSP_3.3V
DSP_5V	DSP_3.3V	DSP_3.3V
DSP_5V	DSP_3.3V	DSP_3.3V
DSP_5V	DSP_3.3V	DSP_3.3V

DSP_5V	DSP_3.3V	DSP_3.3V
DSP_5V	DSP_3.3V	DSP_3.3V
DSP_5V	DSP_3.3V	DSP_3.3V
DSP_5V	DSP_3.3V	DSP_3.3V
DSP_5V	DSP_3.3V	DSP_3.3V
DSP_5V	DSP_3.3V	DSP_3.3V

DSP_5V	DSP_3.3V	DSP_3.3V
DSP_5V	DSP_3.3V	DSP_3.3V
DSP_5V	DSP_3.3V	DSP_3.3V
DSP_5V	DSP_3.3V	DSP_3.3V
DSP_5V	DSP_3.3V	DSP_3.3V
DSP_5V	DSP_3.3V	DSP_3.3V

COMPANY:		Analog Devices Inc.	
TITLE:			
Converter Evaluation & Development (CED)			
Ez-kit U-Connector			
DRAWN:	DATED:	CODE:	SIZE:
CHECKED:	DATED:	QUALITY CONTROL:	DATED:
RELEASED:	DATED:	SCALE:	SHEET: 2 OF 12

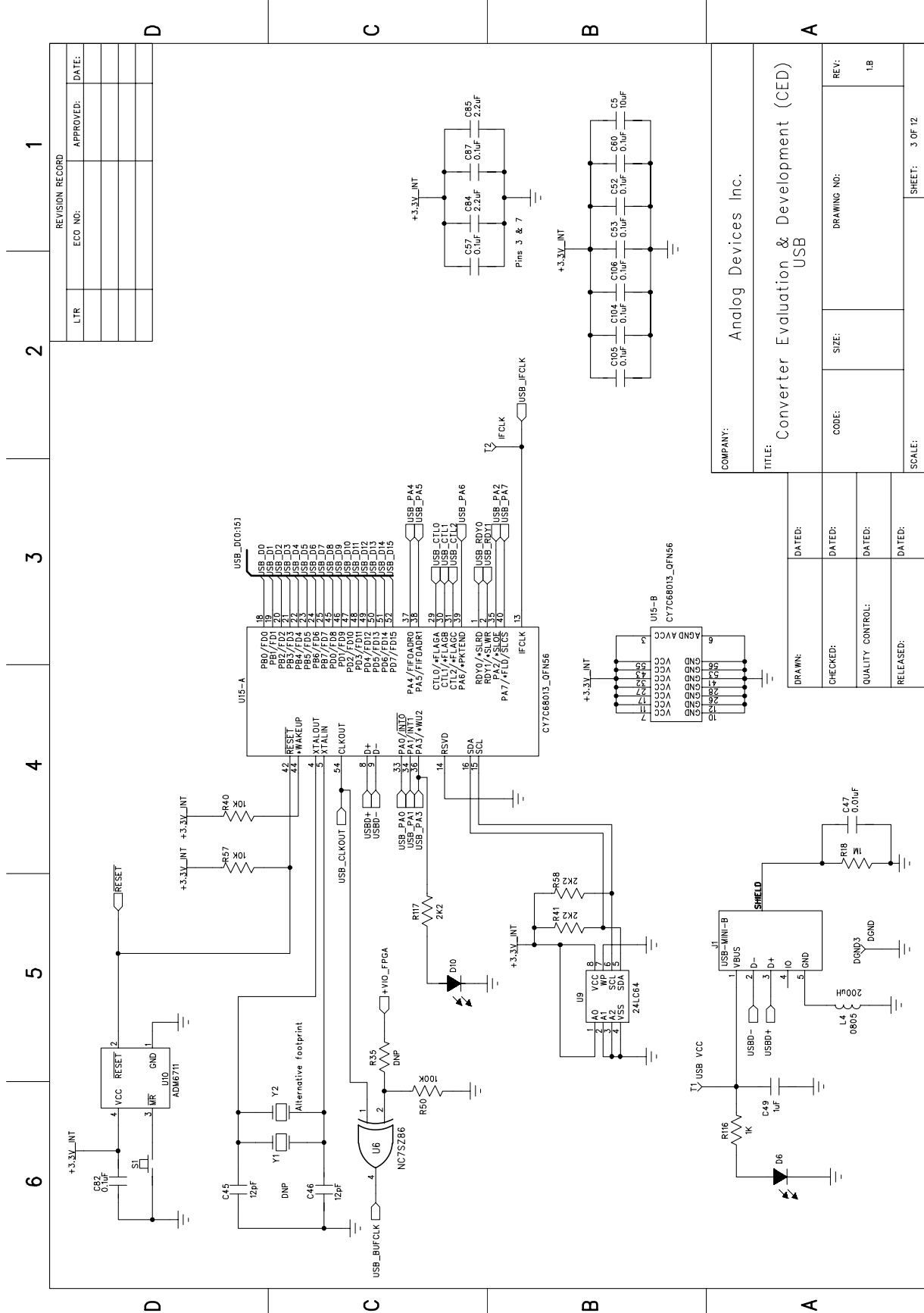





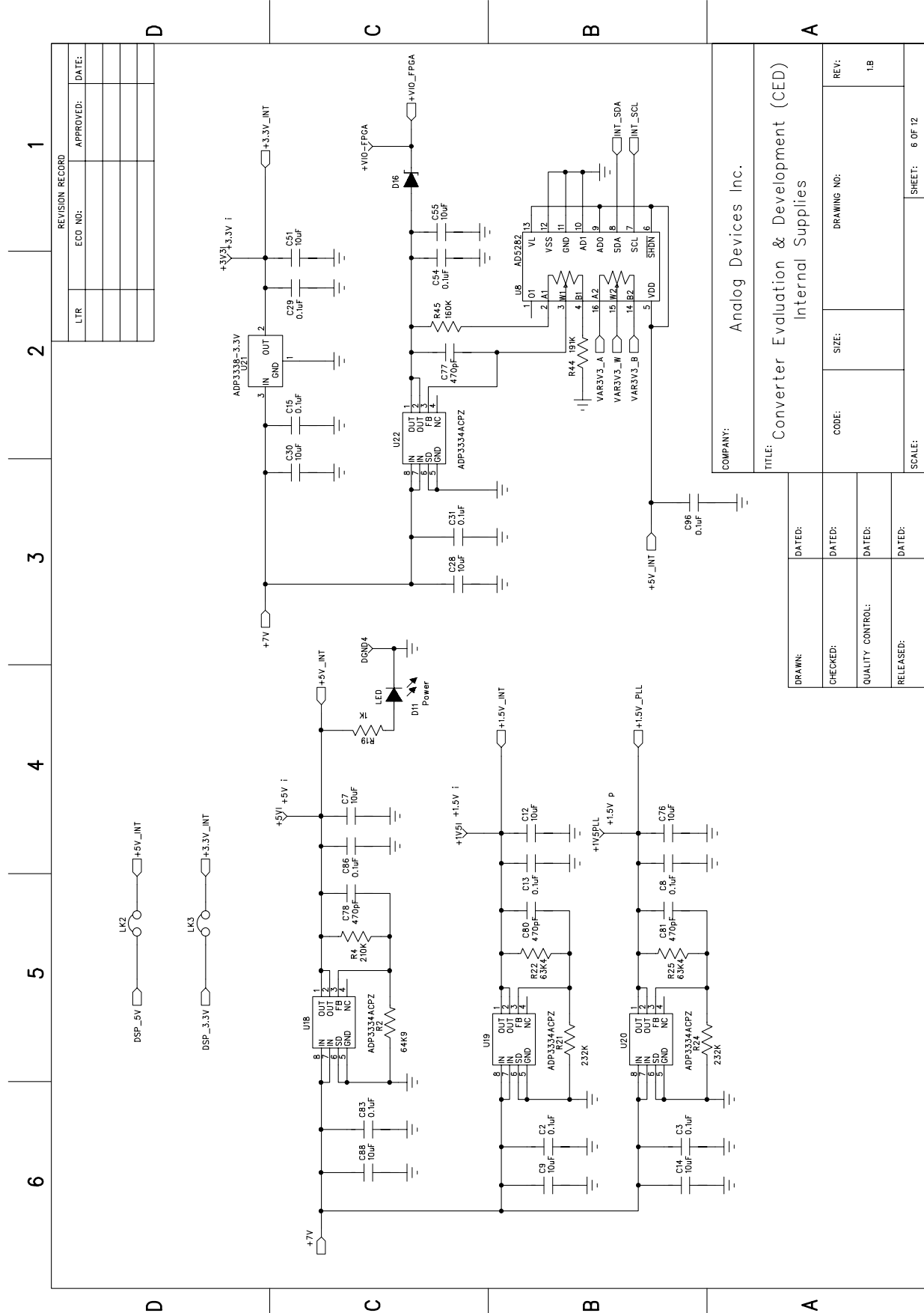

REVISION RECORD		
LTR	ECCO NO:	DATE:

COMPANY:		Analog Devices Inc.	
TITLE:		Converter Evaluation & Development (CED) Internal Supplies	
DRAWN:	DATED:	CODE:	SIZE:
CHECKED:	DATED:		
QUALITY CONTROL:	DATED:		
RELEASED:	DATED:		
		DRAWING NO:	REV:
			1B
		SCALE:	SHEET: 6 OF 12



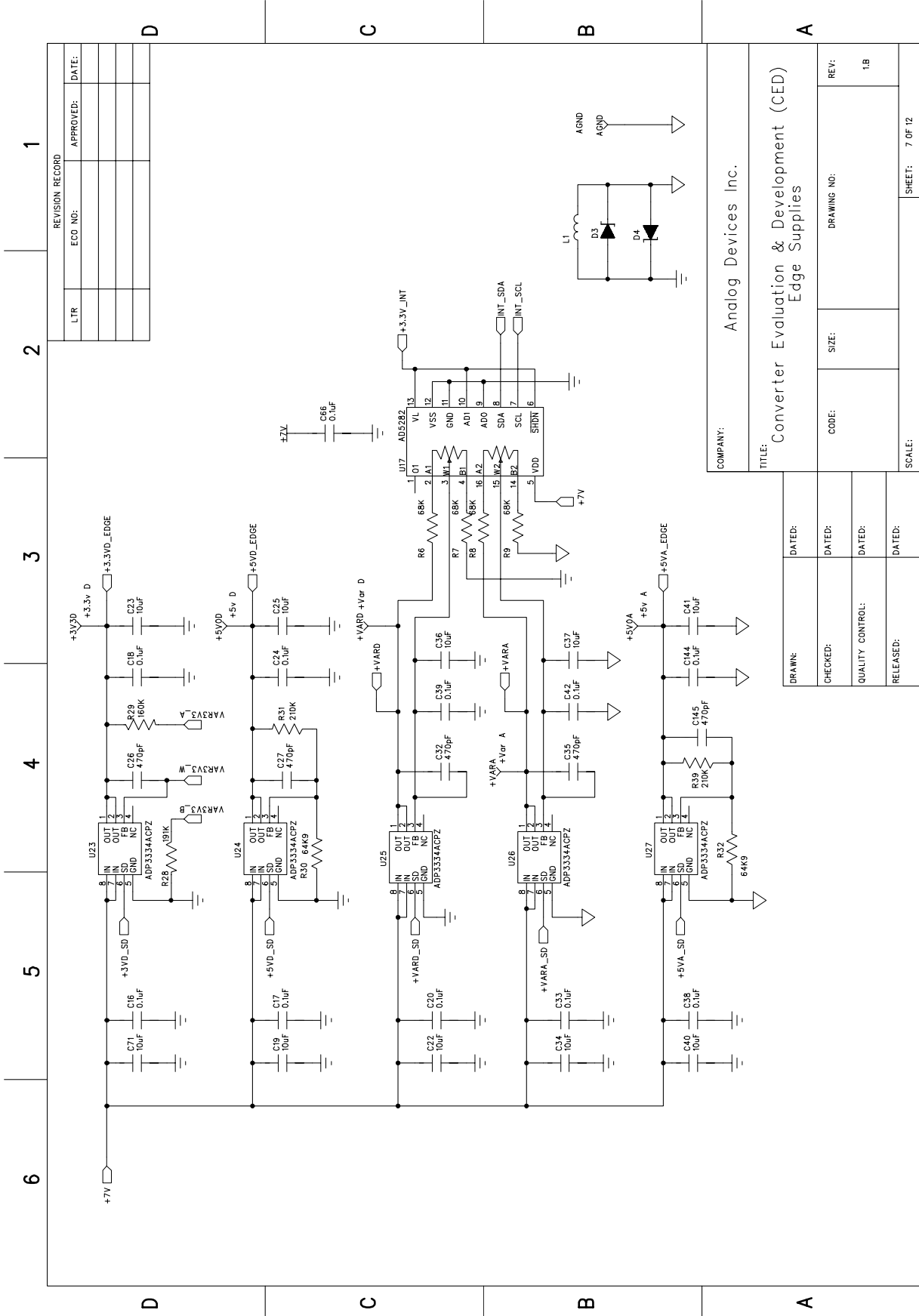

REVISION RECORD		
LTR	ECO NO.	APPROVED: DATE:

COMPANY: Analog Devices Inc.	
TITLE: Converter Evaluation & Development (CED) Edge Supplies	
DRAWN:	DATED:
CHECKED:	DATED:
QUALITY CONTROL:	DATED:
RELEASED:	DATED:
CODE:	SIZE:
DRAWING NO:	
REV: 1.B	
SCALE:	SHEET: 7 OF 12

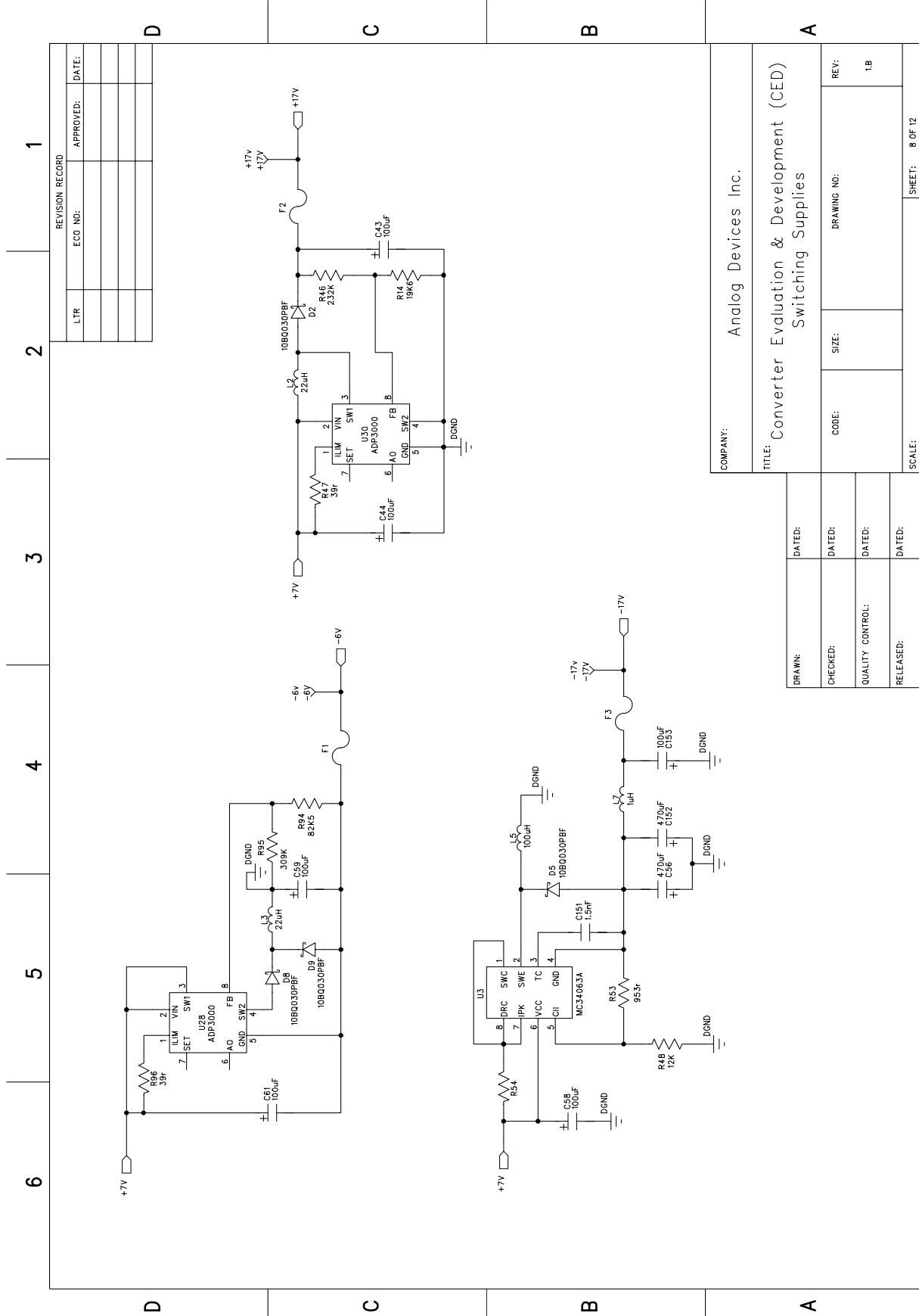

COMPANY:		Analog Devices Inc.	
TITLE:		Converter Evaluation & Development (CED) Switching Supplies	
DRAWN:	DATED:	CODE:	SIZE:
CHECKED:	DATED:	DRAWING NO.:	REVY:
QUALITY CONTROL:	DATED:		1.B
RELEASED:	DATED:	SCALE:	8 OF 12

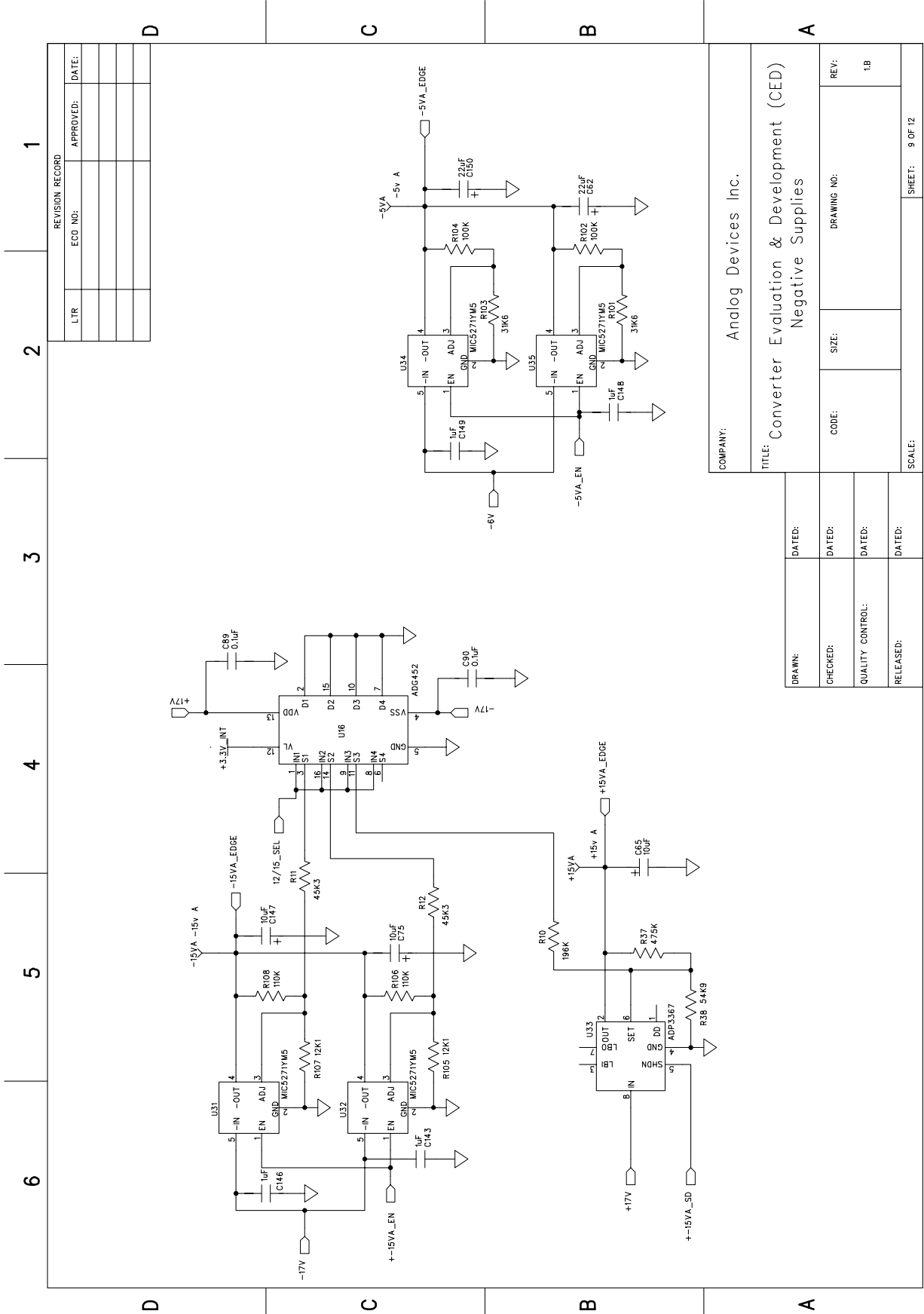

REVISION RECORD	
LTR	APPROVED: DATE:
ECO NO:	

COMPANY: Analog Devices Inc.	
TITLE: Converter Evaluation & Development (CED) Negative Supplies	
DRAWN:	DATED:
CHECKED:	DATED:
QUALITY CONTROL:	DATED:
RELEASED:	DATED:
CODE:	SIZE:
DRAWING NO:	REV: 1B
SCALE:	SHEET: 9 OF 12

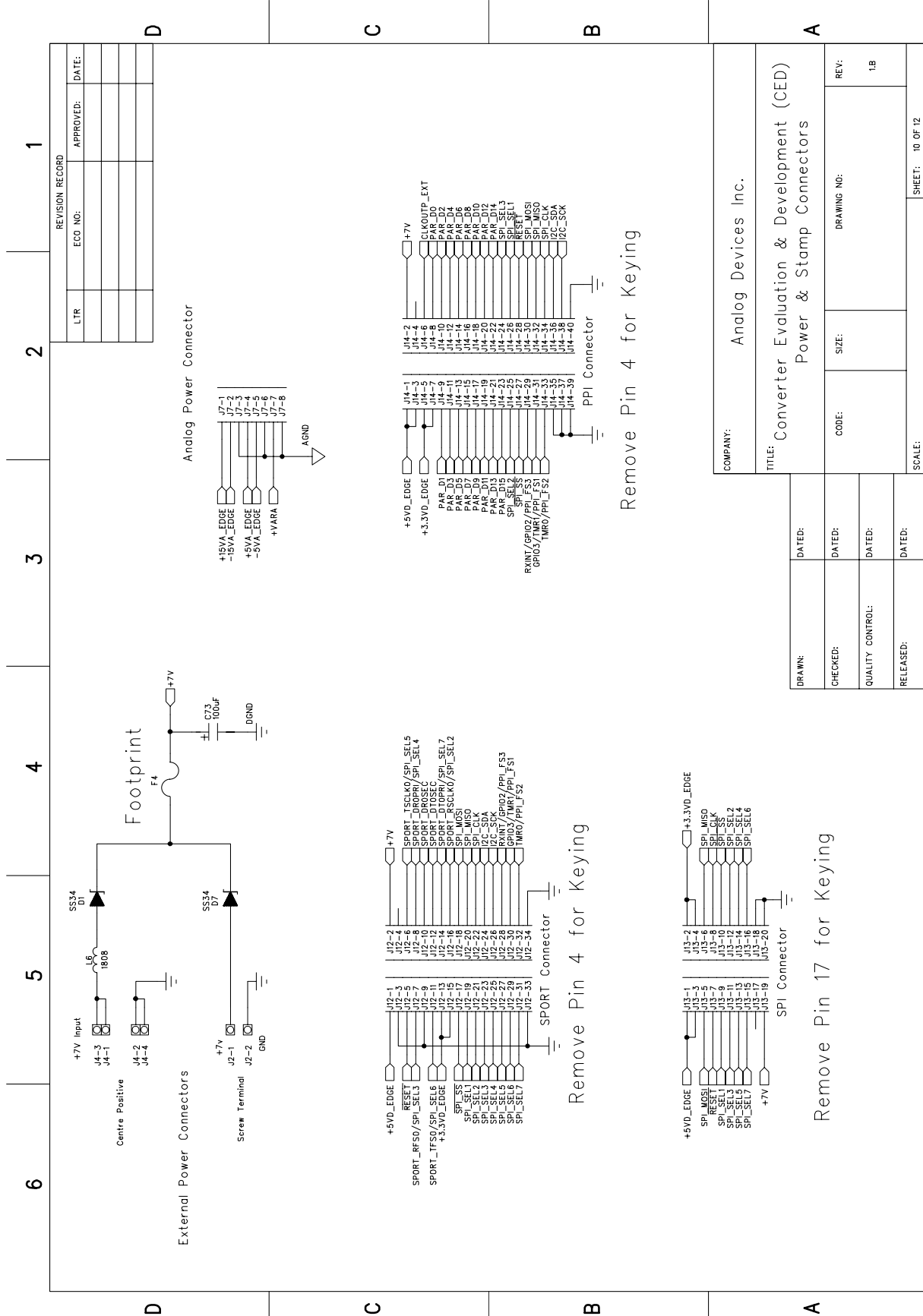

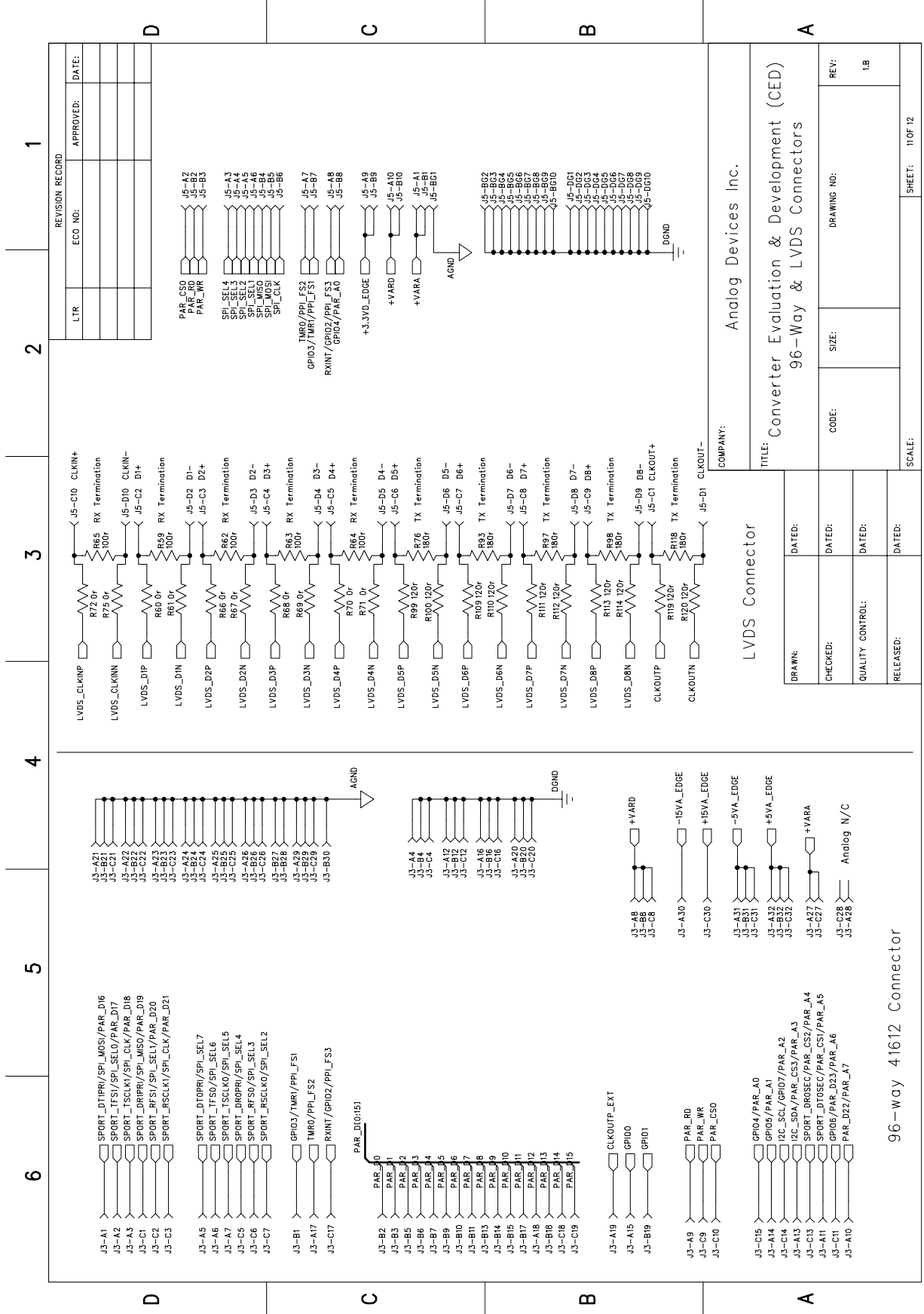

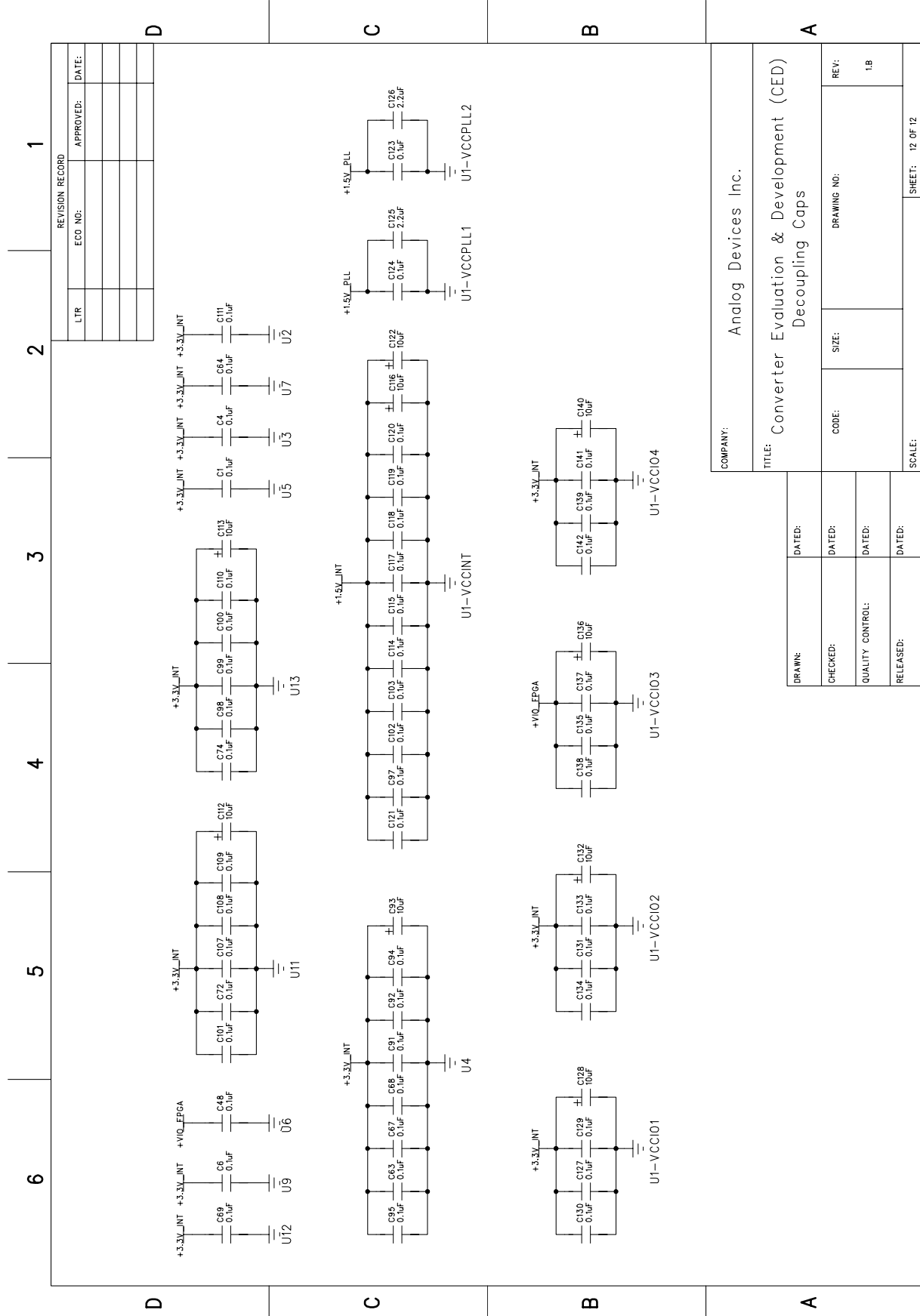

REVISION RECORD	
LTR	DATE:
ECO NO:	APPROVED:

COMPANY: Analog Devices Inc.	
TITLE: Converter Evaluation & Development (CED) Decoupling Caps	
DRAWN:	DATED:
CHECKED:	DATED:
QUALITY CONTROL:	DATED:
RELEASED:	DATED:
CODE:	SIZE:
DRAWING NO:	REV:
	1.B
SCALE:	SHEET: 12 OF 12



Ordering Information

**ORDERING GUIDE**

Model	Description
EVAL-CED1Z <sup>1</sup>	Converter Evaluation and Development Board

<sup>1</sup> Z = RoHS Compliant Part.

**ESD CAUTION**



**ESD (electrostatic discharge) sensitive device.** Charged devices and circuit boards can discharge without detection. Although this product features patented or proprietary protection circuitry, damage may occur on devices subjected to high energy ESD. Therefore, proper ESD precautions should be taken to avoid performance degradation or loss of functionality.





Компания «ЭлектроПласт» предлагает заключение долгосрочных отношений при поставках импортных электронных компонентов на взаимовыгодных условиях!

Наши преимущества:

- Оперативные поставки широкого спектра электронных компонентов отечественного и импортного производства напрямую от производителей и с крупнейших мировых складов;
- Поставка более 17-ти миллионов наименований электронных компонентов;
- Поставка сложных, дефицитных, либо снятых с производства позиций;
- Оперативные сроки поставки под заказ (от 5 рабочих дней);
- Экспресс доставка в любую точку России;
- Техническая поддержка проекта, помощь в подборе аналогов, поставка прототипов;
- Система менеджмента качества сертифицирована по Международному стандарту ISO 9001;
- Лицензия ФСБ на осуществление работ с использованием сведений, составляющих государственную тайну;
- Поставка специализированных компонентов (Xilinx, Altera, Analog Devices, Intersil, Interpoint, Microsemi, Aeroflex, Peregrine, Syfer, Eurofarad, Texas Instrument, Miteq, Cobham, E2V, MA-COM, Hittite, Mini-Circuits, General Dynamics и др.);

Помимо этого, одним из направлений компании «ЭлектроПласт» является направление «Источники питания». Мы предлагаем Вам помощь Конструкторского отдела:

- Подбор оптимального решения, техническое обоснование при выборе компонента;
- Подбор аналогов;
- Консультации по применению компонента;
- Поставка образцов и прототипов;
- Техническая поддержка проекта;
- Защита от снятия компонента с производства.



#### Как с нами связаться

**Телефон:** 8 (812) 309 58 32 (многоканальный)

**Факс:** 8 (812) 320-02-42

**Электронная почта:** [org@eplast1.ru](mailto:org@eplast1.ru)

**Адрес:** 198099, г. Санкт-Петербург, ул. Калинина, дом 2, корпус 4, литера А.