

General specifications

Layout

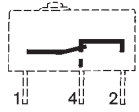

Components

Material

- Case : polyester UL 94 VO
- Button : glass-filled polyamide
- Contacts : AgNi, gold-plated AgNi (dual-current)
- Terminals : copper-nickel

Actuators

- flat : stainless steel
- roller : stainless steel with polyamide roller

Approvals: NF - UL - cUL

Operating curve

For type 83 170 0

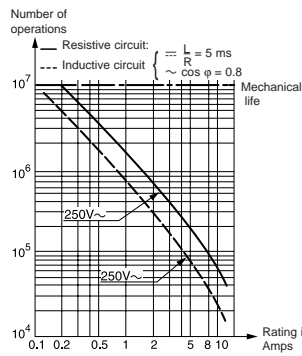

For type 83 170 4

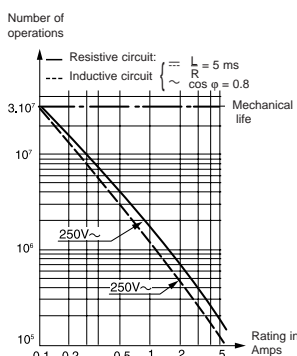

For type 83 170 9

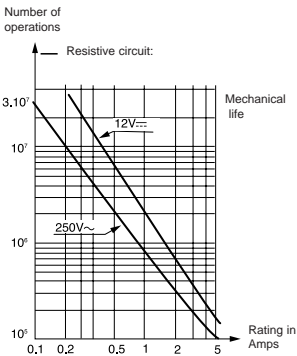

Model 83 170 9 is designed to operate equally well on dual-current (1 mA 4 V minimum) or medium-current (5 A maximum) circuits. However, a given product should only be used to switch one type of circuit during its working life.

Types

Part numbers for standard products (no lever) terminal type	
	1
	2
	3

Features

Electrical characteristics

	Nominal	A
Current rating at 250 V		
	Thermal	A

Mechanical characteristics

Operating force - max.	N (oz.)
Release force - min.	N (oz.)
Total travel force - max.	N (oz.)
Permitted overtravel force - max.	N (oz.)
Maximum rest position	mm (in.)
Tripping point	mm (in.)
Differential travel	mm (in.)
Overtravel - min.	mm (in.)
Ambient operating temperature	°C
Mechanical endurance	Operations
Contact gap	mm (in.)
Weight	g (oz.)

Contact type

- C** (Form C) SPDT
- B** (Form B) SPNC not available in PC terminals
- A** (Form A) SPNO not available in PC terminals

Connections

Actuators and mounting positions

Part numbers for standard actuators

Actuators – Length	mm (in.)
--------------------	----------

Mounting positions

Coefficient	
Tripping point	mm (in.)

Mounting positions

Except where otherwise indicated, actuators are supplied unmounted. For factory mounting, specify mounting position L or R.

- **To calculate force** : take the force quoted for the switch and divide by the coefficient given in the table.
- **To calculate travel** : take the travel quoted for the switch and multiply by the same coefficient.

Mounting accessories for PCB mounting: 5 / 6 / 7 / 8

See page 3/9.

Other information

For other forces, actuators, connections and temperatures, please consult us.

Normally stocked items

Catalog products produced to order

Products and specifications subject to change without notice.

Order/Technical Support – Tel: (800) 677-5311 / FAX: (800) 677-3865 / www.crouzet-usa.com

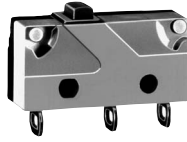

1

83170.0	83170.4	83170.9	83170.4 SP 4967	83170.4	83170.9
831700C1.0	831704C1.0	831709C1.0	831704C2.MBSP	831704C1.MB	831709C1.MB
831700C2.0	831704C2.0	831709C2.0	831704C3.MBSP	831704C2.MB	831709C2.MB
831700C3.0	831704C3.0	831709C3.0	831704C1.MBSP	831704C3.MB	831709C3.MB
High current	Standard	Low current	High force	Standard	Low current
10	5	0.1	5	5	0.1
12.5	6		6	6	
1.5 (5.3)	0.6 (2.2)	0.6 (2.2)	1.5 (5.3)	0.6 (2.2)	0.6 (2.2)
0.3 (1)	0.1 (.04)	0.1 (.04)	0.3 (1)	0.1 (.04)	0.1 (.04)
1.8 (6.3)	1 (3.5)	1 (3.5)	1.8 (6.3)	1 (3.5)	1 (3.5)
10 (35.3)	10 (35.3)	10 (35.3)	10 (35.3)	10 (35.3)	10 (35.3)
9.2 (.36)	9.2 (.36)	9.2 (.36)	10.8 (.425)	10.8 (.425)	10.8 (.425)
8.4 ^{+0.3} (.33 ^{+0.01})	8.4 ^{+0.3} (.33 ^{+0.01})	8.4 ^{+0.3} (.33 ^{+0.01})	9.9 ^{+0.3} (.39 ^{+0.01})	9.9 ^{+0.3} (.39 ^{+0.01})	9.9 ^{+0.3} (.39 ^{+0.01})
0.15 (.006)	0.15 (.006)	0.15 (.006)	0.15 (.006)	0.15 (.006)	0.15 (.006)
0.5 (.02)	0.5 (.02)	0.5 (.02)	0.5 (.02)	0.5 (.02)	0.5 (.02)
-20 to130 (-4 to 266)	-20 to130 (-4 to 266)	-20 to130 (-4 to 266)	-20 to130 (-4 to 266)	-20 to130 (-4 to 266)	-20 to130 (-4 to 266)
10 ⁷	3.10 ⁷	3.10 ⁷	10 ⁶	10 ⁶	10 ⁶
0.4 (.016)	0.4 (.016)	0.4 (.016)	0.4 (.016)	0.4 (.016)	0.4 (.016)
1.7 (.06)	1.7 (.06)	1.7 (.06)	1.7 (.06)	1.7 (.06)	1.7 (.06)

2

C	C	C	C	C	C
B	B	B	B	B	B
A	A	A	A	A	A

3

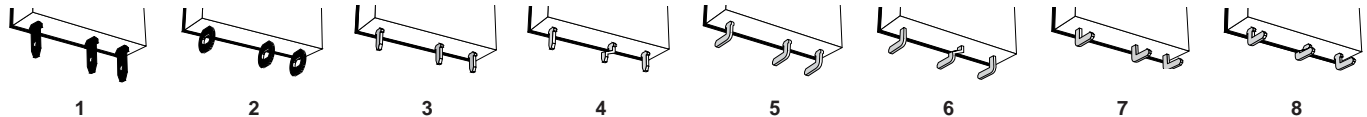

4

A 79 253 327	B 79 253 326	C 79 253 328	E 79 218 454	F 79 253 329
Flat 170A R18.3 (.72)	Flat 170A R24 (.94)	Flat 170A R41 (1.61)	Roller 170E R20 (.79)	Dummy roller 170F R19.5 (.77)
L 3 10.4 ^{+1.2} (.41 ^{+0.05})	L 4 11.1 ^{+1.2} (.44 ^{+0.05})	L 7 13.2 ^{+2.5} (.52 ⁺¹)	L 3 15.4 ^{+1.2} (.61 ^{+0.05})	L 3 13 ^{+1.2} (.51 ^{+0.05})
R 1.5 9.2 ^{+0.6} (.36 ^{+0.24})	R 2 9.6 ^{+0.6} (.38 ^{+0.24})	R 3.5 10.7 ^{+1.2} (.42 ^{+0.05})	R 1.5 14.5 ^{+0.6} (.57 ^{+0.24})	R 1.5 12 ^{+0.6} (.47 ^{+0.24})

D 79 218 491	L 79 218 493
Screw 170D R20 (.79)	Transverse roller 170L R20 (.79)
Characteristics available upon request.	

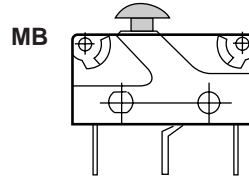

Ø No Actuator

5

To order please specify :

Example : 831700 C 2 . C L				
1 Switch Type	2 Contact Type	3 Connection	4 Actuators	5 Actuator Position
831700 831704 831709	A B C	1 5 2 6 3 7 4 8	A E B F C L D MB Ø MB SP4967	L - Left (Standard) R - Right
To order actuators separately, use the 8 digit P/N			Example P/N is 831700 SPDT solder terminals "C" actuator mounted on the left.	

Products and specifications subject to change without notice.

Order/Technical Support – Tel: (800) 677-5311 / FAX: (800) 677-3865 / www.crouzet-usa.com

Subminiature Switches DIN 41635 B

Dimensions

83 170 Asymmetric

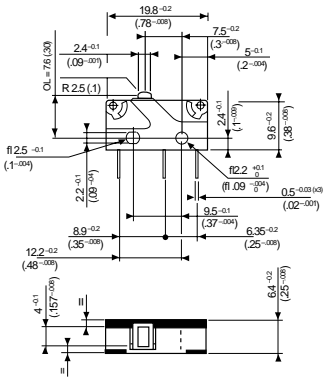

83 170 Symmetric

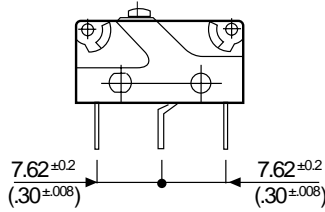

83 170 with MB Button

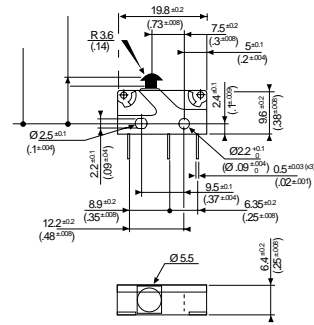

Mounting by M2 screws
Torque : 2 cm daN

mm (in)

Connections

- 2
Solder
- 1
.11x.02 Quick Connects
- 3-4
Straight PCB
- 5-6
Side Output PCB Rear
- 7-8
Side Output PCB Front

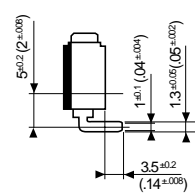
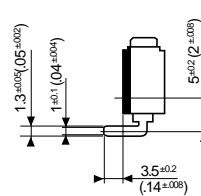
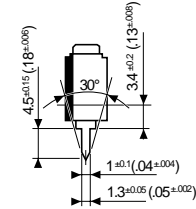
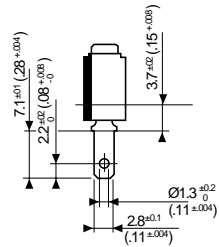
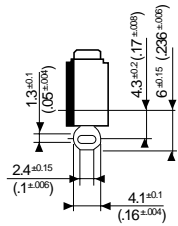

Printed circuit board mounting

Asymmetric

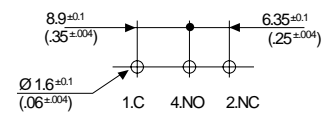

Symmetric

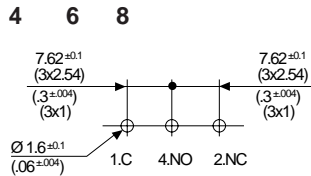

mm (in)

Products and specifications subject to change without notice.

Order/Technical Support – Tel: (800) 677-5311 / FAX: (800) 677-3865 / www.crouzet-usa.com

Actuators

Actuator mounting positions

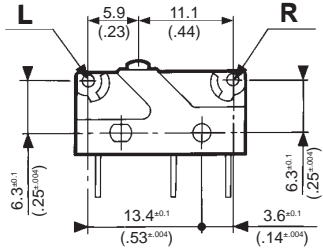

A B C

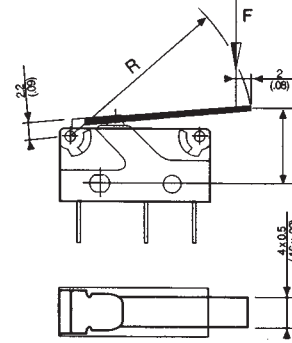

TP (Tripping Point)
Refer to pages 3/6 & 3/7.

E

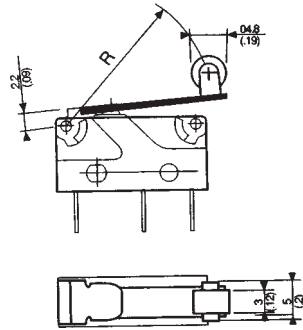

F

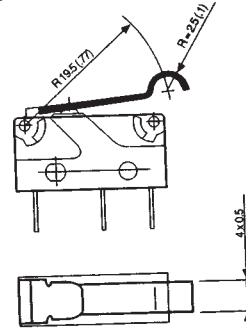

mm (in.)

Mounting accessories

Mounting pins

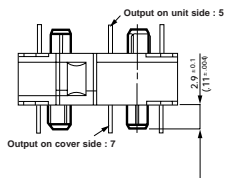

mm (in.)

Products and specifications subject to change without notice.

Order/Technical Support – Tel: (800) 677-5311 / FAX: (800) 677-3865 / www.crouzet-usa.com



Компания «ЭлектроПласт» предлагает заключение долгосрочных отношений при поставках импортных электронных компонентов на взаимовыгодных условиях!

Наши преимущества:

- Оперативные поставки широкого спектра электронных компонентов отечественного и импортного производства напрямую от производителей и с крупнейших мировых складов;
- Поставка более 17-ти миллионов наименований электронных компонентов;
- Поставка сложных, дефицитных, либо снятых с производства позиций;
- Оперативные сроки поставки под заказ (от 5 рабочих дней);
- Экспресс доставка в любую точку России;
- Техническая поддержка проекта, помощь в подборе аналогов, поставка прототипов;
- Система менеджмента качества сертифицирована по Международному стандарту ISO 9001;
- Лицензия ФСБ на осуществление работ с использованием сведений, составляющих государственную тайну;
- Поставка специализированных компонентов (Xilinx, Altera, Analog Devices, Intersil, Interpoint, Microsemi, Aeroflex, Peregrine, Syfer, Eurofarad, Texas Instrument, Miteq, Cobham, E2V, MA-COM, Hittite, Mini-Circuits, General Dynamics и др.);

Помимо этого, одним из направлений компании «ЭлектроПласт» является направление «Источники питания». Мы предлагаем Вам помощь Конструкторского отдела:

- Подбор оптимального решения, техническое обоснование при выборе компонента;
- Подбор аналогов;
- Консультации по применению компонента;
- Поставка образцов и прототипов;
- Техническая поддержка проекта;
- Защита от снятия компонента с производства.



Как с нами связаться

Телефон: 8 (812) 309 58 32 (многоканальный)

Факс: 8 (812) 320-02-42

Электронная почта: org@eplast1.ru

Адрес: 198099, г. Санкт-Петербург, ул. Калинина, дом 2, корпус 4, литера А.