

# Oven Controlled Crystal Oscillators

AOCJYR-24.576MHz-M5834LF



ESD Sensitive



RoHS / RoHS II Compliant

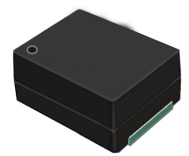

9.7 x 7.5 x 4.3 mm SMD

## Moisture Sensitivity Level (MSL) – 1

### OVERVIEW:

Abrakon's AOCJYR series of World's Smallest Profile, Surface Mount- Ovenized Quartz Crystal Oscillators are based on Proprietary Mercury™ ASIC technology, patented by Rakon. This Advanced Technology coupled with Rakon's proprietary manufacturing techniques enable  $\pm 10$  ppb stability over  $-20^{\circ}\text{C}$  to  $+70^{\circ}\text{C}$ , with typical short-term aging of better than  $\pm 2$  ppb per day.

Sophisticated Integrated Oven Control architecture ensures fast warm-up time, while minimizes initial power consumption to 350mW typical at  $25^{\circ}\text{C}$ . Further, the integration of critical functionality improves overall product reliability by reducing FIT rates 10x relative to traditional discrete OCXOs.

The AOCJYR series is offered in Industry leading 9.7 x 7.5 x 4.3 mm SMT package, while AOCJYR-DIL is available in 21.7 x 13.08 x 8.6 mm leaded hermetic package.

### FEATURES:

- Compact package size: 9.7 x 7.5 x 4.3mm
- Frequency stability over temperature as low as  $\pm 25$ ppb over  $-40$  to  $+85^{\circ}\text{C}$
- Low power consumption
- High reliability

### APPLICATIONS:

- Stratum 3
- Small Cells
- Switches and Routers
- Time & Frequency References
- SyncE and IEEE 1588

### STANDARD SPECIFICATIONS:

Parameters	Minimum	Typical	Maximum	Units	Notes
Nominal Frequency	24.576			MHz	
Supply Voltage (Vdd)	3.135	3.3	3.465	V	
Input Power (warm-up)		1000		mW	
Input Power (steady-state)			400	mW	@ $25^{\circ}\text{C}$ still air
Operable Temperature Range	-40		85	$^{\circ}\text{C}$	
Storage Temperature Range	-55		+125	$^{\circ}\text{C}$	
Initial Frequency Tolerance @ $25^{\circ}\text{C}$ At time of shipment			$\pm 0.5$	ppm	See Note 1
Reflow Shift			$\pm 1$	ppm	After 1hr recovery
Frequency Stability over Operating Temperature Range in Still Air			$\pm 25$	ppb	Ref. to $(F_{\text{MAX}}+F_{\text{MIN}})/2$
Slope in Still Air			$\pm 2$	ppb/ $^{\circ}\text{C}$	Temperature ramp $1^{\circ}\text{C}/\text{minute max.}$
Holdover Stability			$\pm 4$	ppb	24hrs, temperature variation $\leq \pm 1^{\circ}\text{C}$ . See Note 2
Free-run Accuracy			$\pm 4.6$	ppm	All causes, 20 years life, ref. to nominal frequency.
Stability vs. Supply Voltage Change		$\pm 10$		ppb	$\pm 5\%$ variation in Vdd, ref. to freq. @Vdd=3.3V
Load Coefficient		$\pm 10$		ppb	$\pm 5$ pF variation in load, ref. to freq. @ 15pF load
Frequency Aging (per day)			$\pm 2$	ppb	See Note 2

# Oven Controlled Crystal Oscillators

AOCJYR-24.576MHz-M5834LF



ESD Sensitive



RoHS / RoHS II Compliant

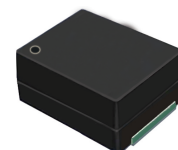

9.7 x 7.5 x 4.3 mm SMD

## STANDARD SPECIFICATIONS CONTINUED:

Parameters		Minimum	Typical	Maximum	Units	Notes
Frequency Aging (long-term stability)	First Year			±1	ppm	
	20 Years			±3	ppm	
Warm-up Time			<3		minute	See Note 3
Root Allan Variance			<1x10 <sup>-10</sup>			@25°C, τ=1.0s
Acceleration Sensitivity			<2		ppb/g	Gamma vector of all 3 axes from 30Hz to 1500Hz
Output Type		LVCMOS				
High-level Output Voltage (V <sub>OH</sub> )		90%*V <sub>dd</sub>			V	
Low-level Output Voltage (V <sub>OL</sub> )				10%*V <sub>dd</sub>	V	
Output Load		10	15	20	pF	
Rise and Fall Time (t <sub>r</sub> , t <sub>f</sub> )				4	ns	
Duty Cycle		45		55	%	
Phase Noise @ 24.576MHz Carrier						
@ 1	Hz offset		-55		dBc / Hz	
@ 10	Hz offset		-83		dBc / Hz	
@ 100	Hz offset		-109		dBc / Hz	
@ 1,000	Hz offset		-130		dBc / Hz	
@ 10,000	Hz offset		-146		dBc / Hz	
@ 100,000	Hz offset		-149		dBc / Hz	
@ 1,000,000	Hz offset		-150		dBc / Hz	

Note:

1. The characteristics of the component may be temporarily affected by the processes of assembly and soldering. The frequency specifications apply 48 hours after assembly. Nominal conditions apply unless otherwise stated.
2. After 30 days of continuous operation.
3. Time needed for frequency to be within ±20ppb reference to frequency after 1hour, at 25°C. Parameter is assembly and operating history dependent

## CROSS REFERENCE INFORMATION:

AOCJYR-24.576MHz-M5834LF is equivalent to Rakon P/N M5834LF.

# Oven Controlled Crystal Oscillators

AOCJYR-24.576MHz-M5834LF



ESD Sensitive



RoHS / RoHS II Compliant

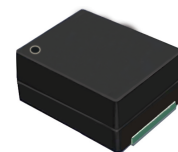

9.7 x 7.5 x 4.3 mm SMD

## PART IDENTIFICATION:

AOCJYR- 24.576MHz -M5834LF -

### Packing

Blank: Bulk

T: Tape & Reel (1k/reel)

## OUTLINE DIMENSION:

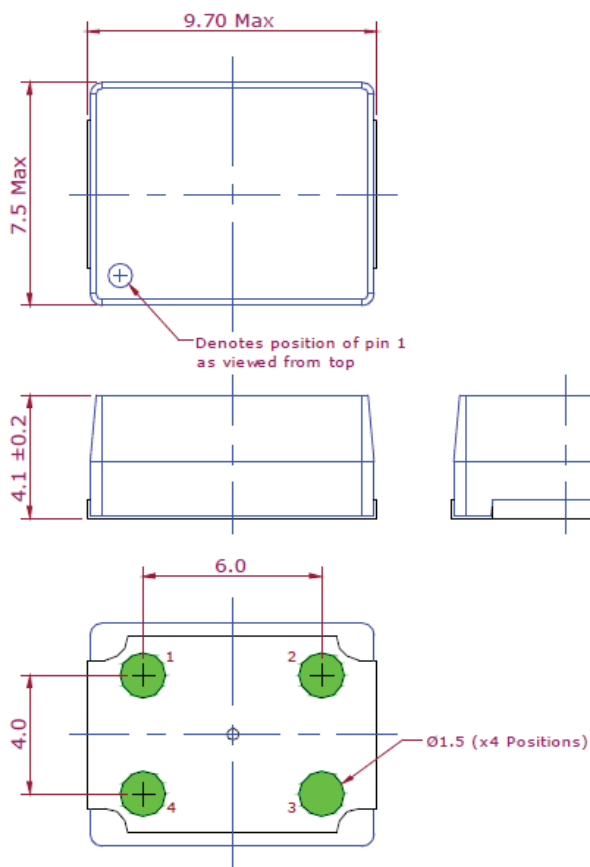

### Recommended Land Pattern

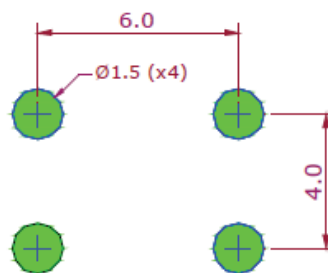

Pin	Function
1	NC
2	Ground
3	RF-output
4	Supply Voltage

Note: For correct operation, decouple the supply voltage with a 10µF capacitor close to the oscillator.

Dimension: mm

# Oven Controlled Crystal Oscillators



9.7 x 7.5 x 4.3 mm SMD

AOCJYR-24.576MHz-M5834LF



ESD Sensitive



RoHS / RoHS II Compliant

## REFLOW PROFILE:

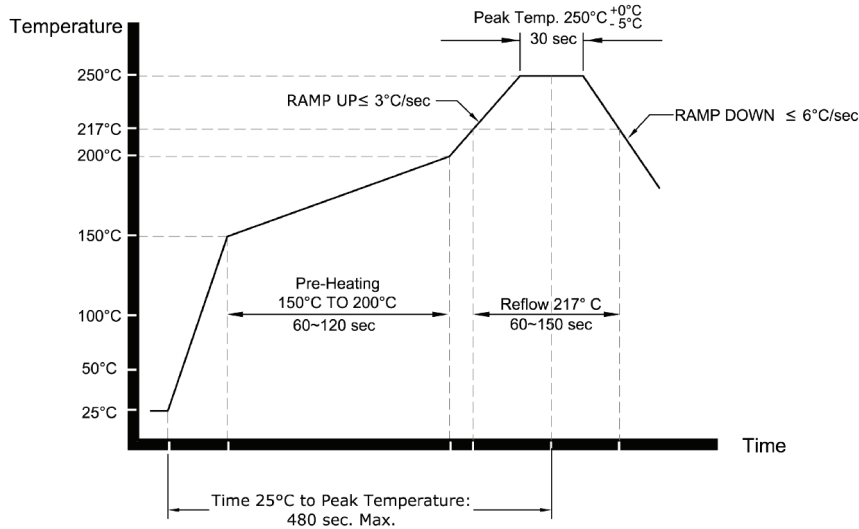

## TAPE & REEL:

Packaging: 1000pcs/reel

Reel Size: Ø13"

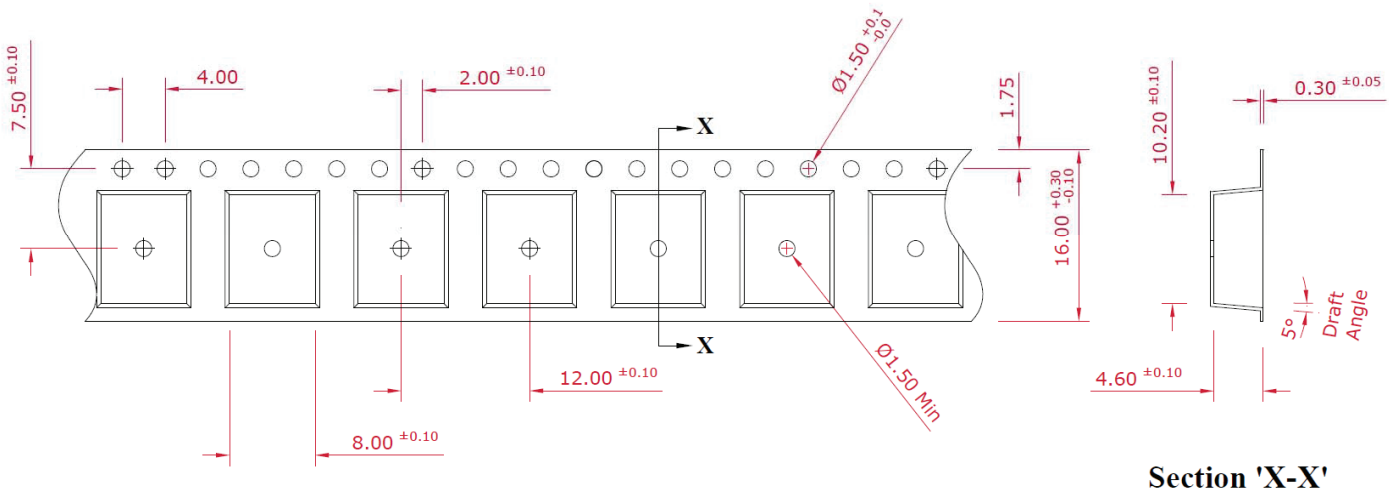

Dimension: mm

**ATTENTION:** Abracon Corporation's products are COTS – Commercial-Off-The-Shelf products; suitable for Commercial, Industrial and, where designated, Automotive Applications. Abracon's products are not specifically designed for Military, Aviation, Aerospace, Life-dependant Medical applications or any application requiring high reliability where component failure could result in loss of life and/or property. For applications requiring high reliability and/or presenting an extreme operating environment, written consent and authorization from Abracon Corporation is required. Please contact Abracon Corporation for more information.

ABRACON IS  
ISO9001:2008  
CERTIFIED



**ABRACON**  
CORPORATION

Visit [www.abracon.com](http://www.abracon.com) for Terms & Conditions of Sale

30332 Esperanza, Rancho Santa Margarita, California 92688  
tel 949-546-8000 | fax 949-546-8001 | [www.abracon.com](http://www.abracon.com)

Revised: 08.19.14



Компания «ЭлектроПласт» предлагает заключение долгосрочных отношений при поставках импортных электронных компонентов на взаимовыгодных условиях!

Наши преимущества:

- Оперативные поставки широкого спектра электронных компонентов отечественного и импортного производства напрямую от производителей и с крупнейших мировых складов;
- Поставка более 17-ти миллионов наименований электронных компонентов;
- Поставка сложных, дефицитных, либо снятых с производства позиций;
- Оперативные сроки поставки под заказ (от 5 рабочих дней);
- Экспресс доставка в любую точку России;
- Техническая поддержка проекта, помощь в подборе аналогов, поставка прототипов;
- Система менеджмента качества сертифицирована по Международному стандарту ISO 9001;
- Лицензия ФСБ на осуществление работ с использованием сведений, составляющих государственную тайну;
- Поставка специализированных компонентов (Xilinx, Altera, Analog Devices, Intersil, Interpoint, Microsemi, Aeroflex, Peregrine, Syfer, Eurofarad, Texas Instrument, Miteq, Cobham, E2V, MA-COM, Hittite, Mini-Circuits, General Dynamics и др.);

Помимо этого, одним из направлений компании «ЭлектроПласт» является направление «Источники питания». Мы предлагаем Вам помощь Конструкторского отдела:

- Подбор оптимального решения, техническое обоснование при выборе компонента;
- Подбор аналогов;
- Консультации по применению компонента;
- Поставка образцов и прототипов;
- Техническая поддержка проекта;
- Защита от снятия компонента с производства.



#### Как с нами связаться

**Телефон:** 8 (812) 309 58 32 (многоканальный)

**Факс:** 8 (812) 320-02-42

**Электронная почта:** [org@eplast1.ru](mailto:org@eplast1.ru)

**Адрес:** 198099, г. Санкт-Петербург, ул. Калинина, дом 2, корпус 4, литера А.