

# MBRD320G, MBRD330G, MBRD340G, MBRD350G, MBRD360G

## Switch-mode Power Rectifiers

### DPAK Surface Mount Package

These state-of-the-art devices are designed for use as output rectifiers, free wheeling, protection and steering diodes in switching power supplies, inverters and other inductive switching circuits.

#### Features

- Extremely Fast Switching
- Extremely Low Forward Drop
- Platinum Barrier with Avalanche Guardrings
- NRVBD and SBRD Prefixes for Automotive and Other Applications Requiring Unique Site and Control Change Requirements; AEC-Q101 Qualified and PPAP Capable
- These Devices are Pb-Free, Halogen Free/BFR Free and are RoHS Compliant

#### Mechanical Characteristics:

- Case: Epoxy, Molded
- Weight: 0.4 Gram (Approximately)
- Finish: All External Surfaces Corrosion Resistant and Terminal Leads are Readily Solderable
- Lead and Mounting Surface Temperature for Soldering Purposes; 260°C Max. for 10 Seconds
- ESD Ratings:
  - ◆ Machine Model = C
  - ◆ Human Body Model = 3B



ON Semiconductor®

[www.onsemi.com](http://www.onsemi.com)

### SCHOTTKY BARRIER RECTIFIERS 3.0 AMPERES, 20 – 60 VOLTS

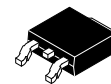

DPAK  
CASE 369C

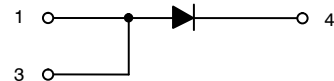

#### MARKING DIAGRAM

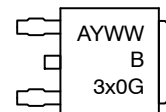

|      |                      |
|------|----------------------|
| A    | = Assembly Location* |
| Y    | = Year               |
| WW   | = Work Week          |
| B3x0 | = Device Code        |
| x    | = 2, 3, 4, 5, or 6   |
| G    | = Pb-Free Package    |

\* The Assembly Location Code (A) is front side optional. In cases where the Assembly Location is stamped in the package bottom (molding ejecter pin), the front side assembly code may be blank.

#### ORDERING INFORMATION

See detailed ordering and shipping information in the package dimensions section on page 3 of this data sheet.

# MBRD320G, MBRD330G, MBRD340G, MBRD350G, MBRD360G

## MAXIMUM RATINGS

| Rating   | Symbol                          | MBRD/SBRD8  |     |     |     |     | Unit             |
|--|---------------------------------|-------------|-----|-----|-----|-----|------------------|
|  |                                 | 320         | 330 | 340 | 350 | 360 |                  |
| Peak Repetitive Reverse Voltage<br>Working Peak Reverse Voltage<br>DC Blocking Voltage                     | $V_{RRM}$<br>$V_{RWM}$<br>$V_R$ | 20          | 30  | 40  | 50  | 60  | V                |
| Average Rectified Forward Current ( $T_C = +125^\circ\text{C}$ , Rated $V_R$ )                             | $I_{F(AV)}$                     | 3           |     |     |     |     | A                |
| Peak Repetitive Forward Current, $T_C = +125^\circ\text{C}$<br>(Rated $V_R$ , Square Wave, 20 kHz)         | $I_{FRM}$                       | 6           |     |     |     |     | A                |
| Nonrepetitive Peak Surge Current<br>(Surge applied at rated load conditions halfwave, single phase, 60 Hz) | $I_{FSM}$                       | 75          |     |     |     |     | A                |
| Peak Repetitive Reverse Surge Current (2 $\mu\text{s}$ , 1 kHz)  | $I_{RRM}$                       | 1           |     |     |     |     | A                |
| Operating Junction Temperature Range (Note 1)  | $T_J$                           | -65 to +175 |     |     |     |     | $^\circ\text{C}$ |
| Storage Temperature Range  | $T_{stg}$                       | -65 to +175 |     |     |     |     | $^\circ\text{C}$ |
| Voltage Rate of Change (Rated $V_R$ )  | $dv/dt$                         | 10,000      |     |     |     |     | V/ $\mu\text{s}$ |

Stresses exceeding those listed in the Maximum Ratings table may damage the device. If any of these limits are exceeded, device functionality should not be assumed, damage may occur and reliability may be affected.

1. The heat generated must be less than the thermal conductivity from Junction-to-Ambient:  $dP_D/dT_J < 1/R_{\theta JA}$ .

## THERMAL CHARACTERISTICS

| Characteristic   | Symbol          | Value | Unit                      |
|--|-----------------|-------|---------------------------|
| Maximum Thermal Resistance, Junction-to-Case             | $R_{\theta JC}$ | 6     | $^\circ\text{C}/\text{W}$ |
| Maximum Thermal Resistance, Junction-to-Ambient (Note 2) | $R_{\theta JA}$ | 80    | $^\circ\text{C}/\text{W}$ |

2. Rating applies when surface mounted on the minimum pad size recommended.

## ELECTRICAL CHARACTERISTICS

| Characteristic   | Symbol | Value                       | Unit |
|--|--------|-----------------------------|------|
| Maximum Instantaneous Forward Voltage (Note 3)<br>$i_F = 3$ Amps, $T_C = +25^\circ\text{C}$<br>$i_F = 3$ Amps, $T_C = +125^\circ\text{C}$<br>$i_F = 6$ Amps, $T_C = +25^\circ\text{C}$<br>$i_F = 6$ Amps, $T_C = +125^\circ\text{C}$ | $V_F$  | 0.6<br>0.45<br>0.7<br>0.625 | V    |
| Maximum Instantaneous Reverse Current (Note 3)<br>(Rated dc Voltage, $T_C = +25^\circ\text{C}$ )<br>(Rated dc Voltage, $T_C = +125^\circ\text{C}$ )  | $i_R$  | 0.2<br>20                   | mA   |

Product parametric performance is indicated in the Electrical Characteristics for the listed test conditions, unless otherwise noted. Product performance may not be indicated by the Electrical Characteristics if operated under different conditions.

3. Pulse Test: Pulse Width = 300  $\mu\text{s}$ , Duty Cycle  $\leq 2.0\%$ .

# MBRD320G, MBRD330G, MBRD340G, MBRD350G, MBRD360G

## ORDERING INFORMATION

| Device            | Package           | Shipping†         |
|-------------------|-------------------|-------------------|
| MBRD320G          | DPAK<br>(Pb-Free) | 75 Units / Rail   |
| SBRD8320G*        |                   | 75 Units / Rail   |
| SBRD8320G-VF01*   |                   | 75 Units / Rail   |
| MBRD320RLG        |                   | 1,800 Tape & Reel |
| MBRD320T4G        |                   | 2,500 Tape & Reel |
| SBRD8320T4G*      |                   | 2,500 Tape & Reel |
| SBRD8320T4G-VF01* |                   | 2,500 Tape & Reel |
| MBRD330G          |                   | 75 Units / Rail   |
| SBRD8330G*        |                   | 75 Units / Rail   |
| SBRD8330G-VF01*   |                   | 75 Units / Rail   |
| MBRD330RLG        |                   | 1,800 Tape & Reel |
| MBRD330T4G        |                   | 2,500 Tape & Reel |
| SBRD8330T4G*      |                   | 2,500 Tape & Reel |
| SBRD8330T4G-VF01* |                   | 2,500 Tape & Reel |
| MBRD340G          |                   | 75 Units / Rail   |
| SBRD8340G*        |                   | 75 Units / Rail   |
| SBRD8340G-VF01*   |                   | 75 Units / Rail   |
| MBRD340RLG        |                   | 1,800 Tape & Reel |
| MBRD340T4G        |                   | 2,500 Tape & Reel |
| SBRD8340T4G*      |                   | 2,500 Tape & Reel |
| SBRD8340T4G-VF01* |                   | 2,500 Tape & Reel |
| MBRD350G          |                   | 75 Units / Rail   |
| SBRD8350G*        |                   | 75 Units / Rail   |
| SBRD8350G-VF01*   |                   | 75 Units / Rail   |
| MBRD350RLG        |                   | 1,800 Tape & Reel |
| SBRD8350RLG*      |                   | 1,800 Tape & Reel |
| SBRD8350RLG-VF01* |                   | 1,800 Tape & Reel |
| MBRD350T4G        |                   | 2,500 Tape & Reel |
| SBRD8350T4G*      |                   | 2,500 Tape & Reel |
| SBRD8350T4G-VF01* |                   | 2,500 Tape & Reel |
| MBRD360G          |                   | 75 Units / Rail   |
| SBRD8360G*        |                   | 75 Units / Rail   |
| SBRD8360G-VF01*   |                   | 75 Units / Rail   |
| MBRD360RLG        |                   | 1,800 Tape & Reel |
| SBRD8360RLG*      |                   | 1,800 Tape & Reel |
| SBRD8360RLG-VF01* |                   | 1,800 Tape & Reel |
| MBRD360T4G        |                   | 2,500 Tape & Reel |
| NRVBD360VT4G*     |                   | 2,500 Tape & Reel |
| SBRD8360T4G*      |                   | 2,500 Tape & Reel |

†For information on tape and reel specifications, including part orientation and tape sizes, please refer to our Tape and Reel Packaging Specifications Brochure, BRD8011/D.

\*NRVBD and SBRD Prefixes for Automotive and Other Applications Requiring Unique Site and Control Change Requirements; AEC-Q101 Qualified and PPAP Capable.

TYPICAL CHARACTERISTICS

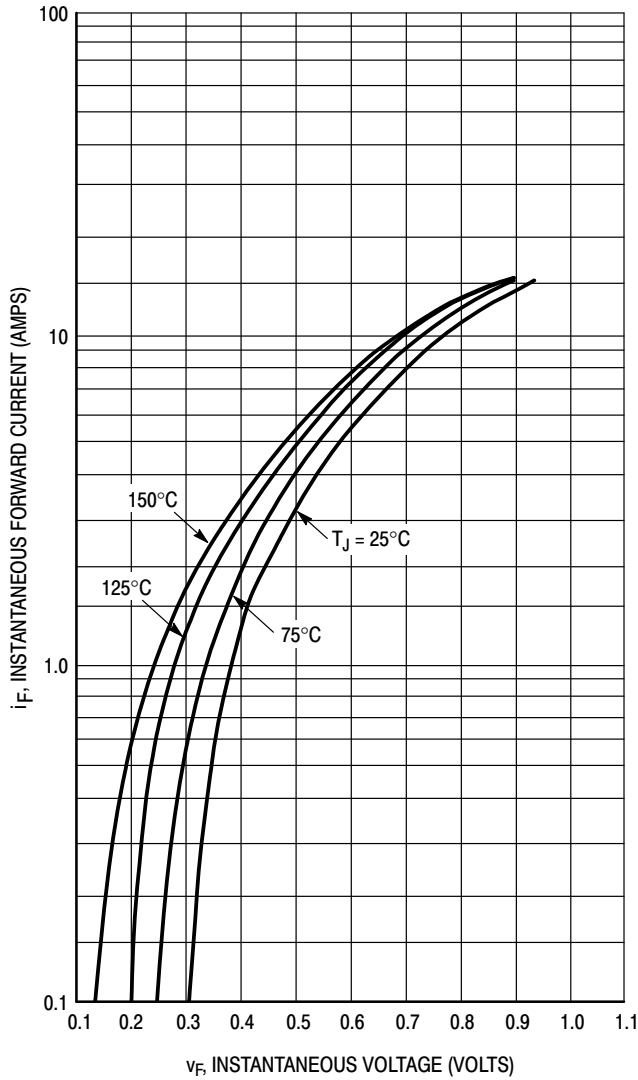
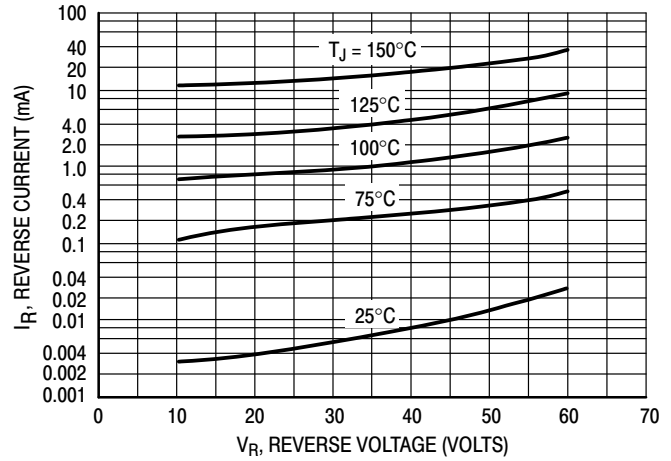

Figure 1. Typical Forward Voltage



\*The curves shown are typical for the highest voltage device in the voltage grouping. Typical reverse current for lower voltage selections can be estimated from these curves if  $V_R$  is sufficient below rated  $V_R$ .

Figure 2. Typical Reverse Current

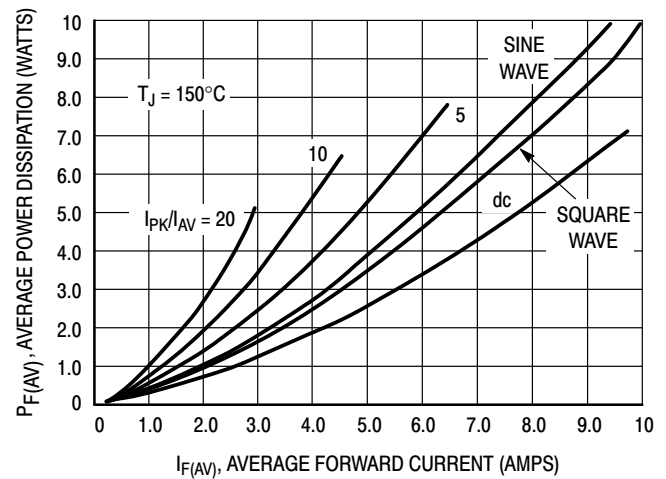

Figure 3. Average Power Dissipation

TYPICAL CHARACTERISTICS

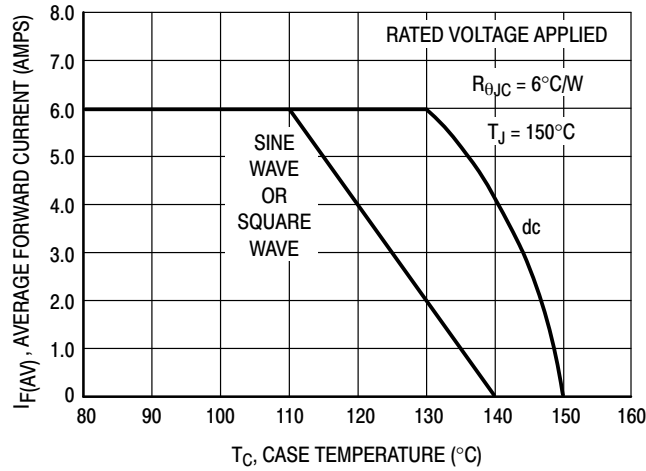

Figure 4. Current Derating, Case

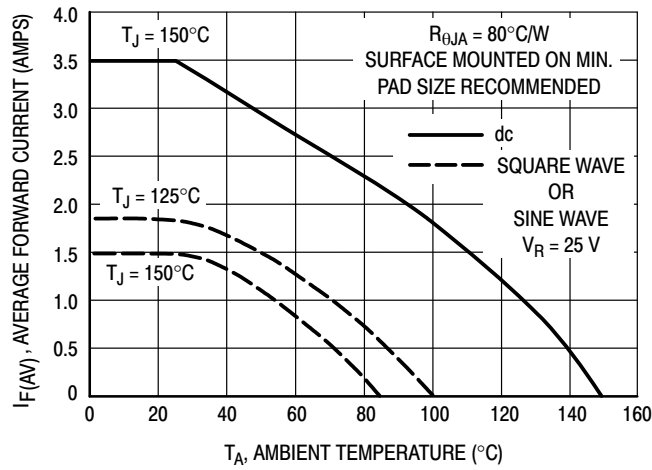

Figure 5. Current Derating, Ambient

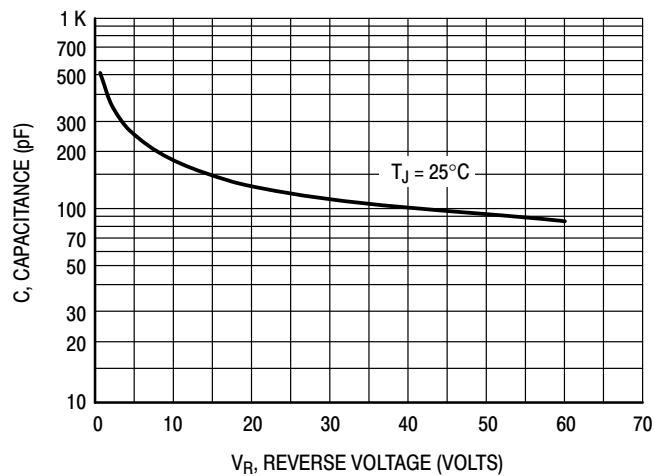
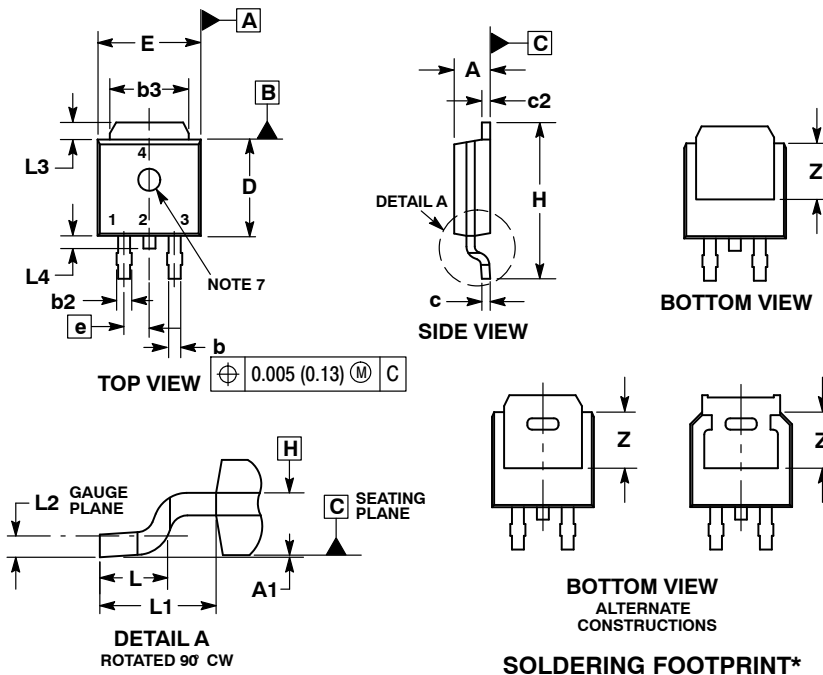

Figure 6. Typical Capacitance

# MBRD320G, MBRD330G, MBRD340G, MBRD350G, MBRD360G

## PACKAGE DIMENSIONS

### DPAK (SINGLE GAUGE) CASE 369C ISSUE F



#### NOTES:

1. DIMENSIONING AND TOLERANCING PER ASME Y14.5M, 1994.
2. CONTROLLING DIMENSION: INCHES.
3. THERMAL PAD CONTOUR OPTIONAL WITHIN DIMENSIONS b3, L3 and Z.
4. DIMENSIONS D AND E DO NOT INCLUDE MOLD FLASH, PROTRUSIONS, OR BURRS. MOLD FLASH, PROTRUSIONS, OR GATE BURRS SHALL NOT EXCEED 0.006 INCHES PER SIDE.
5. DIMENSIONS D AND E ARE DETERMINED AT THE OUTERMOST EXTREMES OF THE PLASTIC BODY.
6. DATUMS A AND B ARE DETERMINED AT DATUM PLANE H.
7. OPTIONAL MOLD FEATURE.

| DIM | INCHES    |       | MILLIMETERS |       |
|-----|-----------|-------|-------------|-------|
|     | MIN       | MAX   | MIN         | MAX   |
| A   | 0.086     | 0.094 | 2.18        | 2.38  |
| A1  | 0.000     | 0.005 | 0.00        | 0.13  |
| b   | 0.025     | 0.035 | 0.63        | 0.89  |
| b2  | 0.028     | 0.045 | 0.72        | 1.14  |
| b3  | 0.180     | 0.215 | 4.57        | 5.46  |
| c   | 0.018     | 0.024 | 0.46        | 0.61  |
| c2  | 0.018     | 0.024 | 0.46        | 0.61  |
| D   | 0.235     | 0.245 | 5.97        | 6.22  |
| E   | 0.250     | 0.265 | 6.35        | 6.73  |
| e   | 0.090 BSC |       | 2.29 BSC    |       |
| H   | 0.370     | 0.410 | 9.40        | 10.41 |
| L   | 0.055     | 0.070 | 1.40        | 1.78  |
| L1  | 0.114 REF |       | 2.90 REF    |       |
| L2  | 0.020 BSC |       | 0.51 BSC    |       |
| L3  | 0.035     | 0.050 | 0.89        | 1.27  |
| L4  | ---       | 0.040 | ---         | 1.01  |
| Z   | 0.155     | ---   | 3.93        | ---   |

#### SOLDERING FOOTPRINT\*

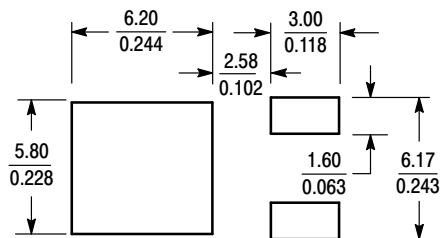

SCALE 3:1  $\left(\frac{\text{mm}}{\text{inches}}\right)$

\*For additional information on our Pb-Free strategy and soldering details, please download the ON Semiconductor Soldering and Mounting Techniques Reference Manual, SOLDERRM/D.

ON Semiconductor and are trademarks of Semiconductor Components Industries, LLC dba ON Semiconductor or its subsidiaries in the United States and/or other countries. ON Semiconductor owns the rights to a number of patents, trademarks, copyrights, trade secrets, and other intellectual property. A listing of ON Semiconductor's product/patent coverage may be accessed at [www.onsemi.com/site/pdf/Patent-Marking.pdf](http://www.onsemi.com/site/pdf/Patent-Marking.pdf). ON Semiconductor reserves the right to make changes without further notice to any products herein. ON Semiconductor makes no warranty, representation or guarantee regarding the suitability of its products for any particular purpose, nor does ON Semiconductor assume any liability arising out of the application or use of any product or circuit, and specifically disclaims any and all liability, including without limitation special, consequential or incidental damages. Buyer is responsible for its products and applications using ON Semiconductor products, including compliance with all laws, regulations and safety requirements or standards, regardless of any support or applications information provided by ON Semiconductor. "Typical" parameters which may be provided in ON Semiconductor data sheets and/or specifications can and do vary in different applications and actual performance may vary over time. All operating parameters, including "Typicals" must be validated for each customer application by customer's technical experts. ON Semiconductor does not convey any license under its patent rights nor the rights of others. ON Semiconductor products are not designed, intended, or authorized for use as a critical component in life support systems or any FDA Class 3 medical devices or medical devices with a same or similar classification in a foreign jurisdiction or any devices intended for implantation in the human body. Should Buyer purchase or use ON Semiconductor products for any such unintended or unauthorized application, Buyer shall indemnify and hold ON Semiconductor and its officers, employees, subsidiaries, affiliates, and distributors harmless against all claims, costs, damages, and expenses, and reasonable attorney fees arising out of, directly or indirectly, any claim of personal injury or death associated with such unintended or unauthorized use, even if such claim alleges that ON Semiconductor was negligent regarding the design or manufacture of the part. ON Semiconductor is an Equal Opportunity/Affirmative Action Employer. This literature is subject to all applicable copyright laws and is not for resale in any manner.

#### PUBLICATION ORDERING INFORMATION

##### LITERATURE FULFILLMENT:

Literature Distribution Center for ON Semiconductor  
19521 E. 32nd Pkwy, Aurora, Colorado 80011 USA  
Phone: 303-675-2175 or 800-344-3860 Toll Free USA/Canada  
Fax: 303-675-2176 or 800-344-3867 Toll Free USA/Canada  
Email: [orderlit@onsemi.com](mailto:orderlit@onsemi.com)

N. American Technical Support: 800-282-9855 Toll Free  
USA/Canada  
Europe, Middle East and Africa Technical Support:  
Phone: 421 33 790 2910  
Japan Customer Focus Center  
Phone: 81-3-5817-1050

ON Semiconductor Website: [www.onsemi.com](http://www.onsemi.com)

Order Literature: <http://www.onsemi.com/orderlit>

For additional information, please contact your local Sales Representative



Компания «ЭлектроПласт» предлагает заключение долгосрочных отношений при поставках импортных электронных компонентов на взаимовыгодных условиях!

Наши преимущества:

- Оперативные поставки широкого спектра электронных компонентов отечественного и импортного производства напрямую от производителей и с крупнейших мировых складов;
- Поставка более 17-ти миллионов наименований электронных компонентов;
- Поставка сложных, дефицитных, либо снятых с производства позиций;
- Оперативные сроки поставки под заказ (от 5 рабочих дней);
- Экспресс доставка в любую точку России;
- Техническая поддержка проекта, помощь в подборе аналогов, поставка прототипов;
- Система менеджмента качества сертифицирована по Международному стандарту ISO 9001;
- Лицензия ФСБ на осуществление работ с использованием сведений, составляющих государственную тайну;
- Поставка специализированных компонентов (Xilinx, Altera, Analog Devices, Intersil, Interpoint, Microsemi, Aeroflex, Peregrine, Syfer, Eurofarad, Texas Instrument, Miteq, Cobham, E2V, MA-COM, Hittite, Mini-Circuits, General Dynamics и др.);

Помимо этого, одним из направлений компании «ЭлектроПласт» является направление «Источники питания». Мы предлагаем Вам помощь Конструкторского отдела:

- Подбор оптимального решения, техническое обоснование при выборе компонента;
- Подбор аналогов;
- Консультации по применению компонента;
- Поставка образцов и прототипов;
- Техническая поддержка проекта;
- Защита от снятия компонента с производства.



#### Как с нами связаться

**Телефон:** 8 (812) 309 58 32 (многоканальный)

**Факс:** 8 (812) 320-02-42

**Электронная почта:** [org@eplast1.ru](mailto:org@eplast1.ru)

**Адрес:** 198099, г. Санкт-Петербург, ул. Калинина, дом 2, корпус 4, литера А.