

Low Noise 150mA LDO Regulator for High Temperature Applications

NO.EA-336-150821

OUTLINE

The RP130x is a CMOS-based positive voltage regulator IC with high ripple rejection, low dropout voltage, high output voltage accuracy and extremely low supply current. The RP130x consists of a voltage reference unit, an error amplifier, a resistor network for voltage setting, a short current limit circuit, and a chip enable circuit.

The RP130x has low supply current characteristics in the CMOS process. In addition, the RP130x can supply a low dropout voltage, which becomes the smallest difference between the input voltage and output voltage by having a low on-resistance and also can achieve the battery's long life by a chip enable function.

When compared with the conventional products of high-speed type, the RP130x achieves low consumption current of 38 μ A (Typ.) while improving the input transient response, the load transient response, and the ripple rejection.

The RP130x supports two package types: DFN(PLP)1010-4 and SOT-23-5. By the adoption of the ultra-compact DFN(PLP)1010-4, the RP130x can achieve a higher density mounting than ever.

FEATURES

- Input Voltage Range (Max. Rating)..... 1.7V to 6.5V (7.0V)
- Operating Temperature Range-40°C to 105°C (※)
- Supply Current..... Typ. 38 μ A
- Supply Current (Standby Mode)..... Typ. 0.1 μ A
- Ripple Rejection..... Typ. 80dB (f = 1kHz)
- Output Voltage Range 1.2V, 1.5V, 1.8V, 2.5V, 2.8V, 3.0V, 3.3V, 3.4V, 3.6V, and 5.0V
Contact Ricoh sales representatives for other voltages.
- Output Voltage Accuracy..... $\pm 1.0\%$ ($V_{SET} > 2.0V$, $T_a = 25^\circ C$)
- Temperature-Drift Coefficient of Output Voltage.... Typ. ± 20 ppm/ $^\circ C$
- Dropout Voltage Typ. 0.32V ($I_{OUT} = 150mA$, $V_{SET} = 2.8V$)
- Line Regulation..... Typ. 0.02%/V
- Packages DFN(PLP)1010-4, SOT-23-5
- Built-in Fold Back Protection Circuit..... Typ. 40mA
- Recommended Ceramic Capacitors 0.47 μ F or more
- Output Noise Voltage Typ. $20 \times V_{SET} \mu V_{rms}$
(BW = 10Hz to 100kHz, $I_{OUT} = 30mA$)

※ This product is usable for the high-temperature applications since have passed a test at the high temperature. In addition, this product has a high-reliability since having passed Ricoh's rigorous quality standards. To distinguish from the consumer products, "-Yx" is added at the end of the product name.

APPLICATIONS

- Industrial equipments such as FAs and smart meters
- Equipments used under high-temperature conditions
- Equipments accompanied by self-heating

BLOCK DIAGRAMS



SELECTION GUIDE

The output voltage, chip-enable polarity, auto-discharge function, and package type for this device can be selected at the user's request.

Product Name	Package	Quantity per Reel	Pb Free	Halogen Free
RP130Kxx1*-TR-Y	DFN(PLP)1010-4	10,000pcs	Yes	Yes
RP130Nxx1*-TR-YE	SOT-23-5	3,000pcs	Yes	Yes

xx : Specify the set output voltage (V_{SET})
 1.2 V (12) / 1.5 V (15) / 1.8 V (18) / 2.5 V (25) / 2.8 V (28) / 3.0 V (30) / 3.3 V (33) / 3.4 V (34) /
 3.6 V (36) / 5.0 V (50)
 Note: Contact Ricoh sales representatives for other voltages.

* : Specify the desired functions for chip-enable polarity and auto-discharge
 B: "H" active / No auto-discharge function
 D: "H" active / Auto-discharge function

Auto-Discharge function quickly lowers the output voltage to 0 V by releasing the electrical charge in the external capacitor when the chip enable signal is switched from the active mode to the standby mode.

PIN DESCRIPTION

• DFN(PLP)1010-4

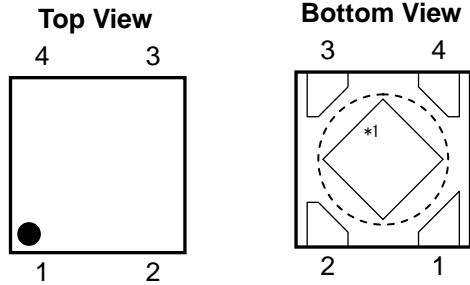

• SOT-23-5

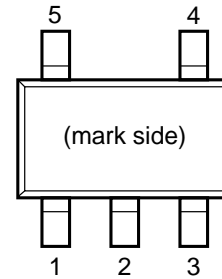

DFN(PLP)1010-4

Pin No.	Symbol	Description
1	V_{OUT}	Output Pin
2	GND	Ground Pin
3	CE	Chip Enable Pin ("H" Active)
4	V_{DD}	Input Pin

*1 The tab on the bottom of the package enhances thermal performance and is electrically connected to GND (substrate level). It is recommended that the tab be connected to the ground plane on the board, or otherwise be left floating.

SOT-23-5

Pin No.	Symbol	Description
1	V_{DD}	Output Pin
2	GND	Ground Pin
3	CE	Chip Enable Pin ("H" Active)
4	NC	No Connection
5	V_{OUT}	Output Pin

ABSOLUTE MAXIMUM RATINGS

Symbol	Item		Rating	Unit
V_{IN}	Input Voltage		-0.3 to 7.0	V
V_{CE}	Input Voltage (CE Pin)		-0.3 to 7.0	V
V_{OUT}	Output Voltage		-0.3 to $V_{IN}+0.3$	V
I_{OUT}	Output Current		200	mA
P_D	Power Dissipation (DFN(PLP)1010-4) *1	Standard Land Pattern	400	mW
	Power Dissipation (SOT-23-5) *1	Standard Land Pattern	420	
T_j	Junction Temperature		-40 to 125	°C
T_{stg}	Strong Temperature Range		-55 to 125	°C

*1 Refer to *PACKAGE INFORMATION* for detailed information.

ABSOLUTE MAXIMUM RATINGS

Electronic and mechanical stress momentarily exceeded absolute maximum ratings may cause the permanent damages and may degrade the life time and safety for both device and system using the device in the field.

The functional operation at or over these absolute maximum rating is not assured.

RECOMMENDED OPERATING RATINGS

Symbol	Item	Rating	Unit
V_{IN}	Input Voltage	1.7 to 6.5	V
T_a	Operating Temperature Range	-40 to 105	°C

RECOMMENDED OPERATING RATINGS

All of electronic equipment should be designed that the mounted semiconductor devices operate within the recommended operating ratings. The semiconductor devices cannot operate normally over the recommended operating ratings, even if when they are used over such ratings by momentary electronic noise or surge. And the semiconductor devices may receive serious damage when they continue to operate over the recommended operating ratings.

ELECTRICAL CHARACTERISTICS

$V_{IN} = V_{SET} + 1.0V$ ($V_{SET} > 1.5V$), $V_{IN} = 2.5V$ ($V_{SET} \leq 1.5V$), $I_{OUT} = 1mA$, $C_{IN} = C_{OUT} = 0.47\mu F$, unless otherwise noted.
 The specifications surrounded by are guaranteed by design engineering at $-40^{\circ}C \leq T_a \leq 105^{\circ}C$.

RP130xxx1B/D

($T_a = 25^{\circ}C$)

Symbol	Item	Conditions	Min.	Typ.	Max.	Unit	
V_{OUT}	Output Voltage	$T_a = 25^{\circ}C$	$V_{SET} > 2.0V$	$\times 0.99$		$\times 1.01$	V
			$V_{SET} \leq 2.0V$	-20		20	mV
		$-40^{\circ}C \leq T_a \leq 105^{\circ}C$	$V_{SET} > 2.0V$	×0.985		×1.015	V
			$V_{SET} \leq 2.0V$	-30		30	mV
I_{OUT}	Output Current		150			mA	
$\frac{\Delta V_{OUT}}{\Delta I_{OUT}}$	Load Regulation	$1mA \leq I_{OUT} \leq 150mA$		10	30	mV	
V_{DIF}	Dropout Voltage	$I_{OUT} = 150mA$	$1.2V \leq V_{SET} < 1.5V$		0.67	1.03	V
			$1.5V \leq V_{SET} < 1.7V$		0.54	0.84	
			$1.7V \leq V_{SET} < 2.0V$		0.46	0.75	
			$2.0V \leq V_{SET} < 2.5V$		0.41	0.63	
			$2.5V \leq V_{SET} < 4.0V$		0.32	0.51	
			$V_{SET} = 5V$		0.24	0.31	
I_{SS}	Supply Current	$I_{OUT} = 0mA$		38	58	μA	
$I_{standby}$	Supply Current (at Standby)	$V_{CE} = 0$		0.1	1.0	μA	
$\frac{\Delta V_{OUT}}{\Delta V_{IN}}$	Line Regulation	$V_{SET} + 0.5V \leq V_{IN} \leq 6.5V$		0.02	0.10	%/V	
I_{SC}	Short Current Limit	$V_{OUT} = 0V$		40		mA	
I_{PD}	CE Pull-down Current			0.4		μA	
V_{CEH}	CE Input Voltage "H"		1.0			V	
V_{CEL}	CE Input Voltage "L"				0.36	V	
R_{LOW}	Nch ON Resistance for Auto Discharge (D Version Only)	$V_{IN} = 4.0V, V_{CE} = 0V$		30		Ω	

All test items listed under Electrical Characteristics are done under the pulse load condition ($T_j \approx T_a = 25^{\circ}C$)

RP130x-YNO.EA-336-150821

Product-specific Electrical CharacteristicsThe specifications surrounded by are guaranteed by design engineering at $-40^{\circ}\text{C} \leq T_a \leq 105^{\circ}\text{C}$.

(Ta = 25°C)

Product Name	V _{OUT} [V] (Ta = 25°C)			V _{OUT} [V] (Ta = -40 ~ 105°C)			V _{DIF} [V]	
	Min.	Typ.	Max.	Min.	Typ.	Max.	Typ.	Max.
RP130x121x	1.180	1.200	1.220	1.170	1.200	1.230	0.67	1.03
RP130x151x	1.480	1.500	1.520	1.470	1.500	1.530	0.54	0.84
RP130x181x	1.780	1.800	1.820	1.770	1.800	1.830	0.46	0.75
RP130x251x	2.475	2.500	2.525	2.463	2.500	2.538	0.32	0.51
RP130x281x	2.772	2.800	2.828	2.758	2.800	2.842		
RP130x301x	2.970	3.000	3.030	2.955	3.000	3.045		
RP130x331x	3.267	3.300	3.333	3.251	3.300	3.350		
RP130x341x	3.366	3.400	3.434	3.349	3.400	3.451		
RP130x361x	3.564	3.600	3.636	3.546	3.600	3.654	0.24	0.31
RP130x501x	4.950	5.000	5.050	4.925	5.000	5.075		

TYPICAL APPLICATION



External Components :

Symbol	Description
C2	0.47 μ F (Ceramic)

TECHNICAL NOTES

Phase Compensation

In the ICs, phase compensation is made for securing stable operation even if the load current is varied. For this purpose, use a capacitor C2 with 0.47 μ F or more.

If a tantalum capacitor is used, and its ESR (Equivalent Series Resistance) of C2 is large, the loop oscillation may result. Because of this, select C2 carefully considering its frequency characteristics.

PCB Layout

Make V_{DD} and GND lines sufficient. If their impedance is too high, noise pickup or unstable operation may result. Connect 0.47 μ F or more of the capacitor C1 between the V_{DD} and GND, and as close as possible to the pins.

In addition, connect the capacitor C2 between V_{OUT} and GND, and as close as possible to the pins.

TYPICAL APPLICATION FOR IC CHIP BREAKDOWN PREVENTION

When a sudden surge of electrical current travels along the V_{OUT} pin and GND due to a short-circuit, electrical resonance of a circuit involving an output capacitor (C2) and a short circuit inductor generates a negative voltage and may damage the device or the load devices. Connecting a schottky diode (D1) between the V_{OUT} pin and GND has the effect of preventing damage to them.

PACKAGE INFORMATION

Power Dissipation (DFN(PLP)1010-4)

Power Dissipation (P_D) depends on conditions of mounting on board. This specification is based on the measurement at the condition below:

Measurement Conditions

	Standard Test Land Pattern
Environment	Mounting on Board (Wind velocity=0m/s)
Board Material	Glass cloth epoxy plastic (Double sided)
Board Dimensions	40mm x 40mm x 1.6mm
Copper Ratio	Top side: Approx. 50%, Back side: Approx. 50%
Through-holes	ϕ 0.54mm x 24pcs

Measurement Result

($T_a=25^\circ\text{C}$, $T_{j\text{max}}=125^\circ\text{C}$)

	Standard Test Land Pattern
Power Dissipation	400mW
Thermal Resistance	$\theta_{ja} = (125-25^\circ\text{C})/0.4\text{W} = 250^\circ\text{C/W}$
	$\theta_{jc} = 67^\circ\text{C/W}$

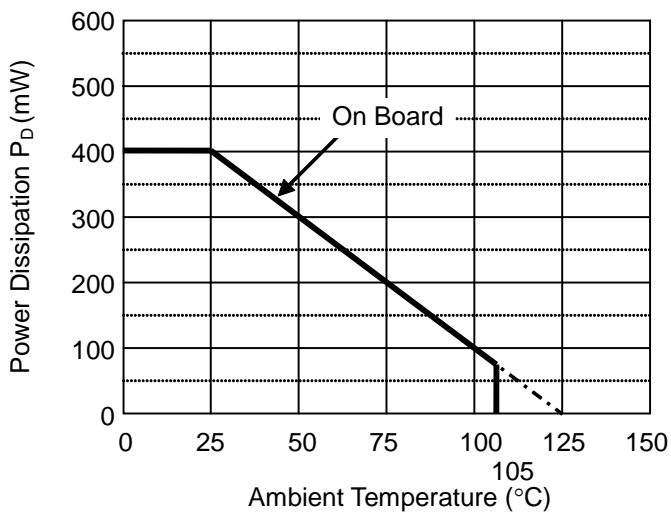

Power Dissipation



Measurement Board Pattern

 IC Mount Area (Unit : mm)

RP130x-Y

NO.EA-336-150821

Package Dimensions (DFN(PLP)1010-4)

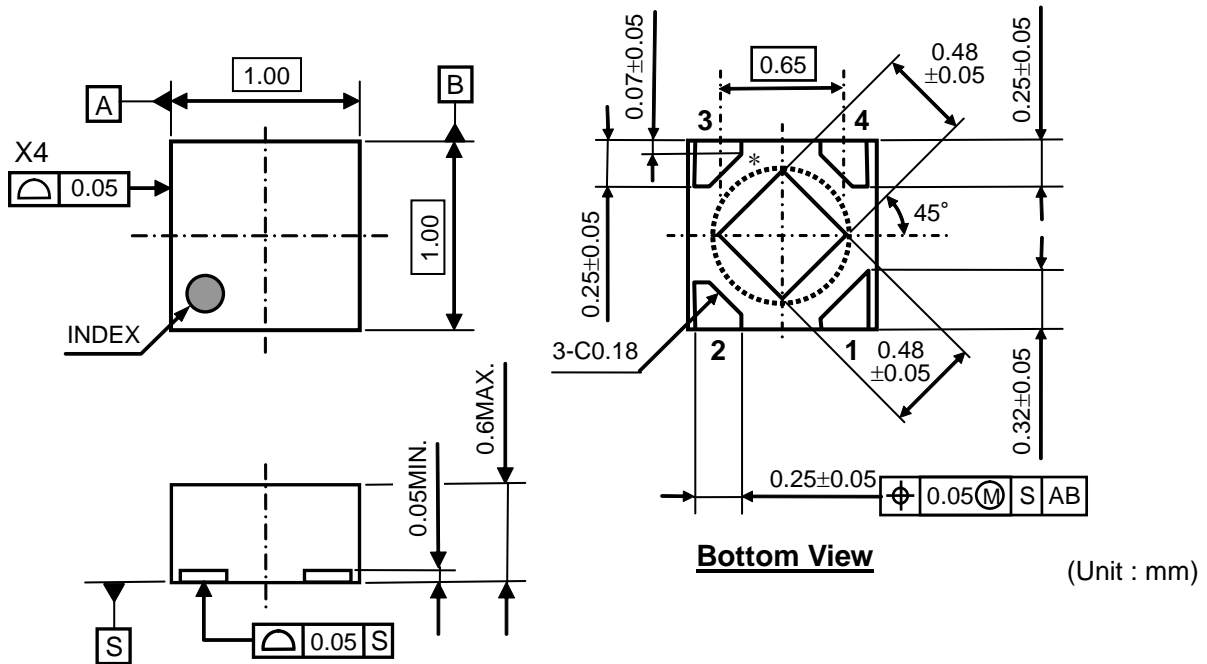

*) The tab on the bottom of the package enhances thermal performance and is electrically connected to GND (substrate level). It is recommended that the tab be connected to the ground plane on the board, or otherwise be left floating.

DFN(PLP)1010-4 Package Dimensions

Mark Specifications (DFN(PLP)1010-4)

①②: Product Code ... Refer to “RP130K Mark Specification Table”

③④: Lot Number ...Alphanumeric Serial Number

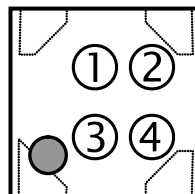

DFN(PLP)1010-4 Mark Specifications

RP130K Mark Specification Table (DFN(PLP)1010-4)**RP130Kxx1B**

Product Name	① ②	V_{SET}
RP130K121B	T A	1.2V
RP130K151B	T D	1.5V
RP130K181B	T G	1.8V
RP130K251B	T Q	2.5V
RP130K281B	T T	2.8V
RP130K301B	T W	3.0V
RP130K331B	T Z	3.3V
RP130K341B	U A	3.4V
RP130K361B	U C	3.6V
RP130K501B	U S	5.0V

RP130Kxx1D

Product	① ②	V_{SET}
RP130K121D	V A	1.2V
RP130K151D	V D	1.5V
RP130K181D	V G	1.8V
RP130K251D	V Q	2.5V
RP130K281D	V T	2.8V
RP130K301D	V W	3.0V
RP130K331D	V Z	3.3V
RP130K341D	W A	3.4V
RP130K361D	W C	3.6V
RP130K501D	W S	5.0V

Power Dissipation (SOT-23-5)

Power Dissipation (P_D), which indicates the P_D of SOT-23-6 package as a substitute, depends on conditions of mounting on board. This specification is based on the measurement at the condition below:

Measurement Conditions

	Standard Test Land Pattern
Environment	Mounting on Board (Wind velocity=0m/s)
Board Material	Glass cloth epoxy plastic (Double sided)
Board Dimensions	40mm x 40mm x 1.6mm
Copper Ratio	Top side: Approx. 50%, Back side: Approx. 50%
Through-holes	ϕ 0.5mm x 44pcs

Measurement Result

($T_a=25^\circ\text{C}$, $T_{j\text{max}}=125^\circ\text{C}$)

	Standard Land Pattern	Free Air
Power Dissipation	420mW	250mW
Thermal Resistance	$\theta_{ja} = (125-25^\circ\text{C})/0.42\text{W} = 238^\circ\text{C/W}$	400 $^\circ\text{C/W}$



Measurement Board Pattern

IC Mount Area (Unit: mm)

Power Dissipation

Package Dimensions (SOT-23-5)

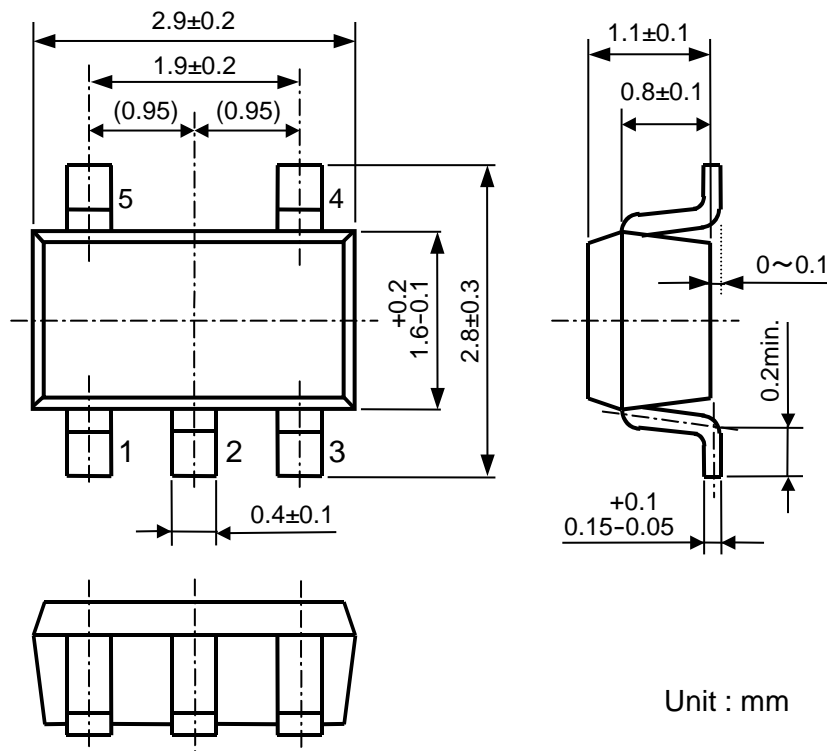

Unit : mm

SOT-23-5 Package Dimensions

Mark Specifications (SOT-23-5)

①②③: Product Code ... Refer to “RP130N Mark Specification Table”

④⑤: Lot Number ...Alphanumeric Serial Number

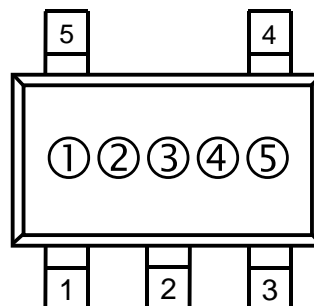

SOT-23-5 Mark Specifications

RP130x-YNO.EA-336-150821

RP130N Mark Specification Table (SOT-23-5)**RP130Nxx1B**

Product Name	①②③	V_{SET}
RP130N121B	H 1 A	1.2 V
RP130N151B	H 1 D	1.5 V
RP130N181B	H 1 G	1.8 V
RP130N251B	H 1 Q	2.5 V
RP130N281B	H 1 T	2.8 V
RP130N301B	H 1 W	3.0 V
RP130N331B	H 1 Z	3.3 V
RP130N341B	J 1 A	3.4 V
RP130N361B	J 1 C	3.6 V
RP130N501B	J 1 S	5.0 V

RP130Nxx1D

Product Name	①②③	V_{SET}
RP130N121D	H 2 A	1.2 V
RP130N151D	H 2 D	1.5 V
RP130N181D	H 2 G	1.8 V
RP130N251D	H 2 Q	2.5 V
RP130N281D	H 2 T	2.8 V
RP130N301D	H 2 W	3.0 V
RP130N331D	H 2 Z	3.3 V
RP130N341D	J 2 A	3.4 V
RP130N361D	J 2 C	3.6 V
RP130N501D	J 2 S	5.0 V

TEST CIRCUITS



Standard Test Circuit



Supply Current Test Circuit



Ripple Rejection, Line Transient Response Test Circuit



Load Transient Response Test Circuit

TYPICAL CHARACTERISTICS

Note: Typical Characteristics are intended to be used as reference data; they are not guaranteed.

1) Output Voltage vs. Output Current ($C1 = C2 = 0.47\mu F$, $Ta = 25^\circ C$)



2) Output Voltage vs. Input Voltage ($C1 = C2 = 0.47\mu F$, $Ta = 25^\circ C$)





3) Supply Current vs. Input Voltage ($C1 = C2 = 0.47\mu\text{F}$, $T_a = 25^\circ\text{C}$)

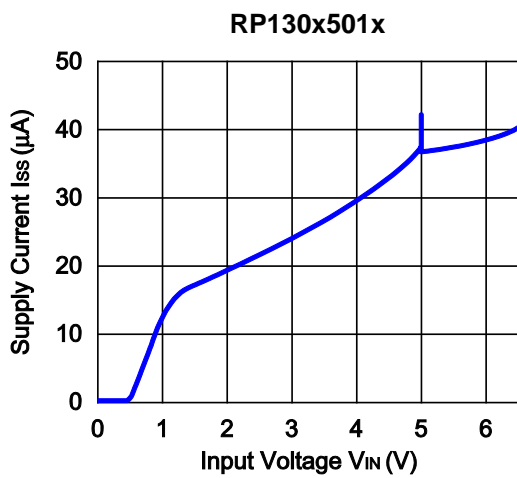
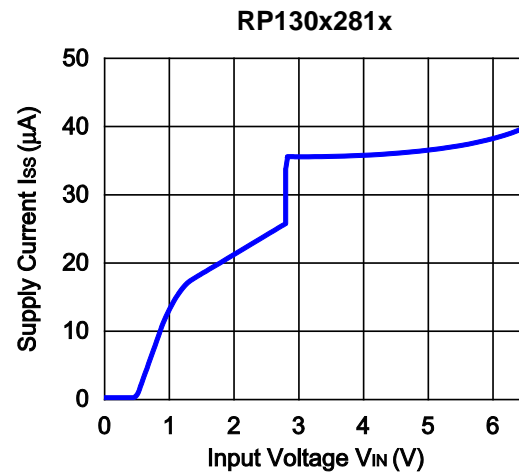
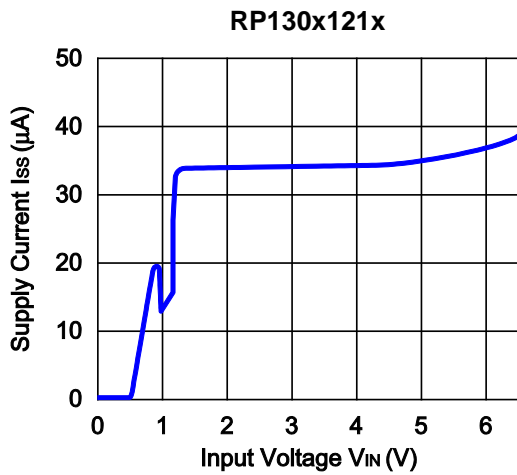

RP130x-Y

NO.EA-336-150821

4) Output Voltage vs. Temperature ($I_{OUT} = 1\text{mA}$, $C1 = C2 = 0.47\mu\text{F}$)

RP130x121x



RP130x281x

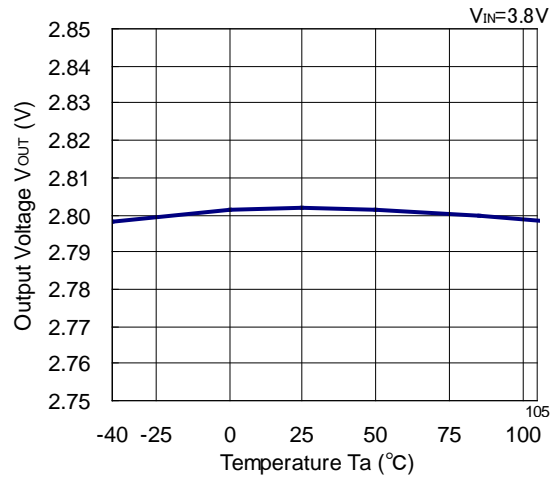

RP130x501x



5) Supply Current vs. Temperature ($I_{OUT} = 0\text{mA}$, $C1 = C2 = 0.47\mu\text{F}$)

RP130x121x



RP130x281x

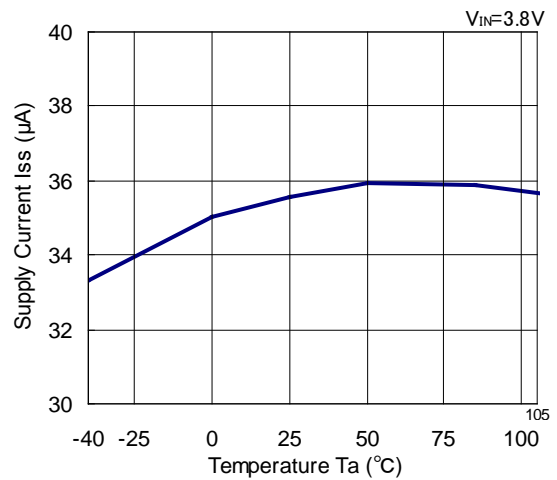

RP130x501x



6) Dropout Voltage vs. Output Current ($C1 = C2 = 0.47\mu F$)

RP130x121x

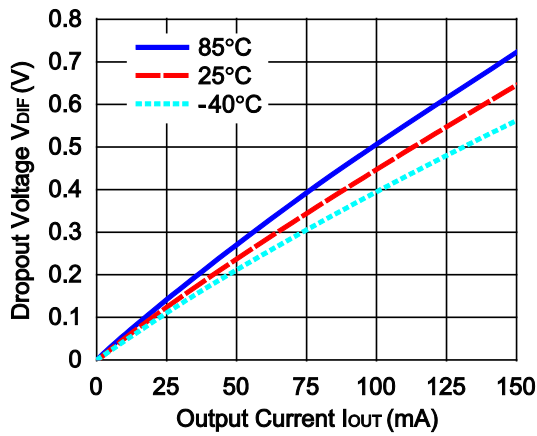

RP130x281x



RP130x501x

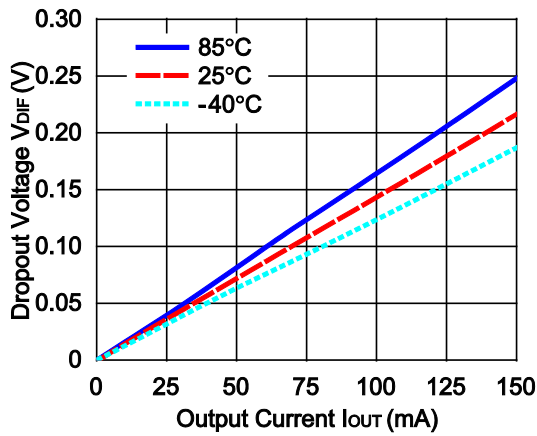

7) Dropout Voltage vs. Set Output Voltage (C1 = C2 = 0.47μF)



8) Ripple Rejection vs. Input Bias Voltage (C1 = none, C2 = 0.47μF, Ripple = 0.2Vp-p, $T_a = 25^\circ C$)



9) Ripple Rejection vs. Frequency (C1 = none, C2 = 0.47μF, Ripple = 0.2Vp-p, $T_a = 25^\circ C$)





10) Input Transient Response ($I_{OUT} = 30mA$, $t_r = t_f = 5\mu s$, $C1 = \text{none}$, $C2 = 0.47\mu F$, $T_a = 25^\circ C$)



RP130x-Y

NO.EA-336-150821

11) Load Transient Response ($t_r = t_f = 0.5\mu s$, $C_1 = C_2 = 0.47\mu F$, $I_{OUT} = 50mA \leftrightarrow 100mA$, $T_a = 25^\circ C$)



12) Load Transient Response ($t_r = t_f = 0.5\mu s$, $C_1 = C_2 = 0.47\mu F$, $I_{OUT} = 1mA \leftrightarrow 150mA$, $T_a = 25^\circ C$)





13) Rise Time with CE Pin ($C1 = C2 = 0.47\mu F$, $T_a = 25^\circ C$)



RP130x281x

$I_{OUT}=30mA$



RP130x281x

$I_{OUT}=150mA$



RP130x501x

$I_{OUT}=1mA$



RP130x501x

$I_{OUT}=30mA$



RP130x501x

$I_{OUT}=150mA$



14) Fall Time with CE Pin in D-Version ($C1 = C2 = 0.47\mu\text{F}$, $T_a = 25^\circ\text{C}$)



RP130x501D

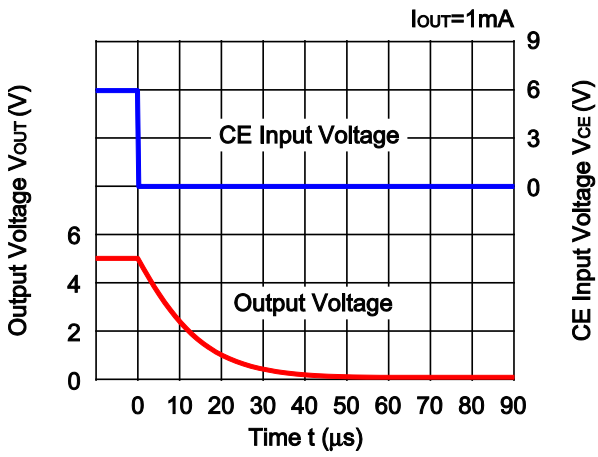

RP130x501D

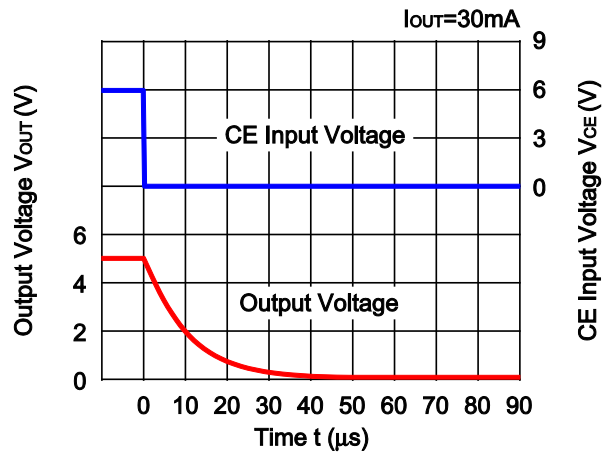

RP130x501D



15) Minimum Operating Voltage ($C1 = C2 = 0.47\mu F$)

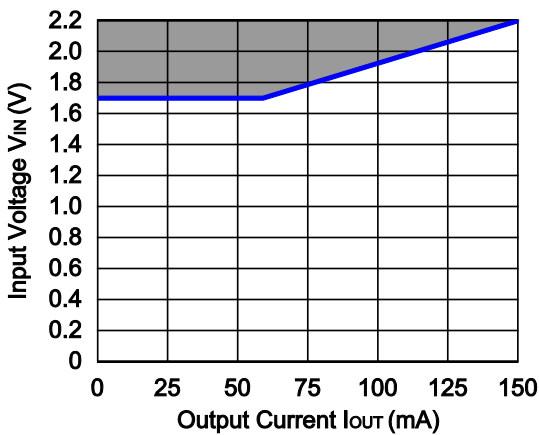

Hatched area is available for 1.2V output.

ESR vs. Output Current

The RP130x is recommended to use a ceramic type capacitor, but the RP130x can be used other capacitors of the lower ESR type. The relation between the output current (I_{OUT}) and the ESR of output capacitor is shown below.

Measurement conditions

Frequency Band: 10 Hz to 3 MHz

Measurement Temperature: -40°C to 85°C

Hatched area: Noise level is $40\ \mu\text{V}$ (average) or below

Ceramic Capacitor: C1 = Ceramic $0.47\ \mu\text{F}$, C2 = $0.47\ \mu\text{F}$





1. The products and the product specifications described in this document are subject to change or discontinuation of production without notice for reasons such as improvement. Therefore, before deciding to use the products, please refer to Ricoh sales representatives for the latest information thereon.
2. The materials in this document may not be copied or otherwise reproduced in whole or in part without prior written consent of Ricoh.
3. Please be sure to take any necessary formalities under relevant laws or regulations before exporting or otherwise taking out of your country the products or the technical information described herein.
4. The technical information described in this document shows typical characteristics of and example application circuits for the products. The release of such information is not to be construed as a warranty of or a grant of license under Ricoh's or any third party's intellectual property rights or any other rights.
5. The products listed in this document are intended and designed for use as general electronic components in standard applications (office equipment, telecommunication equipment, measuring instruments, consumer electronic products, amusement equipment etc.). Those customers intending to use a product in an application requiring extreme quality and reliability, for example, in a highly specific application where the failure or misoperation of the product could result in human injury or death (aircraft, spacevehicle, nuclear reactor control system, traffic control system, automotive and transportation equipment, combustion equipment, safety devices, life support system etc.) should first contact us.
6. We are making our continuous effort to improve the quality and reliability of our products, but semiconductor products are likely to fail with certain probability. In order to prevent any injury to persons or damages to property resulting from such failure, customers should be careful enough to incorporate safety measures in their design, such as redundancy feature, fire containment feature and fail-safe feature. We do not assume any liability or responsibility for any loss or damage arising from misuse or inappropriate use of the products.
7. Anti-radiation design is not implemented in the products described in this document.
8. Please contact Ricoh sales representatives should you have any questions or comments concerning the products or the technical information.



Ricoh is committed to reducing the environmental loading materials in electrical devices with a view to contributing to the protection of human health and the environment.

Ricoh has been providing RoHS compliant products since April 1, 2006 and Halogen-free products since April 1, 2012.

RICOH RICOH ELECTRONIC DEVICES CO., LTD.

<http://www.e-devices.ricoh.co.jp/en/>

Sales & Support Offices

RICOH ELECTRONIC DEVICES CO., LTD.

Higashi-Shinagawa Office (International Sales)
3-32-3, Higashi-Shinagawa, Shinagawa-ku, Tokyo 140-8655, Japan
Phone: +81-3-5479-2857 Fax: +81-3-5479-0502

RICOH EUROPE (NETHERLANDS) B.V.

Semiconductor Support Centre
Prof. W.H. Keesomlaan 1, 1183 DJ Amstelveen, The Netherlands
Phone: +31-20-5474-309

RICOH ELECTRONIC DEVICES KOREA CO., LTD.

3F, Haesung Bldg. 504, Teheran-ro, Gangnam-gu, Seoul, 135-725, Korea
Phone: +82-2-2135-5700 Fax: +82-2-2051-5713

RICOH ELECTRONIC DEVICES SHANGHAI CO., LTD.

Room 403, No.2 Building, No.690 Bilbo Road, Pu Dong New District, Shanghai 201203,
People's Republic of China
Phone: +86-21-5027-3200 Fax: +86-21-5027-3299

RICOH ELECTRONIC DEVICES CO., LTD.

Taipei office
Room 109, 10F-1, No.51, Hengyang Rd., Taipei City, Taiwan (R.O.C.)
Phone: +886-2-2313-1621/1622 Fax: +886-2-2313-1623

Mouser Electronics

Authorized Distributor

Click to View Pricing, Inventory, Delivery & Lifecycle Information:

[Ricoh Electronics:](#)

[RP130N331B-TR-YE](#)



Компания «ЭлектроПласт» предлагает заключение долгосрочных отношений при поставках импортных электронных компонентов на взаимовыгодных условиях!

Наши преимущества:

- Оперативные поставки широкого спектра электронных компонентов отечественного и импортного производства напрямую от производителей и с крупнейших мировых складов;
- Поставка более 17-ти миллионов наименований электронных компонентов;
- Поставка сложных, дефицитных, либо снятых с производства позиций;
- Оперативные сроки поставки под заказ (от 5 рабочих дней);
- Экспресс доставка в любую точку России;
- Техническая поддержка проекта, помощь в подборе аналогов, поставка прототипов;
- Система менеджмента качества сертифицирована по Международному стандарту ISO 9001;
- Лицензия ФСБ на осуществление работ с использованием сведений, составляющих государственную тайну;
- Поставка специализированных компонентов (Xilinx, Altera, Analog Devices, Intersil, Interpoint, Microsemi, Aeroflex, Peregrine, Syfer, Eurofarad, Texas Instrument, Miteq, Cobham, E2V, MA-COM, Hittite, Mini-Circuits, General Dynamics и др.);

Помимо этого, одним из направлений компании «ЭлектроПласт» является направление «Источники питания». Мы предлагаем Вам помощь Конструкторского отдела:

- Подбор оптимального решения, техническое обоснование при выборе компонента;
- Подбор аналогов;
- Консультации по применению компонента;
- Поставка образцов и прототипов;
- Техническая поддержка проекта;
- Защита от снятия компонента с производства.



Как с нами связаться

Телефон: 8 (812) 309 58 32 (многоканальный)

Факс: 8 (812) 320-02-42

Электронная почта: org@eplast1.ru

Адрес: 198099, г. Санкт-Петербург, ул. Калинина, дом 2, корпус 4, литера А.