

Click [here](#) for production status of specific part numbers.

## MAXM15465/MAXM15466/ MAXM15467

### General Description

The Himalaya series of voltage regulator ICs and power modules enable cooler, smaller, and simpler power-supply solutions. The MAXM15465/MAXM15466/MAXM15467 are a family of high-efficiency, synchronous step-down DC-DC modules with integrated controller, MOSFETs, compensation components, and inductor that operate over a wide input-voltage range. The modules operate from 4.5V to 42V input and deliver up to 300mA output current. The MAXM15465 and MAXM15466 are fixed 3.3V and 5V output modules respectively. The MAXM15467 is an adjustable output (0.9V to 6.3V) module. The modules significantly reduce design complexity, manufacturing risks, and offer a true plug and play power/supply solution, reducing time-to-market.

The MAXM15465/6/7 modules employ peak-current-mode control architecture. To reduce input inrush current, the modules offer a fixed 3.75ms soft-start time.

The MAXM15465/6/7 modules are available in a low profile, compact 10-pin, 2.6mm x 3mm x 1.5mm, uSLIC™ package.

### Applications

- Industrial Sensors and Encoders
- 4-20mA Current-Loop Powered Sensors
- LDO Replacement
- HVAC and Building Control
- Battery-Powered Equipment
- General Purpose Point-of-Load
- USB Type-C Powered loads

### Typical Application Circuit 2.5V

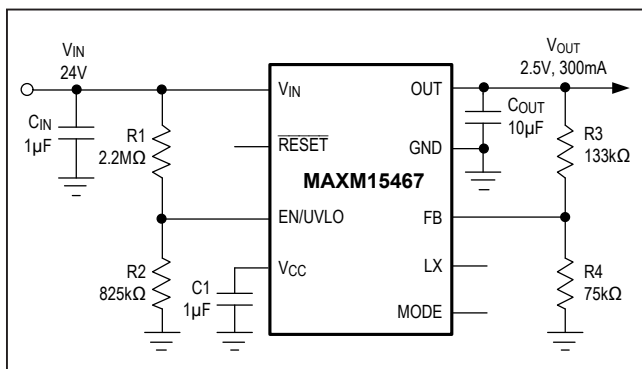

## 4.5V to 42V, 300mA Himalaya uSLIC Step-Down Power Module

### Benefits and Features

- Easy to Use
  - Wide 4.5V to 42V Input
  - Adjustable 0.9V to 6.3V Output
  - Fixed 3.3V and 5V Output (MAXM15465 and MAXM15466)
  - ±1.5% Feedback Accuracy
  - Up to 300mA Output-Current
  - Internally Compensated
  - All Ceramic Capacitors
- High Efficiency
  - Selectable PWM- or PFM-Mode of Operation
  - Shutdown Current as Low as 2.2μA (typ)
- Flexible Design
  - Internal Soft-Start and Prebias Startup
  - Open-Drain Power Good Output (RESET Pin)
  - Programmable EN/UVLO Threshold
- Robust Operation
  - Hiccup Overcurrent Protection
  - Overtemperature Protection
  - -40°C to +125°C Ambient Operating Temperature/  
-40°C to +150°C Junction Temperature
- Rugged
  - Complies with CISPR22(EN55022) Class B Conducted and Radiated Emissions
  - Passes Drop, Shock, and Vibration Standards: JESD22-B103, B104, B111

**Ordering Information** appears at end of data sheet.

uSLIC is a trademark of Maxim Integrated Products, Inc.

### Typical Application Circuit 5V

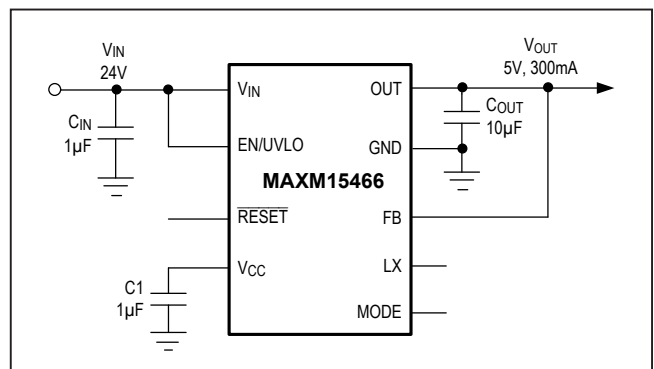

MAXM15465/MAXM15466/  
MAXM15467

4.5V to 42V, 300mA Himalaya uSLIC  
Step-Down Power Module

**Absolute Maximum Ratings**

V <sub>IN</sub> , EN/UVLO to GND.....	-0.3V to 48V	Junction Temperature (Note 1).....	+150°C
LX, OUT and GND.....	-0.3V to (V <sub>IN</sub> + 0.3V)	Storage Temperature Range.....	-55°C to +125°C
V <sub>CC</sub> , FB, RESET to GND.....	-0.3V to 6V	Lead temperature (soldering, 10s).....	+260°C
MODE to GND.....	-0.3V to (V <sub>CC</sub> + 0.3V)	Soldering Temperature (reflow).....	+260°C
Output Short-Circuit Duration.....	Continuous		

Stresses beyond those listed under "Absolute Maximum Ratings" may cause permanent damage to the device. These are stress ratings only, and functional operation of the device at these or any other conditions beyond those indicated in the operational sections of the specifications is not implied. Exposure to absolute maximum rating conditions for extended periods may affect device reliability.

**Package Information**

<b>PACKAGE TYPE: 10-PIN uSLIC</b>	
Package Code	M102A3+2
Outline Number	<a href="#">21-100094</a>
Land Pattern Number	<a href="#">90-100027</a>
<b>THERMAL RESISTANCE, FOUR-LAYER BOARD (Note 2)</b>	
Junction to Ambient (θ <sub>JA</sub> )	41.56 °C/W

For the latest package outline information and land patterns (footprints), go to [www.maximintegrated.com/packages](http://www.maximintegrated.com/packages). Note that a "+", "#", or "-" in the package code indicates RoHS status only. Package drawings may show a different suffix character, but the drawing pertains to the package regardless of RoHS status.

- Note 1:** Junction temperature greater than +125°C degrades operating lifetimes.
- Note 2:** Package thermal resistance is measured on an evaluation board with natural convection.

**Electrical Characteristics**

(V<sub>IN</sub> = V<sub>EN/UVLO</sub> = 24V, V<sub>GND</sub> = 0V, C<sub>VCC</sub> = 1µF, FB = 1V (MAXM15467), FB = 3.6V (MAXM15465) FB = 5.5V (MAXM15466), LX = MODE = RESET = OUT = unconnected; T<sub>A</sub> = -40°C to +125°C, unless otherwise noted. Typical values are at T<sub>A</sub> = +25°C. All voltages are referenced to GND, unless otherwise noted.) (Note 3)

PARAMETER	SYMBOL	CONDITIONS	MIN	TYP	MAX	UNITS
<b>INPUT SUPPLY (V<sub>IN</sub>)</b>						
Input-Voltage Range	V <sub>IN</sub>		4.5		42	V
Input-Shutdown Current	I <sub>IN-SH</sub>	V <sub>EN/UVLO</sub> = 0V, shutdown mode		2.2	4	µA
Input-Supply Current	I <sub>Q-PFM</sub>	MODE = unconnected, FB = 1.03 × V <sub>FB-REG</sub>		95	160	µA
	I <sub>Q-PWM</sub>	Normal switching mode, V <sub>IN</sub> = 24V, MODE=0		3.2		mA
<b>ENABLE/UVLO (EN/UVLO)</b>						
EN/UVLO Threshold	V <sub>ENR</sub>	V <sub>EN/UVLO</sub> rising	1.19	1.215	1.28	V
	V <sub>ENF</sub>	V <sub>EN/UVLO</sub> falling	1.06	1.09	1.16	
	V <sub>EN-TRUESD</sub>	V <sub>EN/UVLO</sub> falling, true shutdown		0.75		
EN/UVLO Input-Leakage Current	I <sub>EN/UVLO</sub>	T <sub>A</sub> = +25°C	-100		+100	nA
<b>LDO (V<sub>CC</sub>)</b>						
V <sub>CC</sub> Output-Voltage Range	V <sub>CC</sub>	6V < V <sub>IN</sub> < 42V, 0mA < I <sub>VCC</sub> < 10mA	4.75	5	5.25	V
V <sub>CC</sub> Current Limit	I <sub>VCC-MAX</sub>	V <sub>CC</sub> = 4.3V	13	30	50	mA

### Electrical Characteristics (continued)

( $V_{IN} = V_{EN}/UVLO = 24V$ ,  $V_{GND} = 0V$ ,  $C_{VCC} = 1\mu F$ ,  $FB = 1V$  (MAXM15467),  $FB = 3.6V$  (MAXM15465)  $FB = 5.5V$  (MAXM15466),  $LX = MODE = \overline{RESET} = OUT =$  unconnected;  $T_A = -40^\circ C$  to  $+125^\circ C$ , unless otherwise noted. Typical values are at  $T_A = +25^\circ C$ . All voltages are referenced to GND, unless otherwise noted.) (Note 3)

PARAMETER	SYMBOL	CONDITIONS	MIN	TYP	MAX	UNITS
$V_{CC}$ Dropout	$V_{CC-DO}$	$V_{IN} = 4.5V$ , $I_{VCC} = 5mA$		0.15	0.3	V
$V_{CC}$ UVLO	$V_{CC-UVR}$	$V_{CC}$ rising	4.05	4.18	4.3	V
	$V_{CC-UVF}$	$V_{CC}$ falling	3.7	3.8	3.95	
<b>SOFT-START (SS)</b>						
Soft-Start Time	$t_{SS}$		3.5	3.75	4	ms
<b>FEEDBACK (FB)</b>						
FB-Regulation Voltage	$V_{FB-REG}$	MODE = GND, MAXM15467	0.887	0.90	0.913	V
		MODE = unconnected, MAXM15467	0.887	0.915	0.936	
		MODE = GND, MAXM15465	3.25	3.30	3.35	
		MODE = unconnected, MAXM15465	3.25	3.35	3.42	
		MODE = GND, MAXM15466	4.93	5.00	5.07	
		MODE = unconnected, MAXM15466	4.93	5.08	5.18	
FB-Leakage Current	$I_{FB}$	MAXM15467	-100	-25		nA
<b>TIMING</b>						
Switching Frequency	$f_{SW}$		515	550	585	kHz
FB Undervoltage Trip Level to Cause Hiccup			62.5	64.5	66.5	%
Hiccup Timeout				120		ms
Minimum On-Time	$t_{ON-MIN}$			90	120	ns
Maximum Duty Cycle	$D_{MAX}$	$FB = 0.98 \times FB_{REG}$	89	91.4	94	%
<b><math>\overline{RESET}</math></b>						
FB Threshold for $\overline{RESET}$ Rising		FB rising	93.5	95.5	97.5	%
FB Threshold for $\overline{RESET}$ Falling		FB falling	90	92	94	%
$\overline{RESET}$ Delay After FB Reaches Rising Threshold				1.9		ms
$\overline{RESET}$ Output-Level Low		$I_{\overline{RESET}} = 5mA$			0.2	V
$\overline{RESET}$ Output-Leakage Current		$V_{\overline{RESET}} = 5.5V$ , $T_A = +25^\circ C$			0.1	$\mu A$
<b>MODE</b>						
MODE Internal Pullup Resistor				500		k $\Omega$
<b>THERMAL SHUTDOWN</b>						
Thermal-Shutdown Threshold		Temperature rising		166		$^\circ C$
Thermal-Shutdown Hysteresis				10		$^\circ C$

**Note 3:** Electrical specifications are production tested at  $T_A = +25^\circ C$ . Specifications over the entire operating temperature range are guaranteed by design and characterization.

### Typical Operating Characteristics

( $V_{IN} = V_{EN/UVLO} = 24V$ ,  $V_{GND} = 0V$ ,  $T_A = -40^{\circ}C$  to  $+125^{\circ}C$ , unless otherwise noted. Typical values are at  $T_A = +25^{\circ}C$ . All voltages are referenced to GND, unless otherwise noted. The circuit values for different output-voltage applications are as in [Table 1](#), unless otherwise noted.)

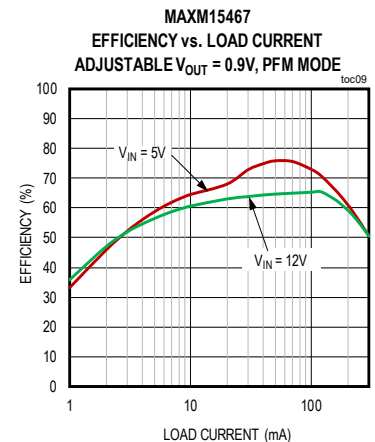
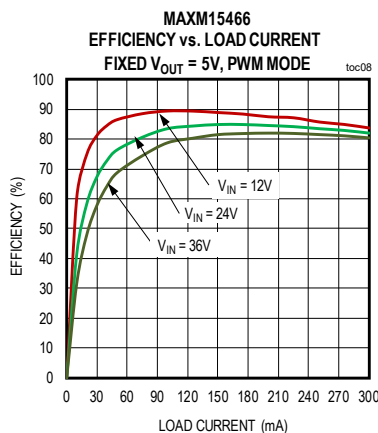
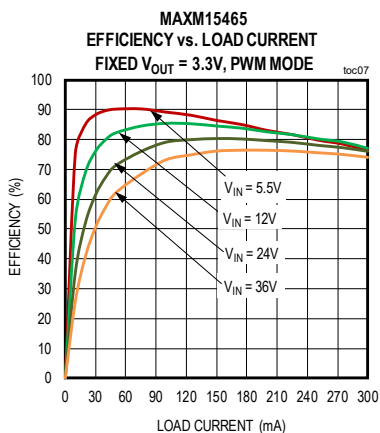
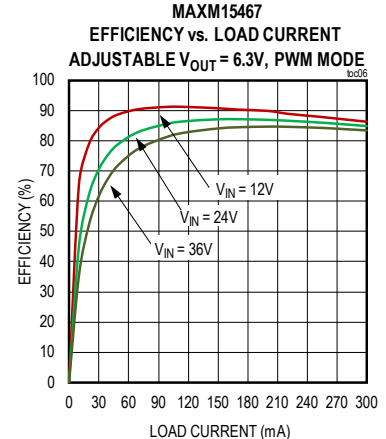
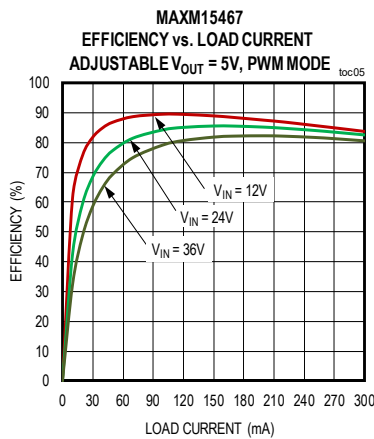
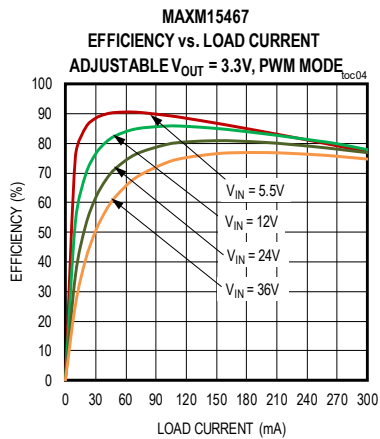
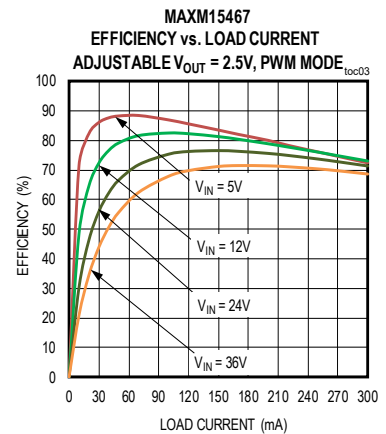
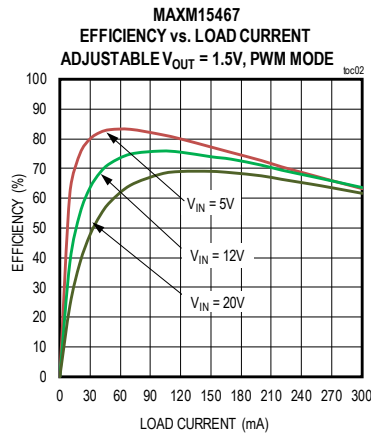
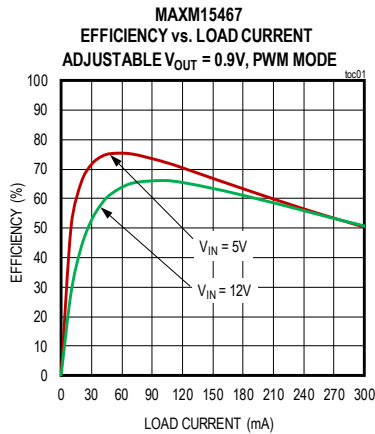

Typical Operating Characteristics (continued)

( $V_{IN} = V_{EN/UVLO} = 24V$ ,  $V_{GND} = 0V$ ,  $T_A = -40^{\circ}C$  to  $+125^{\circ}C$ , unless otherwise noted. Typical values are at  $T_A = +25^{\circ}C$ . All voltages are referenced to GND, unless otherwise noted. The circuit values for different output-voltage applications are as in Table 1, unless otherwise noted.)

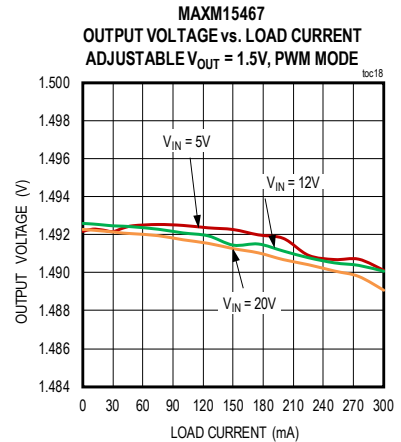
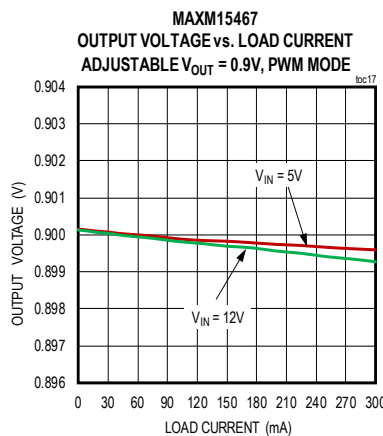
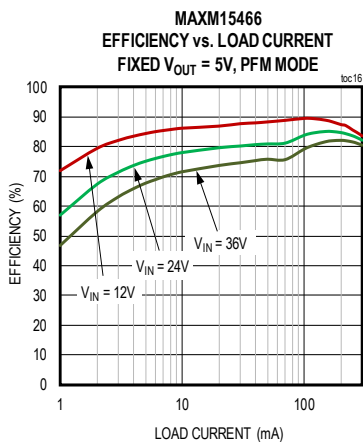
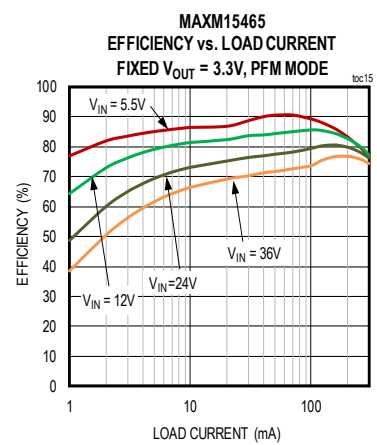
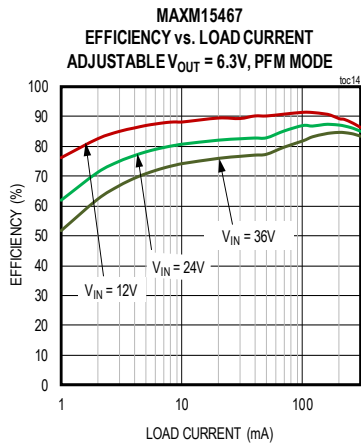
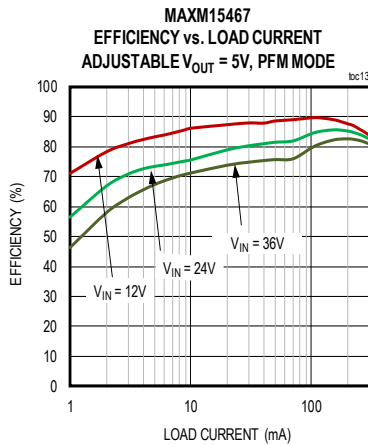
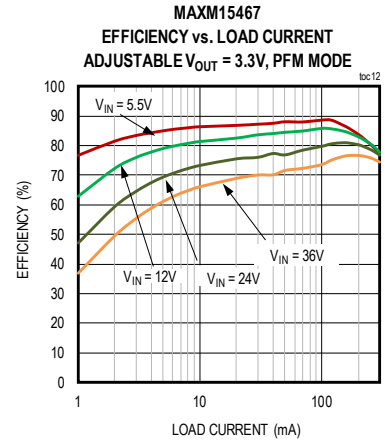
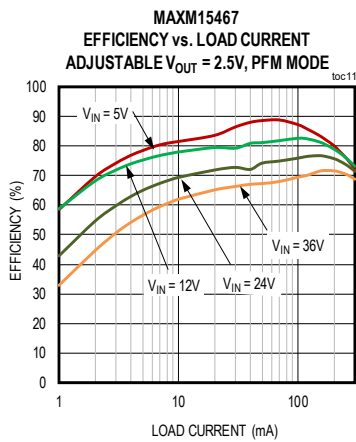
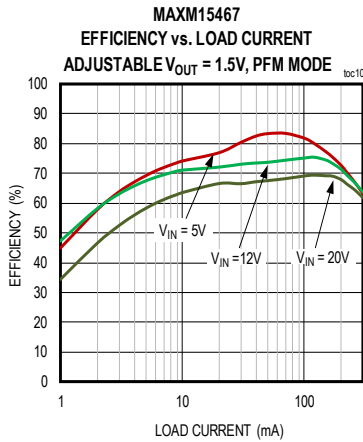

Typical Operating Characteristics (continued)

( $V_{IN} = V_{EN/UVLO} = 24V$ ,  $V_{GND} = 0V$ ,  $T_A = -40^{\circ}C$  to  $+125^{\circ}C$ , unless otherwise noted. Typical values are at  $T_A = +25^{\circ}C$ . All voltages are referenced to GND, unless otherwise noted. The circuit values for different output-voltage applications are as in Table 1, unless otherwise noted.)

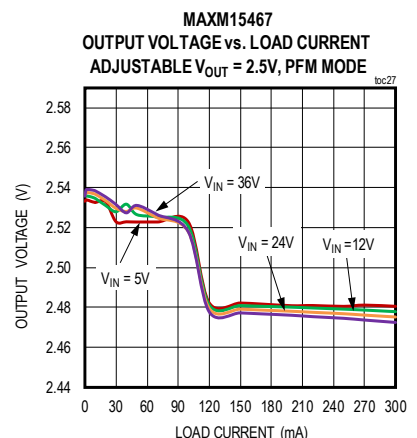
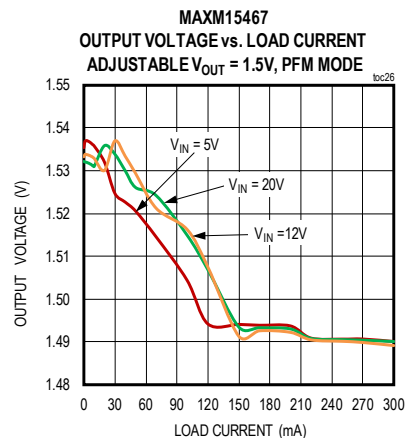
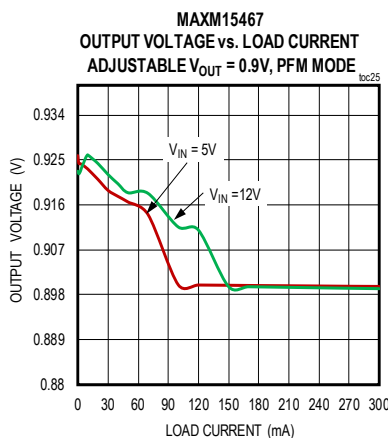
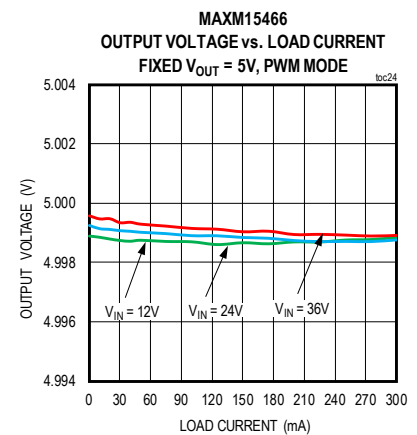
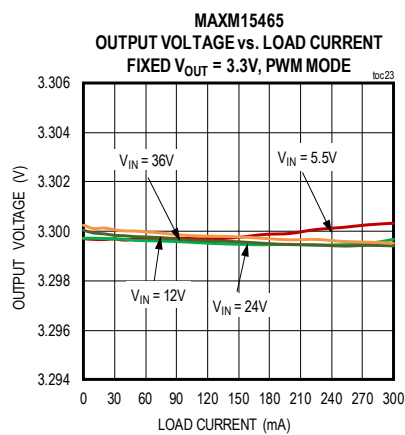
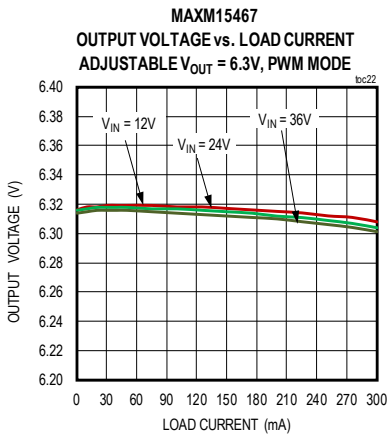
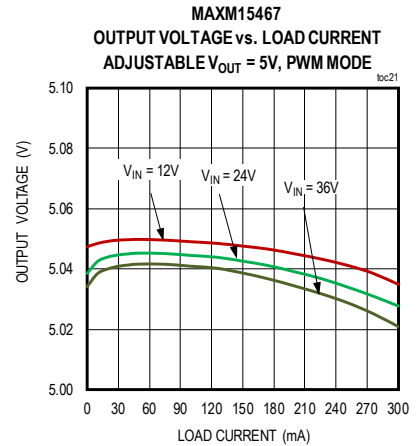
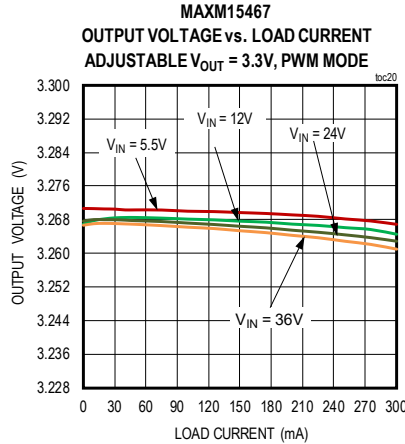
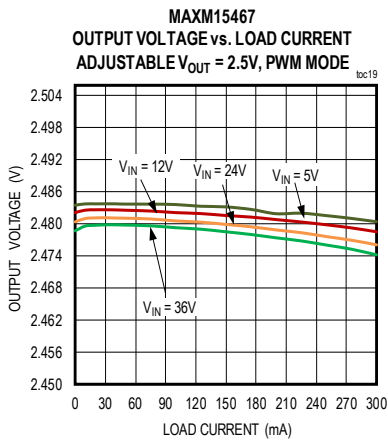

Typical Operating Characteristics (continued)

( $V_{IN} = V_{EN/UVLO} = 24V$ ,  $V_{GND} = 0V$ ,  $T_A = -40^{\circ}C$  to  $+125^{\circ}C$ , unless otherwise noted. Typical values are at  $T_A = +25^{\circ}C$ . All voltages are referenced to GND, unless otherwise noted. The circuit values for different output-voltage applications are as in Table 1, unless otherwise noted.)

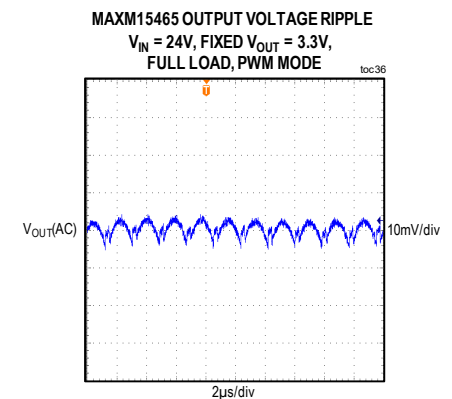
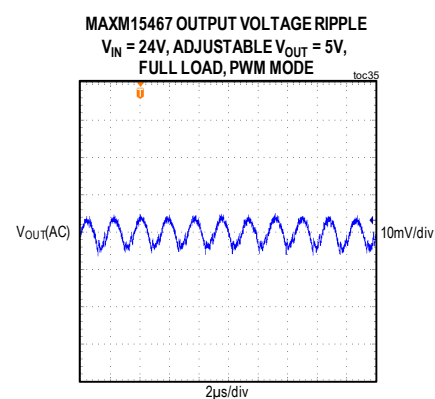
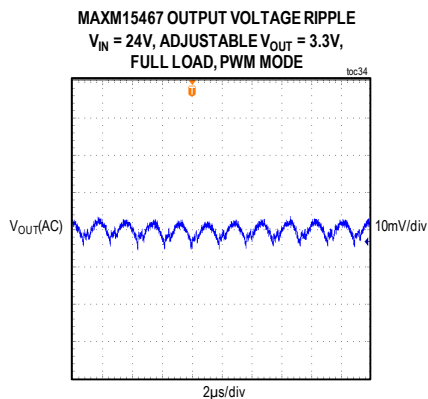
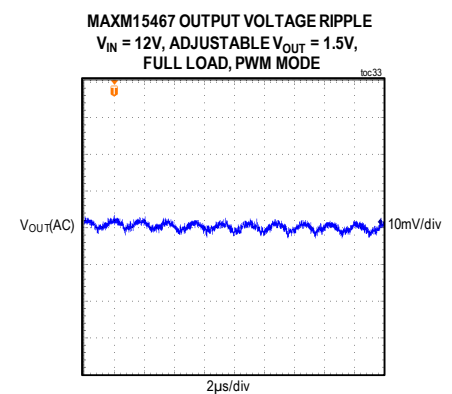
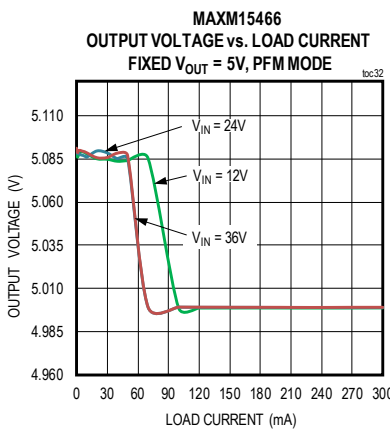
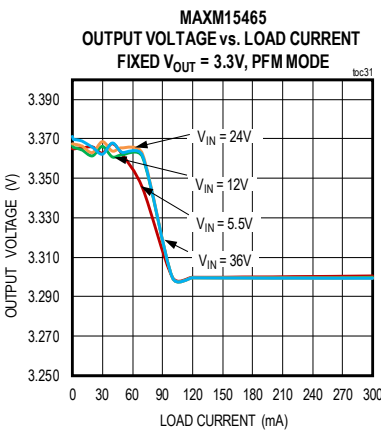
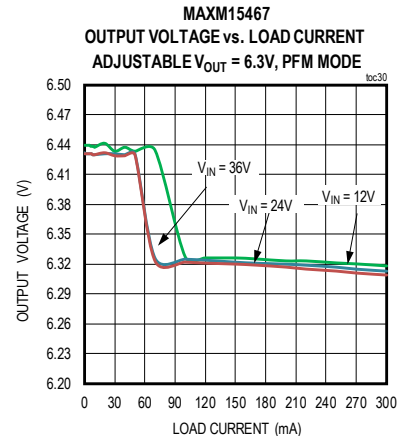
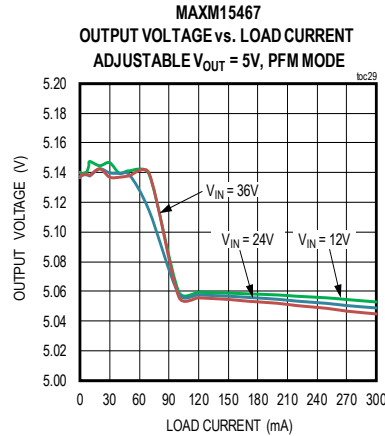
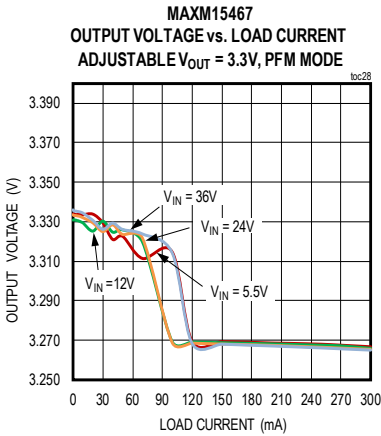

**Typical Operating Characteristics (continued)**

( $V_{IN} = V_{EN/UVLO} = 24V$ ,  $V_{GND} = 0V$ ,  $T_A = -40^{\circ}C$  to  $+125^{\circ}C$ , unless otherwise noted. Typical values are at  $T_A = +25^{\circ}C$ . All voltages are referenced to GND, unless otherwise noted. The circuit values for different output-voltage applications are as in [Table 1](#), unless otherwise noted.)

**MAXM15466 OUTPUT VOLTAGE RIPPLE**  
 $V_{IN} = 24V$ , FIXED  $V_{OUT} = 5V$   
FULL LOAD, PWM MODE

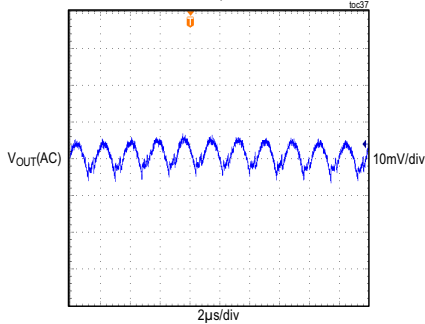

**MAXM15467 INPUT VOLTAGE RIPPLE**  
 $V_{IN} = 12V$ , ADJUSTABLE  $V_{OUT} = 1.5V$   
FULL LOAD, PWM MODE

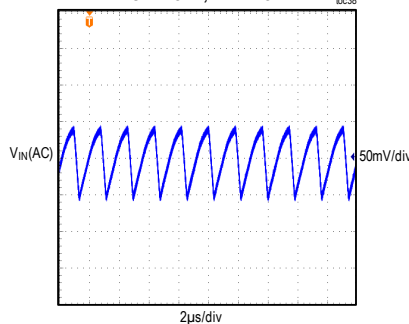

**MAXM15467 INPUT VOLTAGE RIPPLE**  
 $V_{IN} = 24V$ , ADJUSTABLE  $V_{OUT} = 3.3V$ ,  
FULL LOAD, PWM MODE

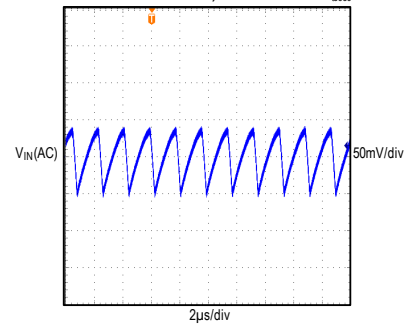

**MAXM15467 INPUT VOLTAGE RIPPLE**  
 $V_{IN} = 24V$ , ADJUSTABLE  $V_{OUT} = 5V$ ,  
FULL LOAD, PWM MODE

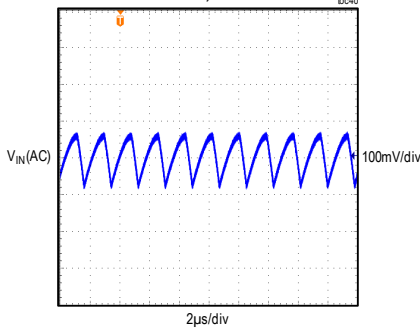

**MAXM15465 INPUT VOLTAGE RIPPLE**  
 $V_{IN} = 24V$ , FIXED  $V_{OUT} = 3.3V$ ,  
FULL LOAD, PWM MODE

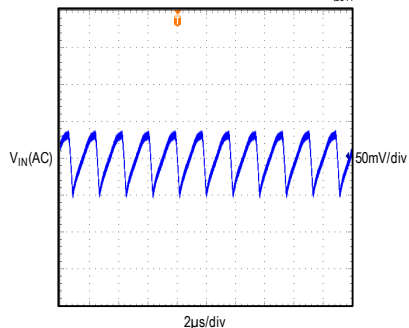

**MAXM15466 INPUT VOLTAGE RIPPLE**  
 $V_{IN} = 24V$ , FIXED  $V_{OUT} = 5V$   
FULL LOAD, PWM MODE

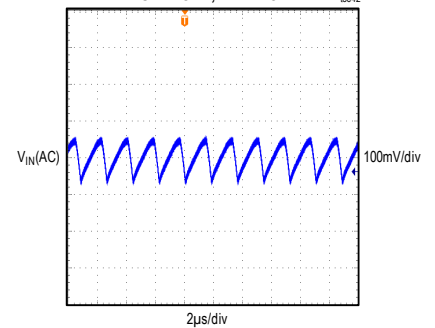

**MAXM15467 LOAD TRANSIENT RESPONSE**  
 $V_{IN} = 12V$ , ADJUSTABLE  $V_{OUT} = 1.5V$ , PFM MODE  
(LOAD CURRENT STEPPED FROM 5mA TO 150mA)

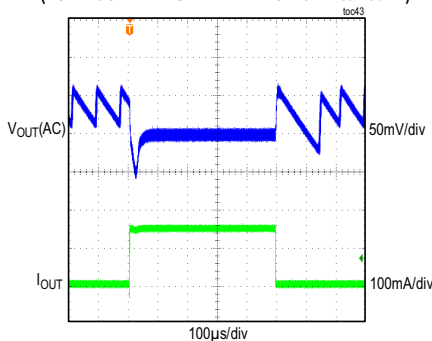

**MAXM15467 LOAD TRANSIENT RESPONSE**  
 $V_{IN} = 12V$ , ADJUSTABLE  $V_{OUT} = 1.5V$ , PWM MODE  
(LOAD CURRENT STEPPED FROM 150mA TO 300mA)

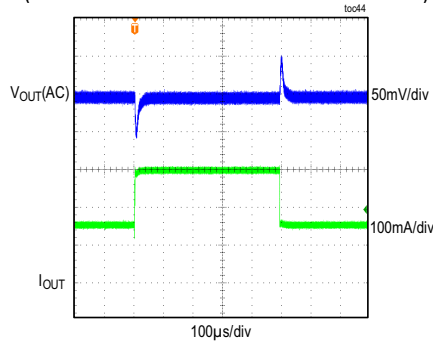

**MAXM15467 LOAD TRANSIENT RESPONSE**  
 $V_{IN} = 24V$ , ADJUSTABLE  $V_{OUT} = 3.3V$ , PFM MODE  
(LOAD CURRENT STEPPED FROM 5mA TO 150mA)

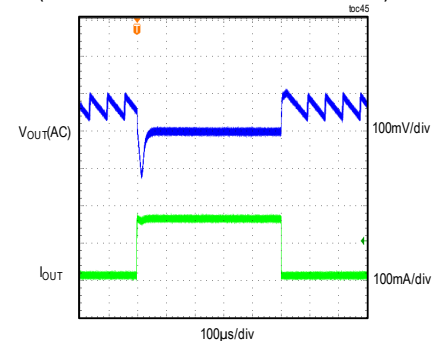



Typical Operating Characteristics (continued)

( $V_{IN} = V_{EN/UVLO} = 24V$ ,  $V_{GND} = 0V$ ,  $T_A = -40^{\circ}C$  to  $+125^{\circ}C$ , unless otherwise noted. Typical values are at  $T_A = +25^{\circ}C$ . All voltages are referenced to GND, unless otherwise noted. The circuit values for different output-voltage applications are as in Table 1, unless otherwise noted.)

MAXM15467 LOAD TRANSIENT RESPONSE  
 $V_{IN} = 24V$ , ADJUSTABLE  $V_{OUT} = 3.3V$ , PWM MODE  
(LOAD CURRENT STEPPED FROM 150mA TO 300mA)

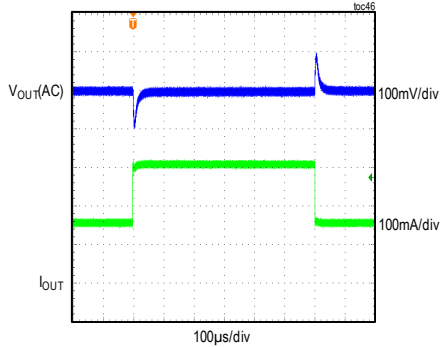

MAXM15467 LOAD TRANSIENT RESPONSE  
 $V_{IN} = 24V$ , ADJUSTABLE  $V_{OUT} = 5V$ , PFM MODE  
(LOAD CURRENT STEPPED FROM 5mA TO 150mA)

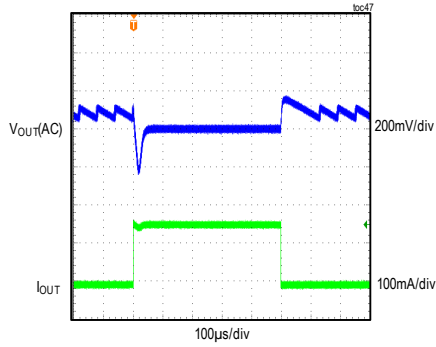

MAXM15467 LOAD TRANSIENT RESPONSE  
 $V_{IN} = 24V$ , ADJUSTABLE  $V_{OUT} = 5V$ , PWM MODE  
(LOAD CURRENT STEPPED FROM 150mA TO 300mA)

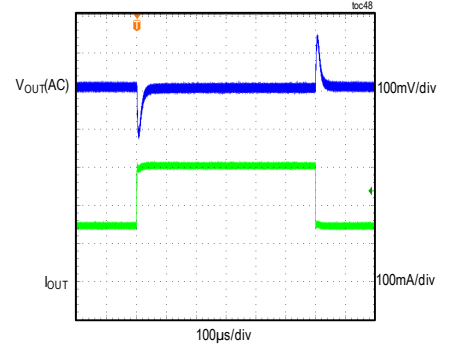

MAXM15465 LOAD TRANSIENT RESPONSE  
 $V_{IN} = 24V$ , FIXED  $V_{OUT} = 3.3V$ , PFM MODE  
(LOAD CURRENT STEPPED FROM 5mA TO 150mA)

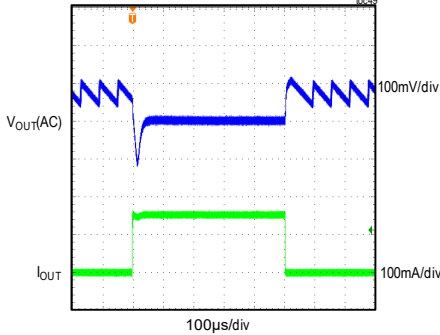

MAXM15465 LOAD TRANSIENT RESPONSE  
 $V_{IN} = 24V$ , FIXED  $V_{OUT} = 3.3V$ , PWM MODE  
(LOAD CURRENT STEPPED FROM 150mA TO 300mA)

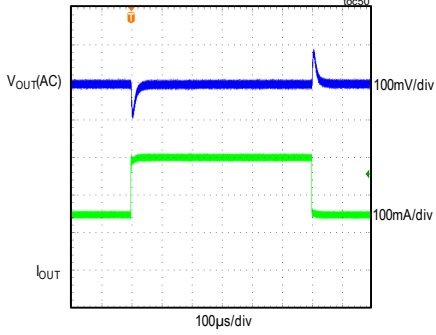

MAXM15466 LOAD TRANSIENT RESPONSE  
 $V_{IN} = 24V$ , FIXED  $V_{OUT} = 5V$ , PFM MODE  
(LOAD CURRENT STEPPED FROM 5mA TO 150mA)

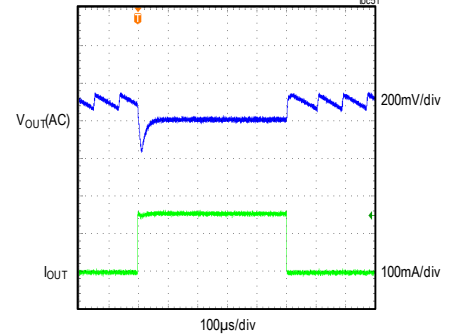

MAXM15466 LOAD TRANSIENT RESPONSE  
 $V_{IN} = 24V$ , FIXED  $V_{OUT} = 5V$ , PWM MODE  
(LOAD CURRENT STEPPED FROM 150mA TO 300mA)

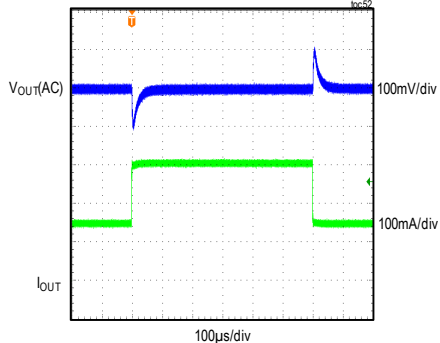

MAXM15467 STARTUP THROUGH ENABLE  
 $V_{IN} = 12V$ , ADJUSTABLE  $V_{OUT} = 1.5V$ ,  
FULL LOAD, PWM MODE

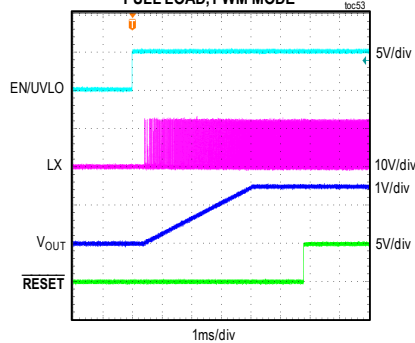

MAXM15467 SHUTDOWN THROUGH ENABLE  
 $V_{IN} = 12V$ , ADJUSTABLE  $V_{OUT} = 1.5V$ ,  
FULL LOAD, PWM MODE

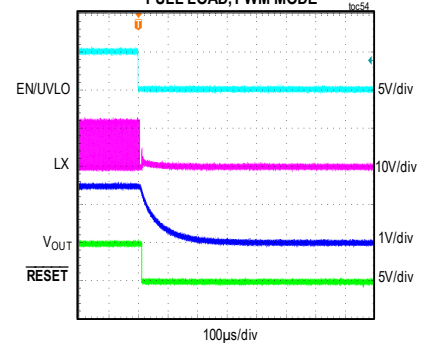

**Typical Operating Characteristics (continued)**

( $V_{IN} = V_{EN/UVLO} = 24V$ ,  $V_{GND} = 0V$ ,  $T_A = -40^{\circ}C$  to  $+125^{\circ}C$ , unless otherwise noted. Typical values are at  $T_A = +25^{\circ}C$ . All voltages are referenced to GND, unless otherwise noted. The circuit values for different output-voltage applications are as in [Table 1](#), unless otherwise noted.)

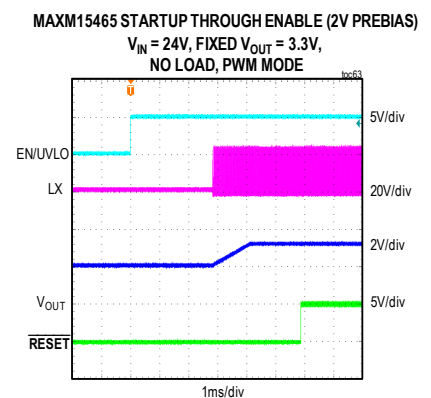
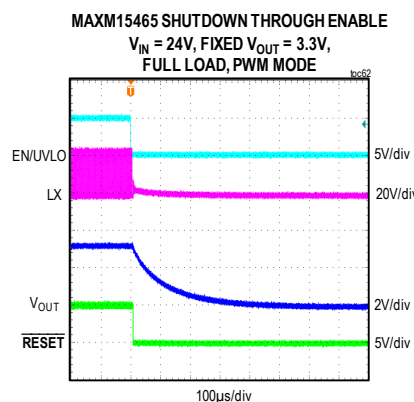
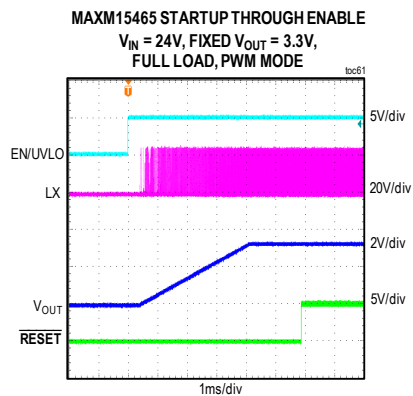
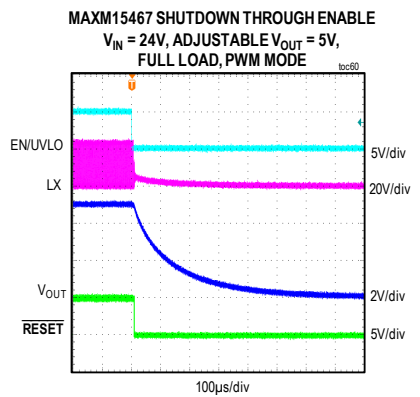
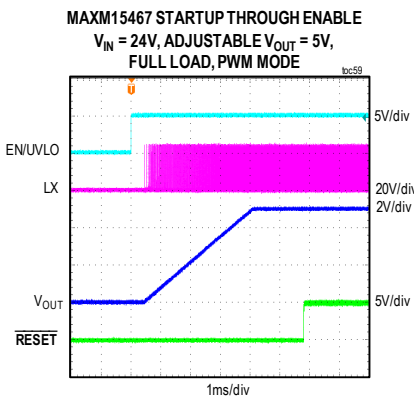
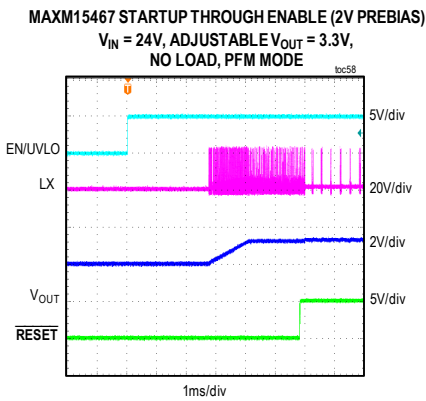
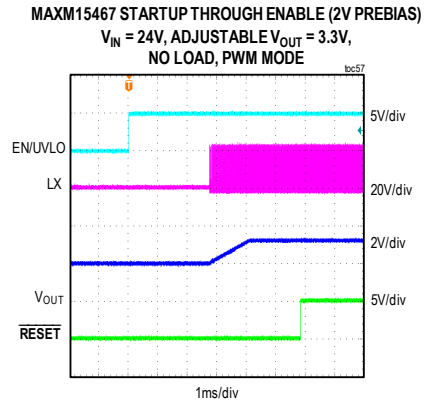
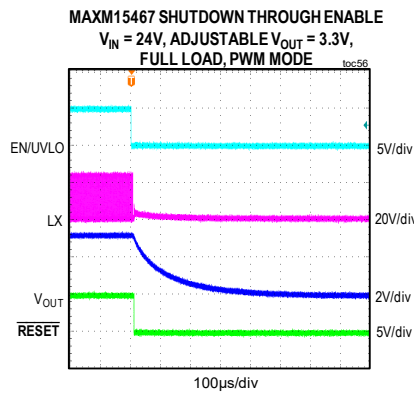
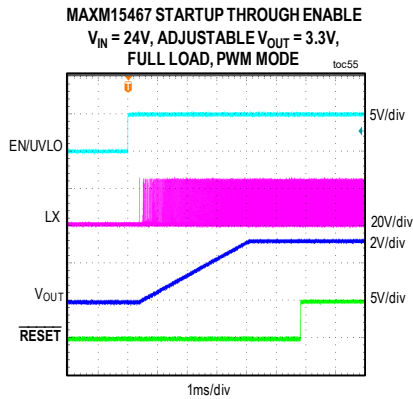

Typical Operating Characteristics (continued)

( $V_{IN} = V_{EN/UVLO} = 24V$ ,  $V_{GND} = 0V$ ,  $T_A = -40^{\circ}C$  to  $+125^{\circ}C$ , unless otherwise noted. Typical values are at  $T_A = +25^{\circ}C$ . All voltages are referenced to GND, unless otherwise noted. The circuit values for different output-voltage applications are as in Table 1, unless otherwise noted.)

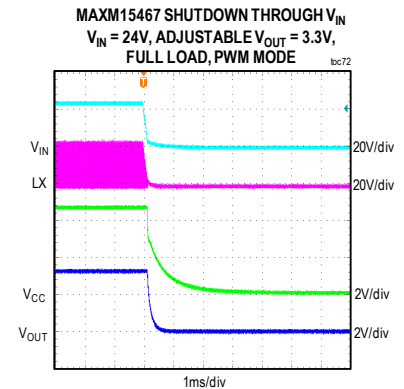
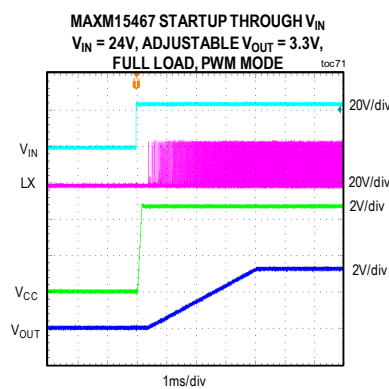
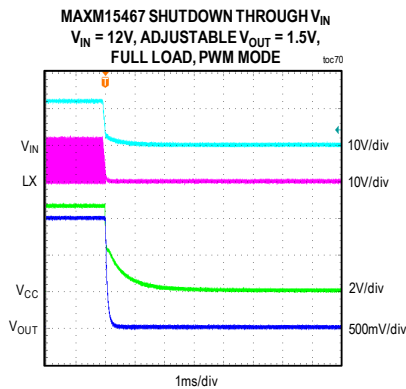
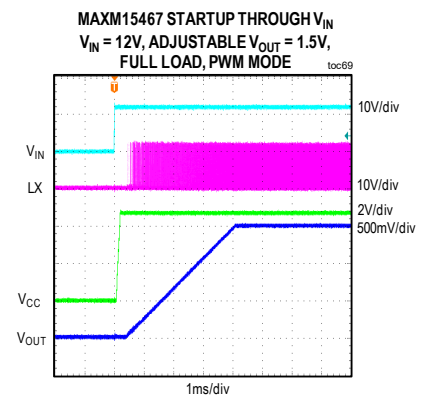
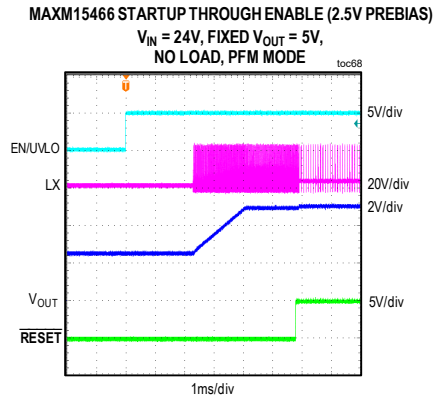
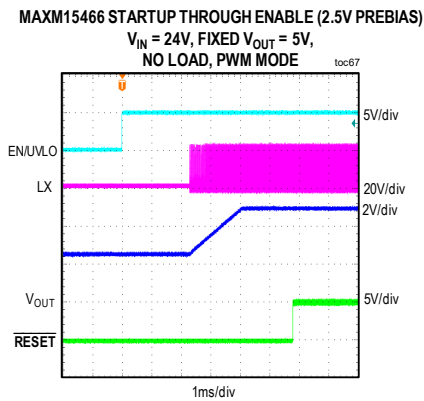
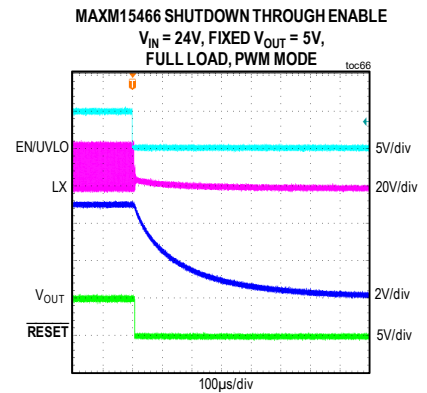
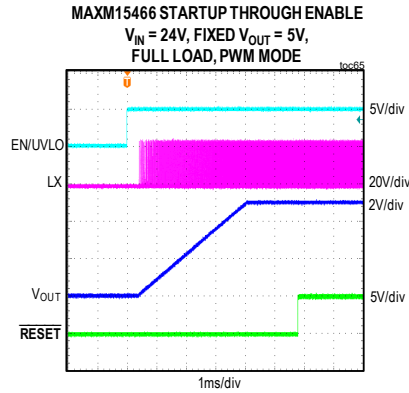
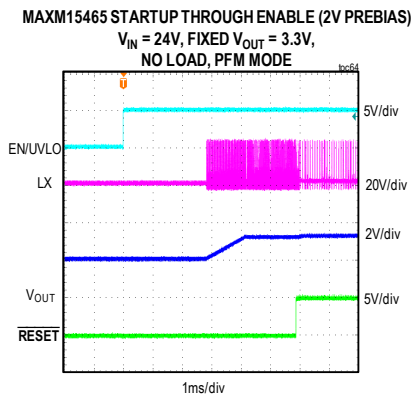

Typical Operating Characteristics (continued)

( $V_{IN} = V_{EN}/UV_{LO} = 24V$ ,  $V_{GND} = 0V$ ,  $T_A = -40^{\circ}C$  to  $+125^{\circ}C$ , unless otherwise noted. Typical values are at  $T_A = +25^{\circ}C$ . All voltages are referenced to GND, unless otherwise noted. The circuit values for different output-voltage applications are as in [Table 1](#), unless otherwise noted.)

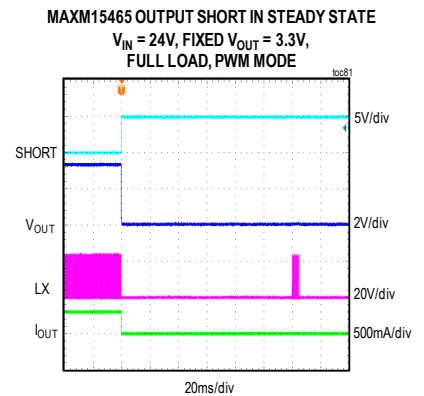
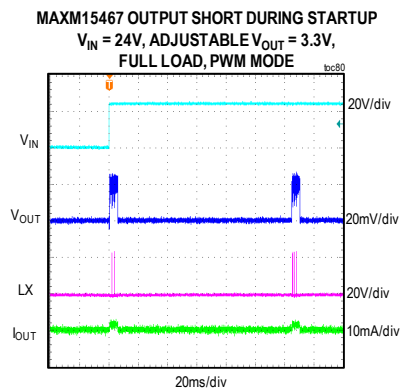
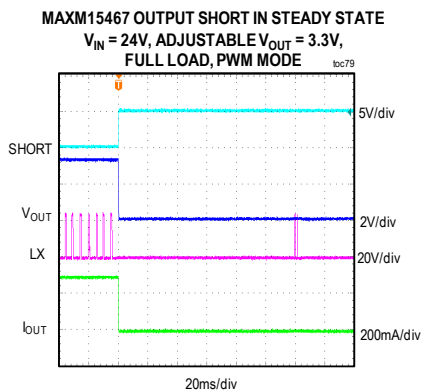
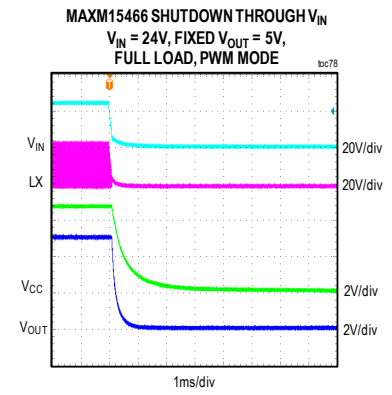
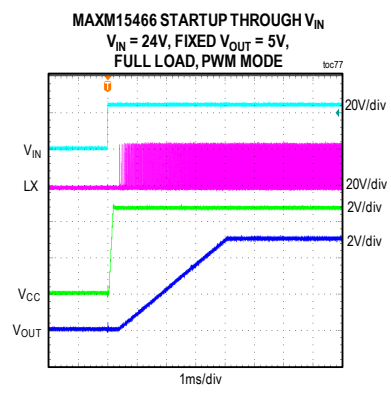
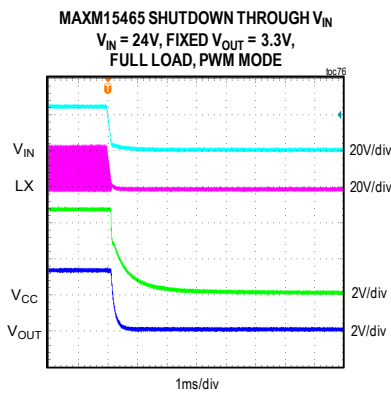
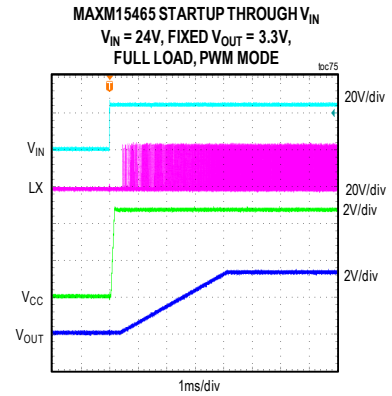
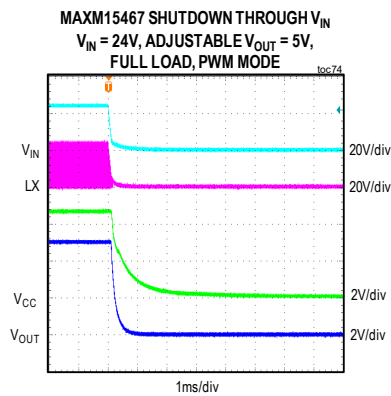
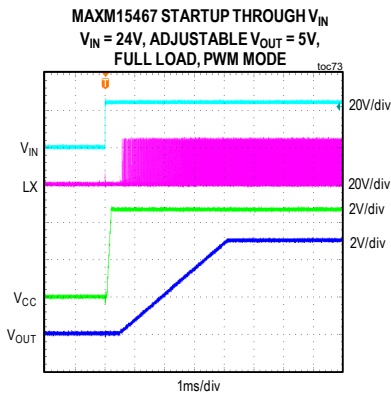

Typical Operating Characteristics (continued)

( $V_{IN} = V_{EN}/UVLO = 24V$ ,  $V_{GND} = 0V$ ,  $T_A = -40^{\circ}C$  to  $+125^{\circ}C$ , unless otherwise noted. Typical values are at  $T_A = +25^{\circ}C$ . All voltages are referenced to GND, unless otherwise noted. The circuit values for different output-voltage applications are as in [Table 1](#), unless otherwise noted.)

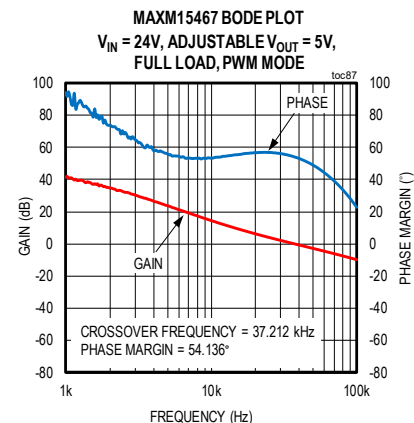
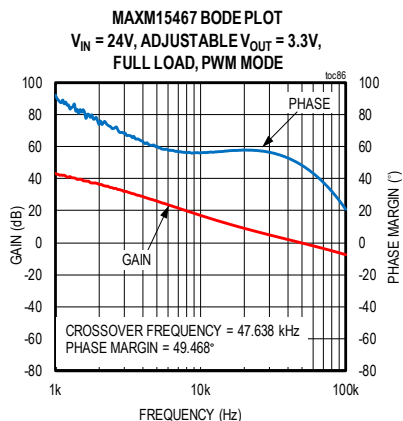
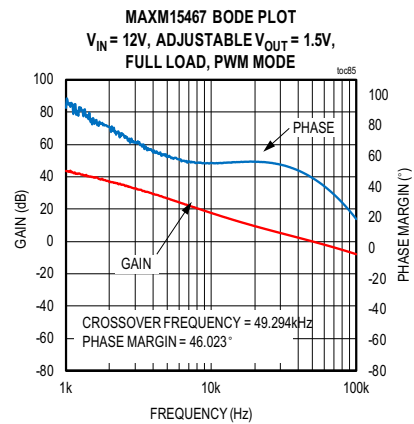
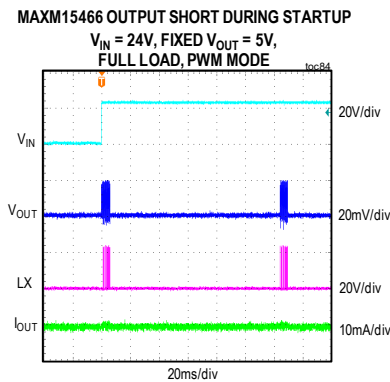
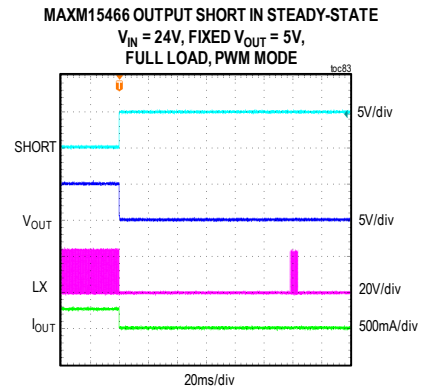
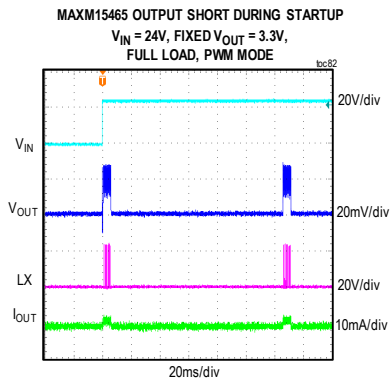

Typical Operating Characteristics (continued)

( $V_{IN} = V_{EN}/UV_{LO} = 24V$ ,  $V_{GND} = 0V$ ,  $T_A = -40^{\circ}C$  to  $+125^{\circ}C$ , unless otherwise noted. Typical values are at  $T_A = +25^{\circ}C$ . All voltages are referenced to GND, unless otherwise noted. The circuit values for different output-voltage applications are as in Table 1, unless otherwise noted.)

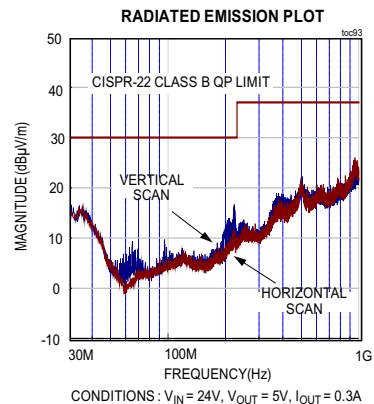
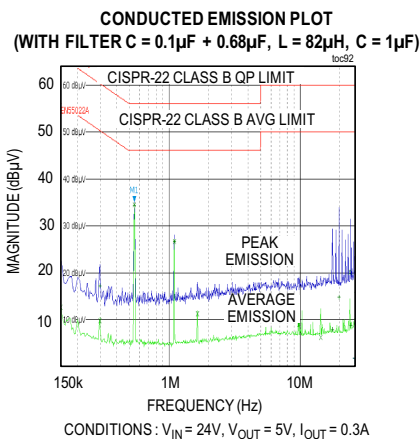
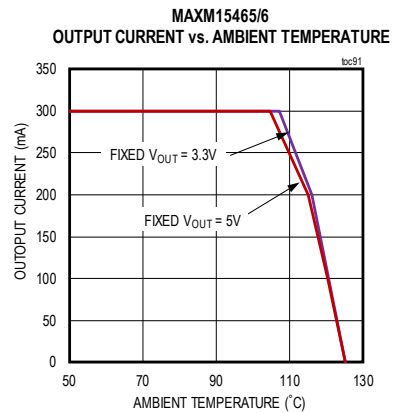
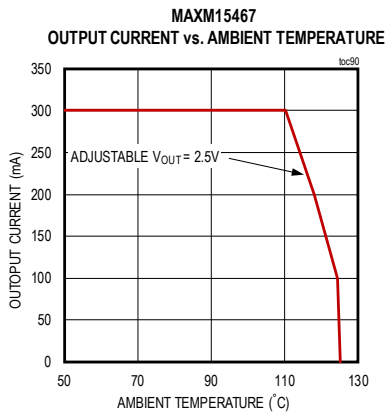
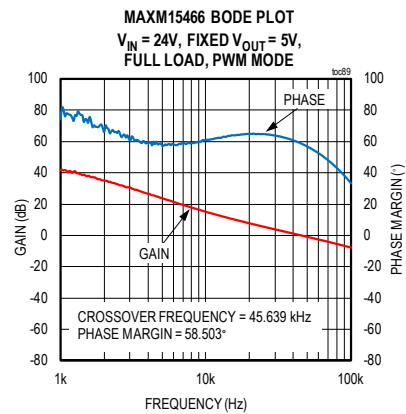
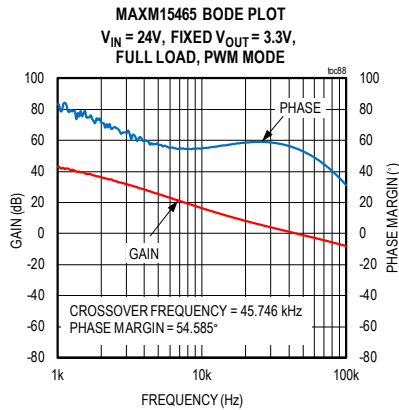

## Pin Configuration

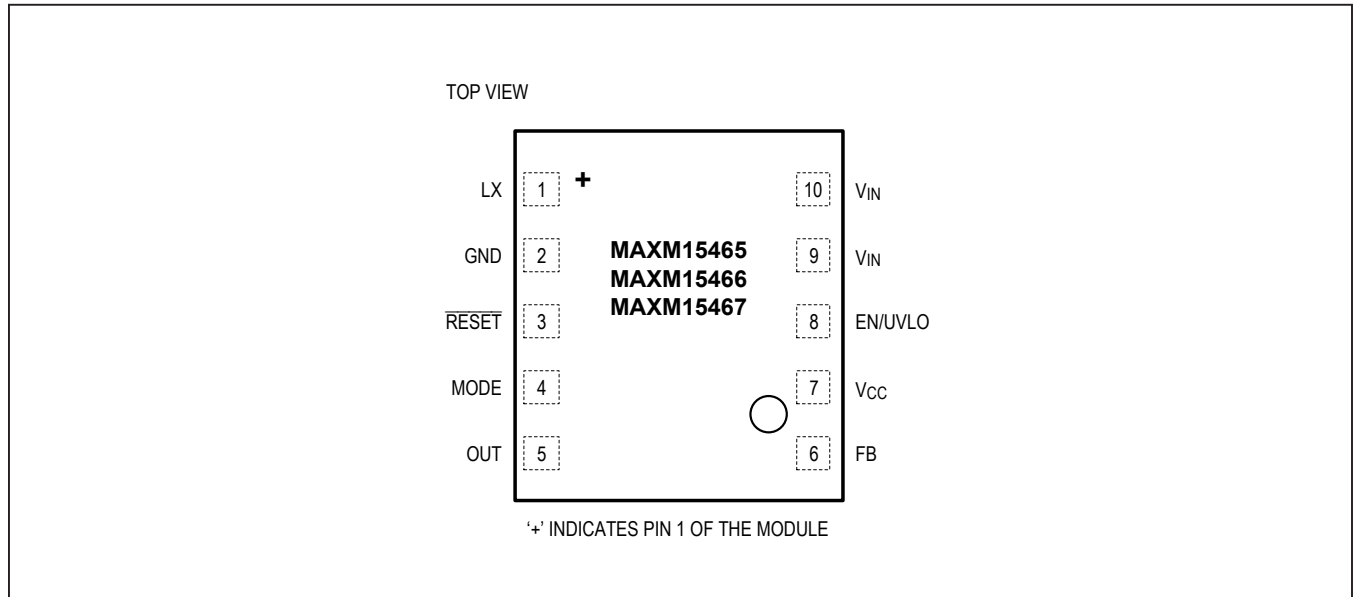

## Pin Description

PIN	NAME	FUNCTION
1	LX	Switching Node of the Inductor. No external connection to this pin.
2	GND	Ground Pin. Connect GND to the ground plane. See the <a href="#">PCB Layout Guidelines</a> section for more details. Refer to the MAXM15467 EV kit for a sample layout.
3	$\overline{\text{RESET}}$	Open-Drain Power-Good Output. Pull up $\overline{\text{RESET}}$ to an external power supply with an external resistor. $\overline{\text{RESET}}$ goes low if FB drops below 92% of its set value. $\overline{\text{RESET}}$ goes high impedance 1.9ms after FB rises above 95.5% of its set value. See the <a href="#">Electrical Characteristics</a> table for threshold values.
4	MODE	PFM/PWM Mode-Selection Input. Connect MODE to GND to enable fixed-frequency PWM operation at all loads. Leave MODE unconnected for PFM operation at light load.
5	OUT	Module Output Pin. Connect a capacitor from OUT to GND. See the <a href="#">PCB Layout Guidelines</a> section for more details.
6	FB	Output Feedback Connection. Connect FB to a resistor-divider between OUT and GND to set the output voltage for MAXM15467. Connect to output voltage node ( $V_{\text{OUT}}$ ) for MAXM15465 and MAXM15466. See <a href="#">Output-Voltage Setting</a> section for more details.
7	VCC	Internal LDO Power Output. Bypass VCC to GND with a minimum 1 $\mu$ F ceramic capacitor.
8	EN/UVLO	Active-High, Enable/Undervoltage-Detection Input. Pull EN/UVLO to GND to disable the module output. Connect EN/UVLO to V <sub>IN</sub> for always-on operation. Connect a resistor-divider between V <sub>IN</sub> , EN/UVLO, and GND to program the input voltage at which the module turns on.
9–10	V <sub>IN</sub>	Power-Supply Input. Connect the V <sub>IN</sub> pins together. Decouple to GND with a capacitor; place the capacitor close to the V <sub>IN</sub> and GND pins. See <a href="#">Table 1</a> for more details.

## Functional Diagrams

### Internal Diagram

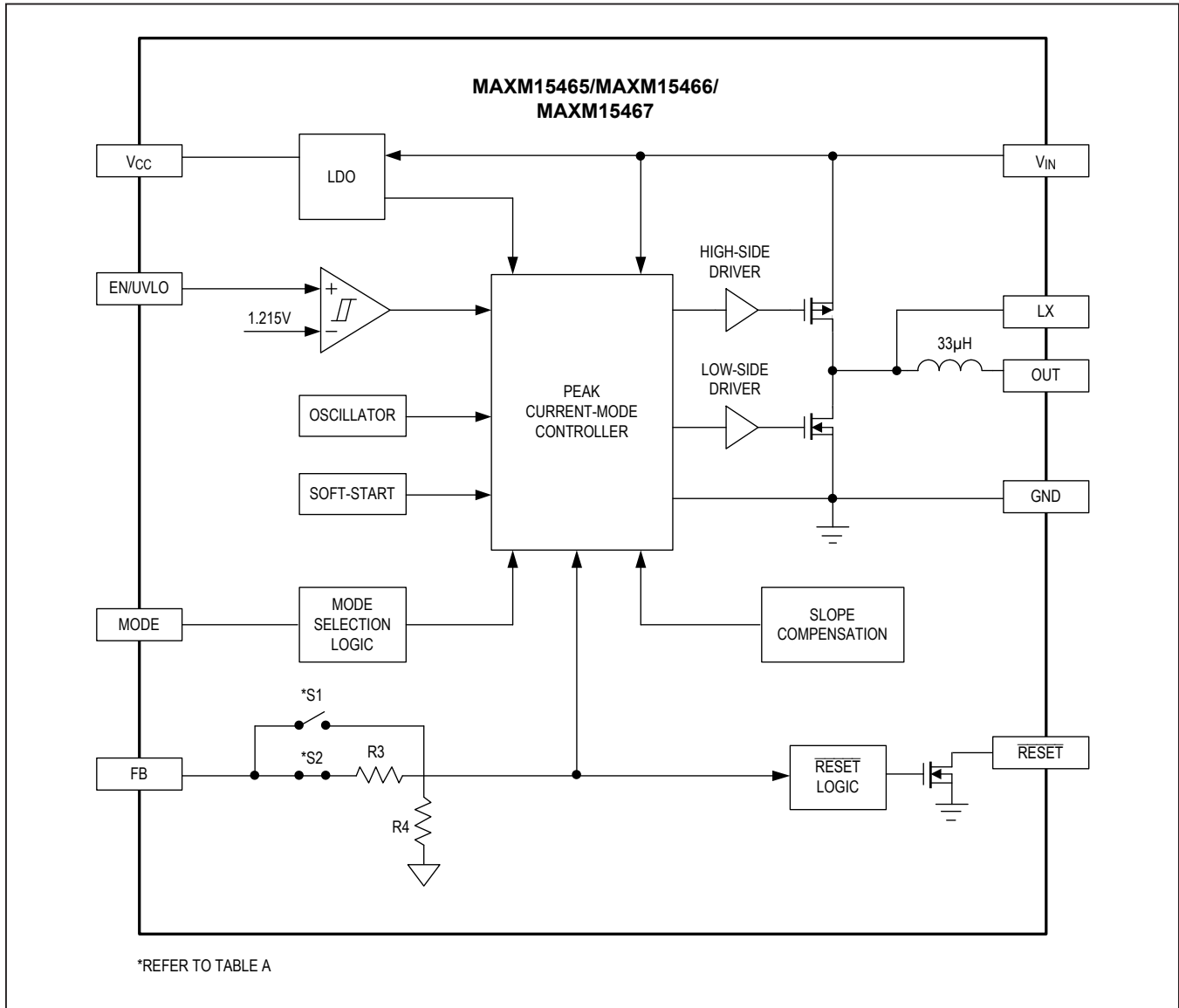

**Table A**

MODULE PART NUMBER	S1	S2	R3 (KΩ)	R4 (KΩ)
MAXM15467	CLOSE	OPEN	OPEN	OPEN
MAXM15465	OPEN	CLOSE	205.33	77
MAXM15466	OPEN	CLOSE	350.80	77



## Detailed Description

The MAXM15465/MAXM15466/MAXM15467 are a family of high-efficiency, synchronous step-down DC-DC modules with integrated controller, MOSFETs, compensation components, and inductor that operate over a wide input-voltage range. The modules deliver an output current up to 300mA. The MAXM15465 and MAXM15466 are fixed 3.3V and 5V output modules respectively. The MAXM15467 is an adjustable output (0.9V to 6.3V) module. When EN/UVLO and  $V_{CC}$  UVLO are ascertained, an internal power-up sequence ramps up the error-amplifier reference, resulting in an output-voltage soft-start.

The FB pin monitors the output voltage through a resistor-divider. The  $\overline{\text{RESET}}$  pin transitions to a high-impedance state 1.9ms after the output voltage reaches 95.5% of regulation. The devices select either PFM or forced-PWM mode depending on the state of the MODE pin at power-up. By pulling the EN/UVLO pin to low, the devices enter shutdown mode and consumes only 2.2 $\mu$ A (typ) of standby current.

The modules use an internally compensated, fixed-frequency, current-mode control scheme. On the rising edge of an internal clock, the high-side pMOSFET turns on. An internal error amplifier compares the feedback voltage to a fixed internal reference voltage and generates an error voltage. The error voltage is compared to a sum of the current-sense voltage and a slope-compensation voltage by a PWM comparator to set the on-time. During the on-time of the pMOSFET, the inductor current ramps up. For the remainder of the switching period (off-time), the pMOSFET is kept off and the low-side nMOSFET turns on. During the off-time, the inductor releases the stored energy as the inductor current ramps down, providing current to the output. Under overload conditions, the cycle-by-cycle current-limit feature limits the inductor peak current by turning off the high-side pMOSFET and turning on the low-side nMOSFET.

### Mode Selection (MODE)

The logic state of the MODE pin is latched after  $V_{CC}$  and EN/UVLO voltages exceed respective UVLO rising thresholds and all internal voltages are ready to allow LX switching. If the MODE pin is unconnected at power-up, the part operates in PFM mode at light loads. If the MODE pin is grounded at power-up, the part operates in constant-frequency PWM mode at all loads. State changes on the MODE pin are ignored during normal operation.

### PWM Operation

In PWM mode, the module output current is allowed to go negative. PWM operation is useful in frequency sensitive applications and provides fixed switching frequency

operation at all loads. However, PWM-mode of operation gives lower efficiency at light loads compared to PFM-mode of operation.

### PFM Operation

PFM mode operation disables negative output current from the module, and skips pulses at light loads for better efficiency. In PFM mode, the module output current is forced to a fixed peak of 130mA in every clock cycle until the output voltage rises to 102.3% of the nominal value. Once the output voltage reaches 102.3% of the nominal value, the high-side switch is turned off and the low-side switch is turned on. Once the module output current hits zero cross, LX goes to a high-impedance state and the module enters hibernate operation until the load current discharges the output voltage to 101.1% of the nominal value. Most of the internal blocks are turned off in hibernate operation to save quiescent current. When the output voltage falls below 101.1% of the nominal value, the module comes out of hibernate operation, turns on all internal blocks, and commences the process of delivering pulses of energy until the output voltage reaches 102.3% of the nominal value. The module naturally comes out of PFM mode and serves load requirements when the module output demands more than 130mA peak. The advantage of PFM mode is higher efficiency at light loads because of lower quiescent current drawn from supply.

### Internal 5V Regulator

An internal regulator provides a 5V nominal supply to power the internal functions and to drive the power MOSFETs. The output of the linear regulator ( $V_{CC}$ ) should be bypassed with a 1 $\mu$ F ceramic capacitor to GND. The  $V_{CC}$  regulator dropout voltage is typically 150mV. An undervoltage lockout circuit that disables the buck converter when  $V_{CC}$  falls below 3.8V (typ). The 400mV,  $V_{CC}$ -UVLO hysteresis prevents chattering on power-up and power-down.

### Enable/Undervoltage Lockout (EN/UVLO), Soft-Start

When EN/UVLO voltage is above 1.215V (typ), the device's internal error-amplifier reference voltage starts to ramp up. The duration of the soft-start ramp is 3.75ms (typ), allowing a smooth increase of the output voltage. Driving EN/UVLO low disables both power MOSFETs, as well as other internal circuitry, and reduces  $V_{IN}$  quiescent current to below 2.2 $\mu$ A. EN/UVLO can be used as an input-voltage UVLO adjustment input. An external voltage-divider between  $V_{IN}$  and EN/UVLO to GND adjusts the input voltage at which the device turns on or turns off. If input UVLO programming is not desired, connect EN/UVLO to  $V_{IN}$  (see the [Electrical Characteristics](#) table for EN/UVLO rising and falling threshold voltages).

### RESET Output ( $\overline{\text{RESET}}$ )

The devices include an open-drain  $\overline{\text{RESET}}$  output to monitor the output voltage.  $\overline{\text{RESET}}$  goes high impedance 1.9ms after the output rises above 95.5% of its nominal set value and pulls low when the output voltage falls below 92% of the set nominal regulated voltage.  $\overline{\text{RESET}}$  asserts low during the hiccup timeout period.

### Startup into a Prebiased Output

The devices are capable of soft-start into a prebiased output, without discharging the output capacitor in both the PFM and forced-PWM modes. Such a feature is useful in applications where digital integrated circuits with multiple rails are powered.

### Overcurrent Protection (OCP)/Hiccup Mode

The MAXM15465/MAXM15466/MAXM15467 are provided with a robust overcurrent protection (OCP) scheme that protects the modules under overload and output short-circuit conditions. The power module measures and limits peak inductor current. When overcurrent is detected in the inductor, or if the FB node goes below 64.5% of its nominal regulation threshold, the module enters hiccup mode of operation. In hiccup mode, the module is protected by suspending switching for a hiccup timeout period of 120ms (typ). Once the hiccup timeout period expires, soft-start is attempted again. Hiccup mode of operation ensures low power dissipation under output overload or short-circuit conditions. Once the hiccup timeout period expires, soft-start is attempted again.

The MAXM15465/6/7 are designed to support a maximum load current of 300mA. The inductor ripple current is calculated as follows:

$$\Delta I = \left[ \frac{V_{\text{IN}} - V_{\text{OUT}} - 4.85 \times I_{\text{OUT}}}{L \times f_{\text{SW}}} \right] \times \left[ \frac{V_{\text{OUT}} + 3.05 \times I_{\text{OUT}}}{V_{\text{IN}} - 1.8 \times I_{\text{OUT}}} \right]$$

Where:

$V_{\text{OUT}}$  = Steady-state output voltage

$V_{\text{IN}}$  = Operating input voltage for given  $V_{\text{OUT}}$

$f_{\text{SW}}$  = Switching Frequency

$L$  = Power module output inductance (33 $\mu\text{H}$   $\pm$ 30%)

$I_{\text{OUT}}$  = Required output (load) current

The following condition should be satisfied at the desired load current,  $I_{\text{OUT}}$ .

$$I_{\text{OUT}} + \frac{\Delta I}{2} < 0.49$$

### Thermal Overload Protection

Thermal overload protection limits the total power dissipation in the device. When the junction temperature exceeds +166°C, an on-chip thermal sensor shuts down the device, turns off the internal power MOSFETs, allowing the device to cool down. The thermal sensor turns the device on after the junction temperature cools by 10°C.

## Applications Information

### Input-Voltage Range

The minimum and maximum operating input voltages for a given output voltage should be calculated as follows:

$$V_{\text{IN(MIN)}} = \frac{V_{\text{OUT}} + (I_{\text{OUT}} \times 3.05)}{D_{\text{MAX}}} + (I_{\text{OUT}} \times 1.8)$$

$$V_{\text{IN(MAX)}} = \frac{V_{\text{OUT}}}{t_{\text{ON(MIN)}} \times f_{\text{SW}}}$$

where:

$V_{\text{OUT}}$  = Steady-state output voltage,

$I_{\text{OUT}}$  = Maximum load current,

$f_{\text{SW}}$  = Worst-case switching frequency(585000 Hz),

$D_{\text{MAX}}$  = Maximum duty cycle (0.89),

$t_{\text{ON(MIN)}}$  = Worst-case minimum controllable switch on-time (120ns).

Also, for duty cycle > 0.5;

$$V_{\text{IN(MIN)}} > ((4.27 \times V_{\text{OUT}}) - 12.9)$$

For MAXM15465,  $V_{\text{IN(MIN)}} = 5.5\text{V}$ ,  $V_{\text{IN(MAX)}} = 42\text{V}$

For MAXM15466,  $V_{\text{IN(MIN)}} = 8.5\text{V}$ ,  $V_{\text{IN(MAX)}} = 42\text{V}$

### Selection of Input Capacitor

The input filter capacitor reduces peak currents drawn from the power source and reduces noise and voltage ripple on the input caused by the converter's switching.

The input capacitor RMS current requirement ( $I_{\text{RMS}}$ ) is defined by the following equation:

$$I_{\text{RMS}} = I_{\text{OUT(MAX)}} \times \frac{\sqrt{V_{\text{OUT}} \times (V_{\text{IN}} - V_{\text{OUT}})}}{V_{\text{IN}}}$$

where,  $I_{\text{OUT(MAX)}}$  is the maximum load current.  $I_{\text{RMS}}$  has a maximum value when the input voltage equals twice the output voltage ( $V_{\text{IN}} = 2 \times V_{\text{OUT}}$ ). So,

$$I_{\text{RMS(MAX)}} = \frac{I_{\text{OUT(MAX)}}}{2}$$

# MAXM15465/MAXM15466/ MAXM15467

# 4.5V to 42V, 300mA Himalaya uSLIC Step-Down Power Module

Choose an input capacitor that exhibits less than a +10°C temperature rise at the RMS input current for optimal long-term reliability. Use low-ESR ceramic capacitors with high-ripple-current capability at the input. X7R capacitors are recommended in industrial applications for their temperature stability. Calculate the input capacitance using the following equation:

$$C_{IN} = \frac{I_{OUT(MAX)} \times D_{MAX} \times (1 - D_{MAX})}{f_{SW} \times \Delta V_{IN}}$$

where:

$D_{MAX}$  = Maximum duty cycle(0.89),

$f_{SW}$  = Switching frequency,

$\Delta V_{IN}$  = Allowable input-voltage ripple.

### Selection of Output Capacitor

Small ceramic X7R-grade capacitors are sufficient and recommended for output-voltage generation. The output capacitor has two functions. It provides smooth voltage and, stores sufficient energy to support the output voltage under load transient conditions and stabilizes the device's internal control loop. Usually the output capacitor is sized to support a step load of 50% of the maximum output current in the application, such that the output-voltage deviation is less than 3%. Required output capacitance can be calculated from the following equation:

$$C_{OUT} = \frac{20}{V_{OUT}}$$

where  $C_{OUT}$  is the output capacitance in  $\mu F$  and  $V_{OUT}$  is the output voltage. Derating of ceramic capacitors with DC-voltage must be considered while selecting the output capacitor.

### Setting the Input Undervoltage-Lockout Level

The devices offer an adjustable input undervoltage lock-out level. Set the voltage at which the device turns on with a resistive voltage-divider connected from  $V_{IN}$  to GND (see [Figure 1](#)). Connect the center node of the divider to EN/UVLO.

Choose R1 to be 3.3M $\Omega$  (max), and then calculate R2 as follows:

$$R2 = \frac{R1 \times 1.215}{V_{INU} - 1.215}$$

where  $V_{INU}$  is the voltage at which the device is required to turn on.

If the EN/UVLO pin is driven from an external signal source, a series resistance of minimum 1k $\Omega$  is recommended to be placed between the signal source output and the EN/UVLO pin, to reduce voltage ringing on the line.

### Output-Voltage Setting

The MAXM15467 output voltage can be programmed from 0.9V to 6.3V. Set the output voltage by connecting a resistor-divider from output to FB to GND (see [Figure 2](#)).

Choose R4 less than or equal to 75k $\Omega$  and calculate R3 with the following equation:

$$R3 = R4 \times \left( \frac{V_{OUT}}{0.9} - 1 \right)$$

Connect FB of MAXM15465 and MAXM15466 directly to  $V_{OUT}$  for feedback control.

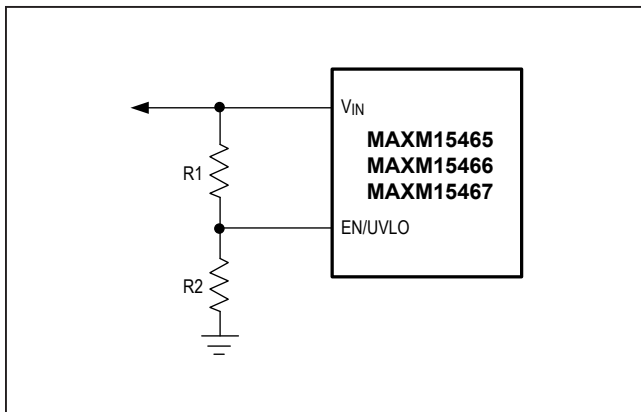

Figure 1. Adjustable EN/UVLO Network

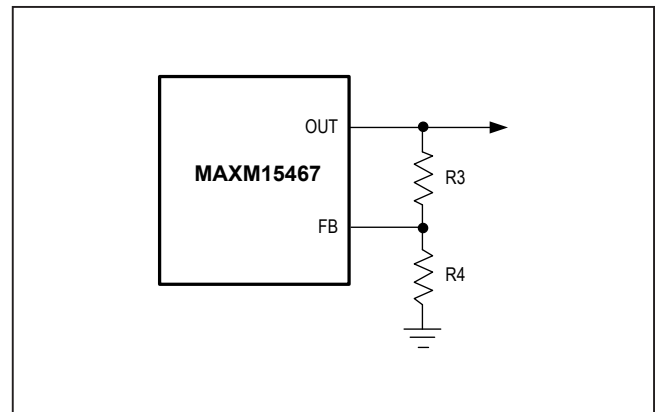

Figure 2. Setting the Output Voltage

**Table 1. Selection of Components**

PART NUMBER	V <sub>IN(MIN)</sub> (V)	V <sub>IN(MAX)</sub> (V)	V <sub>OUT*</sub> (V)	C <sub>IN</sub>	C <sub>OUT</sub>	R3 (kΩ)	R4 (kΩ)
MAXM15467	4.5	12.5	0.9	1 x 1μF 0805 25V (Murata GRM219R71E105KA88)	1 x 22μF 1206 6.3V (Murata GRM31CR70J226KE19L)	SHORT	OPEN
	4.5	14	1	1 x 1μF 0805 25V (Murata GRM219R71E105KA88)	1 x 22μF 1206 6.3V (Murata GRM31CR70J226KE19L)	8.33	75
	4.5	17	1.2	1 x 1μF 0805 25V (Murata GRM219R71E105KA88)	1 x 22μF 1206 6.3V (Murata GRM31CR70J226KE19L)	25	75
	4.5	21.5	1.5	1 x 1μF 0805 25V (Murata GRM219R71E105KA88)	1 x 10μF 1206 6.3V (Murata GRM31CR70J106KA01)	50	75
	4.5	25.5	1.8	1 x 1μF 0805 50V (Murata GRM21BR71H105KA12)	1 x 10μF 1206 6.3V (Murata GRM31CR70J106KA01)	75	75
	4.5	36	2.5	1 x 1μF 0805 50V (Murata GRM21BR71H105KA12)	1 x 10μF 0805 16V (Murata GRM21BZ71C106KE15)	133	75
	5.5	42	3.3	1 x 1μF 0805 50V (Murata GRM21BR71H105KA12)	1 x 10μF 0805 16V (Murata GRM21BZ71C106KE15)	200	75
	8.5	42	5	1 x 1μF 0805 50V (Murata GRM21BR71H105KA12)	1 x 10μF 0805 16V (Murata GRM21BZ71C106KE15)	348	75
	10	60	6.3	1 x 1μF 0805 50V (Murata GRM21BR71H105KA12)	1 x 10μF 0805 16V (Murata GRM21BZ71C106KE15)	450	75
MAXM15465	5.5	42	3.3	1 x 1μF 0805 50V (Murata GRM21BR71H105KA12)	1 x 10μF 0805 16V (Murata GRM21BZ71C106KE15)	N/A	N/A
MAXM15466	8.5	42	5	1 x 1μF 0805 50V (Murata GRM21BR71H105KA12)	1 x 10μF 0805 16V (Murata GRM21BZ71C106KE15)	N/A	N/A

\* The modules have a pulse skip algorithm that allows V<sub>OUT</sub> to be regulated beyond the V<sub>IN(MAX)</sub> specified in the above table, up to 42V.

### Power Dissipation

The power dissipation inside the module leads to increase in the junction temperature of the MAXM15465/MAXM15466/MAXM15467. The power loss inside the module at full load can be estimated as follows:

$$P_{LOSS} = P_{OUT} \times \left[ \frac{1}{\eta} - 1 \right]$$

Where η is the efficiency of the power module at the desired operating conditions. The junction temperature (T<sub>J</sub>) of the module can be estimated at any given maximum ambient temperature (T<sub>A</sub>) from the following equation:

$$T_J = T_A + [\theta_{JA} \times P_{LOSS}]$$

For the MAXM15465/MAXM15466/MAXM15467 evaluation board, the thermal resistance from junction-to-ambient (θ<sub>JA</sub>) is 41.56°C/W. Operating the module at junction temperatures greater than +125°C degrades operating lifetimes. An EESIM model is available for the MAXM15465/MAXM15466/MAXM15467 to simulate efficiency and power loss for the desired operating conditions.

### PCB Layout Guidelines

Use the following guidelines for good PCB layout:

- Keep the input capacitors as close as possible to the IN and GND pins.
- Keep the output capacitors as close as possible to the OUT and GND pins.
- Keep the resistive feedback dividers as close as possible to the FB pin.
- Keep the power traces and load connections short. Refer to the EV kit layout for first-pass success.

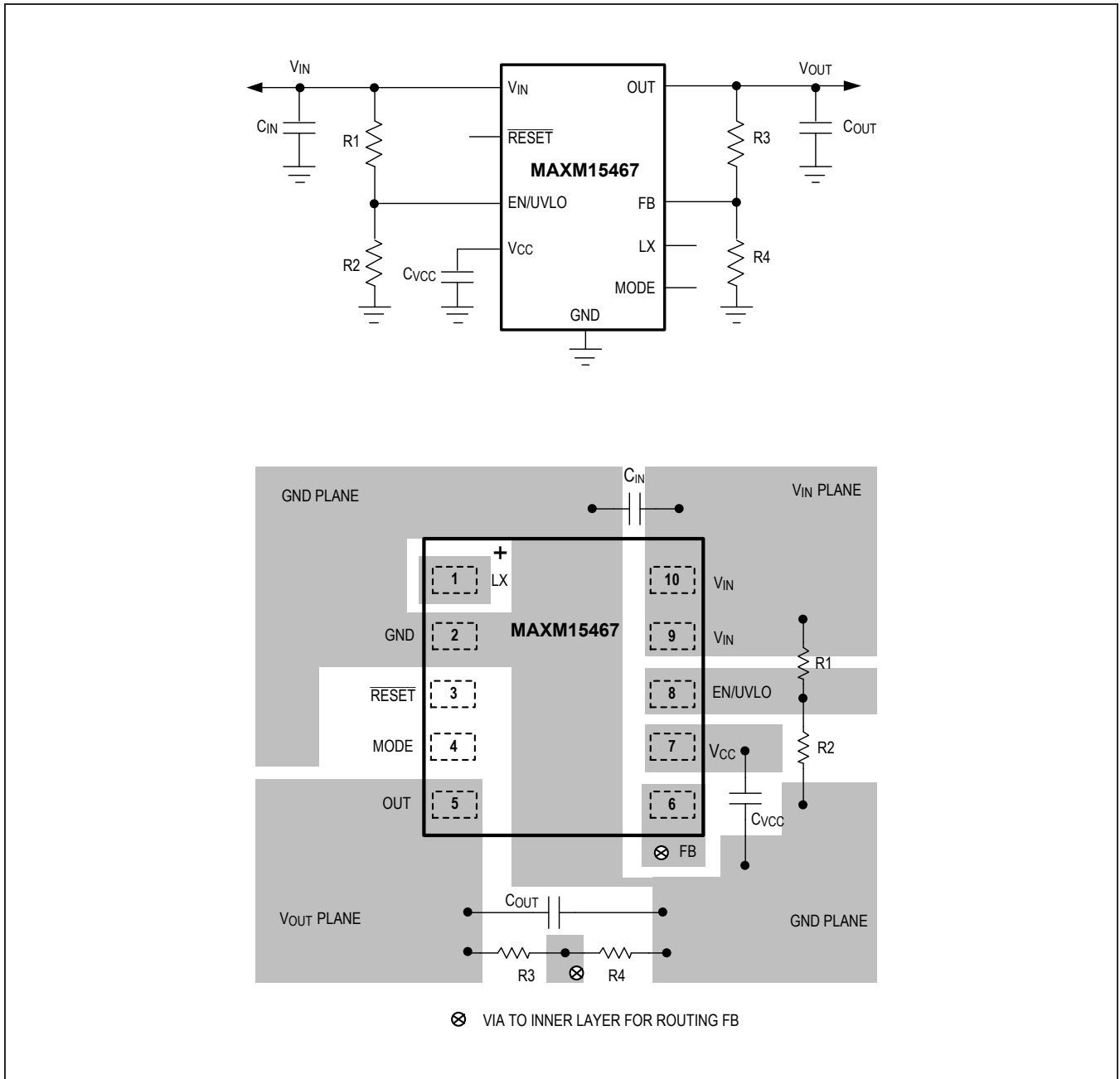

Figure 3. Adjustable Output Layout Guidelines

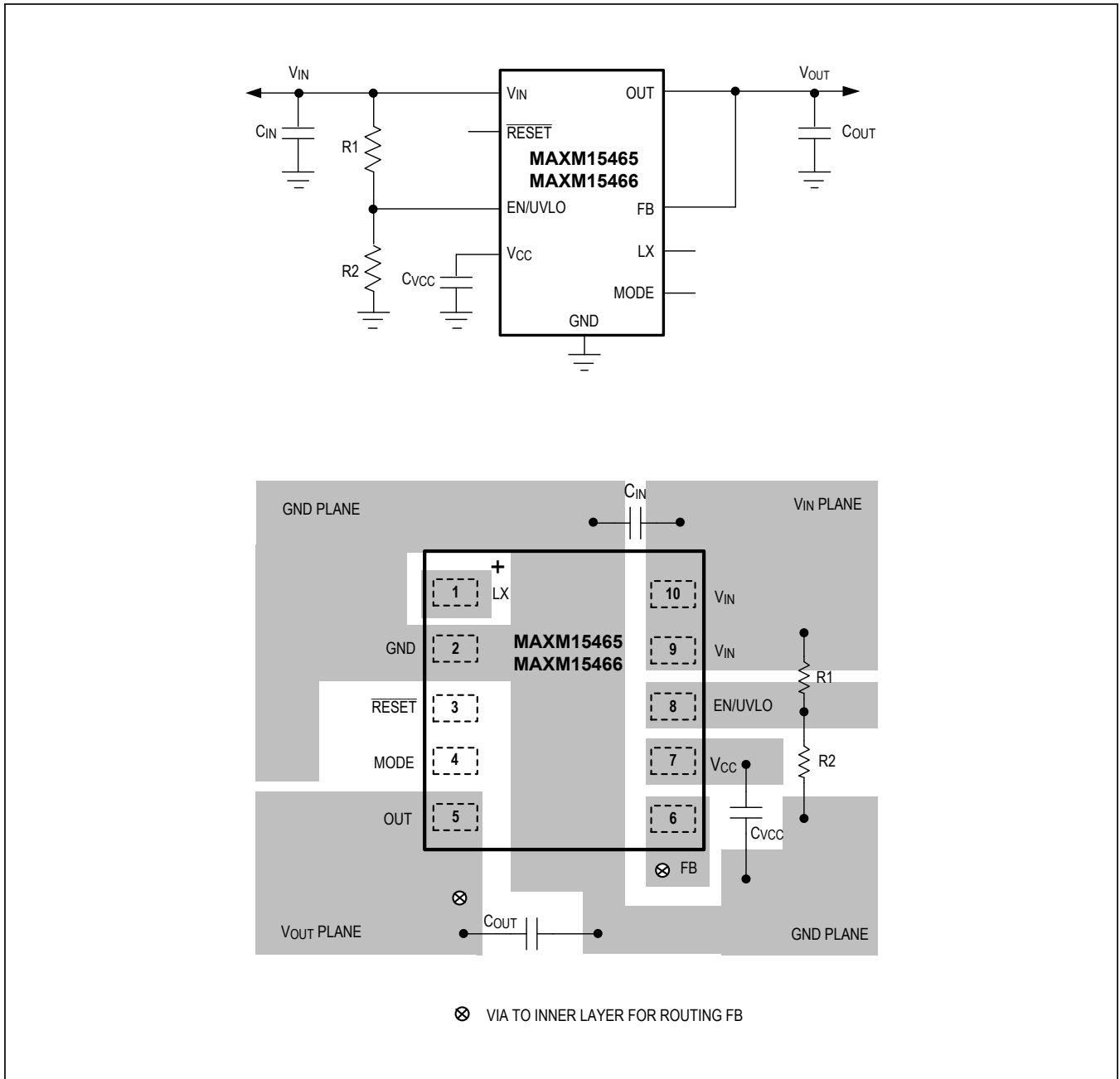
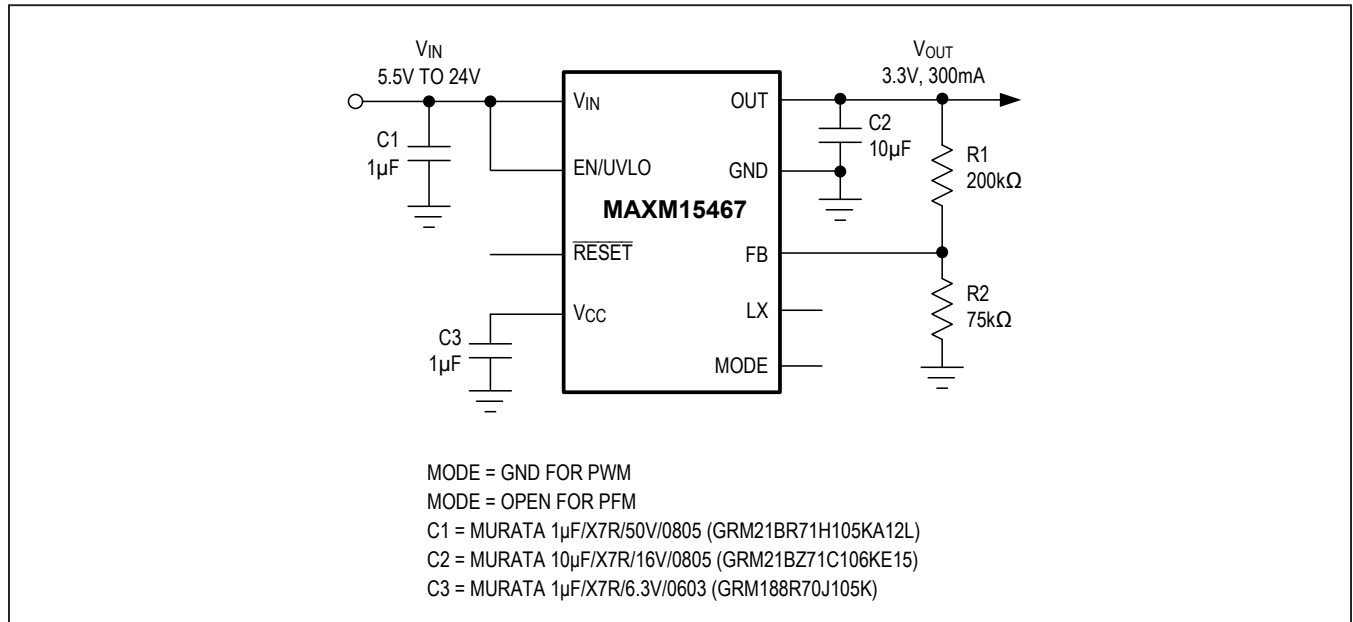

Figure 4. Fixed Output Layout Guidelines

### Typical Application Circuits

#### Typical Application Circuit for Adjustable 3.3V Output



#### Typical Application Circuit for Adjustable 2.5V Output

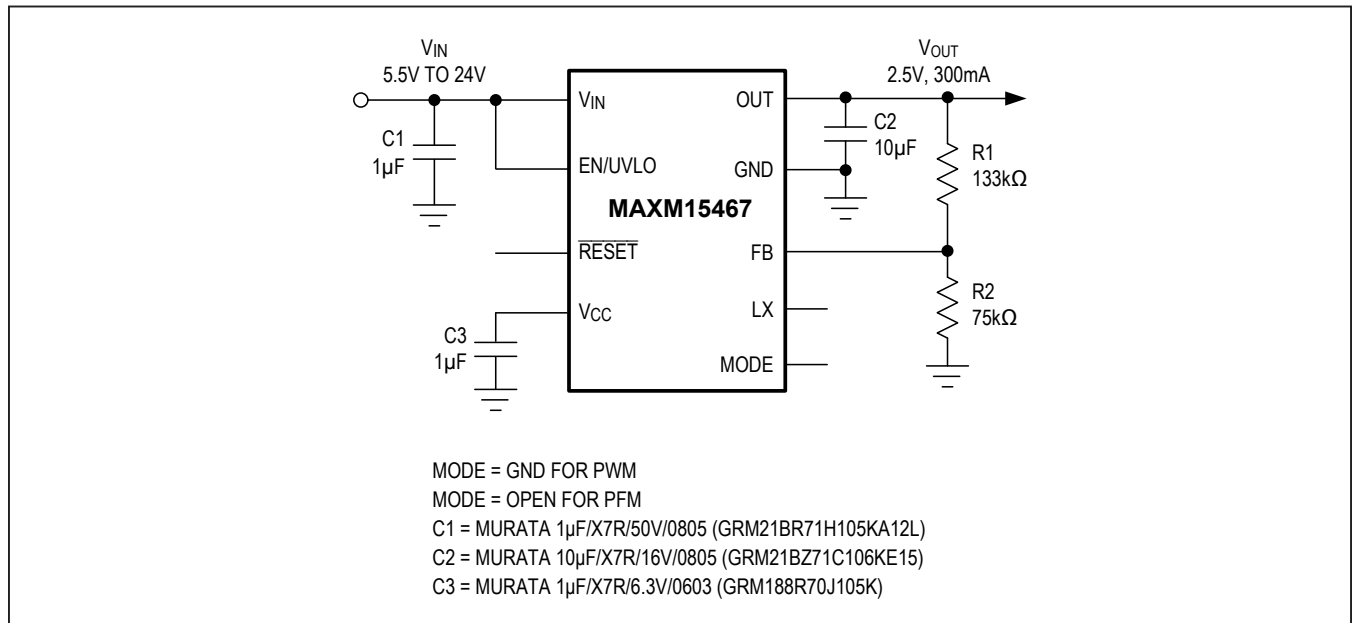

Typical Application Circuits (continued)

Typical Application Circuit for Adjustable 1.5V Output

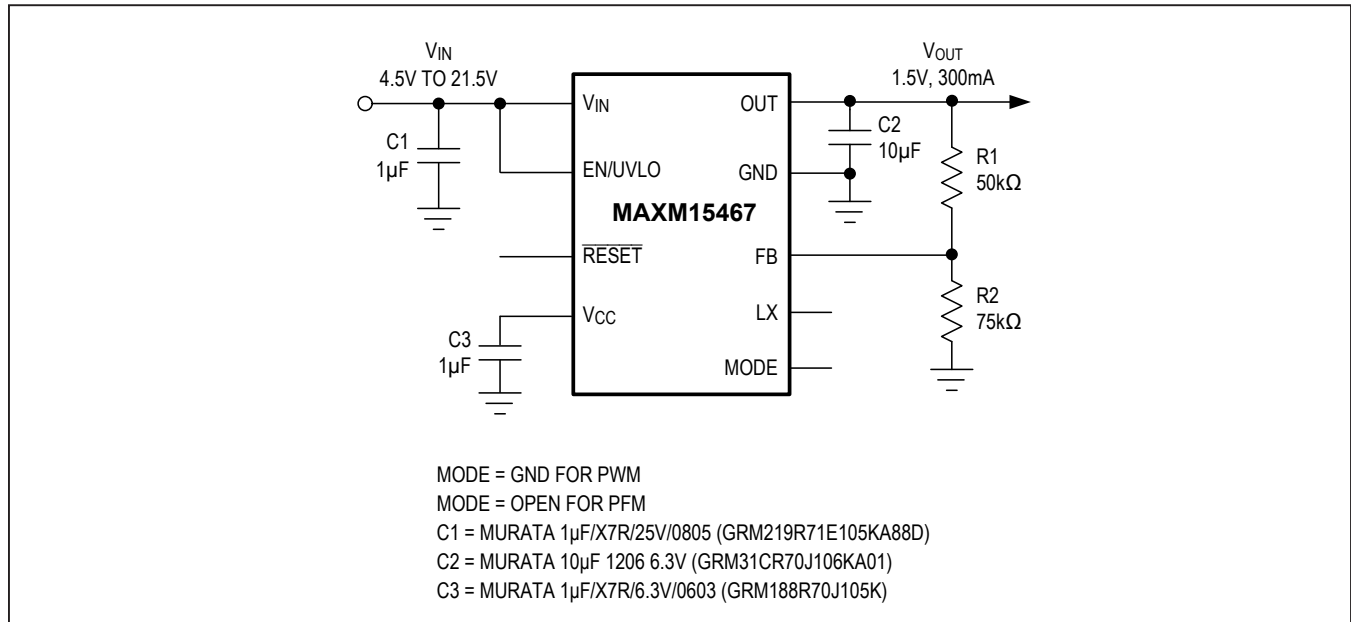

Typical Application Circuit for Fixed 3.3V Output

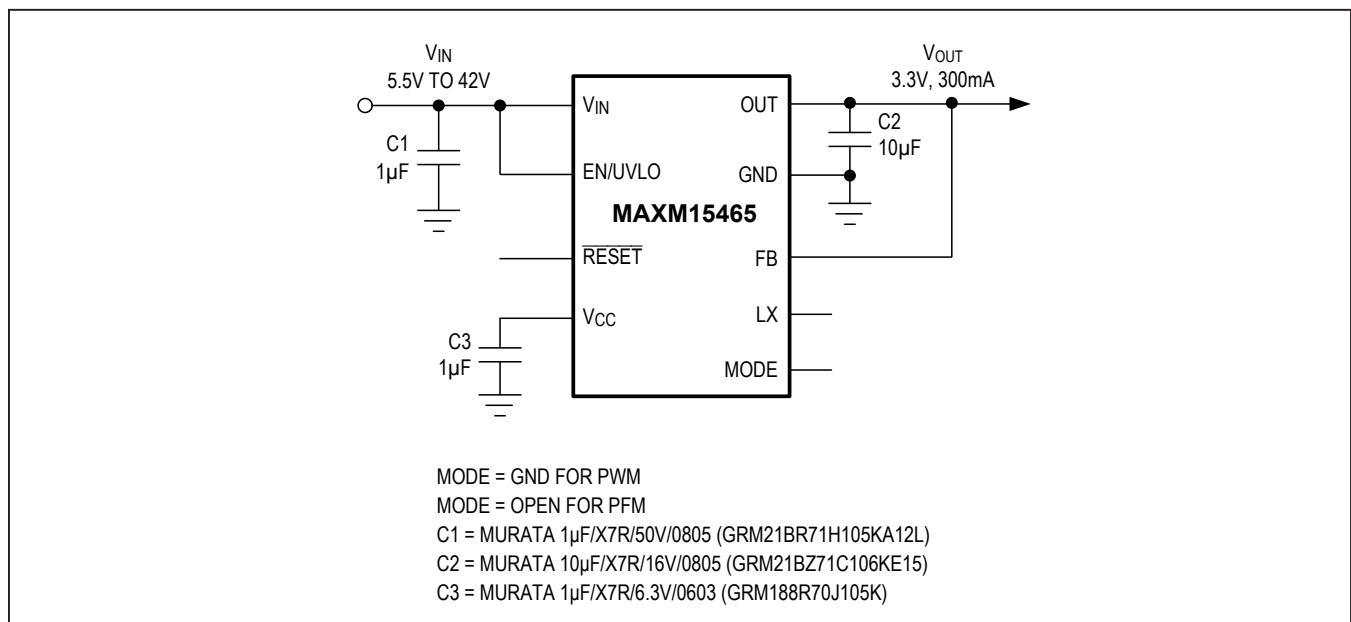



## Typical Application Circuits (continued)

### Typical Application Circuit for Fixed 5V Output

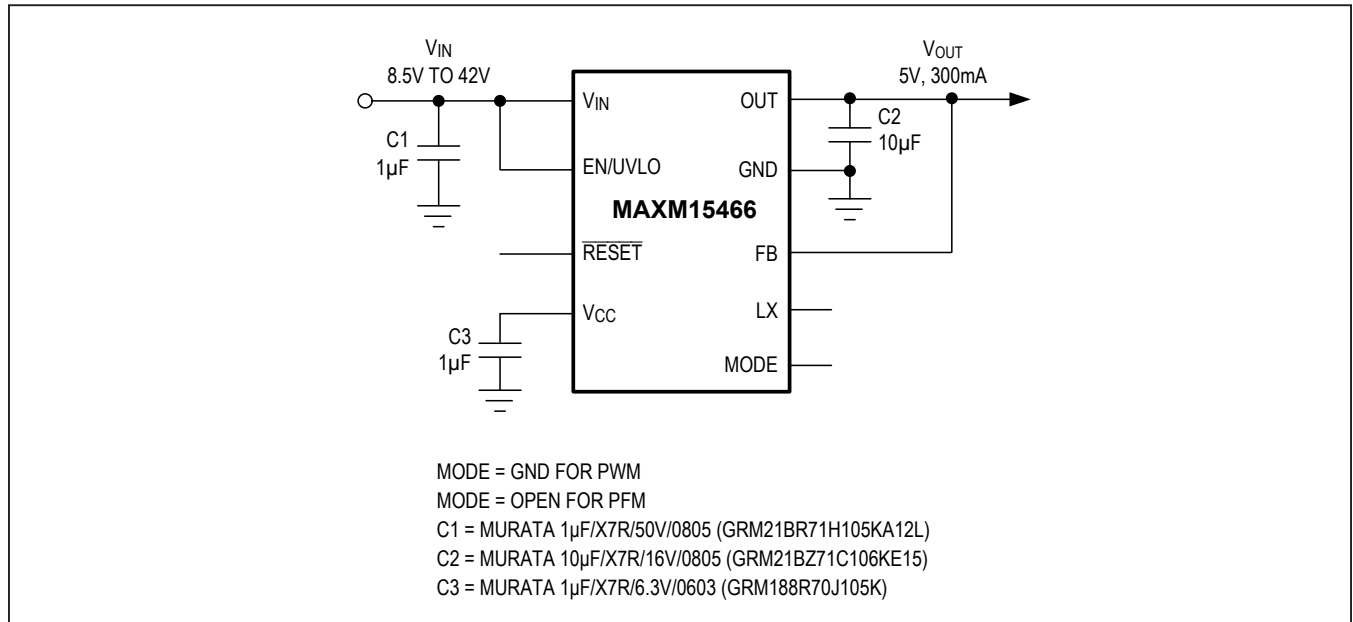

## Ordering Information

PART NUMBER	TEMP RANGE	PIN-PACKAGE
MAXM15465AMB+	-40°C to +125°C	10-pin uSLIC
MAXM15465AMB+T	-40°C to +125°C	10-pin uSLIC
MAXM15466AMB+	-40°C to +125°C	10-pin uSLIC
MAXM15466AMB+T	-40°C to +125°C	10-pin uSLIC
MAXM15467AMB+	-40°C to +125°C	10-pin uSLIC
MAXM15467AMB+T	-40°C to +125°C	10-pin uSLIC

+ Denotes a lead(Pb)-free/RoHS-compliant package.

T Denotes tape-and-reel.

MAXM15465/MAXM15466/  
MAXM15467

4.5V to 42V, 300mA Himalaya uSLIC  
Step-Down Power Module

## Revision History

REVISION NUMBER	REVISION DATE	DESCRIPTION	PAGES CHANGED
0	12/18	Initial release	—

For pricing, delivery, and ordering information, please visit Maxim Integrated's online storefront at <https://www.maximintegrated.com/en/storefront/storefront.html>.

*Maxim Integrated cannot assume responsibility for use of any circuitry other than circuitry entirely embodied in a Maxim Integrated product. No circuit patent licenses are implied. Maxim Integrated reserves the right to change the circuitry and specifications without notice at any time. The parametric values (min and max limits) shown in the Electrical Characteristics table are guaranteed. Other parametric values quoted in this data sheet are provided for guidance.*



Компания «ЭлектроПласт» предлагает заключение долгосрочных отношений при поставках импортных электронных компонентов на взаимовыгодных условиях!

Наши преимущества:

- Оперативные поставки широкого спектра электронных компонентов отечественного и импортного производства напрямую от производителей и с крупнейших мировых складов;
- Поставка более 17-ти миллионов наименований электронных компонентов;
- Поставка сложных, дефицитных, либо снятых с производства позиций;
- Оперативные сроки поставки под заказ (от 5 рабочих дней);
- Экспресс доставка в любую точку России;
- Техническая поддержка проекта, помощь в подборе аналогов, поставка прототипов;
- Система менеджмента качества сертифицирована по Международному стандарту ISO 9001;
- Лицензия ФСБ на осуществление работ с использованием сведений, составляющих государственную тайну;
- Поставка специализированных компонентов (Xilinx, Altera, Analog Devices, Intersil, Interpoint, Microsemi, Aeroflex, Peregrine, Syfer, Eurofarad, Texas Instrument, Miteq, Cobham, E2V, MA-COM, Hittite, Mini-Circuits, General Dynamics и др.);

Помимо этого, одним из направлений компании «ЭлектроПласт» является направление «Источники питания». Мы предлагаем Вам помощь Конструкторского отдела:

- Подбор оптимального решения, техническое обоснование при выборе компонента;
- Подбор аналогов;
- Консультации по применению компонента;
- Поставка образцов и прототипов;
- Техническая поддержка проекта;
- Защита от снятия компонента с производства.



#### Как с нами связаться

**Телефон:** 8 (812) 309 58 32 (многоканальный)

**Факс:** 8 (812) 320-02-42

**Электронная почта:** [org@eplast1.ru](mailto:org@eplast1.ru)

**Адрес:** 198099, г. Санкт-Петербург, ул. Калинина, дом 2, корпус 4, литера А.