

ZM Series Subminiature Snap-acting Switches

Features/Benefits

- **Reliable snap-acting mechanism**
- **Long electrical and mechanical life**
- **Compact size—Ideal when space is limited**
- **Various PCB terminals and actuators**
- **RoHS compliant / compatible**

Typical Applications

- **PCB detection switch**
- **Communication devices**
- **Testing equipment**
- **Security/Alarm systems**
- **Consumer electronics**

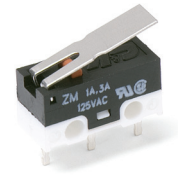

UL61058-1  

Specifications

CONTACT RATING: F7: 3A @ 125 VAC
M9: 0.2A @ 60 VDC.
ELECTRICAL LIFE: 10,000 Cycles. @ 3A
INSULATION RESISTANCE: 100 M ohm min.
DIELECTRIC STRENGTH: 1000 Vrms.
OPERATING TEMPERATURE: -30°C to 85°C.
OPERATING FORCE: CJ: 150 grams, CH: 90 grams.

* Low Level=conditions where no arcing occurs during switching, i.e., 0.4 VA max. @ 20 V AC or DC max.

Materials



COVER: Nylon 6/6
ACTUATOR BUTTON: Nylon 6/6
CASE: Nylon 6/6
SPRING: SUS
MOVABLE BLADE: BeCu
MOVABLE CONTACT: Silver alloy (M9 option gold plated)
FIXED CONTACTS: Silver alloy (M9 option gold plated)
FIXED TERMINALS: Brass - Ag plated.
ACTUATOR (Leaf / Roller options): SUS

NOTE: Specifications and materials listed above are for switches with standard options. For information on specific and custom switches, consult Customer Service Center.

Build-A-Switch

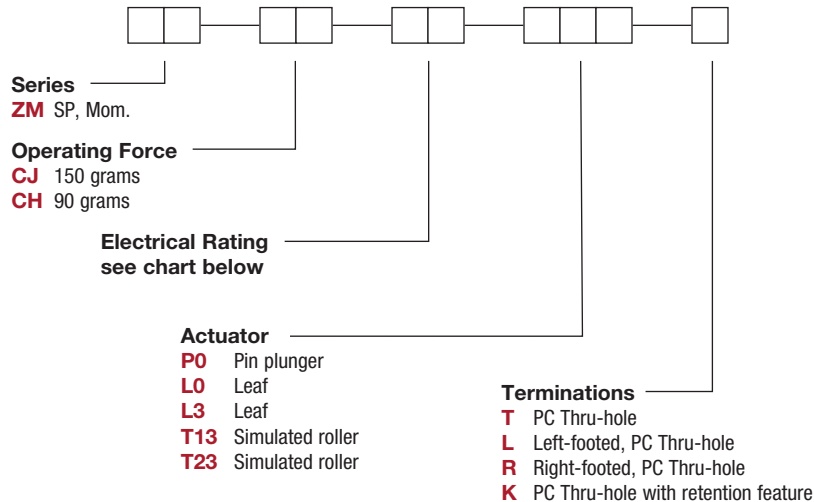
To order, simply select desired option from each category and place in the appropriate box. Available options are shown and described on pages J-48 and J-49. For additional options not shown in catalog, consult Customer Service Center.



| Option Code |  1054 |  61058-1 |  |
|-------------|--|---|---|
| F7 | 3 A 125 V AC | 3 A 125 V AC 3 A 30 V DC | 3 A 125 V AC |
| M9 | 0.1 A 48 V DC 0.2 A 60 V DC 0.1 A 125 V AC | 0.1 A 48 V DC 0.2 A 60 V DC 0.1 A 125 V AC | 0.1 A 48 V DC 0.2 A 60 V DC 0.1 A 125 V AC |

ZM Series Subminiature Snap-acting Switches

SERIES **Z M** ■ ■ ■ ■ ■ ■ ■ ■

ZM SUBMINIATURE SNAP-ACTING SWITCHES – SP MOMENTARY

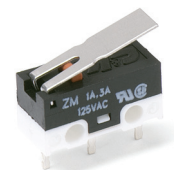
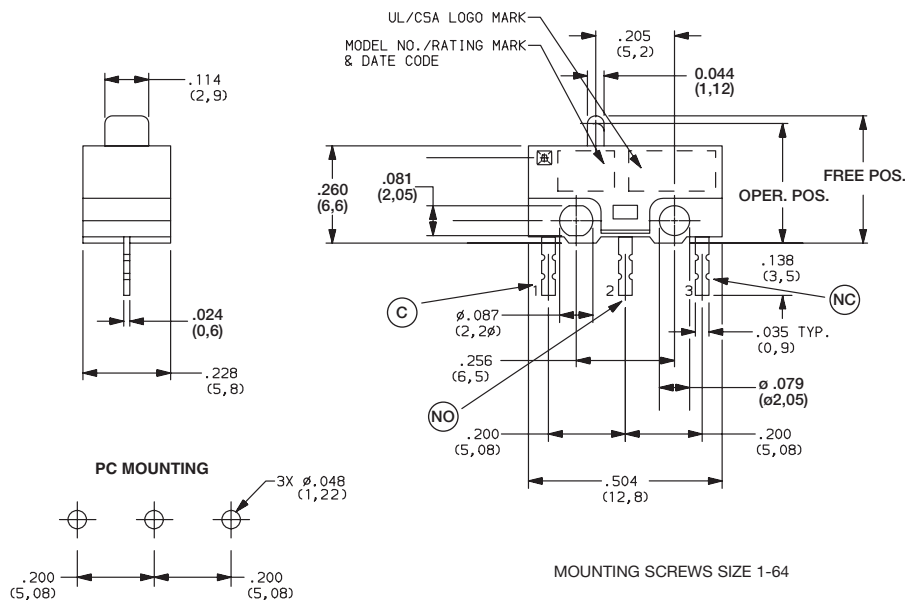

ZMCJF7L0T
SPDT

Snap-acting

OPERATING FORCE ■ ■ ■ ■ ■ ■ ■ ■

| OPTION CODE | BASIC SWITCH OPERATING FORCE (OZ./GRAMS) |
|-------------|--|
| CJ | 5.29 150 |
| CH | 3.15 90 |

ELECTRICAL RATING ■ ■ ■ ■ ■ ■ ■ ■

| OPTION CODE | RoHS COMPLIANT* | RoHS COMPATIBLE* | CONTACT MATERIAL | | ELECTRICAL RATING |
|-------------|-----------------|------------------|------------------------------|--------------------|-------------------|
| | | | MOVABLE CONTACT | STATIONARY CONTACT | |
| F7 | Yes | Yes | Silver alloy | | see chart |
| M9 | Yes | Yes | Gold plating or silver alloy | | see chart |

* Note: See Technical Data section of this catalog for RoHS compliant and compatible definition and specifications.

All models with all options.

Consult Customer Service center for availability and delivery of nonstandard ratings.

| Option Code | US 1054 | US 61058-1 | 4 |
|-------------|--|--|--|
| F7 | 3 A 125 V AC | 3 A 125 V AC 3 A 30 V DC | 3 A 125 V AC |
| M9 | 0.1 A 48 V DC 0.2 A 60 V DC 0.1 A 125 V AC | 0.1 A 48 V DC 0.2 A 60 V DC 0.1 A 125 V AC | 0.1 A 48 V DC 0.2 A 60 V DC 0.1 A 125 V AC |



Third Angle Projection

Dimensions are shown: Inch (mm)
Specifications and dimensions subject to change



ZM Series Subminiature Snap-acting Switches

ACTUATOR

P0 PIN PLUNGER

L0 LEAF, 50 GRAMS (CJ ONLY)
L3 LEAF, 30 GRAMS (CH ONLY)

T13 SIMULATED ROLLER, 40 GRAMS (CJ ONLY)
T23 SIMULATED ROLLER, 25 GRAMS (CH ONLY)

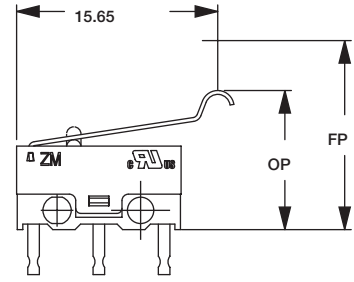
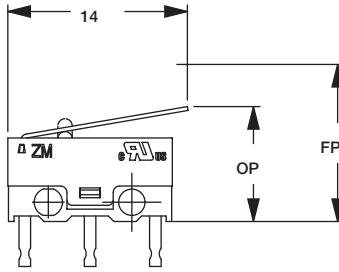
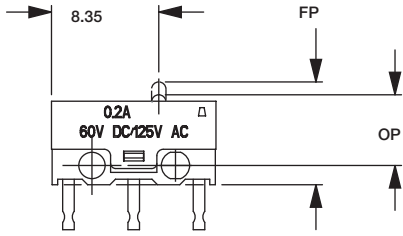

| ACTUATOR OPTION CODE | A (mm) | B Ref (mm) | C (mm) | D (mm) | E (mm) | DIFF. MOTION mm MAX | OPER. FORCE grams MAX | | RELEASED FORCE Grams MAX | OVER TRAVEL MIN |
|-------------------------|-----------------------|---------------------------------------|-----------------------|-----------------------|-------------------------|------------------------------|--------------------------------|----|-----------------------------------|-----------------------|
| | LENGTH OF LEVER | LEVER LENGTH MTG. HOLE TO OP | PRE- TRAVEL MAX | OPERATING POSITION | FREE POSITION MAX | | CJ | CH | | |
| P0 PIN PLUNGER | NA | NA | 1.3 | 7.0 ±0.3 | 8.0 | 0.3 | 150 | 90 | 15-20 | 0.2 |
| L0 LEAF | 13.0 | 4.03 | 3.4 | 8.4 ±0.8 | 11.0 | 1.3 | 50 | - | 8 | 0.6 |
| L3 LEAF | 13.0 | 4.03 | 3.4 | 8.4 ±0.8 | 11.0 | 1.3 | - | 30 | 5 | 0.6 |
| T13 SIMULATED ROLLER | 15.0 | 5.36 | 3.8 | 10.5 ±0.8 | 13.0 | 1.5 | 40 | - | 7 | 0.6 |
| T23 SIMULATED ROLLER | 15.0 | 5.36 | 3.8 | 10.5 ±0.8 | 13.0 | 1.5 | - | 25 | 4 | 0.6 |

TERMINATIONS

T (STD.) PC THRU-HOLE

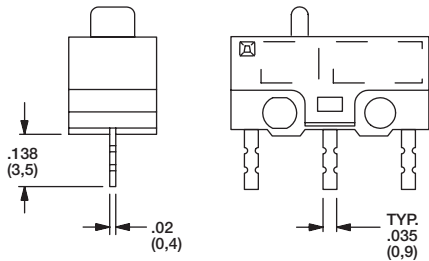

K PC THRU-HOLE WITH RETENTION FEATURE

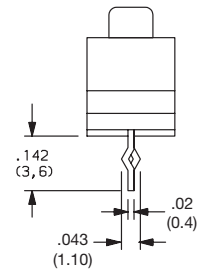

L LEFT FOOTED, PC THRU-HOLE

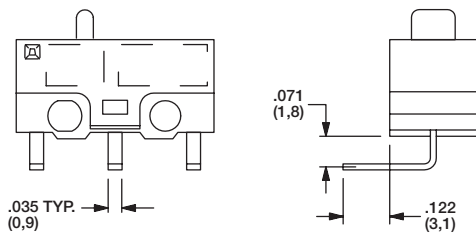

R RIGHT FOOTED, PC THRU-HOLE

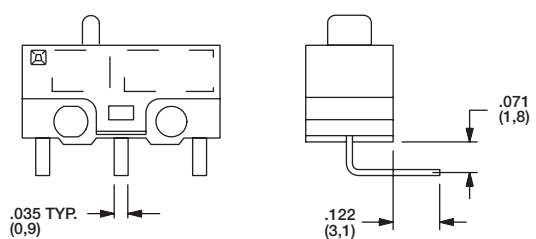

Third Angle
Projection

Dimensions are shown: Inches (mm)
Specifications and dimensions subject to change



Компания «ЭлектроПласт» предлагает заключение долгосрочных отношений при поставках импортных электронных компонентов на взаимовыгодных условиях!

Наши преимущества:

- Оперативные поставки широкого спектра электронных компонентов отечественного и импортного производства напрямую от производителей и с крупнейших мировых складов;
- Поставка более 17-ти миллионов наименований электронных компонентов;
- Поставка сложных, дефицитных, либо снятых с производства позиций;
- Оперативные сроки поставки под заказ (от 5 рабочих дней);
- Экспресс доставка в любую точку России;
- Техническая поддержка проекта, помощь в подборе аналогов, поставка прототипов;
- Система менеджмента качества сертифицирована по Международному стандарту ISO 9001;
- Лицензия ФСБ на осуществление работ с использованием сведений, составляющих государственную тайну;
- Поставка специализированных компонентов (Xilinx, Altera, Analog Devices, Intersil, Interpoint, Microsemi, Aeroflex, Peregrine, Syfer, Eurofarad, Texas Instrument, Miteq, Cobham, E2V, MA-COM, Hittite, Mini-Circuits, General Dynamics и др.);

Помимо этого, одним из направлений компании «ЭлектроПласт» является направление «Источники питания». Мы предлагаем Вам помощь Конструкторского отдела:

- Подбор оптимального решения, техническое обоснование при выборе компонента;
- Подбор аналогов;
- Консультации по применению компонента;
- Поставка образцов и прототипов;
- Техническая поддержка проекта;
- Защита от снятия компонента с производства.



Как с нами связаться

Телефон: 8 (812) 309 58 32 (многоканальный)

Факс: 8 (812) 320-02-42

Электронная почта: org@eplast1.ru

Адрес: 198099, г. Санкт-Петербург, ул. Калинина, дом 2, корпус 4, литера А.