

Proximity and ambient light sensing (ALS) module

Datasheet - production data

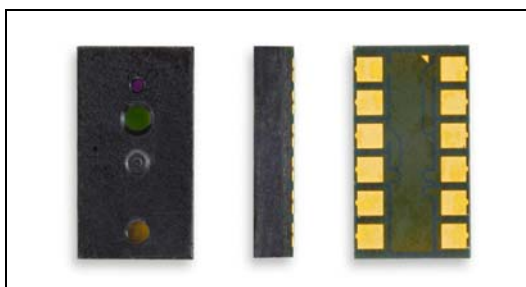

Features

- Three-in-one smart optical module
 - Proximity sensor
 - Ambient Light Sensor
 - VCSEL light source
- Fast, accurate distance ranging
 - Measures absolute range from 0 to above 10 cm (ranging beyond 10cm is dependent on conditions)
 - Independent of object reflectance
 - Ambient light rejection
 - Cross-talk compensation for cover glass
- Gesture recognition
 - Distance and signal level can be used by host system to implement gesture recognition
 - Demo system available: P-NUCLEO-6180X1 evaluation board
- Ambient light sensor
 - High dynamic range
 - Accurate/sensitive in ultra-low light
 - Calibrated output value in lux
- Easy integration
 - Single reflowable component
 - No additional optics
 - Single power supply
 - I²C interface for device control and data
 - Provided with a documented C portable API (Application Programming Interface)

- Two programmable GPIO
 - Window and thresholding functions for both ranging and ALS

Applications

- Smartphones/portable touchscreen devices
- Tablet/laptop/gaming devices
- Domestic appliances/industrial devices

Description

The VL6180X is the latest product based on ST's patented **FlightSense™** technology. This is a ground-breaking technology allowing absolute distance to be measured independent of target reflectance. Instead of estimating the distance by measuring the amount of light reflected back from the object (which is significantly influenced by color and surface), the VL6180X precisely measures the time the light takes to travel to the nearest object and reflect back to the sensor (Time-of-Flight).

Combining an IR emitter, a range sensor and an ambient light sensor in a three-in-one ready-to-use reflowable package, the VL6180X is easy to integrate and saves the end-product maker long and costly optical and mechanical design optimizations.

The module is designed for low power operation. Ranging and ALS measurements can be automatically performed at user defined intervals. Multiple threshold and interrupt schemes are supported to minimize host operations.

Host control and result reading is performed using an I²C interface. Optional additional functions, such as measurement ready and threshold interrupts, are provided by two programmable GPIO pins.

Contents

- 1 Overview 8**
 - 1.1 Technical specification 8
 - 1.2 System block diagram 9
 - 1.3 Device pinout 9
 - 1.4 Typical application schematic 10
 - 1.5 Recommended solder pad dimensions11
 - 1.6 Recommended reflow profile11

- 2 Functional description 12**
 - 2.1 Ranging pipe 13
 - 2.2 System state diagram 13
 - 2.3 Timing diagram 15
 - 2.4 Software overview 16
 - 2.5 Operating modes 16
 - 2.5.1 Polling mode - single shot range/ALS measurement 20
 - 2.5.2 Interrupt mode 21
 - VL6180x_RangeConfigInterrupt() or VL6180x_AlsConfigInterrupt() 22
 - Continuous mode limits 22
 - 2.5.3 Asynchronous mode - single shot range measurement 23
 - 2.5.4 Interleaved mode 24
 - 2.6 History buffer 25
 - 2.7 Range Sensor 26
 - 2.7.1 Range timing 26
 - 2.7.2 Range error codes 27
 - 2.7.3 Range checks 28
 - Early convergence estimate (ECE) 28
 - Range ignore 29
 - Signal-to-noise ratio (SNR) 29
 - 2.7.4 Manual/autoVHV calibration 30
 - 2.7.5 Wrap Around Filter 30
 - 2.7.6 Maximum ranging distance (DMAX) 30
 - 2.8 Other ranging system considerations 32
 - 2.8.1 Part-to-part range offset 32

2.8.2	Cross-talk	32
2.8.3	Offset calibration procedure	33
2.8.4	Cross-talk calibration procedure	33
2.8.5	Cross-talk limit	34
2.8.6	Cross-talk vs air gap	34
2.9	Current consumption	35
2.9.1	Ranging current consumption	35
2.9.2	Current consumption calculator	36
2.9.3	Current distribution	36
2.10	Ambient light sensor (ALS)	37
2.10.1	Field of view	37
2.10.2	Spectral response	37
2.10.3	ALS dynamic range	38
2.10.4	ALS count to lux conversion	38
2.10.5	Integration period	39
2.10.6	ALS gain selection	39
2.10.7	Scaler	39
3	Performance specification	40
3.1	Proximity ranging (0 to 100mm)	40
3.1.1	Max range vs. ambient light level	40
3.2	ALS performance	41
4	I²C control interface	42
4.1	I ² C interface - timing characteristics	45
5	Electrical characteristics	46
5.1	Absolute maximum ratings	46
5.2	Normal operating conditions	46
5.3	Electrical characteristics	47
6	Device registers	48
6.1	Register encoding formats	48
6.2	Register descriptions	51
6.2.1	IDENTIFICATION__MODEL_ID	51
6.2.2	IDENTIFICATION__MODEL_REV_MAJOR	51

6.2.3 IDENTIFICATION__MODEL_REV_MINOR 51

6.2.4 IDENTIFICATION__MODULE_REV_MAJOR 52

6.2.5 IDENTIFICATION__MODULE_REV_MINOR 52

6.2.6 IDENTIFICATION__DATE_HI 52

6.2.7 IDENTIFICATION__DATE_LO 53

6.2.8 IDENTIFICATION__TIME 53

6.2.9 SYSTEM__MODE_GPIO0 54

6.2.10 SYSTEM__MODE_GPIO1 55

6.2.11 SYSTEM__HISTORY_CTRL 56

6.2.12 SYSTEM__INTERRUPT_CONFIG_GPIO 57

6.2.13 SYSTEM__INTERRUPT_CLEAR 57

6.2.14 SYSTEM__FRESH_OUT_OF_RESET 58

6.2.15 SYSTEM__GROUPED_PARAMETER_HOLD 58

6.2.16 SYSRANGE__START 59

6.2.17 SYSRANGE__THRESH_HIGH 59

6.2.18 SYSRANGE__THRESH_LOW 60

6.2.19 SYSRANGE__INTERMEASUREMENT_PERIOD 60

6.2.20 SYSRANGE__MAX_CONVERGENCE_TIME 60

6.2.21 SYSRANGE__CROSSTALK_COMPENSATION_RATE 61

6.2.22 SYSRANGE__CROSSTALK_VALID_HEIGHT 61

6.2.23 SYSRANGE__EARLY_CONVERGENCE_ESTIMATE 61

6.2.24 SYSRANGE__PART_TO_PART_RANGE_OFFSET 62

6.2.25 SYSRANGE__RANGE_IGNORE_VALID_HEIGHT 62

6.2.26 SYSRANGE__RANGE_IGNORE_THRESHOLD 62

6.2.27 SYSRANGE__MAX_AMBIENT_LEVEL_MULT 63

6.2.28 SYSRANGE__RANGE_CHECK_ENABLES 63

6.2.29 SYSRANGE__VHV_RECALIBRATE 64

6.2.30 SYSRANGE__VHV_REPEAT_RATE 64

6.2.31 SYSALS__START 65

6.2.32 SYSALS__THRESH_HIGH 65

6.2.33 SYSALS__THRESH_LOW 66

6.2.34 SYSALS__INTERMEASUREMENT_PERIOD 66

6.2.35 SYSALS__ANALOGUE_GAIN 67

6.2.36 SYSALS__INTEGRATION_PERIOD 67

6.2.37 RESULT__RANGE_STATUS 68

6.2.38 RESULT__ALS_STATUS 69

6.2.39 RESULT__INTERRUPT_STATUS_GPIO 70

6.2.40	RESULT__ALS_VAL	70
6.2.41	RESULT__HISTORY_BUFFER_x	71
6.2.42	RESULT__RANGE_VAL	72
6.2.43	RESULT__RANGE_RAW	72
6.2.44	RESULT__RANGE_RETURN_RATE	72
6.2.45	RESULT__RANGE_REFERENCE_RATE	73
6.2.46	RESULT__RANGE_RETURN_SIGNAL_COUNT	73
6.2.47	RESULT__RANGE_REFERENCE_SIGNAL_COUNT	74
6.2.48	RESULT__RANGE_RETURN_AMB_COUNT	74
6.2.49	RESULT__RANGE_REFERENCE_AMB_COUNT	74
6.2.50	RESULT__RANGE_RETURN_CONV_TIME	75
6.2.51	RESULT__RANGE_REFERENCE_CONV_TIME	75
6.2.52	READOUT__AVERAGING_SAMPLE_PERIOD	75
6.2.53	FIRMWARE__BOOTUP	76
6.2.54	FIRMWARE__RESULT_SCALER	76
6.2.55	I2C_SLAVE__DEVICE_ADDRESS	76
6.2.56	INTERLEAVED_MODE__ENABLE	77
7	Outline drawing	78
8	Laser safety considerations	80
8.1	Compliance	80
9	Ordering information	81
9.1	Traceability and identification	81
9.2	Part marking	81
9.3	Packaging	82
9.3.1	Package labeling	82
9.4	Storage	83
9.5	ROHS compliance	83
10	ECOPACK®	84
11	Revision history	85

List of tables

Table 1.	Technical specification	8
Table 2.	VL6180X pin numbers and signal descriptions.	10
Table 3.	Recommended reflow profile	11
Table 4.	Power-up timing constraints	15
Table 5.	API supported operating modes	17
Table 6.	VL6180X range operating modes	17
Table 7.	VL6180X ALS operating modes	18
Table 8.	Non API operating modes.	19
Table 9.	Interleaved mode limits (10 Hz operation)	23
Table 10.	History buffer	25
Table 11.	Typical range convergence time (ms).	27
Table 12.	Range error codes	27
Table 13.	Typical current consumption in different operating states	35
Table 14.	Breakdown of current consumption	36
Table 15.	Current consumption on AVDD and AVDD_VCSEL.	36
Table 16.	ALS dynamic range	38
Table 17.	Actual gain values.	39
Table 18.	Ranging specification	40
Table 19.	Worst case max range vs. ambient 0 to 100mm	40
Table 20.	ALS performance	41
Table 21.	I ² C interface - timing characteristics	45
Table 22.	Absolute maximum ratings	46
Table 23.	Normal operating conditions	46
Table 24.	Digital I/O electrical characteristics	47
Table 25.	Register groups	48
Table 26.	32-bit register example	48
Table 27.	9.7 and 4.4 register formats	48
Table 28.	Register summary.	49
Table 29.	Delivery format	81
Table 30.	Storage conditions	83
Table 31.	Document revision history	85

List of figures

Figure 1.	VL6180X block diagram	9
Figure 2.	VL6180X pinout	9
Figure 3.	Root part number 1 schematic	10
Figure 4.	Recommended solder pattern	11
Figure 5.	Recommended reflow profile	11
Figure 6.	Typical ranging performance	12
Figure 7.	ALS linearity	13
Figure 8.	Ranging pipe architecture	13
Figure 9.	System state diagram	14
Figure 10.	Power-up timing	15
Figure 11.	Simple ALS routine	16
Figure 12.	Simple range routine	16
Figure 13.	Range polling mode	20
Figure 14.	ALS polling mode	20
Figure 15.	Range Interrupt mode	21
Figure 16.	ALS Interrupt mode	21
Figure 17.	Asynchronous mode	23
Figure 18.	Interleaved mode	24
Figure 19.	Interleaved mode	25
Figure 20.	Total range execution time	26
Figure 21.	Early convergence estimate (ECE)	28
Figure 22.	Wrap around - far target	30
Figure 23.	Part-to-part range offset	32
Figure 24.	Cross-talk compensation	32
Figure 25.	Cross-talk vs air gap	34
Figure 26.	Typical ranging current consumption (10 Hz sampling rate)	35
Figure 27.	VCSEL pulse duty cycle	36
Figure 28.	ALS angular response	37
Figure 29.	ALS spectral response	37
Figure 30.	Serial interface data transfer protocol	42
Figure 31.	I2C device address	42
Figure 32.	Single location, single write	42
Figure 33.	Single location, single read	43
Figure 34.	Multiple location write	43
Figure 35.	Multiple location read	44
Figure 36.	I ² C timing characteristics	45
Figure 37.	Outline drawing (page 1/2)	78
Figure 38.	Outline drawing (page 2/2)	79
Figure 39.	Class 1 laser product label	80
Figure 40.	Part marking	81
Figure 41.	Tape and reel packaging	82
Figure 42.	Package labeling	82

1 Overview

This datasheet is applicable to the final VL6180X ROM code revision.

1.1 Technical specification

Table 1. Technical specification

Feature	Detail
Package	Optical LGA12
Size	4.8 x 2.8 x 1.0 mm
Ranging	0 to 100 mm ⁽¹⁾
Ambient light sensor	< 1 Lux up to 100 kLux ⁽²⁾ 16-bit output ⁽³⁾ 8 manual gain settings
Operating voltage:	
• Functional range	2.6 to 3.0 V
• Optimum range ⁽⁴⁾	2.7 to 2.9 V
Operating temperature:	
• Functional range	-20 to 70°C
• Optimum range ⁽⁴⁾	-10 to 60°C
Typical power consumption	Hardware standby (GPIO0 = 0): < 1 μ A ⁽⁵⁾ Software standby: < 1 μ A ^(5.) ALS: 300 μ A Ranging: 1.7 mA (typical average) ⁽⁶⁾
IR emitter	850 nm
I ² C	400 kHz serial bus Address: 0x29 (7-bit)

1. Ranging beyond 100mm is dependent on target reflectance and external conditions (ambient light level, temperature, voltage)
2. When used under a cover glass with 10% transmission in the visible spectrum
3. Digital output easily converted to Lux
4. Please refer to [Table 18.: Ranging specification](#)
5. GPIO0, GPIO1, SCL and SDA are pulled up to AVDD (2.8V)
6. Assumes 10 Hz sampling rate, 17% reflective target at 50 mm

1.2 System block diagram

Figure 1. VL6180X block diagram

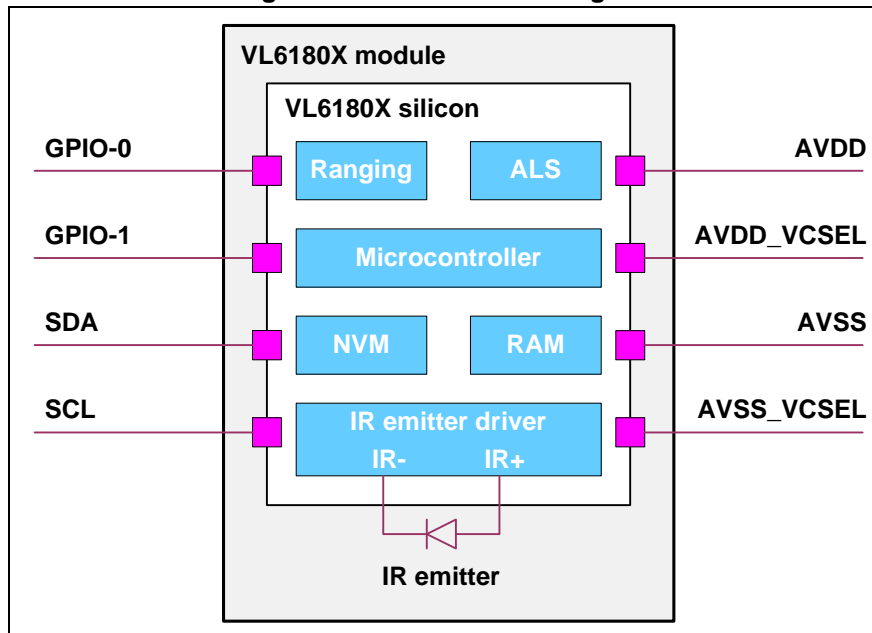

1.3 Device pinout

Figure 2 shows the pinout of the VL6180X.

Figure 2. VL6180X pinout

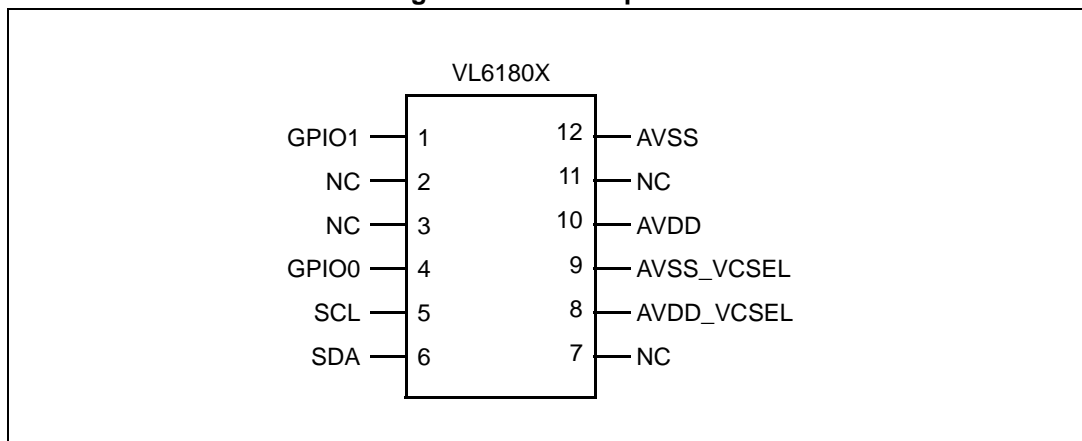

Table 2. VL6180X pin numbers and signal descriptions

Pin number	Signal name	Signal type	Signal description
1	GPIO1	Digital I/O	Interrupt output. Open-drain. If used, it should be pulled high with 47 kΩ resistor, otherwise left unconnected.
2	NC		No connect
3	NC		No connect
4	GPIO0/CE	Digital I/O	Power-up default is chip enable (CE). It should be pulled high with a 47 kΩ resistor.
5	SCL	Digital input	I ² C serial clock
6	SDA	Digital I/O	I ² C serial data
7	NC		No connect
8	AVDD_VCSEL	Supply	VCSEL power supply 2.6 to 3.0 V
9	AVSS_VCSEL	Ground	VCSEL ground
10	AVDD	Supply	Digital/analog power supply 2.6 to 3.0 V
11	NC		No connect
12	AVSS	Ground	Digital/analog ground

1.4 Typical application schematic

Figure 3 shows a typical application schematic of the VL6180X.

Figure 3. Root part number 1 schematic

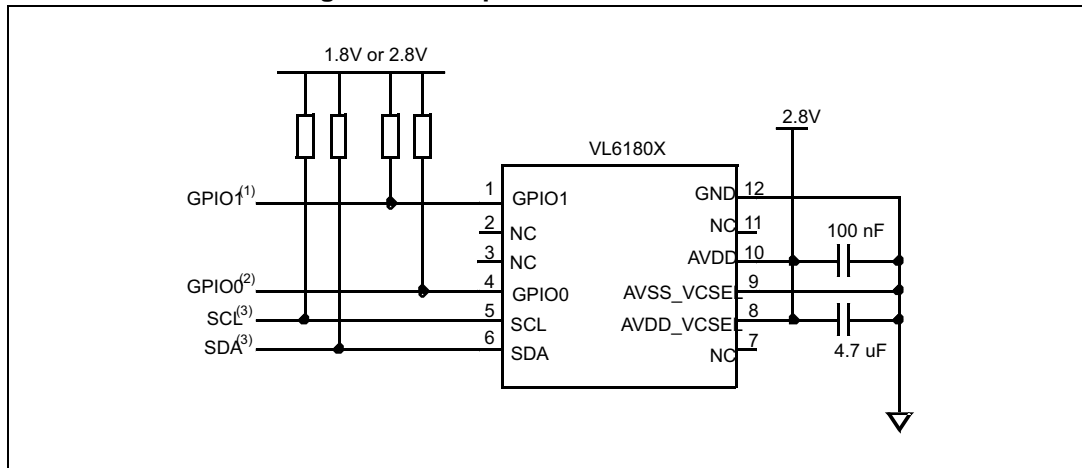

1. Open drain. If pin is used, then 47 kΩ recommended, otherwise leave floating
2. Open drain, 47 kΩ recommended
3. Open drain. Pull up resistors typically fitted once per I²C bus at host

Note: Capacitors on AVDD and AVDD_VCSEL should be placed as close as possible to the supply pads.

1.5 Recommended solder pad dimensions

Figure 4. Recommended solder pattern

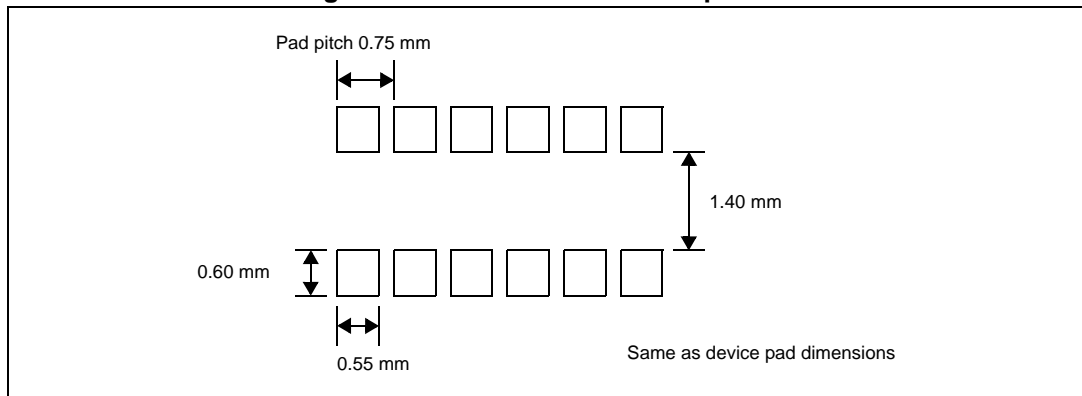

1.6 Recommended reflow profile

The recommend reflow profile is shown in [Figure 5](#) and [Table 3](#).

Figure 5. Recommended reflow profile

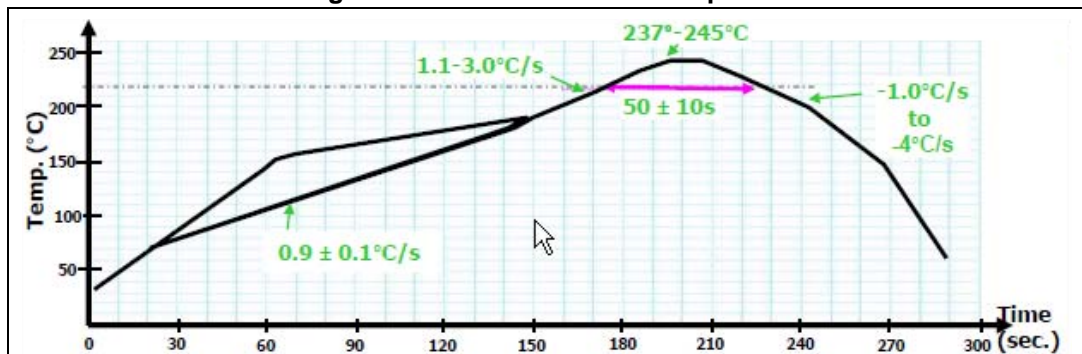

Table 3. Recommended reflow profile

Profile	Ramp to strike	
Temperature gradient in preheat	(T= 70 - 180°C):	0.9 +/- 0.1°C/s
Temperature gradient	(T= 200 - 225°C):	1.1 - 3.0°C/s
Peak temperature in reflow	237°C - 245°C	
Time above 220°C	50 +/- 10 seconds	
Temperature gradient in cooling	-1 to -4 °C/s (-6°C/s maximum)	
Time from 50 to 220°C	160 to 220 seconds	

Note: As the VL6180X package is not sealed, only a dry re-flow process should be used (such as convection re-flow). Vapor phase re-flow is not suitable for this type of optical component.

The VL6180X is an optical component and as such, it should be treated carefully. This would typically include using a 'no-wash' assembly process.

2 Functional description

This section gives an overview of the key features of the VL6180X and describes the different modes of operation of the ALS and proximity sensor.

A complete API is also associated to the device which consists of a set of C functions controlling the VL6180X to enable fast development of end-user applications. This API is structured in a way that it can be compiled on any kind of platform through a well isolated platform layer (mainly for low level I²C access). It is available for download from www.st.com.

It is assumed in the rest of the document that the host application is controlling the VL6180X device through its C API.

For a more detailed explanation of the API functions please refer to the documentation that is supplied with the API.

Typical ranging performance of the VL6180X is shown in [Figure 6](#). This demonstrates the reflectance independence and range accuracy of the VL6180X from 0 to 100 mm for 3%, 5%, 17% and 88% reflective targets. The example shown here is with ST cover glass and a 1.0 mm air gap.

[Figure 7](#) shows typical ALS linearity vs gain over a wide dynamic range. More details about the ambient light sensor can be found in [Section 2.10](#).

Figure 6. Typical ranging performance

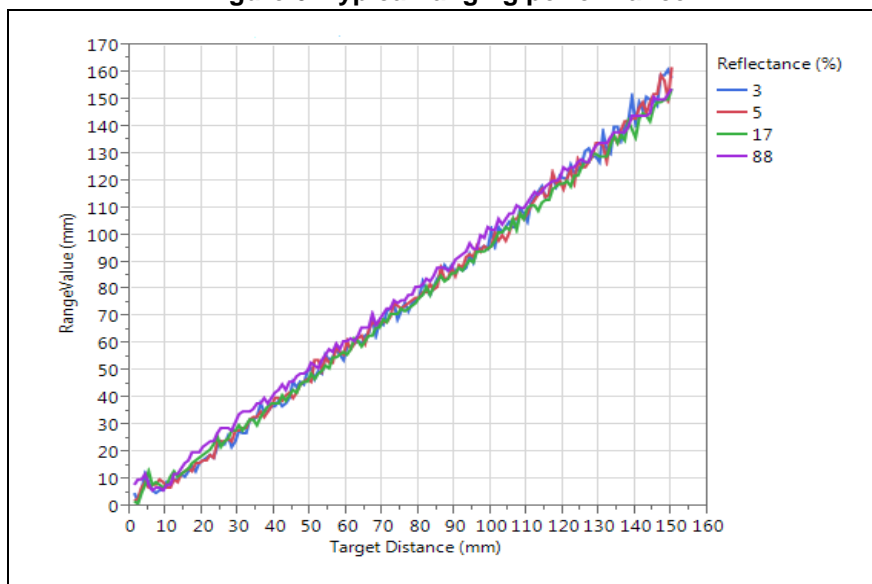
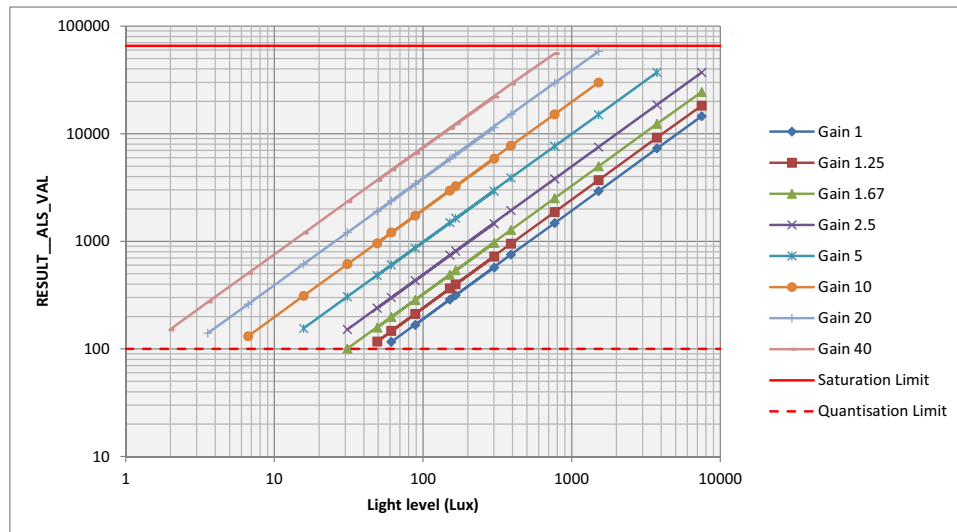

Figure 7. ALS linearity



2.1 Ranging pipe

The VL6180X uses a simple architecture to achieve range measurement.

Figure 8. Ranging pipe architecture

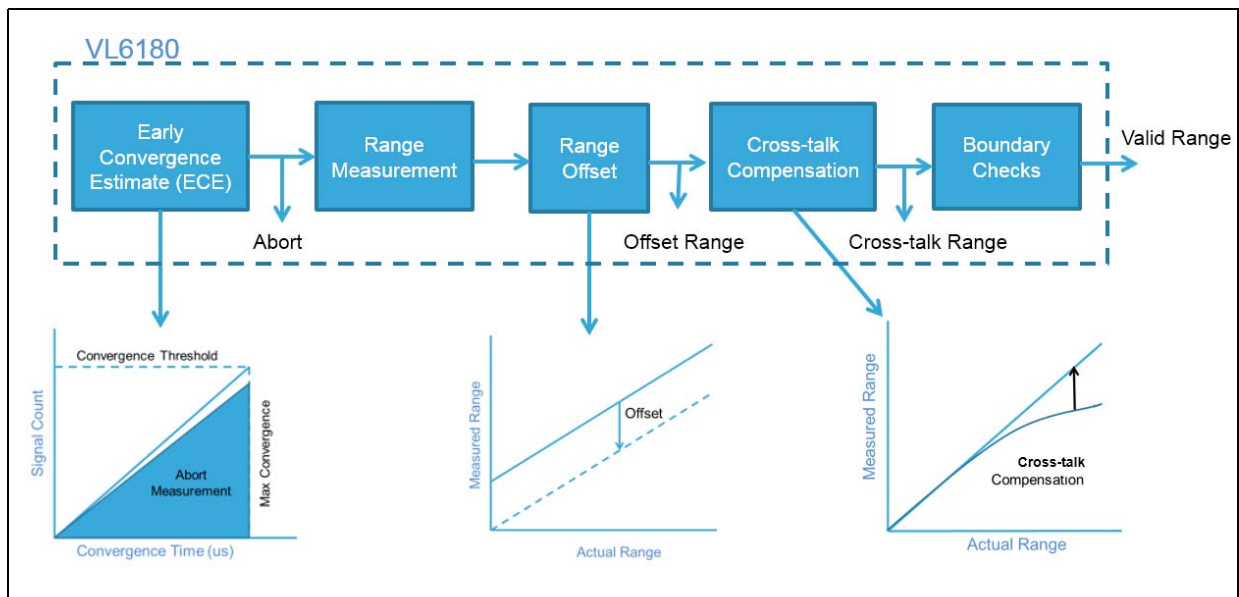

2.2 System state diagram

Figure 9 describes the main operating states of the VL6180X. Hardware standby is the reset state (GPIO0=0)^(a). The device is held in reset until GPIO0 is de-asserted. Note that the device will not respond to I²C communication in this mode. When GPIO0=1, the device enters software standby after the internal MCU boot sequence has completed.

From customer application point of view, the following sequence must be followed at the power-up stage

- Set GPIO0 to 0
- Set GPIO0 to 1
- Wait for a minimum of 400µs
- Call **VL6180x_WaitDeviceBooted()**^(b) API function (or wait for 1ms to ensure device is ready).

Then, at this stage, through API functions calls, it is possible to:

1. Configure the device to start single-shot ranging or ALS measurements.
2. Configure the device into continuous mode where the device uses an internal timer to schedule range/ALS measurements at specified intervals. See [Section 2.5.4: Interleaved mode](#).

Figure 9. System state diagram

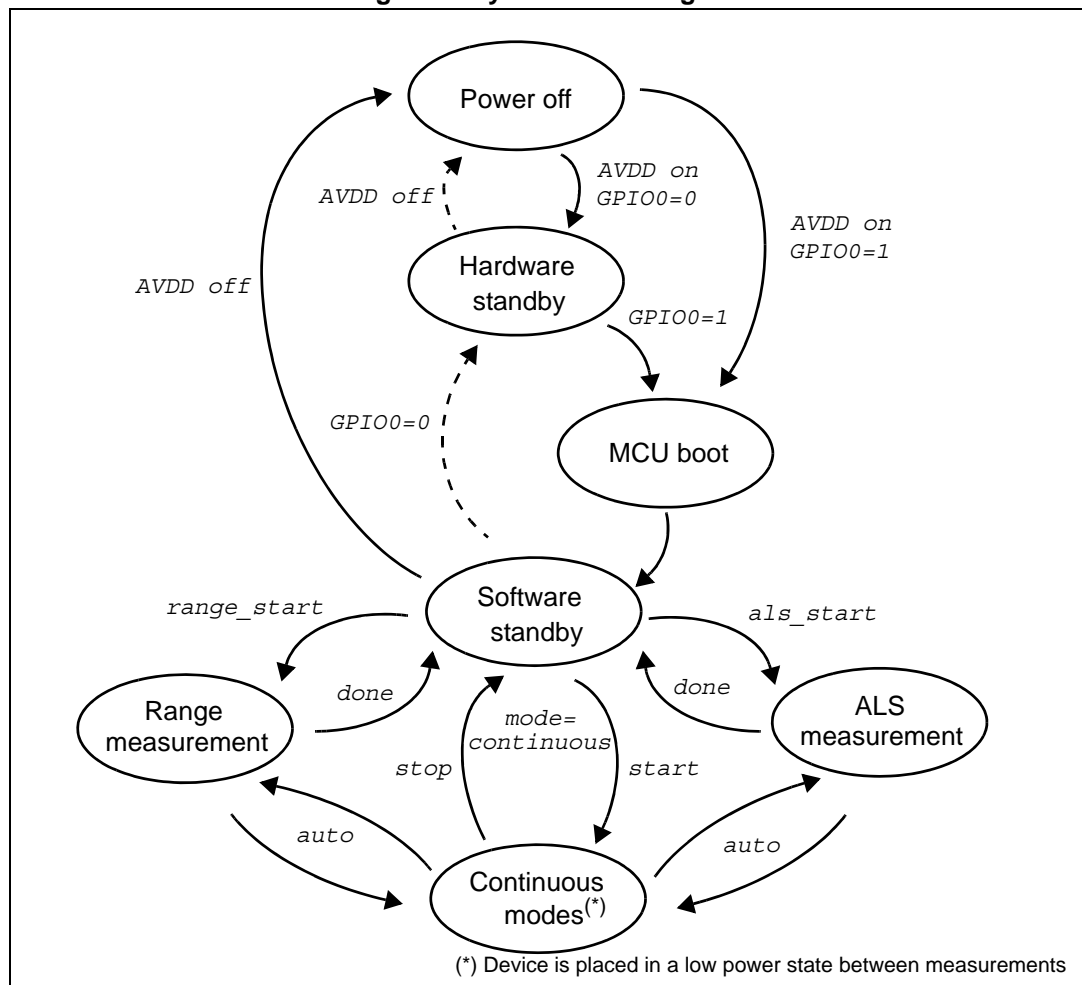

- a. Use of GPIO0 is optional
- b. Warning: The **VL6180x_WaitDeviceBooted()** function expects the device to be fresh out of reset. Calling this function when the device is not fresh out of reset will result in an infinite loop.

2.3 Timing diagram

Figure 10 and Table 4 show the Root part number 1 power-up timing constraints.

- AVDD_VCSEL must be applied before or at the same time as AVDD.
- GPIO0 defaults to an active low shutdown input. When GPIO0 = 0, the device is in hardware standby. If GPIO0 is not used it should be connected to AVDD.
- The internal microprocessor (MCU) boot sequence commences when AVDD is up and GPIO0 is high whichever is the later.
- GPIO1 power-up default is output low. It is tri-stated during the MCU boot sequence.

Note: In hardware standby, GPIO1 is output low and will sink current through any pull-up resistor. This leakage can be minimized by increasing the value of the pull-up resistor.

- After the MCU boot sequence the device enters software standby. Host initialization can commence immediately after entering software standby.

Figure 10. Power-up timing

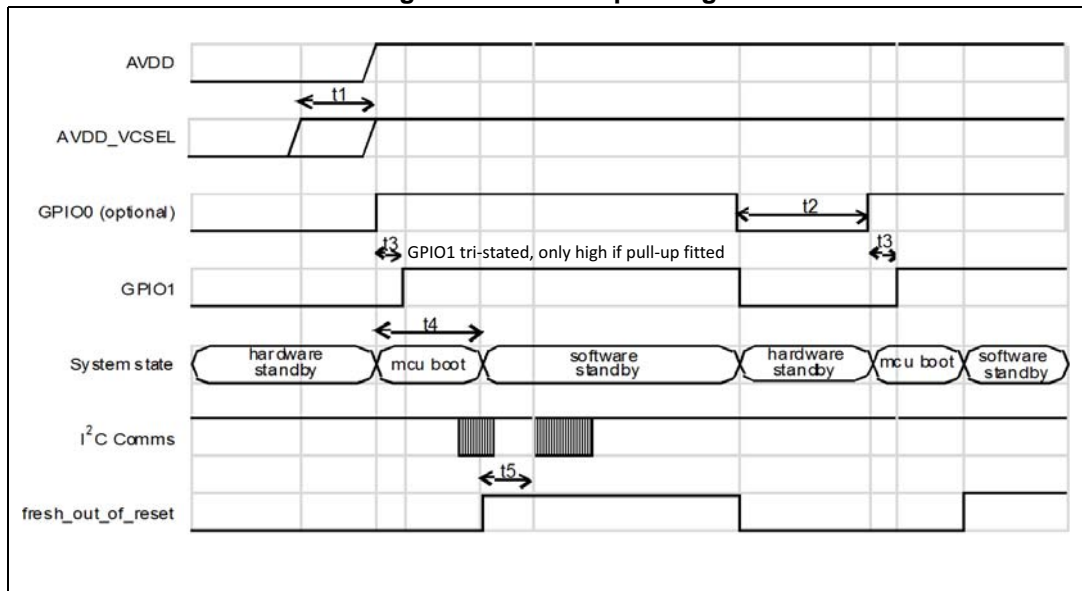

Table 4. Power-up timing constraints

Symbol	Parameter	Min	Max	Unit
t1	AVDD_VCSEL power applied after AVDD	-	0	ms
t2	Minimum reset on GPIO0	100	-	ns
t3	GPIO1 output low after hardware standby	-	400	µs
t4	MCU boot	-	1	ms
t5	Software standby to host initialization	-	0	ms

2.4 Software overview

Figure 11 shows a simple start-up routine from initialization to completing an ALS measurement while Figure 12 shows a simple start-up routine from initialization to completing a range measurement.

Figure 11. Simple ALS routine

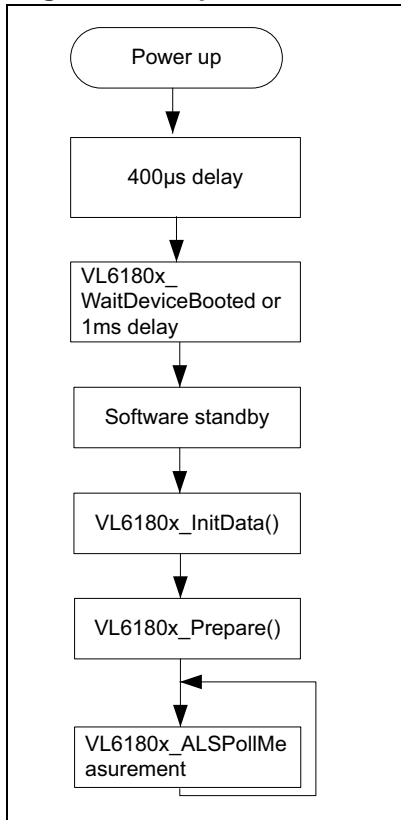
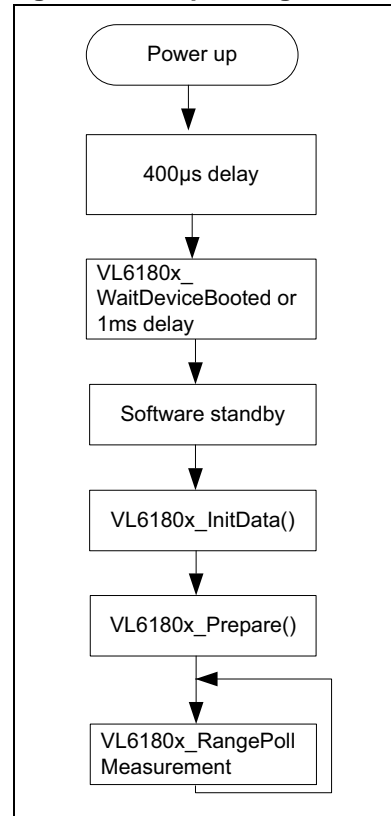

Figure 12. Simple range routine



2.5 Operating modes

The VL6180X device can operate in 2 different modes:

Single-shot measurement or Continuous measurement for both ranging and ALS.

From these 2 device modes, the VL6180X API enables 3 different typical operating range modes: Polling, interrupt or asynchronous. And 3 different ALS modes: Polling, interrupt and interleaved.

Table 5. describes the operating modes of this device supported by the API.

- Modes 1 and 2 are single-shot range and ALS measurements.
- Modes 3 and 4 are continuous range and ALS operation.
- Mode 5 allows both ALS and range measurements to be scheduled at regular intervals. The ALS measurement is completed first immediately followed by a range measurement. Interleaved mode is described in more detail in Section 2.5.4.

Table 5. API supported operating modes

Mode	Function	Range		ALS		Priority
		Single	Continuous	Single	Continuous	
1	Range single-shot	•				Range
2	ALS single-shot			•		ALS
3	Range continuous		•			Range
4	ALS continuous				•	ALS
5	Interleaved mode: Range Continuous and ALS Continuous		•		•	-

Note: Single-shot ALS and range operations cannot be performed simultaneously. Only one of these operations should be performed at any one time and once started must be allowed to complete before another measurement is started. This is because any current operation will be aborted if another is started.

Wrap Around Filter is not available in Continuous range measurement mode.

Table 6. VL6180X range operating modes

API operating mode	Description	API functions	VL6180X mode	Comments
Polling	Host requests single shot measurement and waits for the result	VL6180x_RangePollMeasurement	Single shot	Recommended for first API porting or debug
Interrupt	Ranging results are retrieved from interrupts	VL6180x_RangeSetInterMeasPeriod VL6180x_SetupGPIO1 VL6180x_RangeConfigInterrupt (VL6180x_RangeSetThreshold) VL6180x_RangeStartContinuousMode VL6180x_RangeGetMeasurement VL6180x_ClearAllInterrupt	Continuous	Recommended for User Detection applications where CPU is interrupted by VL6180X so can be asleep when no target is detected (power saving)
Asynchronous	Host requests a single shot measurement and regularly checks to see if result is ready or not	VL6180x_RangeStartSingleShot VL6180x_RangeGetMeasurement IfReady	Single shot	Recommended for AF-Assist applications, Android OS-based system where CPU is synchronized by EOF/SOF from camera or by a timer so that top application controls measurement periods

Table 7. VL6180X ALS operating modes

API operating mode	Description	API functions	VL6180X mode	Comments
Polling	Host requests single shot measurement and waits for the result	VL6180x_ALSPollMeasurement	Single shot	Recommended for first API porting or debug
Interrupt	ALS results are retrieved from interrupts	VL6180x_SetupGPIO1 VL6180x_AlsConfigInterrupt (VL6180x_AlsSetThresholds) VL6180x_AlsSetSystemMode(Mode_SingleShot) VL6180x_AlsGetMeasurement VL6180x_ClearAllInterrupt	Single shot	Recommended for AF-Assist applications, where it is used along side ranging.
Interrupt	ALS results are retrieved from interrupts	VL6180x_AlsSetInterMeasurementPeriod VL6180x_SetupGPIO1 VL6180x_AlsConfigInterrupt (VL6180x_AlsSetThresholds) VL6180x_AlsStartContinuousMode VL6180x_AlsGetMeasurement VL6180x_ClearAllInterrupt	Continuous	New ALS value available once per inter-measurement period as defined by user
Interleaved	ALS and ranging results are retrieved from interrupts	VL6180x_AlsConfigInterrupt VL6180x_AlsSetInterMeasurementPeriod VL6180x_StartInterleavedMode (calls VL6180x_AlsStartContinuousMode) VL6180x_AlsGetMeasurement VL6180x_RangeGetMeasurement VL6180x_AlsStopInterleavedMode (calls VL6180x_AlsStopContinuousMode)	Continuous	New ALS and Range values available once per inter-measurement period as defined by user. See Figure 9

Although not supported by the API, it is possible to do a mix of continuous Range and single shot ALS measurements or continuous ALS and single shot Range measurements, as shown below.

- Mode 6 is mixed continuous range and single-shot ALS operation where regular ranging measurements are required with only the occasional ALS measurement.
- Mode 7 is mixed continuous ALS and single-shot range operation where regular ALS measurements are required with only the occasional range measurement.

Table 8. Non API operating modes

Mode	Function	Range		ALS		Priority
		Single	Continuous	Single	Continuous	
6	Range continuous and ALS single-shot		•	•		ALS
7	ALS continuous and Range single-shot	•			•	Range

In modes 6 and 7, single-shot operation takes the priority i.e. if a scheduled measurement is in progress when the host requests a single-shot measurement, the scheduled measurement will be aborted and will resume on the next available time slot.

2.5.1 Polling mode - single shot range/ALS measurement

Host calls a blocking API function that requests a single shot measurement and waits for the result. CPU is blocked during this measurement request.

Figure 13. Range polling mode

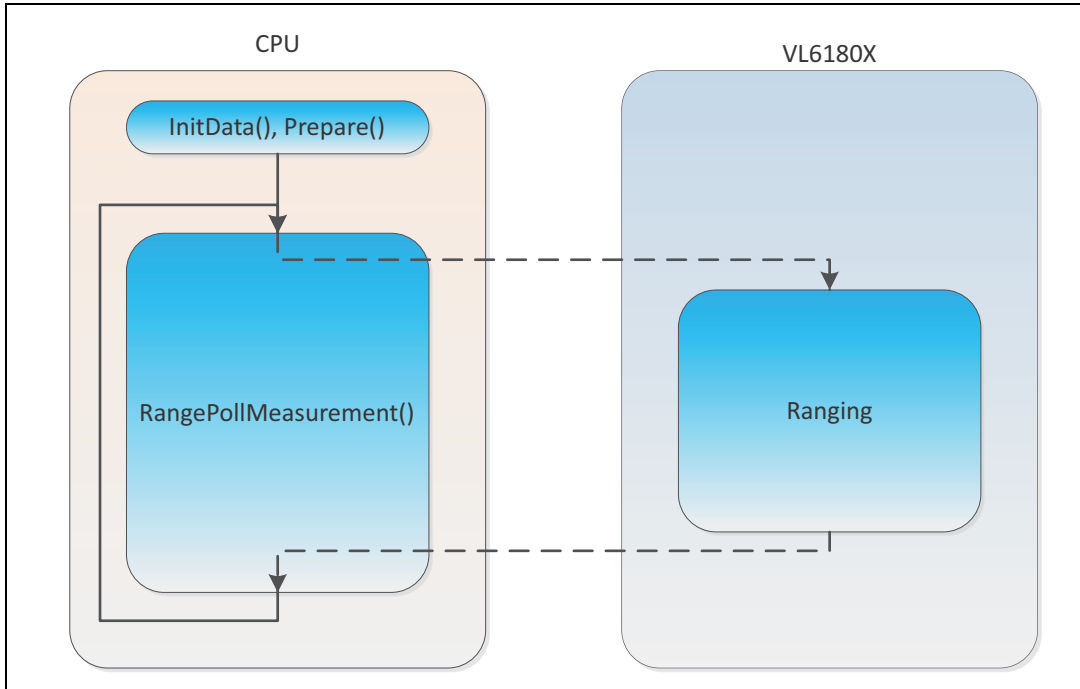
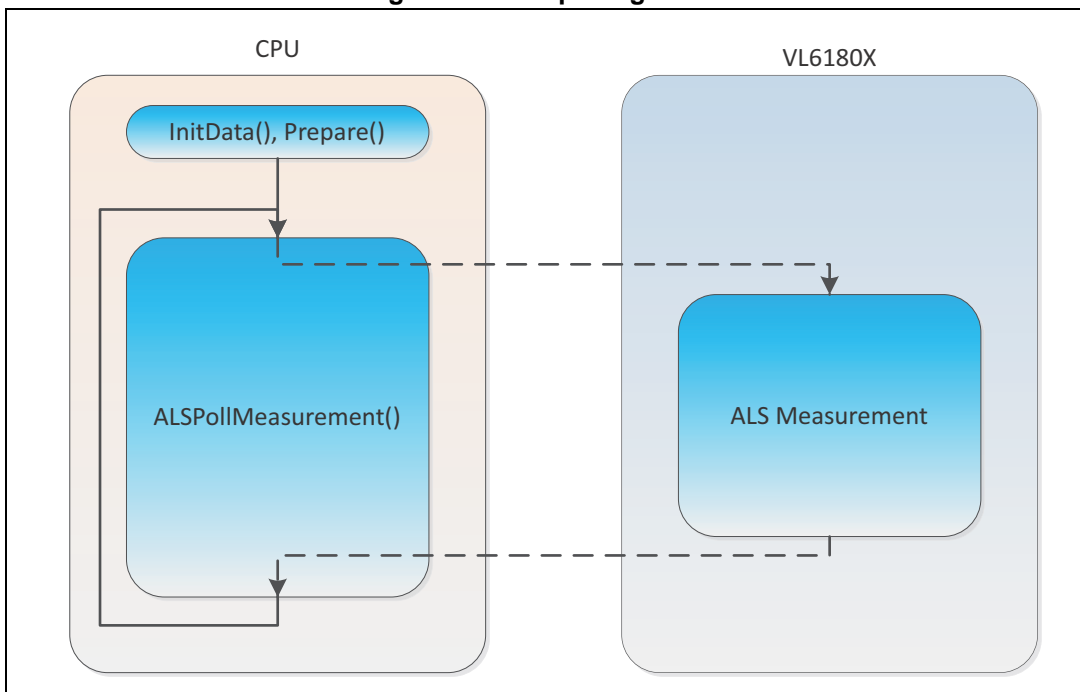

Figure 14. ALS polling mode



2.5.2 Interrupt mode

The host programs the device in continuous mode and ranging or ALS results are retrieved from interrupts.

Figure 15. Range Interrupt mode

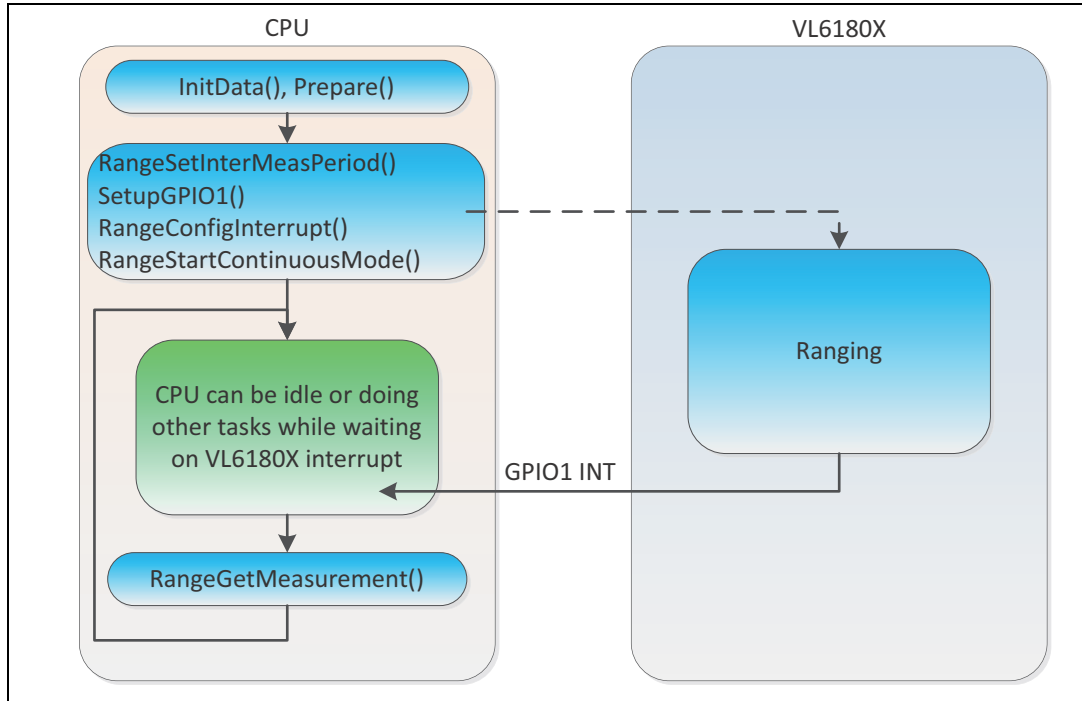
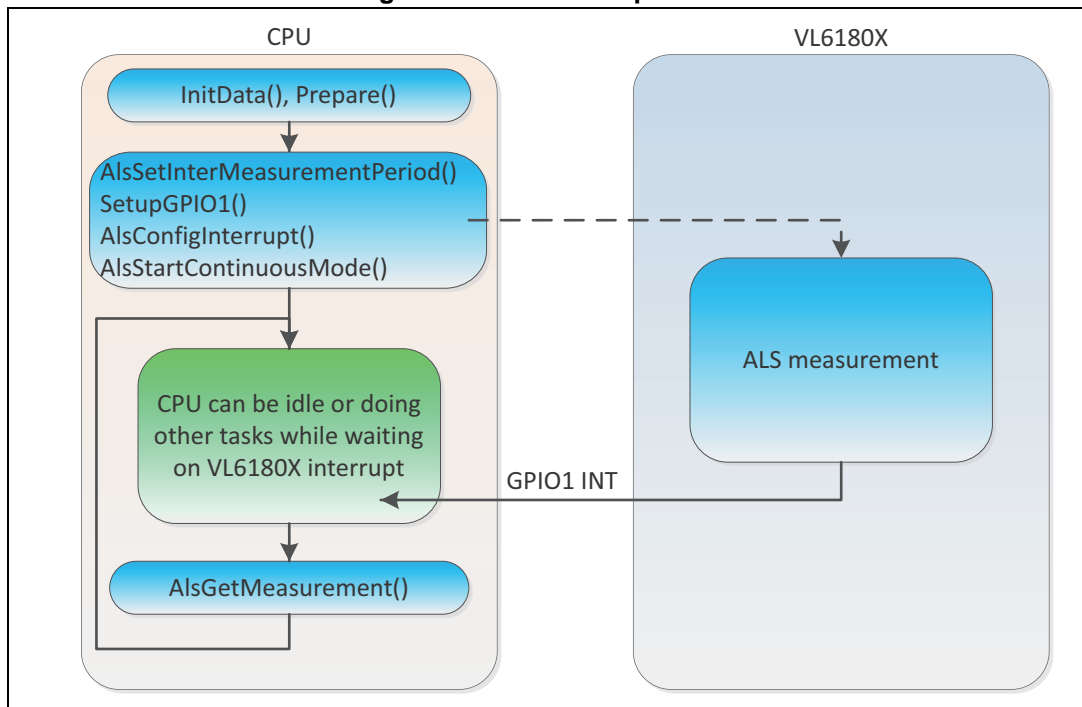

Figure 16. ALS Interrupt mode



It is not recommended to run range and ALS continuous modes simultaneously (i.e. asynchronously). Instead, mode 7 'interleaved mode' in [Table 5](#). should be used. In 'interleaved mode', scheduled range and ALS measurements operate off a single timer with a range measurement proceeding immediately after every ALS measurement.

VL6180x_RangeConfigInterrupt() or VL6180x_AlsConfigInterrupt()

The VL6180X can be configured to generate a range or ALS interrupt flag under any of the following conditions:

- New sample ready
- Level low (range/ALS value < low threshold)
- Level high (range/ALS value > high threshold)
- Out of window (range/ALS value < low threshold) OR (range/ALS value > high threshold)

In new sample ready mode (continuous mode - WAF disabled), an interrupt flag will be raised at the end of every measurement irrespective of whether the measurement is valid or if an error has occurred.

In level interrupt mode the system will raise an interrupt flag if either a low or high programmable threshold has been crossed.

Out of window interrupt mode activates both high and low level thresholds allowing a window of operation to be specified.

Range interrupt modes are selected via **VL6180x_RangeConfigInterrupt()** with **VL6180x_RangeSetThresholds()** used to set thresholds. Use **VL6180x_RangeGetInterruptStatus()** to return the ranging interrupt status.

ALS interrupt modes are selected via **VL6180x_AlsConfigInterrupt()** with **VL6180x_AlsSetThresholds()** used to set thresholds. Use **VL6180x_AlsGetInterruptStatus()** to return the ALS interrupt status.

Note: In level or window interrupt modes range errors will only trigger an interrupt if the logical conditions described above are met.

Continuous mode limits

To take account of oscillator tolerances and internal processing overheads it is necessary to place the following constraints on continuous mode operations. The following equations define the minimum inter-measurement period to ensure correct operation:

Continuous range:

$$\text{VL6180x_RangeSetMaxConvergenceTime()} + 5 \leq \text{VL6180x_RangeSetInterMeasPeriod()} * 0.9$$

Continuous ALS:

$$\text{VL6180x_AlsSetIntegrationPeriod()} * 1.1 \leq \text{VL6180x_AlsSetInterMeasurementPeriod()} * 0.9$$

Interleaved mode:

$$(\text{VL6180x_RangeSetMaxConvergenceTime()} + 5) + (\text{VL6180x_AlsSetIntegrationPeriod()} * 1.1) \leq \text{VL6180x_AlsSetInterMeasurementPeriod()} * 0.9$$

Table 9. gives an example how to apply these limits in continuous interleaved mode operating at a sampling rate of 10 Hz.

Table 9. Interleaved mode limits (10 Hz operation)

Parameter	Period (ms)
VL6180x_AlsSetInterMeasurementPeriod()	100
Effective ALS INTERMEASUREMENT PERIOD	90
VL6180x_RangeSetMaxConvergenceTime()	30
Total RANGE EXECUTION TIME	35
VL6180x_AlsSetIntegrationPeriod()	50
Total ALS INTEGRATION TIME	55
TOTAL EXECUTION TIME	90

2.5.3 Asynchronous mode - single shot range measurement

Host requests a single shot measurement and can either check regularly to see if result is ready or wait for an interrupt then call **RangeGetMeasurementIfReady()**.

Figure 17. Asynchronous mode

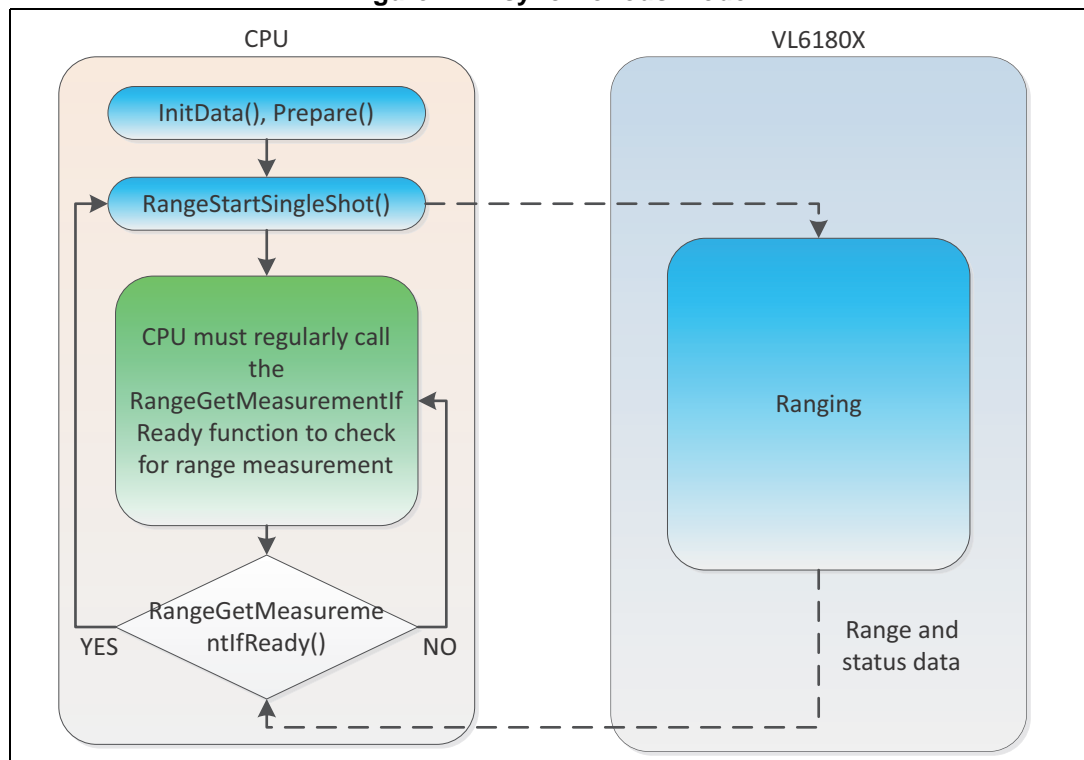

2.5.4 Interleaved mode

Figure 19. describes the continuous interleaved mode of operation where an ALS measurement is immediately followed by a range measurement and repeated after an interval specified by the ALS inter-measurement period.

Figure 18. Interleaved mode

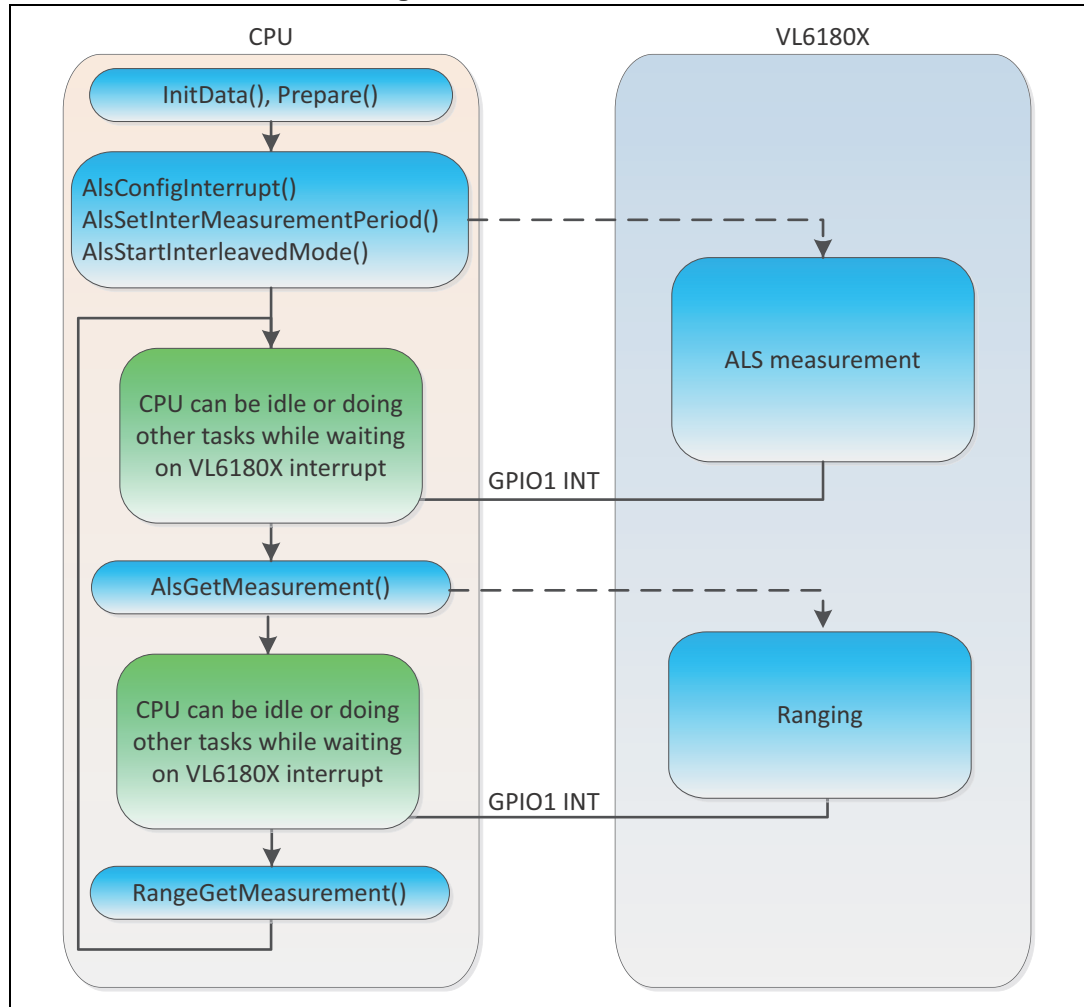

Note: Continuous range settings have no effect in this mode.

Figure 19. Interleaved mode

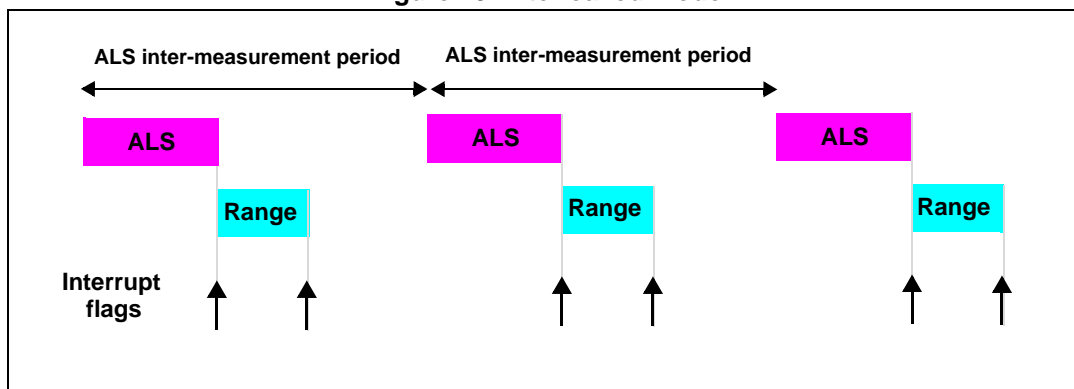

Note: To ensure correct operation in any of the continuous modes, the user must ensure that the inter-measurement period is sufficient for the operation to be completed within the inter-measurement period. Failure to do so could result in unpredictable behavior.

2.6 History buffer

History buffer not yet implemented in API.

The history buffer is a 8 x 16-bit memory which can be used to store the last 16 range measurements (8-bit) or 8 ALS samples (16-bit). Use of the history buffer is controlled via register `SYSTEM__HISTORY_CTRL{0x12}`. There are 3 basic functions:

- enable
- range or ALS selection
- clear buffer

The buffer is read via eight 16-bit registers (`RESULT__HISTORY_BUFFER_0{0x52}` to `RESULT__HISTORY_BUFFER_7{0x60}`). The buffer holds the last 16 x 8-bit range or 8 x 16-bit ALS results as shown in [Table 10](#).

Table 10. History buffer

History buffer	Range		ALS
	(High byte)	(Low byte)	(Word)
0	Range [15] (newest)	Range [14]	ALS [7] (newest)
1	Range [13]	Range [12]	ALS [6]
2	Range [11]	Range [10]	ALS [5]
3	Range [9]	Range [8]	ALS [4]
4	Range [7]	Range [6]	ALS [3]
5	Range [5]	Range [4]	ALS [2]
6	Range [3]	Range [2]	ALS [1]
7	Range [1]	Range [0] (oldest)	ALS [0] (oldest)

Note: Only one data stream (ALS or range) can be buffered at one time. There is no associated time stamp information.

The clear buffer command is not immediate; it takes effect on the next range or ALS start command.

The history buffer works independently of interrupt control i.e. the history buffer records all new samples; its operation is unchanged in threshold and window modes.

2.7 Range Sensor

The VL6180X contains a range sensor capable of measuring distance up to 10cm (ranging beyond 10cm is condition dependent). This section describes the main features of the range sensor. The range sensor performance specification can be found in [Section 3.1](#).

2.7.1 Range timing

[Figure 20](#) gives a breakdown of total execution time for a single range measurement.

- The pre-calibration phase is fixed (3.2 ms).
- The range convergence time is variable and depends on target distance/reflectance (see [Table 11](#)).
- The recommended readout averaging period is 4.3 ms. Readout averaging helps to reduce measurement noise. The recommended setting for `READOUT__AVERAGING_SAMPLE_PERIOD{0x10A}` is 48^(c) but is programmable in the range 0-255. Note however that lower settings will result in increased noise.

Register `READOUT__AVERAGING_SAMPLE_PERIOD{0x10A}` is not programmable via the API.

Note: When a target is detected the API returns the actual range convergence time. The convergence time returned by the API does not include the readout average. Range convergence and readout averaging must be completed within the specified max convergence time.

VL6180x_RangeSetMaxConvergenceTime() - sets maximum time to run measurement in all ranging modes. Range = 1 - 63 ms; measurement aborted when limit reached. Effective max convergence time depends on the actual convergence time plus readout averaging sample period setting.

Figure 20. Total range execution time

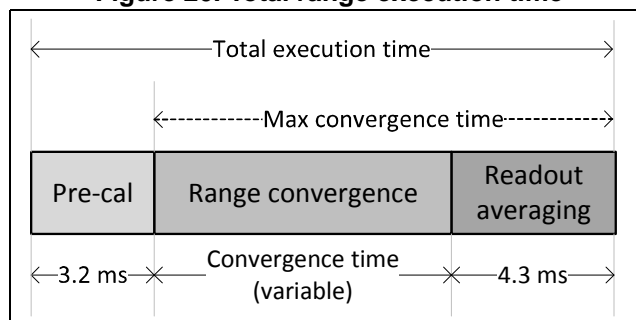

c. Default readout averaging period is calculated as follows: $1300 \mu s + (48 \times 64.5 \mu s) = 4.3 \text{ ms}$

Table 11. Typical range convergence time (ms)

Range (mm)	Target reflectance			
	3%	5%	17%	88%
10	0.43	0.33	0.18	0.18
20	0.94	0.73	0.28	0.18
30	1.89	1.40	0.51	0.18
40	3.07	2.25	0.81	0.18
50	4.35	3.24	1.18	0.24
60	5.70	4.22	1.60	0.32
70	7.07	5.35	2.07	0.49
80	8.41	6.45	2.58	0.50
90	9.58	7.56	3.14	0.61
100	10.73	8.65	3.69	0.73

2.7.2 Range error codes

Before using a measurement returned with a range API function, the application must first check that the function call has succeeded (returned 0) and then check the **Range.errorStatus** for possible error codes.

[Table 12](#) gives a summary of the error codes. Calling **VL6180x_RangeGetStatusErrString()** will also return the range error code/description.

Table 12. Range error codes

Bits [7:4]	Error code	Description
0	No error	Valid measurement
1-5	System error	System error detected (can only happen on power on). No measurement possible.
6	Early convergence estimate	ECE check failed
7	Max convergence	System did not converge before the specified max. convergence time limit
8	Range ignore	Ignore threshold check failed
9-10	Not used	-
11	Signal to Noise (SNR)	Ambient conditions too high. Measurement not valid
12/14	Range underflow	Range value < 0 If the target is very close (0-10mm) and the offset is not correctly calibrated it could lead to a small negative value

Table 12. Range error codes (continued)

Bits [7:4]	Error code	Description
13/15	Range overflow	Range value out of range. This occurs when the target is detected by the device but is placed at a high distance (> 200mm) resulting in internal variable overflow.
16	Ranging_Filtered ⁽¹⁾	Distance filtered by Wrap Around Filter (WAF). Occurs when a high reflectance target is detected between 600mm to 1.2m
17	Not used	-
18	Data_Not_Ready	Error returned by VL6180x_RangeGetMeasurementIfReady() when ranging data is not ready.

1. Errors 16 & 18 require VL6180X API.

2.7.3 Range checks

Error codes 6, 8 and 11 in [Table 12](#) are configurable by the user (SNR, error 11, has not yet been integrated into the API).

Early convergence estimate (ECE)

Early convergence estimate (ECE) is a programmable feature designed to minimize power consumption when there is no target in the field-of-view (FOV).

The system is said to have 'converged' (i.e. range acquired), when the convergence threshold^(d) is reached before the max. convergence time limit (see [Figure 21](#)). This ratio specifies the minimum return signal rate required for convergence. If there is no target in the FOV, the system will continue to operate until the max. convergence time limit is reached before switching off thereby consuming power. With ECE enabled, the system estimates the return signal rate 0.5 ms after the start of every measurement. If it is below the ECE threshold, the measurement is aborted and an ECE error is flagged.

Figure 21. Early convergence estimate (ECE)

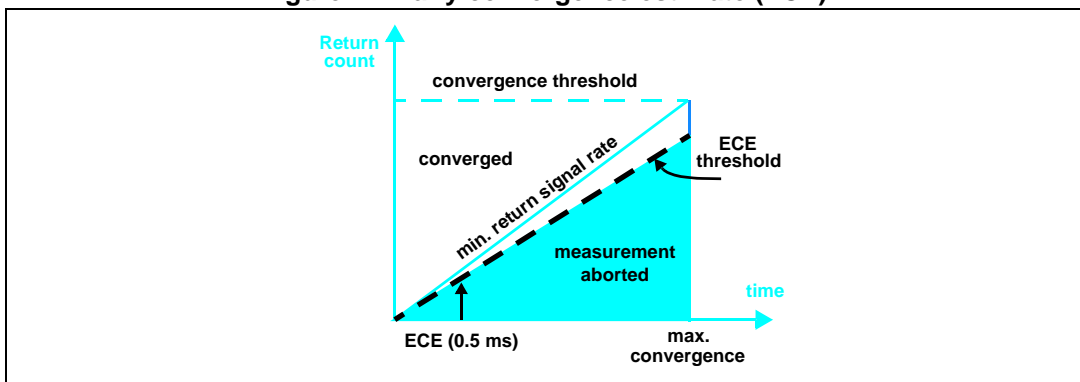

d. For standard ranging, the convergence threshold is set to 15360. The convergence threshold register is not accessible by the user.

ECE is enabled by setting **VL6180x_RangeSetEceState()** and configured with **VL6180x_RangeSetEceFactor()**. This allows the user to change the ECE threshold from the default of 15% below minimum convergence rate. As shown by the example below.

$$\text{ECE threshold} = \frac{85\% \times 0.5 \times 10240}{\text{Max convergence time (in ms)}}$$

If the max convergence time is set to 30 ms (using **VL6180x_RangeSetMaxConvergenceTime()**), then the ECE threshold is 196. That is, if the return count is less than 196 after 0.5 ms, the measurement will be aborted.

Note: The optimum value for the ECE threshold should be determined in the final application.

Range ignore

In a system with cover glass, the return signal from the glass (cross-talk) may be sufficient to cause the system to converge and return a valid range measurement even when there is no target present. The range ignore feature is designed to ensure that the system does not range on the glass. (Cross-talk is described in more detail in [Section 2.8.2](#)).

The ignore threshold is enabled with **VL6180x_RangeIgnoreSetEnable()**. If enabled, the ignore threshold and valid height must be specified, this is set with **VL6180x_RangeIgnoreConfigure()**.

A range ignore error will be flagged if the return signal rate is less than the ignore threshold.

Note: The optimum value for the ignore threshold should be determined in the final application.

Signal-to-noise ratio (SNR)

SNR function not yet implemented in API.

In high ambient conditions range accuracy can be impaired so the SNR threshold is used as a safety limit to invalidate range measurements where the ambient/signal ratio is considered too high. The default ambient/signal ratio limit is 10 (i.e. an SNR of 0.1) which is then encoded in 4.4 format as follows:

$$\text{SYSRANGE_MAX_AMBIENT_LEVEL_MULT}\{0x2C\} = 10 \times 16 = 160$$

To enable the SNR check, set bit 4 in **SYSRANGE_RANGE_CHECK_ENABLES** (0x02D). A lower setting results in a more aggressive filter which will result in a lower effective range but greater accuracy. A higher setting results in a less aggressive filter which will result in a greater effective range but lower accuracy.

The SNR value can be calculated as follows:

$$\text{SNR} = \frac{\text{RESULT_RANGE_RETURN_SIGNAL_COUNT}\{0x6C\}}{\text{RESULT_RANGE_RETURN_AMB_COUNT}\{0x74\} * 6}$$

Note: The SNR value is the inverse of the ambient/signal ratio limit {0x2C}.

Note: The optimum value for SNR threshold should be determined in the final application.

2.7.4 Manual/autoVHV calibration

Manual/auto VHV not yet implemented in API.

SPAD^(e) sensitivity is temperature dependent so VHV^(f) calibration is used to regulate SPAD sensitivity over temperature in order to minimize signal rate variation. VHV calibration is performed either manually by the host processor or automatically by internal firmware. Execution time is typically 200 μs so has no impact on normal operation.

A VHV calibration is run once at power-up and then automatically after every N range measurements defined by the `SYSRANGE__VHV_REPEAT_RATE{0x31}` register. AutoVHV calibration is disabled by setting this register to 0. Default is 255. If autoVHV is disabled it is recommended to run a manual VHV calibration periodically to recalibrate for any significant temperature variation. A manual VHV calibration is performed by setting `SYSRANGE__VHV_RECALBRATE{0x2E}` to 1. This register auto-clears. This operation should only be performed in software standby.

2.7.5 Wrap Around Filter

Wrap-around is an effect linked to the ratio between the VCSEL pulse period and the photon return pulse.

Figure 22. Wrap around - far target

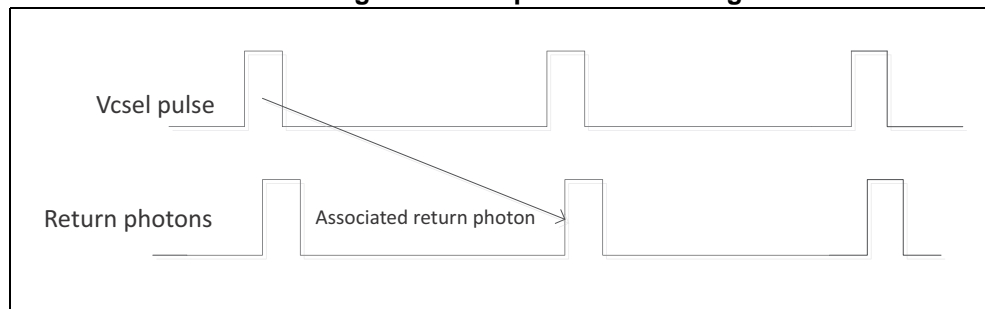

Highly reflective targets (like mirrors) placed at a far distance (>600mm) from the VL6180X can still produce enough return signal for the VL6180X to declare a valid target and meet the wrap-around condition resulting in a wrong (under-estimated) returned distance.

The WAF implemented in the API is able to automatically detect if a target is in the wrap-around condition and filter it by returning an invalid distance (**Range.errorStatus = 16**). The WAF is enabled/disabled via `VL6180x_FilterSetState()` and read with `VL6180x_FilterGetState()`.

2.7.6 Maximum ranging distance (DMAX)

A target placed in front of the VL6180X device may not be detected because it is too far away for the given ambient light conditions.

When ambient light level increases, max detection range (Dmax) decreases.

e. Photon detectors - Single Photon Avalanche Diodes

f. VHV is an adjustable SPAD bias voltage and stands for Very High Voltage (typically around 14 V). Also sometimes referred to as CP (Charge Pump).

When no target is detected (no valid distance), the VL6180X API is able to estimate Dmax as the maximum distance up to which a 17% target would have been detected with the current ambient light level.

When no target is detected by the VL6180X, the application can interpret the Dmax value as no target is detected and there is no 17% (or above) target between 0 and Dmax mm.

DMAX is enabled/disabled by **VL6180x_DMaxSetState()** and read with **VL6180x_DMaxGetState()**.

Note: Dmax is estimated for a 17% reflectance target. If the real target has a lower reflectance, then the Dmax calculated by the API could be overestimated.

Note: DMAX requires a large amount of software computation, that may represent a high time overhead for some low MHz CPU. It should be disabled if not required.

2.8 Other ranging system considerations

This section describes part-to-part range offset and system cross-talk. In addition, a procedure for cross-talk calibration is given.

2.8.1 Part-to-part range offset

The VL6180X is factory calibrated to produce an absolute linear range output as shown in [Figure 23](#). The part-to-part range offset is calibrated during manufacture and stored in NVM. Use `VL6180x_GetOffsetCalibrationData()` to read offset from device (immediately after `VL6180x_InitData()` this will be the NBVM programmed value). The API always returns the range with the part-to-part offset already applied.

Figure 23. Part-to-part range offset

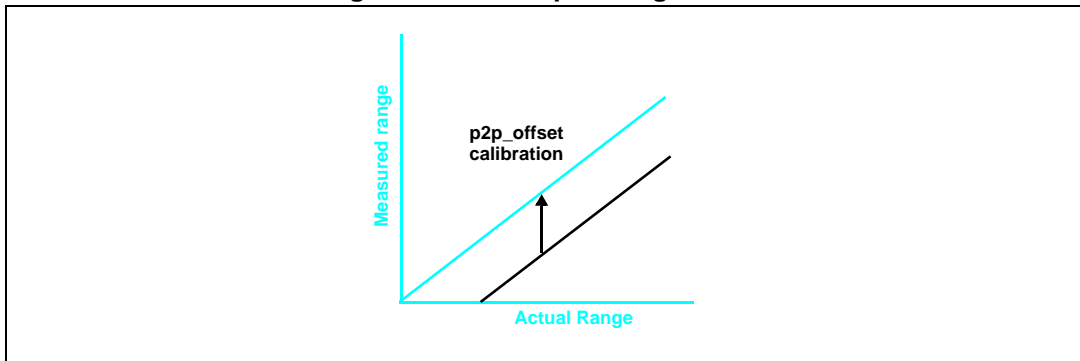

2.8.2 Cross-talk

Cross-talk is defined as the signal return from the cover glass. The magnitude of the cross-talk depends on the type of glass, air gap and filter material. Cross-talk results in a range error (see [Figure 24](#)) which is proportional to the ratio of the cross-talk to the signal return from the target. The true range is recovered by applying automatic cross-talk compensation.

Figure 24. Cross-talk compensation

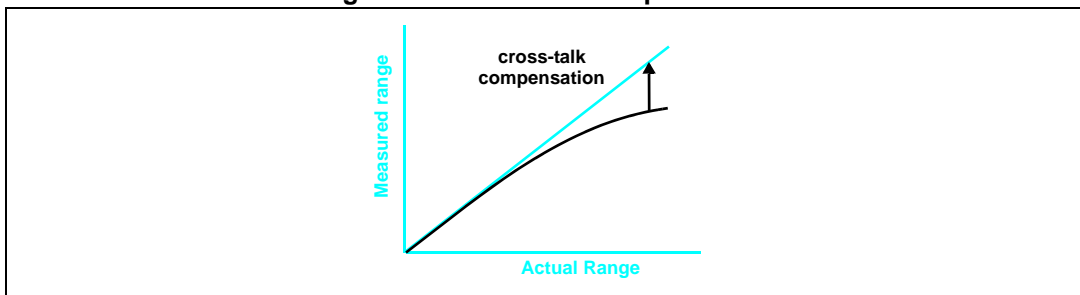

Cross-talk compensation is enabled by using `VL6180x_SetXTalkCompensationRate()`. A cross-talk calibration procedure is described in [Section 2.8.4](#).

2.8.3 Offset calibration procedure

Complete steps 1-4 to see if part-to-part offset calibration is required.

1. Turn off WAF **VL6180x_FilterSetState()** = 0, turn off range ignore features **VL6180x_RangeIgnoreSetEnable()** = 0 and clear all interrupts **VL6180x_ClearAllInterrupt()**.
2. Position a white target (88% reflectance^(g)) at a distance of 50mm from the top of the cover glass.
3. Perform a minimum of 10 range measurements and compute the average range using **VL6180x_RangePollMeasurement()**.
4. If the average range is within target distance ± 3 mm, offset calibration is not required. Otherwise, complete the calibration procedure.
5. Set **VL6180x_SetOffsetCalibrationData()** = 0.
6. Perform a minimum of 10 range measurements and compute the average range from **VL6180x_RangePollMeasurement()**.
7. Calculate the part-to-part offset as follows:

$$\text{part-to-part offset} = \text{target distance(mm)} - \text{average range(mm)}$$

8. The new offset value should be stored on system and written to the VL6180X by using **VL6180x_SetOffsetCalibrationData()** each time the device is reset.

2.8.4 Cross-talk calibration procedure

This section describes a procedure for calibrating system cross-talk.

1. Perform offset calibration if required (see [Section 2.8.3](#)) and write the value to the device by using **VL6180x_SetOffsetCalibrationData()**.

Note: If the offset is incorrectly calibrated, cross-talk calibration will be inaccurate.

2. Turn off WAF **VL6180x_FilterSetState()** = 0, turn off range ignore features **VL6180x_RangeIgnoreSetEnable()** = 0 and clear all interrupts **VL6180x_ClearAllInterrupt()**.
3. Position a black target (3% reflectance^(h)) at a distance of 100mm from the top of the cover glass.
4. Write 0 to **VL6180x_SetXTalkCompensationRate()**.
5. Perform a minimum of 10 range measurements and compute the average return rate and range value from **VL6180x_RangePollMeasurement()**.
6. Calculate the cross-talk factor as follows:

$$\text{cross-talk (in Mcps)} = \text{average return rate} \times \left(1 - \frac{\text{average range(mm)}}{\text{target distance(mm)}}\right)$$

7. The cross-talk value should be stored on system and written to the VL6180X by using **VL6180x_SetXTalkCompensationRate()** each time the device is reset.

Note: Cross-talk compensation is only applied to targets above 20 mm. This is to ensure that cross-talk correction is not applied to near targets where the signal rate is decreasing.

g. Target reflectance should be high but absolute value is not critical.

h. Target reflectance should be low but absolute value is not critical.

2.8.5 Cross-talk limit

A practical limit for cross-talk is < 3.0 Mcps for standard ranging. This is based on two factors:

1. The return rate for a 3% reflective target at 100 mm without glass is typically around 1.5 Mcps. If glass is added with a cross-talk of 3.0 Mcps, the resultant return rate will be 4.5 Mcps. This results in a cross-talk correction factor of x3 so for a 100 mm target the raw range will be in the region of 30 mm. To ensure the cross-talk valid height restriction is not breached, the minimum raw range allowing for noise margin is around 30 mm.
2. A cross-talk correction factor of x3 also means that any range noise will be multiplied by 3 so noise also becomes a limiting factor.

2.8.6 Cross-talk vs air gap

Figure 25 shows the typical cross-talk vs air gap using low cross-talk cover glass. Above 1.5 mm, the cross-talk rises rapidly.

Figure 25. Cross-talk vs air gap

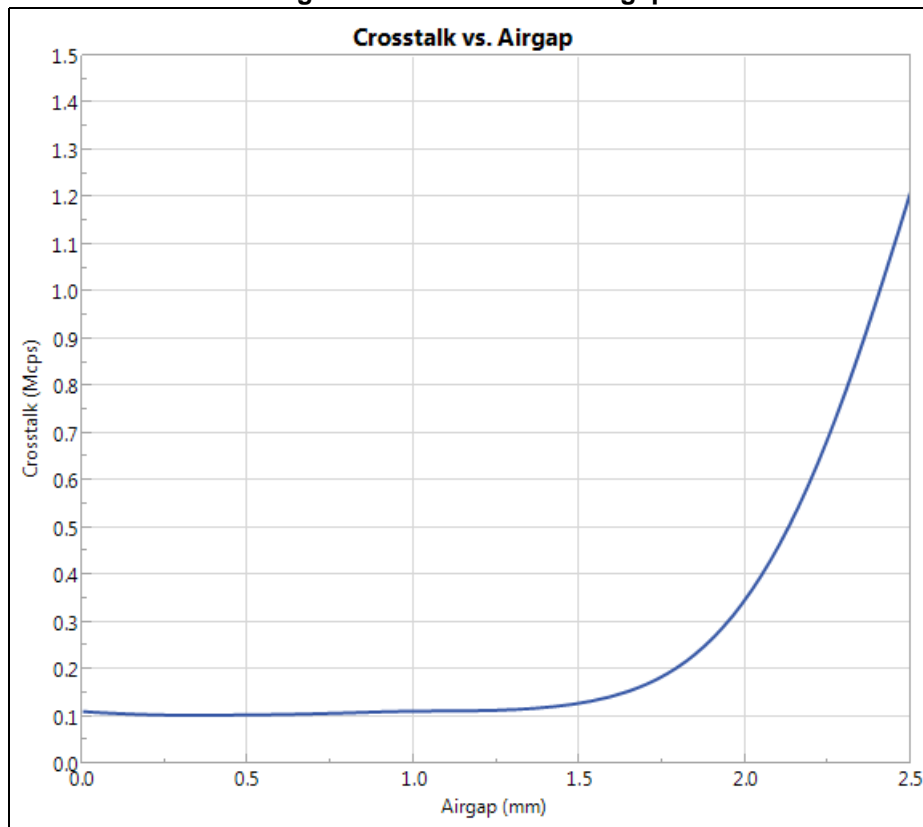

2.9 Current consumption

Table 13. gives an overview of current consumption in different operating states.

Table 13. Typical current consumption in different operating states

Mode	Current	Conditions
Hardware standby	< 1 μ A	Shutdown (GPIO0 = 0). No I ² C comms
Software standby	< 1 μ A	After MCU boot. Device ready
ALS	300 μ A	During integration
Ranging	1.7 mA	Average consumption during ranging ⁽¹⁾

1. 10 Hz sampling rate, 17% reflective target at 50 mm.

2.9.1 Ranging current consumption

Figure 26. shows typical ranging current consumption of the VL6180X. Current consumption depends on target distance, target reflectance and sampling rate. The example shown here is based on default settings and a sampling rate of 10 Hz. The average current consumption for a 17% reflective target at 50 mm operating at 10 Hz is 1.7 mA. At different sampling rates the current consumption scales accordingly i.e. the average current consumption at 1 Hz under the same conditions would be 0.17 mA.

Figure 26. Typical ranging current consumption (10 Hz sampling rate)

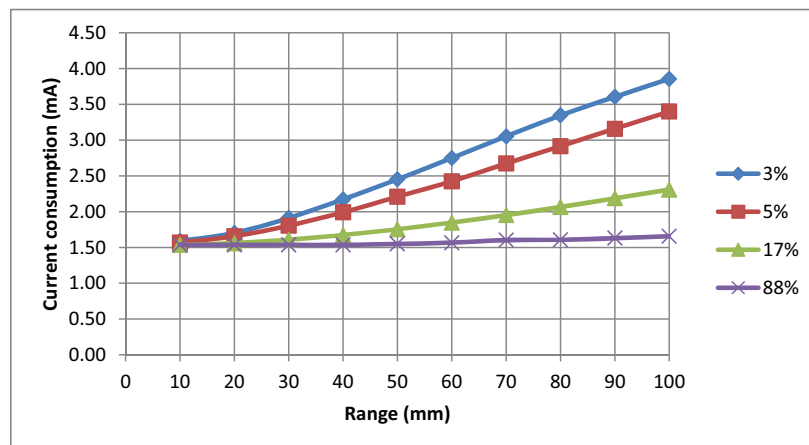

The minimum average current consumption in Figure 26. is 1.5 mA, 0.5 mA of which comes from pre-calibration before each measurement and 1.0 mA from post-processing (readout averaging). Pre-calibration is a fixed overhead but readout averaging can be reduced or effectively disabled by setting the READOUT_AVERAGING_SAMPLE_PERIOD{0x10A} to zero (default setting is 48).

Note: Decreasing the READOUT_AVERAGING_SAMPLE_PERIOD will increase sampling noise. It is recommended that any change in setting be properly evaluated in the end application.

Minimum current consumption scales with sampling rate i.e. at a sampling rate of 1 Hz the current consumption associated with pre- and post-processing will be 0.15 μ A.

2.9.2 Current consumption calculator

Table 14. gives a breakdown of typical current consumption for pre-calibration, ranging and readout averaging.

Table 14. Breakdown of current consumption

Label	Phase	I (mA)	t (ms)	Q (μC) = I x t
Q ₁	Pre-calibration	13.0	3.2	41.6
Q ₂	Ranging	22.0	per ms	22.0 per ms
Q ₃	Readout averaging	25.0	per ms	25.0 per ms

Current consumption can then be calculated as follows:

$$I (\mu A) = \text{sampling_rate} * [Q_1 + (Q_2 * \text{RESULT_RANGE_RETURN_CONV_TIME in ms}) + Q_3 * (1.3 + (\text{READOUT_AVERAGING_SAMPLE_PERIOD} * 0.0645 \text{ ms}))]$$

Table 11. gives typical convergence times for different target reflectance.

So, for example, RESULT_RANGE_RETURN_CONV_TIME for a 3% target at 50 mm is 4.35 ms. At 10 Hz sampling rate this gives:

$$I (\mu A) = 10 * [41.6 + (22 * 4.35) + 25 * (1.3 + (48 * 0.0645))] = 2472 \mu A$$

2.9.3 Current distribution

Table 15. shows how current consumption is distributed between the two supplies in ranging mode. AVDD_VCSEL supplies the VCSEL current and AVDD supplies all other functions.

Angle of divergent laser emission is 25° +/- 5°.

The condition of divergent angle of 25° laser emission is 1/e² of the peak intensity

Note: The VCSEL driver is pulsed at 100 MHz with a 33% duty cycle (see Figure 27.) so average current consumption on AVDD_VCSEL is one third of the peak.

Table 15. Current consumption on AVDD and AVDD_VCSEL

Power supply ⁽¹⁾	Current	Note
AVDD	14 mA	Average during active ranging
AVDD_VCSEL	8 mA ⁽²⁾	Average during active ranging (33% duty cycle).

- Normally, both supplies will be driven from a common source giving a peak instantaneous current demand of 38 mA.
- Peak emitter current during ranging is 24 mA. Peak power is 14mW.

Figure 27. VCSEL pulse duty cycle

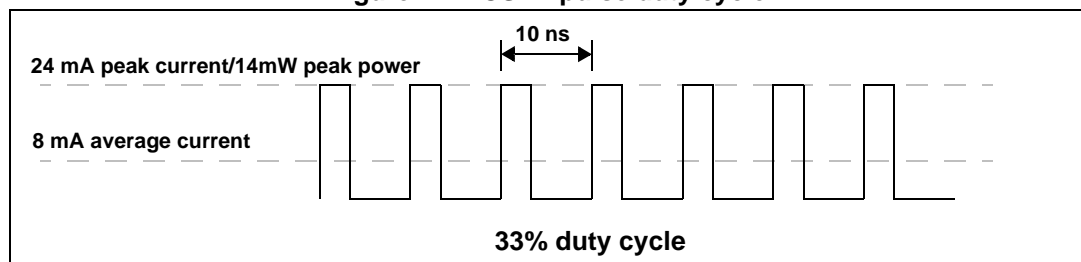

2.10 Ambient light sensor (ALS)

The VL6180X contains an ambient light sensor capable of measuring the ambient light level over a wide dynamic range. This section describes the main features of the ALS. The ALS performance specification can be found in [Section 3.2](#).

2.10.1 Field of view

[Figure 28](#) shows the ALS field of view which is typically 42 degrees (half angle, 40% of peak) in both X and Y.

Figure 28. ALS angular response

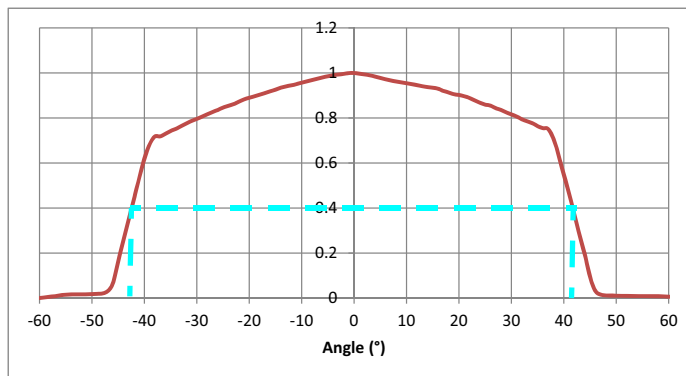

2.10.2 Spectral response

The spectral response of the ALS compared to photopic response is shown in [Figure 29](#).

Figure 29. ALS spectral response

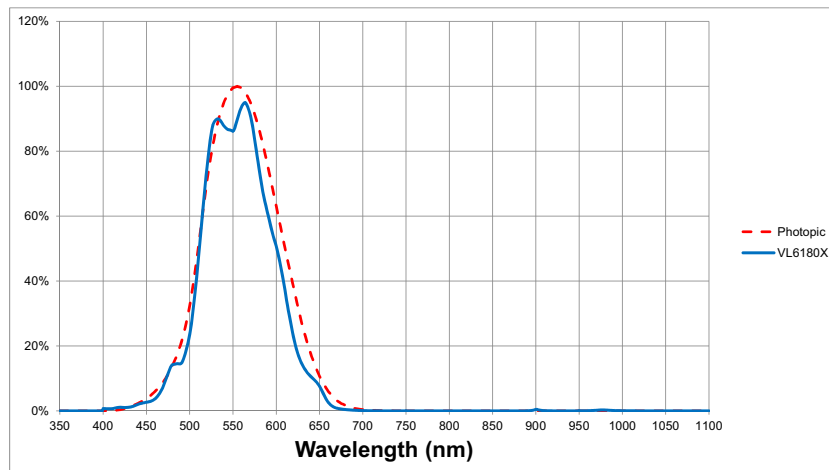

2.10.3 ALS dynamic range

Table 16 shows the range of measurable light at all gains both with and without glass. In most applications operating at a single gain setting should be possible.

Table 16. ALS dynamic range⁽¹⁾

Analogue gain setting	Dynamic range (no glass)		Dynamic range (10% transmissive glass)	
	Min. (Lux) ⁽²⁾	Max. (Lux)	Minimum (Lux)	Maximum (Lux)
1	3.20	20800	32.0	>100,000
1.25	2.56	16640	25.6	>100,000
1.67	1.93	12530	19.3	>100,000
2.5	1.28	8320	12.8	83,200
5	0.64	4160	6.4	41,600
10	0.32	2080	3.2	20,800
20	0.16	1040	1.6	10,400
40	0.08	520	0.8	5,200

1. ALS lux resolution = 0.32 lux/count
2. Minimum of 10 counts

2.10.4 ALS count to lux conversion

The output from the ambient light sensor is a 16 bit count value, this count output is proportional to the light level and is converted into lux with **VL6180x_AlsGetLux()**. The ALS read measurement functions **VL6180x_AlsPollMeasurement()** & **VL6180x_AlsGetMeasurement()** both call this function.

The conversion from count to lux is dependent on the ALS lux resolution, ALS gain and integration period:

$$\text{Light level (in lux)} = \text{ALS lux resolution} \times \frac{\text{ALS count}}{\text{Analog gain}} \times \frac{100 \text{ ms}}{\text{ALS integration time}}$$

The factory calibrated ALS lux resolution is 0.32 lux/count for an analog gain of 1 & 100ms integration time (calibrated without glass). The current lux resolution value can be read by using **VL6180x_AlsGetLuxResolutionFactor()**.

The ALS lux resolution will require re-calibration in the final system where cover glass is used. This can be done by reading the lux value with and without glass under the same conditions and multiplying the ALS lux resolution by the ratio of the two values as shown below. The new value can be written to the device by using **VL6180x_AlsSetLuxResolutionFactor()**.

$$\text{ALS lux resolution (with glass)} = \frac{\text{LuxValue (without glass)}}{\text{LuxValue (with glass)}} \times \text{ALS lux resolution (without glass)}$$

2.10.5 Integration period

The integration period (**VL6180x_AlsSetIntegrationPeriod()**) is the time over which a single ALS measurement is made. The default integration period is 100ms. Integration times in the range 50-100 ms are recommended to reduce impact of light flicker from artificial lighting.

2.10.6 ALS gain selection

Eight analog gain settings (**VL6180x_AlsSetAnalogueGain()**) are available which can be selected manually depending on the range and resolution required. shows the actual characterized gains versus the design targets. If a gain setting other than gain 20 is used, marginally greater accuracy can be achieved by using the actual gain values in the light level equation in [Section 2.10.4](#) when calculating the lux light level.

Table 17. Actual gain values

VL6180x_AlsSetAnalogueGain	Analog gain setting	Actual gain values
0x46	1	1.01
0x45	1.25	1.28
0x44	1.67	1.72
0x43	2.5	2.60
0x42	5	5.21
0x41	10	10.32
0x40	20	20
0x47	40	40

2.10.7 Scaler

In addition to analogue gain, the VL6180X has a scaler that multiplies the ALS count prior to the result being read. This value, in addition to the analogue gain is useful in very low light conditions to increase the dynamic range.

The scaler can be a value between 1 to 16 (default 1) and is set with **VL6180x_ALSSetScaler()** and read with **VL6180x_ALSGetScaler()**.

3 Performance specification

3.1 Proximity ranging (0 to 100mm)

The following table specifies ranging performance up to 100mm. Ranging beyond 100mm is possible with certain target reflectances and ambient conditions but not guaranteed. These results are derived from characterization of both typical and corner samples (representative of worst case process conditions).

Unless specified otherwise, all results were performed at room temperature (23°C), nominal voltage (2.8V) and in the dark. Results are based on the average of 100 measurements for a 17% reflective target @ 50mm.

Table 18. Ranging specification

Parameter	Min.	Typ.	Max.	Unit
Noise ⁽¹⁾	-	-	2.0	mm
Range offset error ⁽²⁾	-	-	13	mm
Temperature dependent drift ⁽³⁾	-	9	15	mm
Voltage dependent drift ⁽⁴⁾	-	3	5	mm
Convergence time ⁽⁵⁾	-	-	15	ms

1. Maximum standard deviation of 100 measurements
2. Maximum offset drift after 3 reflow cycles. This error can be removed by re-calibration in the final system
3. Tested over optimum operating temperature range (see [Table 23.: Normal operating conditions](#))
4. Tested over optimum operating voltage range (see [Table 23.: Normal operating conditions](#))
5. Based on a 3% reflective target @ 100 mm

3.1.1 Max range vs. ambient light level

The data shown in this section is worst case data **for reference only**.

[Table 19](#) shows the worst case maximum range achievable under different ambient light conditions

Table 19. Worst case max range vs. ambient 0 to 100mm⁽¹⁾⁽²⁾

Target reflectance	In the dark ⁽³⁾	Worst case indoor light (1 kLux diffuse halogen)	High ambient light (5 kLux diffuse halogen)	Unit
3%	> 100	> 80	> 40	mm
5%	> 100	> 90	> 45	mm
17%	> 100	> 100	> 60	mm
88%	> 100	> 100	> 70	mm

1. Tested in an integrating sphere (repeatable lab test, not representative of real world ambient light) at 1 kLux and 5 kLux (halogen light source) using 80 x 80 mm targets. Due to high IR content, 5 kLux halogen light approximates to 10 kLux to 15 kLux natural sunlight.
2. SNR limit of 0.1 applied. Note: maximum range could be increased by reducing the SNR limit to 0.06
3. Also applicable to lighting conditions with low IR content e.g typical office fluorescent lighting

3.2 ALS performance

The following table specifies ALS performance. These results are derived from characterization of typical samples (without cover glass). Unless specified otherwise, all tests were performed at room temperature (23°C), nominal voltage (2.8V) and using a halogen light source.

Table 20. ALS performance

Parameter	Min.	Typ.	Max.	Unit
ALS sensitivity ⁽¹⁾	0.28	0.32	0.36	Lux/count
Angular response ⁽²⁾	-	42	-	degrees
Spectral response	-	photopic	-	-
Dynamic Range ⁽³⁾	0.002	-	20971	Lux
Linearity error (1 to 300 lux) ⁽⁴⁾	-	-	5	%
Linearity error (300 to 7500 lux) ⁽⁴⁾	-	-	10	%
Gain error (@ gain 20)	-	-	1	%
Gain error (gains 1 to 10)	-	-	7	%

1. 535nm LED @ 1 kLux. Measured @ gain 20.
2. Half angle. 40% transmission.
3. Minimum of one count at gain 40 and 400 ms ALS integration time.
4. Test conditions: -10°C to +60°C; analog gains 1 to 20

4 I²C control interface

The VL6180X is controlled over an I²C interface. The default I²C address is 0x29 (7-bit). This section describes the I²C protocol.

Figure 30. Serial interface data transfer protocol

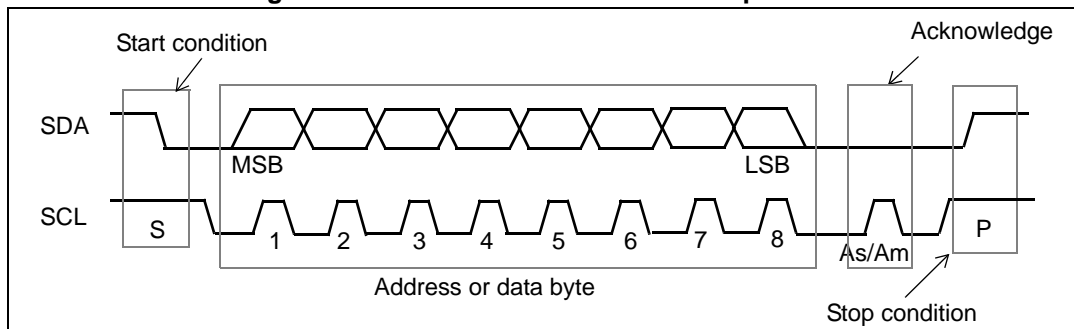

Information is packed in 8-bit packets (bytes) always followed by an acknowledge bit, As for sensor acknowledge and Am for master acknowledge. The internal data is produced by sampling SDA at a rising edge of SCL. The external data must be stable during the high period of SCL. The exceptions to this are start (S) or stop (P) conditions when SDA falls or rises respectively, while SCL is high.

A message contains a series of bytes preceded by a start condition and followed by either a stop or repeated start (another start condition but without a preceding stop condition) followed by another message. The first byte contains the device address (0x52) and also specifies the data direction. If the least significant bit is low (0x52) the message is a master write to the slave. If the lsb is set (0x53) then the message is a master read from the slave.

Figure 31. I²C device address

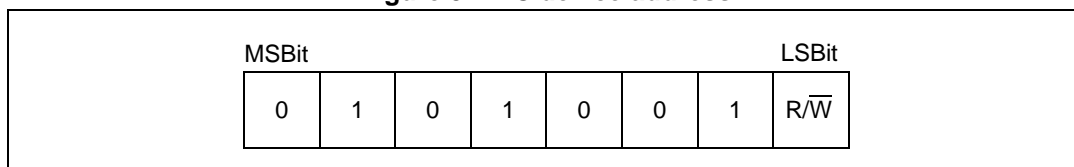

All serial interface communications with the sensor must begin with a start condition. The sensor acknowledges the receipt of a valid address by driving the SDA wire low. The state of the read/write bit (lsb of the address byte) is stored and the next byte of data, sampled from SDA, can be interpreted. During a write sequence the second and third bytes received provide a 16-bit index which points to one of the internal 8-bit registers.

Figure 32. Single location, single write)

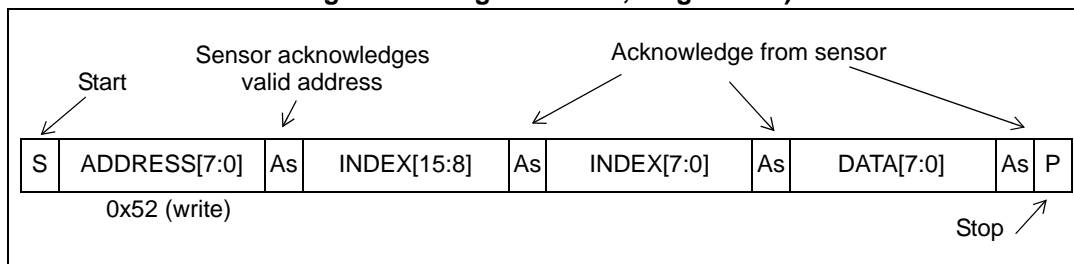

As data is received by the slave it is written bit by bit to a serial/parallel register. After each data byte has been received by the slave, an acknowledge is generated, the data is then stored in the internal register addressed by the current index.

During a read message, the contents of the register addressed by the current index is read out in the byte following the device address byte. The contents of this register are parallel loaded into the serial/parallel register and clocked out of the device by the falling edge of SCL.

Figure 33. Single location, single read

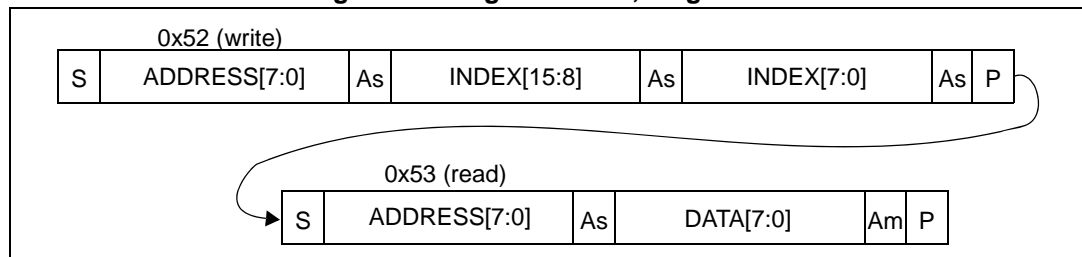

At the end of each byte, in both read and write message sequences, an acknowledge is issued by the receiving device (that is, the sensor for a write and the master for a read).

A message can only be terminated by the bus master, either by issuing a stop condition or by a negative acknowledge (that is, **not** pulling the SDA line low) after reading a complete byte during a read operation.

The interface also supports auto-increment indexing. After the first data byte has been transferred, the index is automatically incremented by 1. The master can therefore send data bytes continuously to the slave until the slave fails to provide an acknowledge or the master terminates the write communication with a stop condition. If the auto-increment feature is used the master does **not** have to send address indexes to accompany the data bytes.

Figure 34. Multiple location write

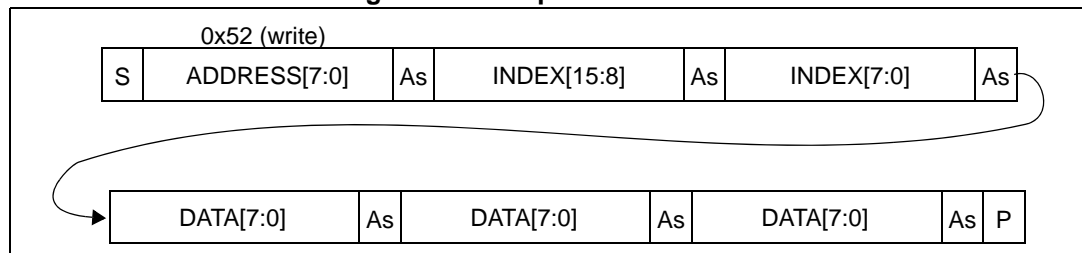
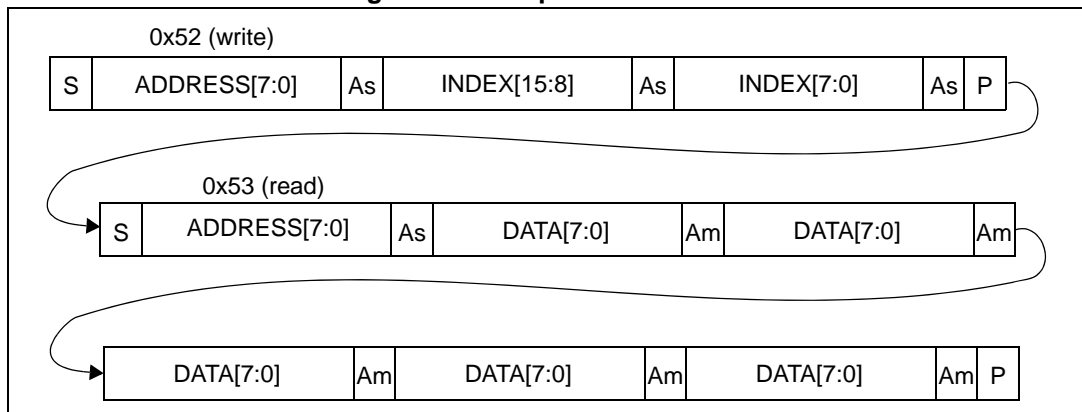

Figure 35. Multiple location read



4.1 I²C interface - timing characteristics

Timing characteristics are shown in [Table 21](#). Please refer to [Figure 36](#) for an explanation of the parameters used.

Table 21. I²C interface - timing characteristics

Symbol	Parameter	Minimum	Typical	Maximum	Unit
F _{I2C}	Operating frequency	0	-	400 ⁽¹⁾	kHz
t _{LOW}	Clock pulse width low	0.5	-	-	μs
t _{HIGH}	Clock pulse width high	0.26	-	-	μs
t _{SP}	Pulse width of spikes which are suppressed by the input filter	-	-	50	ns
t _{BUF}	Bus free time between transmissions	0.5	-	-	μs
t _{HD.STA}	Start hold time	0.26	-	-	μs
t _{SU.STA}	Start set-up time	0.26	-	-	μs
t _{HD.DAT}	Data in hold time	0	-	-	μs
t _{SU.DAT}	Data in set-up time	50	-	-	ns
t _R	SCL/SDA rise time	-	-	120	ns
t _F	SCL/SDA fall time	-	-	120	ns
t _{SU.STO}	Stop set-up time	0.26	-	-	μs
C _{i/o}	Input/output capacitance (SDA)	-	-	4	pF
C _{in}	Input capacitance (SCL)	-	-	4	pF
C _L	Load capacitance	-	125	-	pF

1. The maximum bus speed may also be limited by the combination of load capacitance and pull-up resistor. Please refer to the I²C specification for further information.

Figure 36. I²C timing characteristics

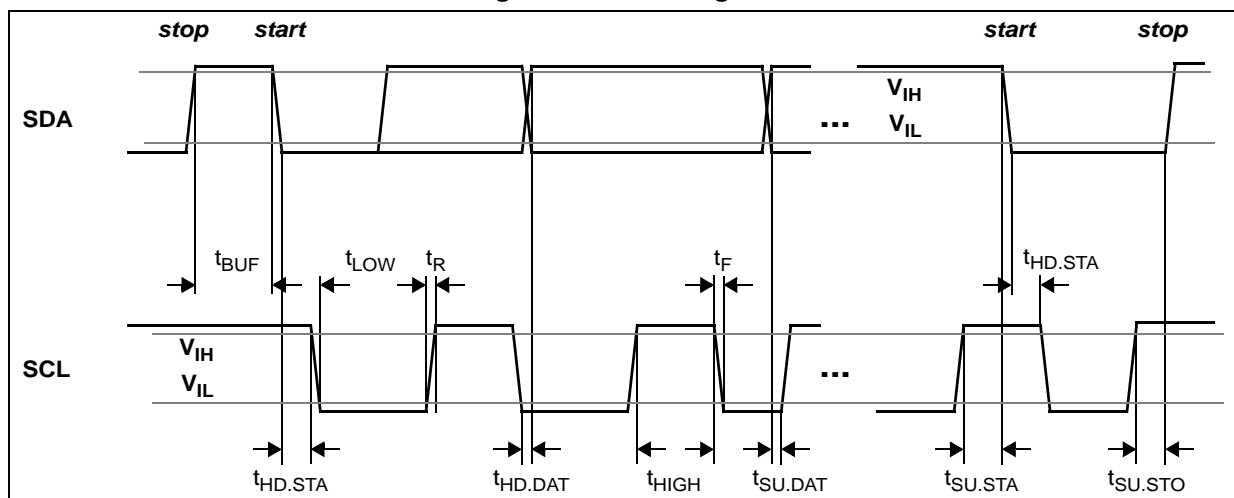

All timing characteristics are measured with respect to V_{IL_MAX} or V_{IH_MIN}.

5 Electrical characteristics

5.1 Absolute maximum ratings

Table 22. Absolute maximum ratings

Parameter	Min.	Typ.	Max.	Unit
AVDD	-0.5	-	3.6	V
AVDD_VCSEL	-0.5	-	3.6	V
SCL, SDA, GPIO0 and GPIO1	-0.5	-	3.6	V
VESD (Electrostatic discharge model)				
Human body model ⁽¹⁾	-2		2	KV
Charge device model ⁽²⁾	-500		500	V
Temperature (storage - manufacturing test)	-40	-	+85	°C

1. HBM tests are performed in compliance with ESDA/JEDEC JS-001-2010 (ex: JESD22-A114)
MM test is performed in compliance with JESD22-A115.
2. CDM ESD tests are performed in compliance with JESD22-C101.

Note: Stresses above those listed in [Table 22](#). may cause permanent damage to the device. This is a stress rating only and functional operation of the device at these or any other conditions above those indicated in the operational sections of the specification is not implied. Exposure to absolute maximum rating conditions for extended periods may affect device reliability.

5.2 Normal operating conditions

Table 23. Normal operating conditions

Parameter	Min.	Typ.	Max.	Unit
Voltage (AVDD and AVDD_VCSEL)				
Voltage (optimum operating)	2.7	2.8	2.9	V
Voltage (functional operating)	2.6	2.8	3.0	V
Temperature				
Temperature (optimum operating)	-10		+60	°C
Temperature (functional operating)	-20	-	+70	°C

5.3 Electrical characteristics

Table 24. Digital I/O electrical characteristics

Symbol	Parameter	Minimum	Typical	Maximum	Unit
CMOS digital I/O (SDA, SCL, GPIO0 and GPIO1)					
V_{IL}	Low level input voltage	-0.5	-	0.6	V
V_{IH}	High level input voltage	1.12	-	AVDD+0.5	V
V_{OL}	Low level output voltage (8mA load)	-	-	0.4	V
V_{OH}	High level output voltage (8mA load)	AVDD-0.4	-	-	V
I_{IL}	Low level input current	-	-	-10	μ A
I_{IH}	High level input current	-	-	10	μ A

6 Device registers

This section describes in detail all user accessible device registers. Registers are grouped by function as shown in [Table 25](#). to make them easier to read but also to simplify multi-byte read/write I²C accesses (burst mode). More details in [Section 4](#). Reset values are given for each register which denotes the register value in software standby.

Table 25. Register groups

Register group	Address range
IDENTIFICATION	0x00 - 0x0F
SYSTEM SETUP	0x10 - 0x17
RANGE SETUP	0x18 - 0x37
ALS SETUP	0x38 - 0x40
RESULTS	0x4D - 0x80

Note that registers can be 8-,16- or 32-bit. Multi-byte registers are always addressed in ascending order with MSB first as shown in [Table 26](#).

Table 26. 32-bit register example

Register address	Byte
Address	MSB
Address + 1	..
Address + 2	..
Address + 3	LSB

6.1 Register encoding formats

Some registers are encoded to allow rational numbers to be expressed efficiently. [Table 27](#) gives an explanation of 9.7 and 4.4 encoding formats.

Table 27. 9.7 and 4.4 register formats

Format	Description
4.4	8 bits = 4 integer bits + 4 fractional bits (stored as 1 byte) Encoding example: the value 4.2 is multiplied by 16 (2 ⁴) rounded and stored as 67 decimal. Decoding example: 67 is divided by 16 = 4.19.
9.7	16 bits = 9 integer bits + 7 fractional bits (stored over 2 bytes) Encoding example: the value 4.2 is multiplied by 128 (2 ⁷) rounded and stored as 537 decimal. Decoding example: 537 is divided by 128 = 4.19.

Table 28. Register summary

Offset	Register name	Reference
0x000	IDENTIFICATION__MODEL_ID	Section 6.2.1 on page 51
0x001	IDENTIFICATION__MODEL_REV_MAJOR	Section 6.2.2 on page 51
0x002	IDENTIFICATION__MODEL_REV_MINOR	Section 6.2.3 on page 51
0x003	IDENTIFICATION__MODULE_REV_MAJOR	Section 6.2.4 on page 52
0x004	IDENTIFICATION__MODULE_REV_MINOR	Section 6.2.5 on page 52
0x006	IDENTIFICATION__DATE_HI	Section 6.2.6 on page 52
0x007	IDENTIFICATION__DATE_LO	Section 6.2.7 on page 53
0x008:0x009	IDENTIFICATION__TIME	Section 6.2.8 on page 53
0x010	SYSTEM__MODE_GPIO0	Section 6.2.9 on page 54
0x011	SYSTEM__MODE_GPIO1	Section 6.2.10 on page 55
0x012	SYSTEM__HISTORY_CTRL	Section 6.2.11 on page 56
0x014	SYSTEM__INTERRUPT_CONFIG_GPIO	Section 6.2.12 on page 57
0x015	SYSTEM__INTERRUPT_CLEAR	Section 6.2.13 on page 57
0x016	SYSTEM__FRESH_OUT_OF_RESET	Section 6.2.14 on page 58
0x017	SYSTEM__GROUPED_PARAMETER_HOLD	Section 6.2.15 on page 58
0x018	SYSRANGE__START	Section 6.2.16 on page 59
0x019	SYSRANGE__THRESH_HIGH	Section 6.2.17 on page 59
0x01A	SYSRANGE__THRESH_LOW	Section 6.2.18 on page 60
0x01B	SYSRANGE__INTERMEASUREMENT_PERIOD	Section 6.2.19 on page 60
0x01C	SYSRANGE__MAX_CONVERGENCE_TIME	Section 6.2.20 on page 60
0x01E	SYSRANGE__CROSSTALK_COMPENSATION_RATE	Section 6.2.21 on page 61
0x021	SYSRANGE__CROSSTALK_VALID_HEIGHT	Section 6.2.22 on page 61
0x022	SYSRANGE__EARLY_CONVERGENCE_ESTIMATE	Section 6.2.23 on page 61
0x024	SYSRANGE__PART_TO_PART_RANGE_OFFSET	Section 6.2.24 on page 62
0x025	SYSRANGE__RANGE_IGNORE_VALID_HEIGHT	Section 6.2.25 on page 62
0x026	SYSRANGE__RANGE_IGNORE_THRESHOLD	Section 6.2.26 on page 62
0x02C	SYSRANGE__MAX_AMBIENT_LEVEL_MULT	Section 6.2.27 on page 63
0x02D	SYSRANGE__RANGE_CHECK_ENABLES	Section 6.2.27 on page 63
0x02E	SYSRANGE__VHV_RECALIBRATE	Section 6.2.29 on page 64
0x031	SYSRANGE__VHV_REPEAT_RATE	Section 6.2.30 on page 64
0x038	SYSALS__START	Section 6.2.31 on page 65
0x03A	SYSALS__THRESH_HIGH	Section 6.2.32 on page 65
0x03C	SYSALS__THRESH_LOW	Section 6.2.33 on page 66

Table 28. Register summary (continued)

Offset	Register name	Reference
0x03E	SYSALS__INTERMEASUREMENT_PERIOD	Section 6.2.34 on page 66
0x03F	SYSALS__ANALOGUE_GAIN	Section 6.2.35 on page 67
0x040	SYSALS__INTEGRATION_PERIOD	Section 6.2.36 on page 67
0x04D	RESULT__RANGE_STATUS	Section 6.2.37 on page 68
0x04E	RESULT__ALS_STATUS	Section 6.2.38 on page 69
0x04F	RESULT__INTERRUPT_STATUS_GPIO	Section 6.2.39 on page 70
0x050	RESULT__ALS_VAL	Section 6.2.40 on page 70
0x052:0x060 (0x2)	RESULT__HISTORY_BUFFER_x	Section 6.2.41 on page 71
0x062	RESULT__RANGE_VAL	Section 6.2.42 on page 72
0x064	RESULT__RANGE_RAW	Section 6.2.43 on page 72
0x066	RESULT__RANGE_RETURN_RATE	Section 6.2.44 on page 72
0x068	RESULT__RANGE_REFERENCE_RATE	Section 6.2.45 on page 73
0x06C	RESULT__RANGE_RETURN_SIGNAL_COUNT	Section 6.2.46 on page 73
0x070	RESULT__RANGE_REFERENCE_SIGNAL_COUNT	Section 6.2.47 on page 74
0x074	RESULT__RANGE_RETURN_AMB_COUNT	Section 6.2.48 on page 74
0x078	RESULT__RANGE_REFERENCE_AMB_COUNT	Section 6.2.49 on page 74
0x07C	RESULT__RANGE_RETURN_CONV_TIME	Section 6.2.50 on page 75
0x080	RESULT__RANGE_REFERENCE_CONV_TIME	Section 6.2.51 on page 75
0x10A	READOUT__AVERAGING_SAMPLE_PERIOD	Section 6.2.52 on page 75
0x119	FIRMWARE__BOOTUP	Section 6.2.52 on page 75
0x120	FIRMWARE__RESULT_SCALER	Section 6.2.53 on page 76
0x212	I2C_SLAVE__DEVICE_ADDRESS	Section 6.2.55 on page 76
0x2A3	INTERLEAVED_MODE__ENABLE	Section 6.2.56 on page 77

6.2 Register descriptions

6.2.1 IDENTIFICATION__MODEL_ID

7	6	5	4	3	2	1	0
identification__model_id							
R/W							

Address: 0x000

Type: R/W

Reset: 0xB4

Description:

[7:0]	identification__model_id: Device model identification number. 0xB4 = VL6180X
-------	--

6.2.2 IDENTIFICATION__MODEL_REV_MAJOR

7	6	5	4	3	2	1	0
RESERVED					identification__model_rev_major		
R					R/W		

Address: 0x001

Type: R/W

Reset: 0x1, register default overwritten at boot-up by NVM contents.

Description:

[2:0]	identification__model_rev_major: Revision identifier of the Device for major change.
-------	--

6.2.3 IDENTIFICATION__MODEL_REV_MINOR

7	6	5	4	3	2	1	0
RESERVED					identification__model_rev_minor		
R					R/W		

Address: 0x002

Type: R/W

Reset: 0x3, register default overwritten at boot-up by NVM contents.

Description:

[2:0]	identification__model_rev_minor: Revision identifier of the Device for minor change. IDENTIFICATION__MODEL_REV_MINOR = 3 for latest ROM revision
-------	---

6.2.4 IDENTIFICATION__MODULE_REV_MAJOR

7	6	5	4	3	2	1	0
RESERVED					identification__module_rev_major		
R					R/W		

Address: 0x003

Type: R/W

Reset: 0x1, register default overwritten at boot-up by NVM contents.

Description:

[2:0]	identification__module_rev_major: Revision identifier of the Module Package for major change. Used to store NVM content version. Contact ST for current information.
-------	--

6.2.5 IDENTIFICATION__MODULE_REV_MINOR

7	6	5	4	3	2	1	0
RESERVED					identification__module_rev_minor		
R					R/W		

Address: 0x004

Type: R/W

Reset: 0x2, register default overwritten at boot-up by NVM contents.

Description:

[2:0]	identification__module_rev_minor: Revision identifier of the Module Package for minor change. Used to store NVM content version. Contact ST for current information.
-------	--

6.2.6 IDENTIFICATION__DATE_HI

7	6	5	4	3	2	1	0
identification__year				identification__month			
R/W				R/W			

Address: 0x006

Type: R/W

Reset: 0xYY, register default overwritten at boot-up by NVM contents.

Description: Part of the register set that can be used to uniquely identify a module.

[7:4]	identification__year: Last digit of manufacturing year (bits[3:0]).
[3:0]	identification__month: Manufacturing month (bits[3:0]).

6.2.7 IDENTIFICATION__DATE_LO

7	6	5	4	3	2	1	0
identification__day				identification__phase			
R/W				R/W			

Address: 0x007

Type: R/W

Reset: 0xYY, register default overwritten at boot-up by NVM contents.

Description: Part of the register set that can be used to uniquely identify a module.

[7:3]	identification__day: Manufacturing day (bits[4:0]).
[2:0]	identification__phase: Manufacturing phase identification (bits[2:0]).

6.2.8 IDENTIFICATION__TIME

15	14	13	12	11	10	9	8	7	6	5	4	3	2	1	0
identification__time															
R/W															

Address: 0x008:0x009

Type: R/W

Reset: 0xYYYY, register default overwritten at boot-up by NVM contents.

Description: Part of the register set that can be used to uniquely identify a module.

[15:0]	identification__time: Time since midnight (in seconds) = register_value * 2
--------	---

6.2.9 SYSTEM__MODE_GPIO0

7	6	5	4	3	2	1	0
RESERVED	system__gpio0_is_xshutdown	system__gpio0_polarity	system__gpio0_select			RESERVED	
R	R/W	R/W	R/W			R/W	

Address: 0x010

Type: R/W

Reset: 0x60

Description:

[6]	system__gpio0_is_xshutdown: Priority mode - when enabled, other bits of the register are ignored. GPIO0 is main XSHUTDOWN input. 0: Disabled 1: Enabled - GPIO0 is main XSHUTDOWN input.
[5]	system__gpio0_polarity: Signal Polarity Selection. 0: Active-low 1: Active-high
[4:1]	system__gpio0_select: Functional configuration options. 0000: OFF (Hi-Z) 1000: GPIO Interrupt output
[0]	Reserved. Write 0.

6.2.10 SYSTEM__MODE_GPIO1

7	6	5	4	3	2	1	0
RESERVED		system__gpio1_polarity	system__gpio1_select				RESERVED
R		R/W	R/W				R/W

Address: 0x011

Type: R/W

Reset: 0x20

Description:

[5]	system__gpio1_polarity: Signal Polarity Selection. 0: Active-low 1: Active-high
[4:1]	system__gpio1_select: Functional configuration options. 0000: OFF (Hi-Z) 1000: GPIO Interrupt output
[0]	Reserved. Write 0.

6.2.11 SYSTEM__HISTORY_CTRL

7	6	5	4	3	2	1	0
RESERVED					system__history_buffer_clear	system__history_buffer_mode	system__history_buffer_enable
R					R/W	R/W	R/W

Address: 0x012

Type: R/W

Reset: 0x0

Description:

[2]	system__history_buffer_clear: User-command to clear history (FW will auto-clear this bit when clear has completed). 0: Disabled 1: Clear all history buffers
[1]	system__history_buffer_mode: Select mode buffer results for: 0: Ranging (stores the last 8 ranging values (8-bit)) 1: ALS (stores the last 8 ALS values (16-bit))
[0]	system__history_buffer_enable: Enable History buffering. 0: Disabled 1: Enabled

6.2.12 SYSTEM_INTERRUPT_CONFIG_GPIO

7	6	5	4	3	2	1	0
RESERVED		als_int_mode			range_int_mode		
R		R/W			R/W		

Address: 0x014

Type: R/W

Reset: 0x0

Description:

[5:3]	als_int_mode: Interrupt mode source for ALS readings: 0: Disabled 1: Level Low (value < thresh_low) 2: Level High (value > thresh_high) 3: Out Of Window (value < thresh_low OR value > thresh_high) 4: New sample ready
[2:0]	range_int_mode: Interrupt mode source for Range readings: 0: Disabled 1: Level Low (value < thresh_low) 2: Level High (value > thresh_high) 3: Out Of Window (value < thresh_low OR value > thresh_high) 4: New sample ready

6.2.13 SYSTEM_INTERRUPT_CLEAR

7	6	5	4	3	2	1	0
RESERVED					int_clear_sig		
R					R/W		

Address: 0x015

Type: R/W

Reset: 0x0

Description:

[2:0]	int_clear_sig: Interrupt clear bits. Writing a 1 to each bit will clear the intended interrupt. Bit [0] - Clear Range Int Bit [1] - Clear ALS Int Bit [2] - Clear Error Int.
-------	---

6.2.14 SYSTEM_FRESH_OUT_OF_RESET

7	6	5	4	3	2	1	0
RESERVED							fresh_out_of_reset
R							R/W

Address: 0x016

Type: R/W

Reset: 0x1

Description:

[0]	fresh_out_of_reset: Fresh out of reset bit, default of 1, user can set this to 0 after initial boot and can therefore use this to check for a reset condition
-----	---

6.2.15 SYSTEM_GROUPED_PARAMETER_HOLD

7	6	5	4	3	2	1	0
RESERVED							grouped_parameter_hold
R							R/W

Address: 0x017

Type: R/W

Reset: 0x0

Description:

[0]	<p>grouped_parameter_hold: Flag set over I²C to indicate that data is being updated</p> <p>0: Data is stable - FW is safe to copy</p> <p>1: Data being updated - FW not safe to copy</p> <p>Usage: set to 0x01 first, write any of the registers listed below, then set to 0x00 so that the settings are used by the firmware at the start of the next measurement.</p> <p>SYSTEM_INTERRUPT_CONFIG_GPIO</p> <p>SYSRANGE_THRESH_HIGH</p> <p>SYSRANGE_THRESH_LOW</p> <p>SYSALS_INTEGRATION_PERIOD</p> <p>SYSALS_ANALOGUE_GAIN</p> <p>SYSALS_THRESH_HIGH</p> <p>SYSALS_THRESH_LOW</p>
-----	---

6.2.16 SYSRANGE__START

7	6	5	4	3	2	1	0
RESERVED						sysrange__mode_select	sysrange__startstop
R						R/W	R/W

Address: 0x018**Type:** R/W**Reset:** 0x0**Description:**

[1]	sysrange__mode_select: Device Mode select 0: Ranging Mode Single-Shot 1: Ranging Mode Continuous
[0]	sysrange__startstop: StartStop trigger based on current mode and system configuration of device_ready. FW clears register automatically. Setting this bit to 1 in single-shot mode starts a single measurement. Setting this bit to 1 in continuous mode will either start continuous operation (if stopped) or halt continuous operation (if started). This bit is auto-cleared in both modes of operation.

6.2.17 SYSRANGE__THRESH_HIGH

7	6	5	4	3	2	1	0
sysrange__thresh_high							
R/W							

Address: 0x019**Type:** R/W**Reset:** 0xFF**Description:**

[7:0]	sysrange__thresh_high: High Threshold value for ranging comparison. Range 0-255mm.
-------	--

6.2.18 SYSRANGE__THRESH_LOW

7	6	5	4	3	2	1	0
sysrange__thresh_low							
R/W							

Address: 0x01A

Type: R/W

Reset: 0x0

Description:

[7:0]	sysrange__thresh_low: Low Threshold value for ranging comparison. Range 0-255mm.
-------	--

6.2.19 SYSRANGE__INTERMEASUREMENT_PERIOD

7	6	5	4	3	2	1	0
sysrange__intermeasurement_period							
R/W							

Address: 0x01B

Type: R/W

Reset: 0xFF

Description:

[7:0]	sysrange__intermeasurement_period: Time delay between measurements in Ranging continuous mode. Range 0-254 (0 = 10ms). Step size = 10ms.
-------	--

6.2.20 SYSRANGE__MAX_CONVERGENCE_TIME

7	6	5	4	3	2	1	0
RESERVED		sysrange__max_convergence_time					
R		R/W					

Address: 0x01C

Type: R/W

Reset: 0x31

Description:

[5:0]	sysrange__max_convergence_time: Maximum time to run measurement in Ranging modes. Range 1 - 63 ms (1 code = 1 ms); Measurement aborted when limit reached to aid power reduction. For example, 0x01 = 1ms, 0x0a = 10ms. Note: Effective max_convergence_time depends on readout_averaging_sample_period setting.
-------	---

6.2.21 SYSRANGE__CROSSTALK_COMPENSATION_RATE

15	14	13	12	11	10	9	8	7	6	5	4	3	2	1	0
sysrange__crosstalk_compensation_rate															
R/W															

Address: 0x01E**Type:** R/W**Reset:** 0x0**Description:**

[15:0]	sysrange__crosstalk_compensation_rate: User-controlled crosstalk compensation in Mcps (9.7 format).
--------	---

6.2.22 SYSRANGE__CROSSTALK_VALID_HEIGHT

7	6	5	4	3	2	1	0
sysrange__crosstalk_valid_height							
R/W							

Address: 0x021**Type:** R/W**Reset:** 0x14**Description:**

[7:0]	sysrange__crosstalk_valid_height: Minimum range value in mm to qualify for cross-talk compensation.
-------	---

6.2.23 SYSRANGE__EARLY_CONVERGENCE_ESTIMATE

15	14	13	12	11	10	9	8	7	6	5	4	3	2	1	0
sysrange__early_convergence_estimate															
R/W															

Address: 0x022**Type:** R/W**Reset:** 0x0**Description:**

[15:0]	FW carries out an estimate of convergence rate 0.5ms into each new range measurement. If convergence rate is below user input value, the operation aborts to save power. Note: This register must be configured otherwise ECE should be disabled via SYSRANGE__RANGE_CHECK_ENABLES.
--------	--

6.2.24 SYSRANGE__PART_TO_PART_RANGE_OFFSET

7	6	5	4	3	2	1	0
sysrange__part_to_part_range_offset							
R/W							

Address: 0x024
Type: R/W
Reset: 0xYY, register default overwritten at boot-up by NVM contents.

Description:

[7:0]	sysrange__part_to_part_range_offset: 2s complement format.
-------	--

6.2.25 SYSRANGE__RANGE_IGNORE_VALID_HEIGHT

7	6	5	4	3	2	1	0
sysrange__range_ignore_valid_height							
R/W							

Address: 0x025
Type: R/W
Reset: 0x0, register default overwritten at boot-up by NVM contents.

Description:

[7:0]	sysrange__range_ignore_valid_height: Range below which ignore threshold is applied. Aim is to ignore the cover glass i.e. low signal rate at near distance. Should not be applied to low reflectance target at far distance. Range in mm. Note: It is recommended to set this register to 255 if the range ignore feature is used.
-------	---

6.2.26 SYSRANGE__RANGE_IGNORE_THRESHOLD

15	14	13	12	11	10	9	8	7	6	5	4	3	2	1	0
sysrange__range_ignore_threshold															
R/W															

Address: 0x026
Type: R/W
Reset: 0x00

Description:

[15:0]	sysrange__range_ignore_threshold: User configurable min threshold signal return rate. Used to filter out ranging due to cover glass when there is no target above the device. Mcps 9.7 format. Note: Register must be initialized if this feature is used.
--------	---

6.2.27 SYSRANGE__MAX_AMBIENT_LEVEL_MULT

7	6	5	4	3	2	1	0
sysrange__max_ambient_level_mult							
R/W							

Address: 0x02C

Type: R/W

Reset: 0xA0, register default overwritten at boot-up by NVM contents.

Description:

[7:0]	sysrange__max_ambient_level_mult: User input value to multiply return_signal_count for AMB:signal ratio check. If (amb counts * 6) > return_signal_count * mult then abandon measurement due to high ambient (4.4 format).
-------	--

6.2.28 SYSRANGE__RANGE_CHECK_ENABLES

7	6	5	4	3	2	1	0
RESERVED			sysrange__signal_to_noise_enable	0	0	sysrange__range_ignore_enable	sysrange__early_convergence_enable
R			R/W	R/W	R	R/W	R/W

Address: 0x02D

Type: R/W

Reset: 0x11, register default overwritten at boot-up by NVM contents.

Description:

[4]	sysrange__signal_to_noise_enable: Measurement enable/disable
[1]	sysrange__range_ignore_enable: Measurement enable/disable
[0]	sysrange__early_convergence_enable: Measurement enable/disable

6.2.29 SYSRANGE__VHV_RECALIBRATE

7	6	5	4	3	2	1	0
RESERVED						sysrange__vhw_status	sysrange__vhw_recalibrate
R						R/W	R/W

Address: 0x02E

Type: R/W

Reset: 0x0

Description:

[1]	sysrange__vhw_status: FW controlled status bit showing when FW has completed auto-vhw process. 0: FW has finished autoVHV operation 1: During autoVHV operation
[0]	sysrange__vhw_recalibrate: User-Controlled enable bit to force FW to carry out recalibration of the VHV setting for sensor array. FW clears bit after operation carried out. 0: Disabled 1: Manual trigger for VHV recalibration. Can only be called when ALS and ranging are in STOP mode

6.2.30 SYSRANGE__VHV_REPEAT_RATE

7	6	5	4	3	2	1	0
sysrange__vhw_repeate_rate							
R/W							

Address: 0x031

Type: R/W

Reset: 0x0

Description:

[7:0]	sysrange__vhw_repeat_rate: User entered repeat rate of auto VHV task (0 = off, 255 = after every 255 measurements)
-------	--

6.2.31 SYSALS__START

7	6	5	4	3	2	1	0
RESERVED						sysals__mode_select	sysals__startstop
R						R/W	R/W

Address: 0x038

Type: R/W

Reset: 0x0

Description:

[1]	sysals__mode_select: Device Mode select 0: ALS Mode Single-Shot 1: ALS Mode Continuous
[0]	sysals__startstop: Start/Stop trigger based on current mode and system configuration of device_ready. FW clears register automatically. Setting this bit to 1 in single-shot mode starts a single measurement. Setting this bit to 1 in continuous mode will either start continuous operation (if stopped) or halt continuous operation (if started). This bit is auto-cleared in both modes of operation. See 6.2.56: INTERLEAVED_MODE__ENABLE for combined ALS and Range operation.

6.2.32 SYSALS__THRESH_HIGH

15	14	13	12	11	10	9	8	7	6	5	4	3	2	1	0
sysals__thresh_high															
R/W															

Address: 0x03A

Type: R/W

Reset: 0xFFFF

Description:

[15:0]	sysals__thresh_high: High Threshold value for ALS comparison. Range 0-65535 codes.
--------	--

6.2.33 SYSALS__THRESH_LOW

15	14	13	12	11	10	9	8	7	6	5	4	3	2	1	0
sysals__thresh_low															
R/W															

Address: 0x03C

Type: R/W

Reset: 0x0

Description:

[15:0]	sysals__thresh_low: Low Threshold value for ALS comparison. Range 0-65535 codes.
--------	--

6.2.34 SYSALS__INTERMEASUREMENT_PERIOD

7	6	5	4	3	2	1	0
sysals__intermeasurement_period							
R/W							

Address: 0x03E

Type: R/W

Reset: 0xFF

Description:

[7:0]	sysals__intermeasurement_period: Time delay between measurements in ALS continuous mode. Range 0-254 (0 = 10ms). Step size = 10ms.
-------	--

6.2.35 SYSALS__ANALOGUE_GAIN

7	6	5	4	3	2	1	0
RESERVED					sysals__analogue_gain_light		
R					R/W		

Address: 0x03F**Type:** R/W**Reset:** 0x06**Description:**

[2:0]	sysals__analogue_gain_light: ALS analogue gain (light channel) 0: ALS Gain = 20 1: ALS Gain = 10 2: ALS Gain = 5.0 3: ALS Gain = 2.5 4: ALS Gain = 1.67 5: ALS Gain = 1.25 6: ALS Gain = 1.0 7: ALS Gain = 40 Controls the "light" channel gain. Note: Upper nibble should be set to 0x4 i.e. For ALS gain of 1.0 write 0x46.
-------	---

6.2.36 SYSALS__INTEGRATION_PERIOD

15	14	13	12	11	10	9	8	7	6	5	4	3	2	1	0
RESERVED								sysals__integration_period							
R								R/W							

Address: 0x040**Type:** R/W**Reset:** 0x0**Description:**

[8:0]	sysals__integration_period: Integration period for ALS mode. 1 code = 1 ms (0 = 1 ms). Recommended setting is 100 ms (0x63).
-------	---

6.2.37 RESULT__RANGE_STATUS

7	6	5	4	3	2	1	0
result__range_error_code				result__range_min_threshold_hit	result__range_max_threshold_hit	result__range_measurement_ready	result__range_device_ready
R				R	R	R	R

Address: 0x04D

Type: R

Reset: 0x1

Description:

[7:4]	result__range_error_code: Specific error codes 0000: No error 0001: VCSEL Continuity Test 0010: VCSEL Watchdog Test 0011: VCSEL Watchdog 0100: PLL1 Lock 0101: PLL2 Lock 0110: Early Convergence Estimate 0111: Max Convergence 1000: No Target Ignore 1001: Not used 1010: Not used 1011: Max Signal To Noise Ratio 1100: Raw Ranging Algo Underflow 1101: Raw Ranging Algo Overflow 1110: Ranging Algo Underflow 1111: Ranging Algo Overflow
[3]	result__range_min_threshold_hit: Legacy register - DO NOT USE Use instead 6.2.39: RESULT__INTERRUPT_STATUS_GPIO
[2]	result__range_max_threshold_hit: Legacy register - DO NOT USE Use instead 6.2.39: RESULT__INTERRUPT_STATUS_GPIO
[1]	result__range_measurement_ready: Legacy register - DO NOT USE Use instead 6.2.39: RESULT__INTERRUPT_STATUS_GPIO
[0]	result__range_device_ready: Device Ready. When set to 1, indicates the device mode and configuration can be changed and a new start command will be accepted. When 0, indicates the device is busy.

6.2.38 RESULT__ALS_STATUS

7	6	5	4	3	2	1	0
result__als_error_code				result__als_min_threshold_hit	result__als_max_threshold_hit	result__als_measurement_ready	result__als_device_ready
R				R	R	R	R

Address: 0x04E

Type: R

Reset: 0x1

Description:

[7:4]	result__als_error_code: Specific error and debug codes 0000: No error 0001: Overflow error 0002: Underflow error
[3]	result__als_min_threshold_hit: Legacy register - DO NOT USE Use instead 6.2.39: RESULT__INTERRUPT_STATUS_GPIO
[2]	result__als_max_threshold_hit: Legacy register - DO NOT USE Use instead 6.2.39: RESULT__INTERRUPT_STATUS_GPIO
[1]	result__als_measurement_ready: Legacy register - DO NOT USE Use instead 6.2.39: RESULT__INTERRUPT_STATUS_GPIO
[0]	result__als_device_ready: Device Ready. When set to 1, indicates the device mode and configuration can be changed and a new start command will be accepted. When 0, indicates the device is busy.

6.2.39 RESULT_INTERRUPT_STATUS_GPIO

7	6	5	4	3	2	1	0
result_int_error_gpio		result_int_als_gpio			result_int_range_gpio		
R		R			R		

Address: 0x04F

Type: R

Reset: 0x0

Description:

[7:6]	result_int_error_gpio: Interrupt bits for Error: 0: No error reported 1: Laser Safety Error 2: PLL error (either PLL1 or PLL2)
[5:3]	result_int_als_gpio: Interrupt bits for ALS: 0: No threshold events reported 1: Level Low threshold event 2: Level High threshold event 3: Out Of Window threshold event 4: New Sample Ready threshold event
[2:0]	result_int_range_gpio: Interrupt bits for Range: 0: No threshold events reported 1: Level Low threshold event 2: Level High threshold event 3: Out Of Window threshold event 4: New Sample Ready threshold event

6.2.40 RESULT_ALS_VAL

15	14	13	12	11	10	9	8	7	6	5	4	3	2	1	0
result_als_ambient_light															
R															

Address: 0x050

Type: R

Reset: 0x0

Description:

[15:0]	result_als_ambient_light: 16 Bit ALS count output value. Lux value depends on Gain and integration settings and calibrated lux/count setting.
--------	---

6.2.41 RESULT__HISTORY_BUFFER_x

	15	14	13	12	11	10	9	8	7	6	5	4	3	2	1	0
RESULT__HISTORY_BUFFER_0	result__history_buffer_0															
RESULT__HISTORY_BUFFER_1	result__history_buffer_1															
RESULT__HISTORY_BUFFER_2	result__history_buffer_2															
RESULT__HISTORY_BUFFER_3	result__history_buffer_3															
RESULT__HISTORY_BUFFER_4	result__history_buffer_4															
RESULT__HISTORY_BUFFER_5	result__history_buffer_5															
RESULT__HISTORY_BUFFER_6	result__history_buffer_6															
RESULT__HISTORY_BUFFER_7	result__history_buffer_7															
	R															

Address: 0x052 + x * 0x2 (x=0 to 7)

Type: R

Reset: 0x0

Description: See also [6.2.11: SYSTEM__HISTORY_CTRL](#)

RESULT__HISTORY_BUFFER_0: [15:0]	result__history_buffer_0: Range/ALS result value. Range mode; Bits[15:8] range_val_latest; Bits[7:0] range_val_d1; ALS mode; Bits[15:0] als_val_latest
RESULT__HISTORY_BUFFER_1: [15:0]	result__history_buffer_1: Range/ALS result value. Range mode; Bits[15:8] range_val_d2; Bits[7:0] range_val_d3; ALS mode; Bits[15:0] als_val_d1
RESULT__HISTORY_BUFFER_2: [15:0]	result__history_buffer_2: Range/ALS result value. Range mode; Bits[15:8] range_val_d4; Bits[7:0] range_val_d5; ALS mode; Bits[15:0] als_val_d2
RESULT__HISTORY_BUFFER_3: [15:0]	result__history_buffer_3: Range/ALS result value. Range mode; Bits[15:8] range_val_d6; Bits[7:0] range_val_d7; ALS mode; Bits[15:0] als_val_d3
RESULT__HISTORY_BUFFER_4: [15:0]	result__history_buffer_4: Range/ALS result value. Range mode; Bits[15:8] range_val_d8; Bits[7:0] range_val_d9; ALS mode; Bits[15:0] als_val_d4
RESULT__HISTORY_BUFFER_5: [15:0]	result__history_buffer_5: Range/ALS result value. Range mode; Bits[15:8] range_val_d10; Bits[7:0] range_val_d11; ALS mode; Bits[15:0] als_val_d5
RESULT__HISTORY_BUFFER_6: [15:0]	result__history_buffer_6: Range/ALS result value. Range mode; Bits[15:8] range_val_d12; Bits[7:0] range_val_d13; ALS mode; Bits[15:0] als_val_d6
RESULT__HISTORY_BUFFER_7: [15:0]	result__history_buffer_7: Range/ALS result value. Range mode; Bits[15:8] range_val_d14; Bits[7:0] range_val_d15; ALS mode; Bits[15:0] als_val_d7

6.2.42 RESULT__RANGE_VAL

7	6	5	4	3	2	1	0
result__range_val							
R							

Address: 0x062

Type: R

Reset: 0x0

Description:

[7:0]	result__range_val: Final range result value presented to the user for use. Unit is in mm.
-------	---

6.2.43 RESULT__RANGE_RAW

7	6	5	4	3	2	1	0
result__range_raw							
R							

Address: 0x064

Type: R

Reset: 0x0

Description:

[7:0]	result__range_raw: Raw Range result value with offset applied (no cross-talk compensation applied). Unit is in mm.
-------	--

6.2.44 RESULT__RANGE_RETURN_RATE

15	14	13	12	11	10	9	8	7	6	5	4	3	2	1	0
result__range_return_rate															
R															

Address: 0x066

Type: R

Reset: 0x0

Description:

[15:0]	result__range_return_rate: sensor count rate of signal returns correlated to IR emitter. Computed from RETURN_SIGNAL_COUNT / RETURN_CONV_TIME. Mcps 9.7 format
--------	--

6.2.45 RESULT__RANGE_REFERENCE_RATE

15	14	13	12	11	10	9	8	7	6	5	4	3	2	1	0
result__range_reference_rate															
R															

Address: 0x068

Type: R

Reset: 0x0

Description:

[15:0]	result__range_reference_rate: sensor count rate of reference signal returns. Computed from REFERENCE_SIGNAL_COUNT / RETURN_CONV_TIME. Mcps 9.7 format Note: Both arrays converge at the same time, so using the return array convergence time is correct.
--------	--

6.2.46 RESULT__RANGE_RETURN_SIGNAL_COUNT

31	30	29	28	27	26	25	24	23	22	21	20	19	18	17	16	15	14	13	12	11	10	9	8	7	6	5	4	3	2	1	0		
result__range_return_signal_count																																	
R																																	

Address: 0x06C

Type: R

Reset: 0x0

Description:

[31:0]	result__range_return_signal_count: sensor count output value attributed to signal correlated to IR emitter on the Return array.
--------	---

6.2.47 RESULT__RANGE_REFERENCE_SIGNAL_COUNT

31	30	29	28	27	26	25	24	23	22	21	20	19	18	17	16	15	14	13	12	11	10	9	8	7	6	5	4	3	2	1	0
result__range_reference_signal_count																															
R																															

Address: 0x070

Type: R

Reset: 0x0

Description:

[31:0]	result__range_reference_signal_count: sensor count output value attributed to signal correlated to IR emitter on the Reference array.
--------	---

6.2.48 RESULT__RANGE_RETURN_AMB_COUNT

31	30	29	28	27	26	25	24	23	22	21	20	19	18	17	16	15	14	13	12	11	10	9	8	7	6	5	4	3	2	1	0
result__range_return_amb_count																															
R																															

Address: 0x074

Type: R

Reset: 0x0

Description:

[31:0]	result__range_return_amb_count: sensor count output value attributed to uncorrelated ambient signal on the Return array. Must be multiplied by 6 if used to calculate the ambient to signal threshold.
--------	--

6.2.49 RESULT__RANGE_REFERENCE_AMB_COUNT

31	30	29	28	27	26	25	24	23	22	21	20	19	18	17	16	15	14	13	12	11	10	9	8	7	6	5	4	3	2	1	0
result__range_reference_amb_count																															
R																															

Address: 0x078

Type: R

Reset: 0x0

Description:

[31:0]	result__range_reference_amb_count: sensor count output value attributed to uncorrelated ambient signal on the Reference array.
--------	--

6.2.50 RESULT__RANGE_RETURN_CONV_TIME

31	30	29	28	27	26	25	24	23	22	21	20	19	18	17	16	15	14	13	12	11	10	9	8	7	6	5	4	3	2	1	0
result__range_return_conv_time																															
R																															

Address: 0x07C

Type: R

Reset: 0x0

Description:

[31:0]	result__range_return_conv_time: sensor count output value attributed to signal on the Return array.
--------	---

6.2.51 RESULT__RANGE_REFERENCE_CONV_TIME

31	30	29	28	27	26	25	24	23	22	21	20	19	18	17	16	15	14	13	12	11	10	9	8	7	6	5	4	3	2	1	0
result__range_reference_conv_time																															
R																															

Address: 0x080

Type: R

Reset: 0x0

Description:

[31:0]	result__range_reference_conv_time: sensor count output value attributed to signal on the Reference array.
--------	---

6.2.52 READOUT__AVERAGING_SAMPLE_PERIOD

7	6	5	4	3	2	1	0
readout__averaging_sample_period							
R/W							

Address: 0x10A

Type: R/W

Reset: 0x30

Description:

[7:0]	readout__averaging_sample_period: The internal readout averaging sample period can be adjusted from 0 to 255. Increasing the sampling period decreases noise but also reduces the effective max convergence time and increases power consumption: Effective max convergence time = max convergence time - readout averaging period (see Section 2.7.1: Range timing). Each unit sample period corresponds to around 64.5 μs additional processing time. The recommended setting is 48 which equates to around 4.3 ms.
-------	---

6.2.53 FIRMWARE__BOOTUP

7	6	5	4	3	2	1	0
RESERVED							firmware__bootup
R							R/W

Address: 0x119

Type: R/W

Reset: 0x1

Description:

[0]	firmware__bootup: FW must set bit once initial boot has been completed.
-----	---

6.2.54 FIRMWARE__RESULT_SCALER

7	6	5	4	3	2	1	0
RESERVED				firmware__als_result_scaler			
R				R/W			

Address: 0x120

Type: R/W

Reset: 0x1

Description:

[3:0]	firmware__als_result_scaler: Bits [3:0] analogue gain 1 to 16x
-------	--

6.2.55 I2C_SLAVE__DEVICE_ADDRESS

7	6	5	4	3	2	1	0
RESERVED	super_i2c_slave__device_address						
R	R/W						

Address: 0x212

Type: R/W

Reset: 0x29

Description:

[6:0]	super_i2c_slave__device_address: User programmable I ² C address (7-bit). Device address can be re-designated after power-up.
-------	--

6.2.56 INTERLEAVED_MODE_ENABLE

7	6	5	4	3	2	1	0
interleaved_mode_enable							
R/W							

Address: 0x2A3**Type:** R/W**Reset:** 0x0**Description:**

[7:0]	Interleaved mode enable: Write 0x1 to this register to select ALS+Range interleaved mode. Use SYSALS__START and SYSALS__INTERMEASUREMENT_PERIOD to control this mode. A range measurement is automatically performed immediately after each ALS measurement.
-------	--

7 Outline drawing

Figure 37. Outline drawing (page 1/2)

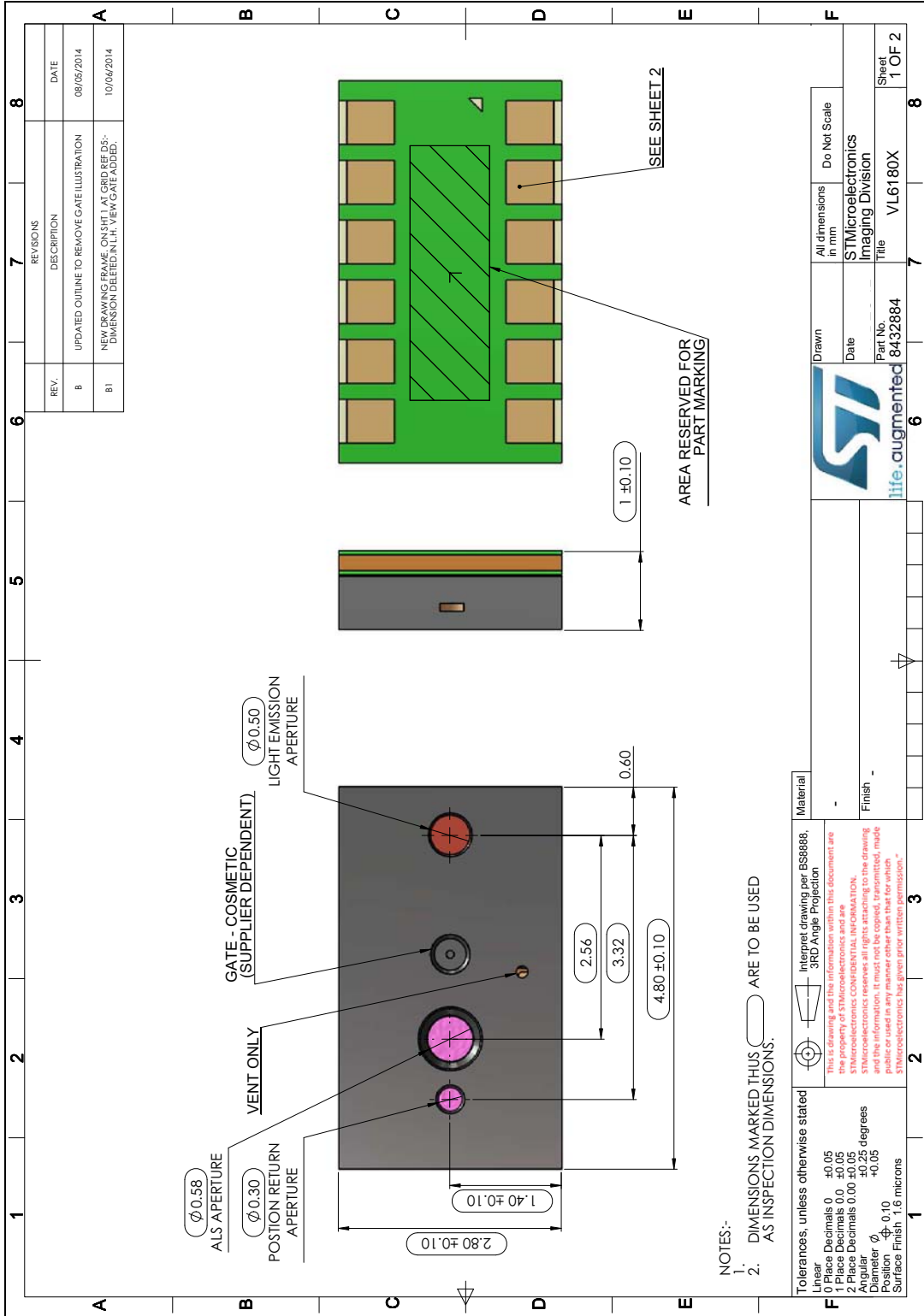
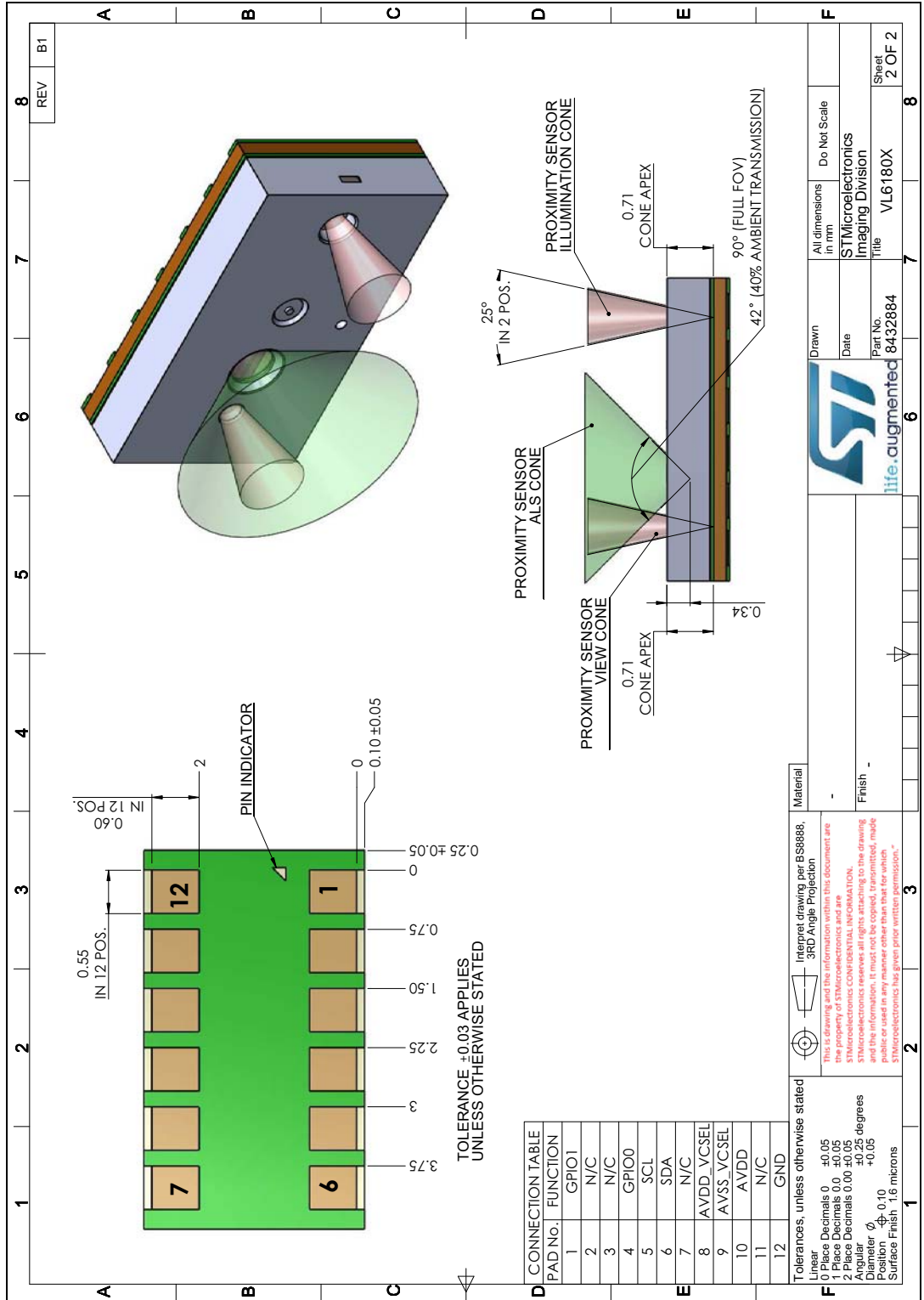

Figure 38. Outline drawing (page 2/2)



8 Laser safety considerations

The VL6180X contains a laser emitter and corresponding drive circuitry. The laser output is designed to remain within Class 1 laser safety limits under all reasonably foreseeable conditions including single faults in compliance with IEC 60825-1:2007. The laser output will remain within Class 1 limits as long as the STMicroelectronics recommended device settings are used and the operating conditions specified in this datasheet are respected. The laser output power must not be increased by any means and no optics should be used with the intention of focusing the laser beam.

Figure 39. Class 1 laser product label



8.1 Compliance

Complies with 21 CFR 1040.10 and 1040.11 except for deviations pursuant to Laser Notice No.50, dated June 24, 2007.

9 Ordering information

VL6180X is currently available in the following format. More detailed information is available on request.

Table 29. Delivery format

Order code	Description
VL6180XV0NR/1	Tape and reel (5000 units in a reel)

9.1 Traceability and identification

Latest ROM revision can be identified as follows:

0x002 IDENTIFICATION__MODEL_REV_MINOR = 3

The minimum information required for traceability is the content of the following registers:

0x006 - IDENTIFICATION__DATE_HI

0x007 - IDENTIFICATION__DATE_LO

0x008 - IDENTIFICATION__TIME (16-bit)

0x00A - IDENTIFICATION__CODE

With this information, the module can be uniquely identified.

Preferably, all the IDENTIFICATION register contents should be provided for traceability.

9.2 Part marking

Devices are marked on the underside as shown below. 1st line is the product ID. 2nd line is the manufacturing info. (circled in green), where the 1st four letters are the lot ID and the last 3 digits are the year + week number. Here: 338 is 2013 wk38. The final letter, circled in red, is the ROM revision ('E').

Figure 40. Part marking

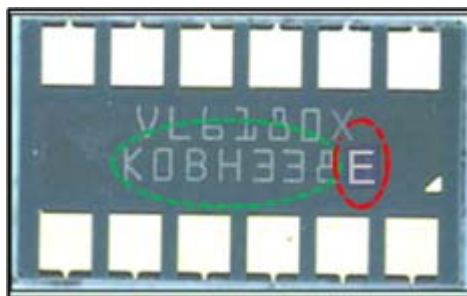

9.3 Packaging

The Root part number 1 is available in tape and reel packaging as shown in [Figure 41](#).

Figure 41. Tape and reel packaging

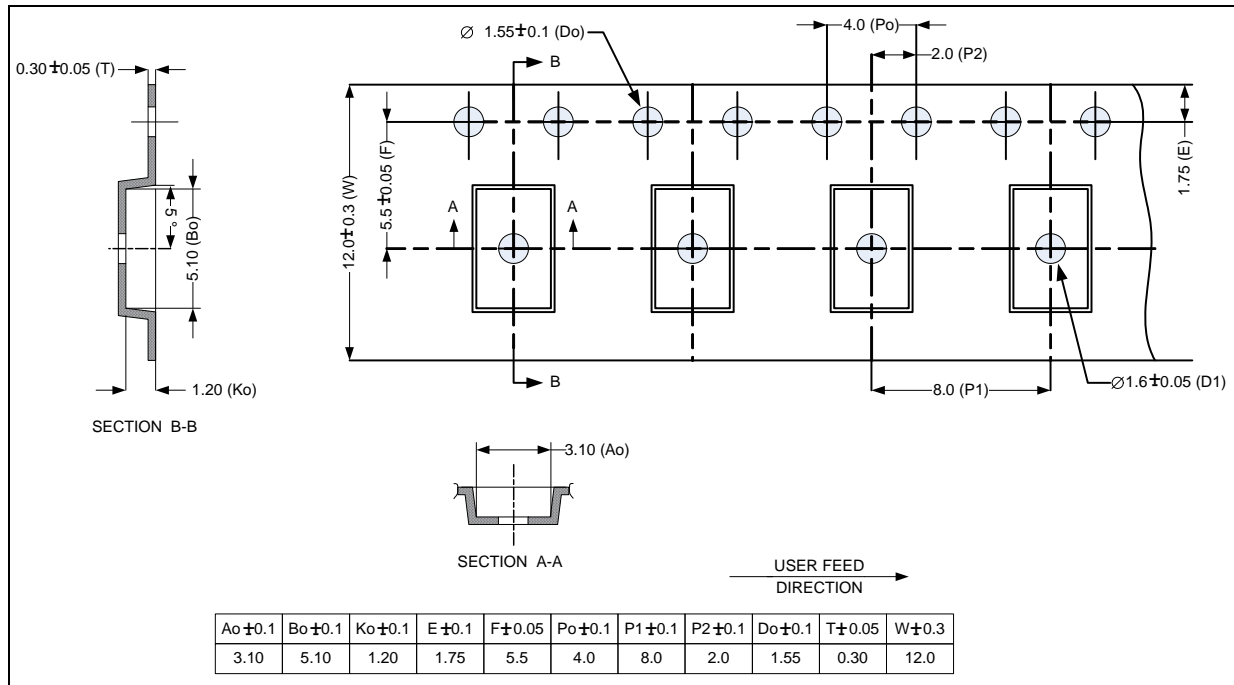

9.3.1 Package labeling

The labeling on the packing carton is shown in [Figure 42](#). The latest ROM revision is indicated alongside the order code (shaded green) and also after the product marking (shaded pink).

Figure 42. Package labeling

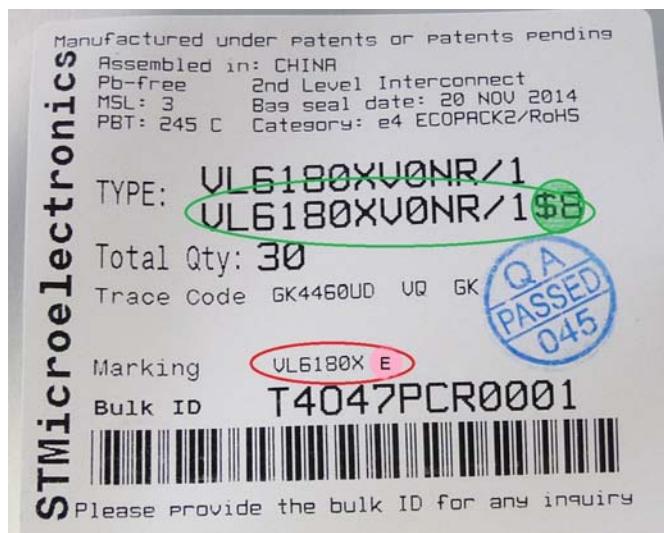

9.4 Storage

The Root part number 1 is a MSL 3 package.

Table 30. Storage conditions

Level	Floor Life (out of bag) at Factory Ambient <30°C/60% RH
3	1 Week

After this limit, dry bake to be done; 3 hours at 125°C.

9.5 ROHS compliance

The Root part number 1 is Ecopack2 compliant as per ST definition.

Devices which are ROHS compliant even with use of ROHS exemption(s) and free of Halogenated flame retardant are named ECOPACK2 devices with the following definition:

- ROHS compliant even with use of ROHS exemption(s)
- 500 ppm maximum of Antimony as oxide or organic compound in each organic assembly material (glue, substrate, mold compounds, housing...). Antimony in ceramic parts, in glass and in solder alloy is not restricted.
- 900 ppm maximum Bromine + Chlorine in each organic assembly materials (glue, substrate, mold compounds, housing...)

These values are referring to maximum total content not to extractable ions content. Purchasing specification of assembly materials can impose lower values for technical reasons.

ECOPACK2 devices are of course fully compliant to ST banned and declarable substances specification and for example cannot contain red Phosphorus flame retardant.

10 ECOPACK®

In order to meet environmental requirements, ST offers these devices in different grades of ECOPACK® packages, depending on their level of environmental compliance. ECOPACK® specifications, grade definitions and product status are available at: www.st.com. ECOPACK® is an ST trademark.

11 Revision history

Table 31. Document revision history

Date	Revision	Changes
23-Sep-2013	1	Initial release.
30-Jan-2014	1.1	General update for latest ROM revision: <i>Section 1.1: Technical specification</i> updated <i>Section 1.4: Typical application schematic</i> updated <i>Section 1.5: Recommended solder pad dimensions</i> updated Notes added to <i>Figure 5.: Recommended reflow profile</i> <i>Section 2.10: Ambient light sensor (ALS)</i> updated. <i>Section 5.1: Absolute maximum ratings</i> added <i>Section 5.2: Normal operating conditions</i> extended <i>Section 4: I2C control interface</i> added Revised outline drawing added to <i>Section 7: Outline drawing</i> Class 1 laser product label added to <i>Section 7: Outline drawing</i> <i>Section 9: Ordering information</i> added information relating to device marking and package labeling
02-Apr-2014	1.2	Updates to the following sections: <i>Section 1.5: Recommended solder pad dimensions</i> <i>Section 5.2: Normal operating conditions</i> <i>Section 5.3: Electrical characteristics</i> <i>Section 3.1: Proximity ranging (0 to 100mm)</i> Added <i>Section 3.2: ALS performance</i> Corrected error codes in <i>Section 6.2.38: RESULT__ALS_STATUS</i> Updated <i>Section 6.2.20: SYSRANGE__MAX_CONVERGENCE_TIME</i> Product code changed to VL6180X
09-Apr-14	2	Add documentation reference number (026171) Update Disclaimer
15-May-14	3	ALS linearity spec updated in <i>Section 3.2: ALS performance</i> Updated some detail in <i>Table 1.: Technical specification</i> Added comment to <i>Section 1.3: Device pinout</i> stating that pins labeled 'no connect' can optionally be connected to ground Added test condition to <i>Section 5.3: Electrical characteristics</i> Errata corrections in <i>6.2.8</i> , <i>6.2.35</i> and <i>6.2.54</i> <i>Section 7: Outline drawing</i> updated (no dimensional changes) Dry bake conditions updated in <i>Section 9.4: Storage</i>
28-May-14	4	Added <i>Section 8.1: Compliance</i>
16-Jun-14	5	Re-write of <i>Section 2: Functional description</i> . <i>Section 6: Device registers</i> : Added introduction and minor corrections <i>Section 7: Outline drawing</i> updated to Rev B1. Supplier dependent gate mark added.

Table 31. Document revision history (continued)

Date	Revision	Changes
20-Aug-2014	6	Updates: Section : Signal-to-noise ratio (SNR) : Clarified SNR calculation. Section 6: Device registers : Corrected a clarified some register descriptions. Typical ranging performance graph updated. Delivery & manufacturing info updated.
16-Mar-2016	7	Updates: - API integrated into datasheet Add: Section 2.7.5: Wrap Around Filter Section 2.7.6: Maximum ranging distance (DMAX) Section 4.1: I2C interface - timing characteristics

IMPORTANT NOTICE – PLEASE READ CAREFULLY

STMicroelectronics NV and its subsidiaries ("ST") reserve the right to make changes, corrections, enhancements, modifications, and improvements to ST products and/or to this document at any time without notice. Purchasers should obtain the latest relevant information on ST products before placing orders. ST products are sold pursuant to ST's terms and conditions of sale in place at the time of order acknowledgement.

Purchasers are solely responsible for the choice, selection, and use of ST products and ST assumes no liability for application assistance or the design of Purchasers' products.

No license, express or implied, to any intellectual property right is granted by ST herein.

Resale of ST products with provisions different from the information set forth herein shall void any warranty granted by ST for such product.

ST and the ST logo are trademarks of ST. All other product or service names are the property of their respective owners.

Information in this document supersedes and replaces information previously supplied in any prior versions of this document.

© 2016 STMicroelectronics – All rights reserved



Компания «ЭлектроПласт» предлагает заключение долгосрочных отношений при поставках импортных электронных компонентов на взаимовыгодных условиях!

Наши преимущества:

- Оперативные поставки широкого спектра электронных компонентов отечественного и импортного производства напрямую от производителей и с крупнейших мировых складов;
- Поставка более 17-ти миллионов наименований электронных компонентов;
- Поставка сложных, дефицитных, либо снятых с производства позиций;
- Оперативные сроки поставки под заказ (от 5 рабочих дней);
- Экспресс доставка в любую точку России;
- Техническая поддержка проекта, помощь в подборе аналогов, поставка прототипов;
- Система менеджмента качества сертифицирована по Международному стандарту ISO 9001;
- Лицензия ФСБ на осуществление работ с использованием сведений, составляющих государственную тайну;
- Поставка специализированных компонентов (Xilinx, Altera, Analog Devices, Intersil, Interpoint, Microsemi, Aeroflex, Peregrine, Syfer, Eurofarad, Texas Instrument, Miteq, Cobham, E2V, MA-COM, Hittite, Mini-Circuits, General Dynamics и др.);

Помимо этого, одним из направлений компании «ЭлектроПласт» является направление «Источники питания». Мы предлагаем Вам помощь Конструкторского отдела:

- Подбор оптимального решения, техническое обоснование при выборе компонента;
- Подбор аналогов;
- Консультации по применению компонента;
- Поставка образцов и прототипов;
- Техническая поддержка проекта;
- Защита от снятия компонента с производства.



Как с нами связаться

Телефон: 8 (812) 309 58 32 (многоканальный)

Факс: 8 (812) 320-02-42

Электронная почта: org@eplast1.ru

Адрес: 198099, г. Санкт-Петербург, ул. Калинина, дом 2, корпус 4, литера А.