



Is Now Part of



**ON Semiconductor®**

To learn more about ON Semiconductor, please visit our website at  
[www.onsemi.com](http://www.onsemi.com)

Please note: As part of the Fairchild Semiconductor integration, some of the Fairchild orderable part numbers will need to change in order to meet ON Semiconductor's system requirements. Since the ON Semiconductor product management systems do not have the ability to manage part nomenclature that utilizes an underscore (\_), the underscore (\_) in the Fairchild part numbers will be changed to a dash (-). This document may contain device numbers with an underscore (\_). Please check the ON Semiconductor website to verify the updated device numbers. The most current and up-to-date ordering information can be found at [www.onsemi.com](http://www.onsemi.com). Please email any questions regarding the system integration to [Fairchild\\_questions@onsemi.com](mailto:Fairchild_questions@onsemi.com).

ON Semiconductor and the ON Semiconductor logo are trademarks of Semiconductor Components Industries, LLC dba ON Semiconductor or its subsidiaries in the United States and/or other countries. ON Semiconductor owns the rights to a number of patents, trademarks, copyrights, trade secrets, and other intellectual property. A listing of ON Semiconductor's product/patent coverage may be accessed at [www.onsemi.com/site/pdf/Patent-Marking.pdf](http://www.onsemi.com/site/pdf/Patent-Marking.pdf). ON Semiconductor reserves the right to make changes without further notice to any products herein. ON Semiconductor makes no warranty, representation or guarantee regarding the suitability of its products for any particular purpose, nor does ON Semiconductor assume any liability arising out of the application or use of any product or circuit, and specifically disclaims any and all liability, including without limitation special, consequential or incidental damages. Buyer is responsible for its products and applications using ON Semiconductor products, including compliance with all laws, regulations and safety requirements or standards, regardless of any support or applications information provided by ON Semiconductor. "Typical" parameters which may be provided in ON Semiconductor data sheets and/or specifications can and do vary in different applications and actual performance may vary over time. All operating parameters, including "Typicals" must be validated for each customer application by customer's technical experts. ON Semiconductor does not convey any license under its patent rights nor the rights of others. ON Semiconductor products are not designed, intended, or authorized for use as a critical component in life support systems or any FDA Class 3 medical devices or medical devices with a same or similar classification in a foreign jurisdiction or any devices intended for implantation in the human body. Should Buyer purchase or use ON Semiconductor products for any such unintended or unauthorized application, Buyer shall indemnify and hold ON Semiconductor and its officers, employees, subsidiaries, affiliates, and distributors harmless against all claims, costs, damages, and expenses, and reasonable attorney fees arising out of, directly or indirectly, any claim of personal injury or death associated with such unintended or unauthorized use, even if such claim alleges that ON Semiconductor was negligent regarding the design or manufacture of the part. ON Semiconductor is an Equal Opportunity/Affirmative Action Employer. This literature is subject to all applicable copyright laws and is not for resale in any manner.

# HCPL0700, HCPL0701, HCPL0730, HCPL0731

## Low Input Current High Gain Split Darlington Optocouplers

Single Channel: HCPL0700, HCPL0701, Dual Channel: HCPL0730, HCPL0731

### Features

- Low input current: 0.5mA
- Superior CTR: 2000%
- Superior CMR – 10 kV/μs
- CTR guaranteed 0°C to 70°C
- U.L. Recognized (file# E90700)
- VDE 0884 recognized (file# 136616)  
– approval pending for HCPL0730/0731
- BSI recognized (file# 8661, 8662)  
– HCPL0700/0701 only

### Applications

- Digital logic ground isolation
- Telephone ring detector
- EIA-RS-232C line receiver
- High common mode noise line receiver
- μP bus isolation
- Current loop receiver

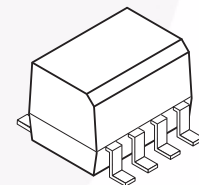
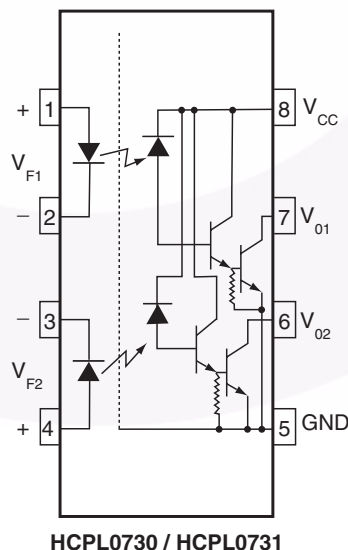
### Description

The HCPL0700, HCPL0701, HCPL0730 and HCPL0731 optocouplers consist of an AlGaAs LED optically coupled to a high gain split darlington photodetector housed in a compact 8-pin small outline package. The HCPL0730 and HCPL0731 devices have two channels per package for optimum mounting density.

The split darlington configuration separating the input photodiode and the first stage gain from the output transistor permits lower output saturation voltage and higher speed operation than possible with conventional darlington phototransistor optocoupler.

The combination of a very low input current of 0.5mA and a high current transfer ratio of 2000% makes this family particularly useful for input interface to MOS, CMOS, LSTTL and EIA RS232C, while output compatibility is ensured to CMOS as well as high fan-out TTL requirements.

### Schematics



### Truth Table

LED	V <sub>O</sub>
ON	LOW
OFF	HIGH

### Absolute Maximum Ratings ( $T_A = 25^\circ\text{C}$ unless otherwise specified)

Stresses exceeding the absolute maximum ratings may damage the device. The device may not function or be operable above the recommended operating conditions and stressing the parts to these levels is not recommended. In addition, extended exposure to stresses above the recommended operating conditions may affect device reliability. The absolute maximum ratings are stress ratings only.

Symbol	Parameter	Value	Units	
$T_{STG}$	Storage Temperature	-40 to +125	$^\circ\text{C}$	
$T_{OPR}$	Operating Temperature	-40 to +85	$^\circ\text{C}$	
	Reflow Temperature Profile (Refer to page 12)			
<b>EMITTER</b>				
$I_F$ (avg)	DC/Average Forward Input Current	20	mA	
$I_F$ (pk)	Peak Forward Input Current (50% duty cycle, 1 ms P.W.)	40	mA	
$I_F$ (trans)	Peak Transient Input Current - ( $\leq 1 \mu\text{s}$ P.W., 300 pps)	1.0	A	
$V_R$	Reverse Input Voltage	5	V	
$P_D$	Input Power Dissipation	35	mW	
<b>DETECTOR</b>				
$I_O$ (avg)	Average Output Current (Pin 6)	60	mA	
$V_{EBR}$	Emitter-Base Reverse Voltage	HCPL0700/HCPL0701	0.5	V
$V_{CC}, V_O$	Supply Voltage, Output Voltage	HCPL0700/HCPL0730	-0.5 to 7	V
		HCPL0701/HCPL0731	-0.5 to 18	
$P_D$	Output power dissipation	100	mW	

**Electrical Characteristics** ( $T_A = 0$  to  $70^\circ\text{C}$  unless otherwise specified)

**Individual Component Characteristics**

Symbol	Parameter	Test Conditions	Device	Min.	Typ.*	Max	Unit	
<b>EMITTER</b>								
$V_F$	Input Forward Voltage	$I_F = 1.6\text{mA}$	$T_A = 25^\circ\text{C}$	HCPL0700/01	1.0	1.25	1.7	V
				HCPL0730/31		1.35		
		All			1.75			
$BV_R$	Input Reverse Breakdown Voltage	$T_A = 25^\circ\text{C}, I_R = 10\mu\text{A}$	All	5.0				
<b>DETECTOR</b>								
$I_{OH}$	Logic High Output Current	$I_F = 0\text{mA}, V_O = V_{CC} = 18\text{V}$	HCPL0701/31		0.01	100	$\mu\text{A}$	
		$I_F = 0\text{mA}, V_O = V_{CC} = 7\text{V}$	HCPL0700/30		0.01	250		
$I_{CCL}$	Logic Low Supply Current	$I_F = 1.6\text{mA}, V_O = \text{Open}, V_{CC} = 18\text{V}$	HCPL0700/01		0.4	1.5	mA	
		$I_{F1} = I_{F2} = 1.6\text{mA}, V_{CC} = 7\text{V}$	HCPL0730		0.8			
		$V_{O1} = V_{O2} = \text{Open}, V_{CC} = 18\text{V}$	HCPL0731		1			
$I_{CCH}$	Logic High Supply Current	$I_F = 0\text{mA}, V_O = \text{Open}, V_{CC} = 18\text{V}$	HCPL0700/01			10	$\mu\text{A}$	
		$I_{F1} = I_{F2} = 0, V_{CC} = 7\text{V}$	HCPL0730		0.001	20		
		$V_{O1} = V_{O2} = \text{Open}, V_{CC} = 18\text{V}$	HCPL0731		0.01			

**Transfer Characteristics**

Symbol	Parameter	Test Conditions	Device	Min.	Typ.*	Max.	Unit
CTR	<b>COUPLED</b> Current Transfer Ratio (Note 1, 2)	$I_F = 0.5\text{mA}, V_O = 0.4\text{V}, V_{CC} = 4.5\text{V}$	HCPL0701/31	400		5000	%
			HCPL0700	300		2600	
			HCPL0701	500		2600	
			HCPL0730	300		5000	
			HCPL0731	500		5000	
$V_{OL}$	Logic Low Output Voltage	$I_F = 0.5\text{mA}, I_O = 2\text{mA}, V_{CC} = 4.5\text{V}$	HCPL0701			0.4	V
		$I_F = 1.6\text{mA}, I_O = 8\text{mA}, V_{CC} = 4.5\text{V}$	HCPL0731			0.4	
		$I_F = 5\text{mA}, I_O = 15\text{mA}, V_{CC} = 4.5\text{V}$				0.4	
		$I_F = 12\text{mA}, I_O = 24\text{mA}, V_{CC} = 4.5\text{V}$				0.4	
		$I_F = 1.6\text{mA}, I_O = 4.8\text{mA}, V_{CC} = 4.5\text{V}$	HCPL0700/0730			0.4	

**Isolation Characteristics**

Symbol	Characteristics	Test Conditions	Min.	Typ.*	Max.	Unit
$I_{I-O}$	Input-Output Insulation Leakage Current	Relative humidity = 45%, $T_A = 25^\circ\text{C}, t = 5\text{ s},$ $V_{I-O} = 3000\text{ VDC}$ (Note 4)			1.0	$\mu\text{A}$
$V_{ISO}$	Withstand Insulation Test Voltage	$R_H \leq 50\%, T_A = 25^\circ\text{C},$ $I_{I-O} \leq 2\mu\text{A}, t = 1\text{ min.}$ (Note 4, 5)	2500			$V_{RMS}$
$R_{I-O}$	Resistance (Input to Output)	$V_{I-O} = 500\text{ VDC}$ (Note 4)		$10^{12}$		$\Omega$

 \*All typicals at  $T_A = 25^\circ\text{C}$

## Electrical Characteristics ( $T_A = 0$ to $70^\circ\text{C}$ unless otherwise specified)

### Switching Characteristics ( $V_{CC} = 5\text{V}$ )

Symbol	Parameter	Test Conditions	Device	Min.	Typ.*	Max.	Unit		
$T_{PHL}$	Propagation Delay Time to Logic Low (Note 2) (Fig. 14)	$R_L = 4.7\text{k}\Omega$ , $I_F = 0.5\text{mA}$ $T_A = 25^\circ\text{C}$	HCPL0701			30	$\mu\text{s}$		
			HCPL0731			120			
			HCPL0701			3		25	
			HCPL0731			5		100	
		$R_L = 270\ \Omega$ , $I_F = 12\text{mA}$ $T_A = 25^\circ\text{C}$	HCPL0701				2		
			HCPL0731				3		
			HCPL0701				0.3	1	
			HCPL0731				0.4	2	
		$R_L = 2.2\ \text{k}\Omega$ , $I_F = 1.6\text{mA}$ $T_A = 25^\circ\text{C}$	HCPL0700				15		
			HCPL0730/0731				25		
			HCPL0700				1	10	
			HCPL0730/0731				2	20	
$T_{PLH}$	Propagation Delay Time to Logic High (Note 2) (Fig. 14)	$R_L = 4.7\ \text{k}\Omega$ , $I_F = 0.5\text{mA}$ $T_A = 25^\circ\text{C}$	HCPL0701/31			90	$\mu\text{s}$		
			HCPL0701/31			12		60	
		$R_L = 270\ \Omega$ , $I_F = 12\text{mA}$ $T_A = 25^\circ\text{C}$	HCPL0701				10		
			HCPL0731				15		
			HCPL0701				1.6	7	
			HCPL0731				1.6	10	
		$R_L = 2.2\ \text{k}\Omega$ , $I_F = 1.6\text{mA}$ $T_A = 25^\circ\text{C}$	HCPL0700/30/31				50		
			HCPL0700/30/31				7	35	
		$ICM_H$	Common Mode Transient Immunity at Logic High	$I_F = 0\text{mA}$ , $ V_{CM}  = 10\ \text{V}_{P-P}$ , $T_A = 25^\circ\text{C}$ , $R_L = 2.2\text{k}\Omega$ (Note 3) (Fig. 15)	ALL	1,000	10,000		$\text{V}/\mu\text{s}$
		$ICM_L$	Common Mode Transient Immunity at Logic Low	$I_F = 1.6\text{mA}$ , $ V_{CM}  = 10\ \text{V}_{P-P}$ , $T_A = 25^\circ\text{C}$ , $R_L = 2.2\ \text{k}\Omega$ (Note 3) (Fig. 15)	ALL	1,000	10,000		$\text{V}/\mu\text{s}$

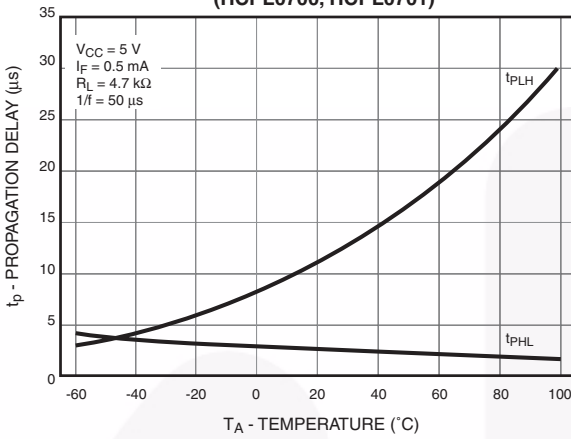
\*All typicals at  $T_A = 25^\circ\text{C}$

#### Notes:

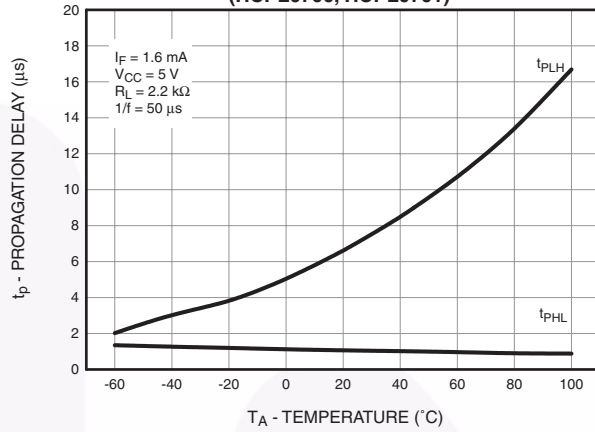
- Current Transfer Ratio is defined as a ratio of output collector current,  $I_O$ , to the forward LED input current,  $I_F$ , times 100%.
- Pin 7 open. Use of a resistor between pins 5 and 7 will decrease gain and delay time.
- Common mode transient immunity in logic high level is the maximum tolerable (positive)  $dV_{CM}/dt$  on the leading edge of the common mode pulse signal,  $V_{CM}$ , to assure that the output will remain in a logic high state (i.e.,  $V_O > 2.0\text{V}$ ). Common mode transient immunity in logic low level is the maximum tolerable (negative)  $dV_{CM}/dt$  on the trailing edge of the common mode pulse signal,  $V_{CM}$ , to assure that the output will remain in a logic low state (i.e.,  $V_O < 0.8\ \text{V}$ ).
- Device is considered a two terminal device: Pins 1, 2, 3 and 4 are shorted together and Pins 5, 6, 7 and 8 are shorted together.
- 2500 VAC RMS for 1 minute duration is equivalent to 3000 VAC RMS for 1 second duration.

## Typical Performance Curves

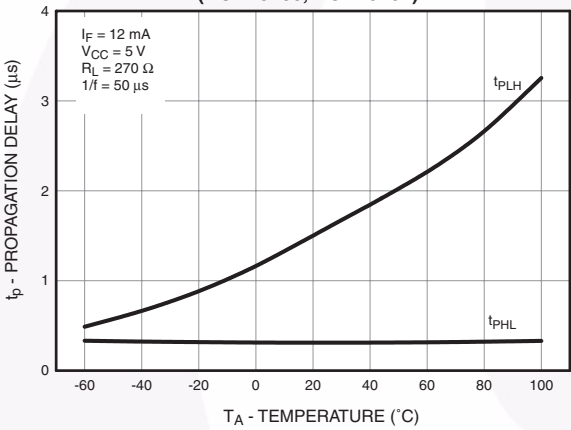
**Fig. 1 Propagation Delay vs. Temperature (HCPL0700, HCPL0701)**



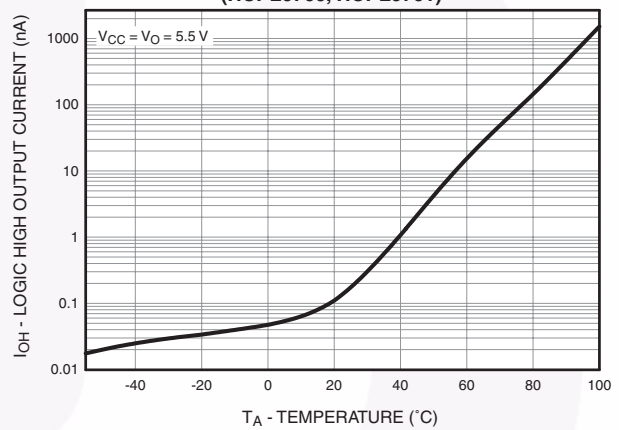
**Fig. 2 Propagation Delay vs. Temperature (HCPL0700, HCPL0701)**



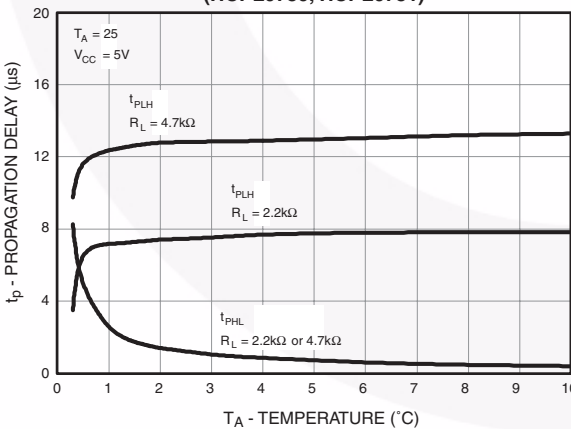
**Fig. 3 Propagation Delay vs. Temperature (HCPL0700, HCPL0701)**



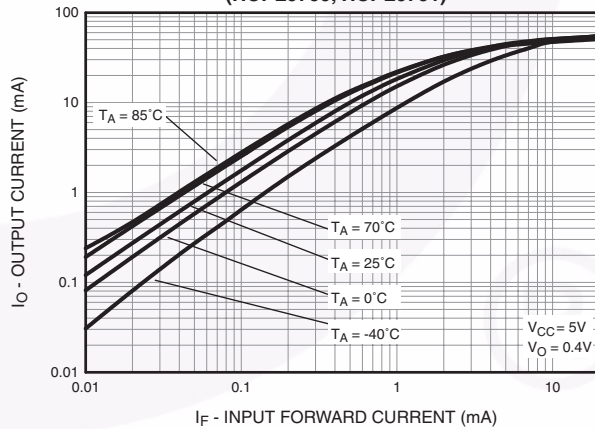
**Fig. 4 Logic High Output Current vs. Temperature (HCPL0700, HCPL0701)**



**Fig. 5 Propagation Delay vs. Input Forward Current (HCPL0730, HCPL0731)**

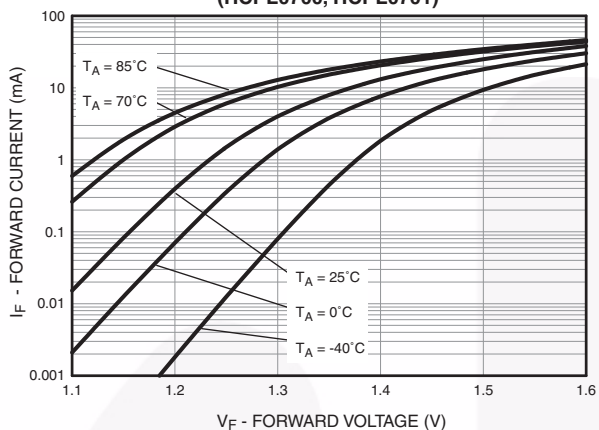


**Fig. 6 Output Current vs. Input Forward Current (HCPL0700, HCPL0701)**

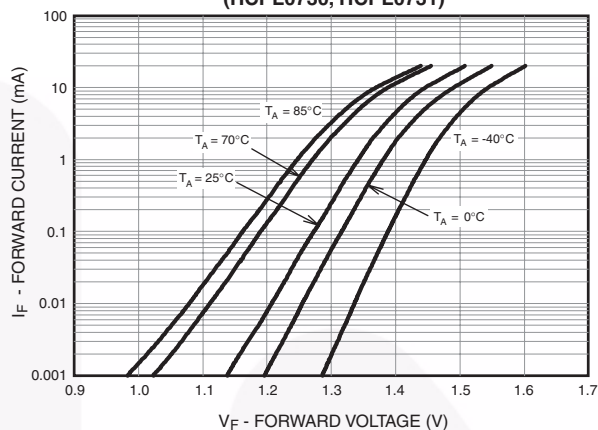


**Typical Performance Curves (Continued)**

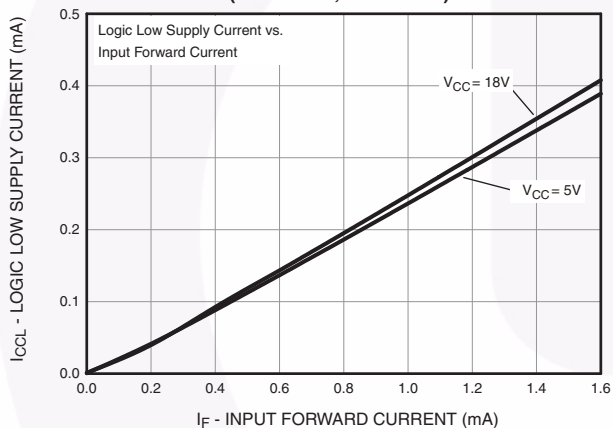
**Fig. 7 Input Forward Current vs. Forward Voltage (HCPL0700, HCPL0701)**



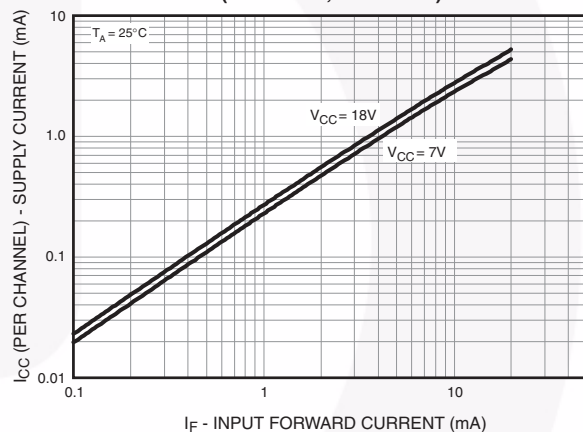
**Fig. 8 Input Forward Current vs. Forward Voltage (HCPL0730, HCPL0731)**



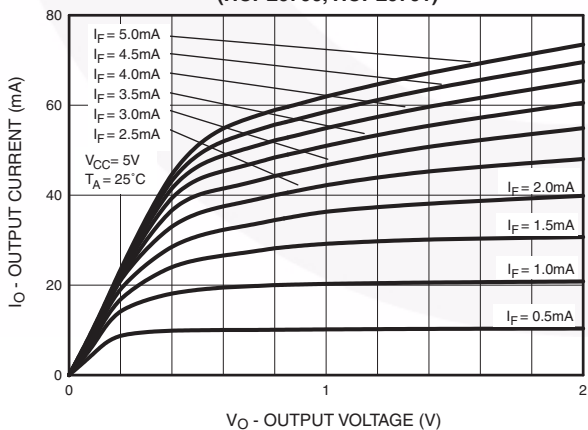
**Fig. 9 Logic Low Supply Current vs. Input Forward Current (HCPL0700, HCPL0701)**



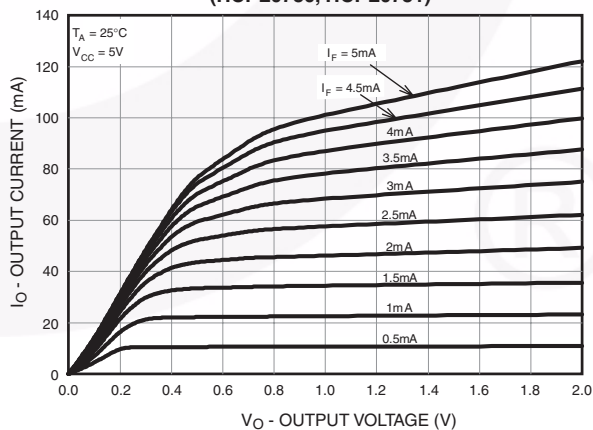
**Fig. 10 Supply Current vs. Input Forward Current (HCPL0730, HCPL0731)**



**Fig. 11 DC Transfer Characteristics (HCPL0700, HCPL0701)**

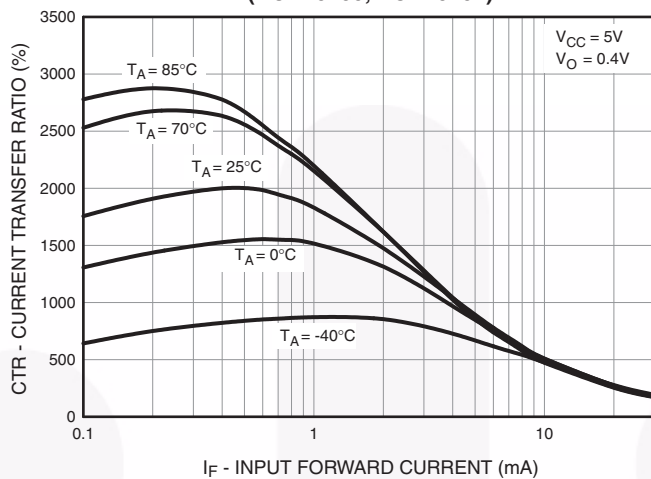


**Fig. 12 DC Transfer Characteristics (HCPL0730, HCPL0731)**



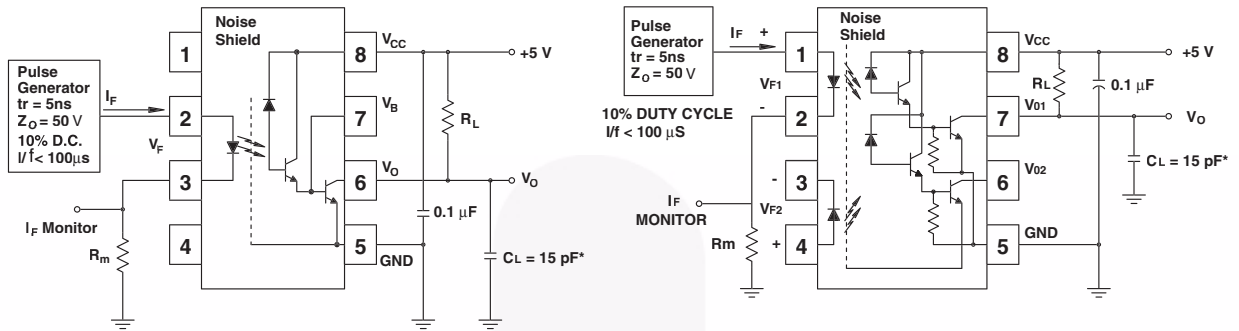
Typical Performance Curves (Continued)

Fig. 13 Current Transfer Ratio vs. Input Forward Current (HCPL0700, HCPL0701)





Test Circuits



Test Circuit for HCPL-0700 and HCPL-0701

Test Circuit for HCPL-0730 and HCPL-0731

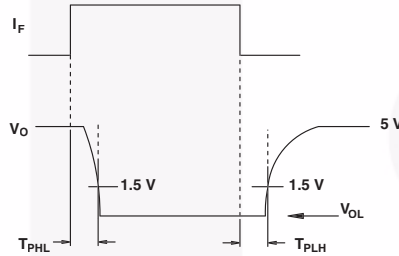
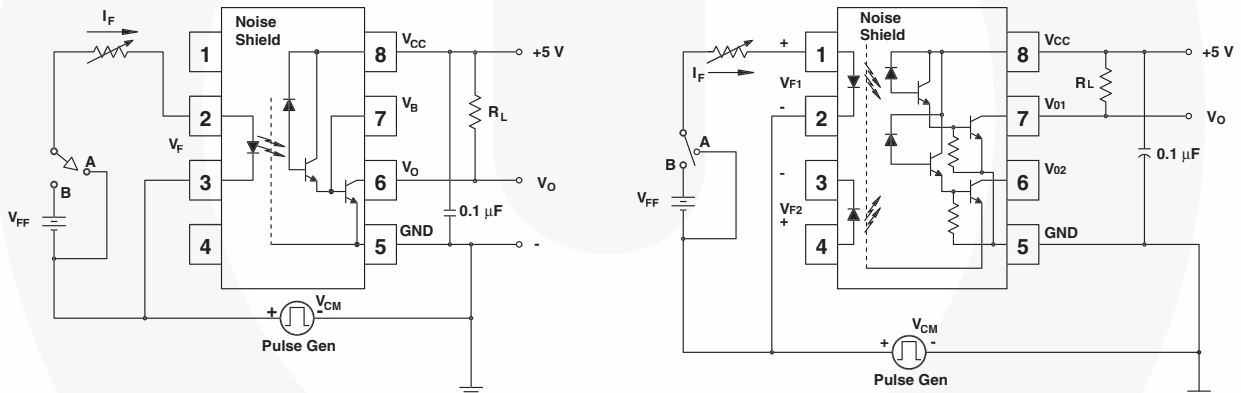


Fig. 14 Switching Time Test Circuit



Test Circuit for HCPL-0700 and HCPL-0701

Test Circuit for HCPL-0730 and HCPL-0731

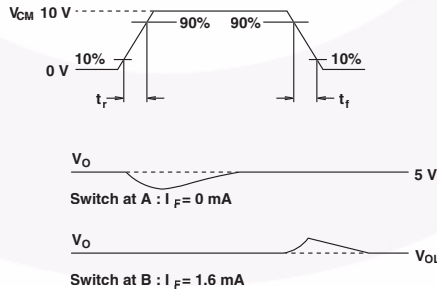


Fig. 15 Common Mode Immunity Test Circuit

### Ordering Information

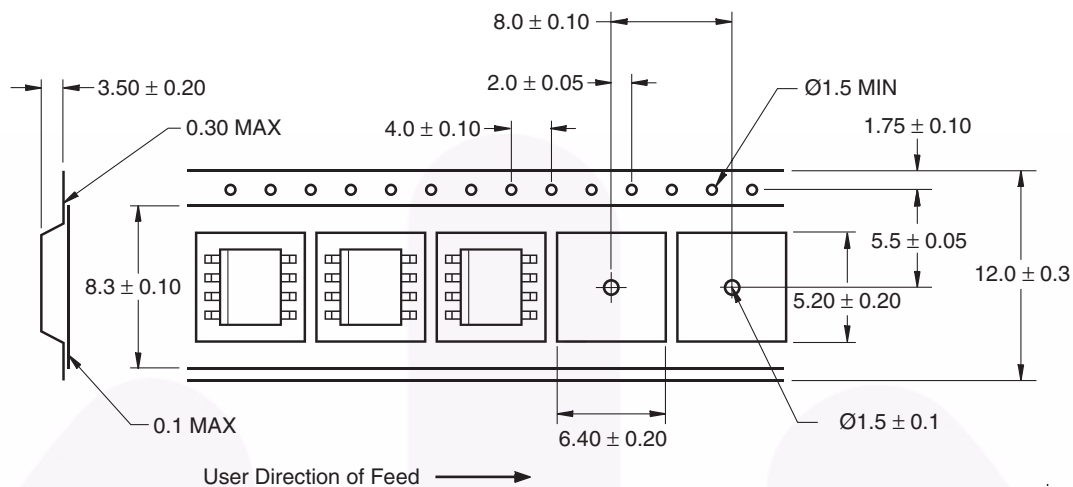
Option	Part Number Example	Description
V	HCPL0700V	VDE 0884
R2	HCPL0700R2	Tape and reel (2500 units per reel)
R2V	HCPL0700R2V	VDE 0884, Tape and reel (2500 units per reel)

### Marking Information



Definitions	
1	Fairchild logo
2	Device number
3	VDE mark (Note: Only appears on parts ordered with VDE option – See order entry table)
4	One digit year code, e.g., '3'
5	Two digit work week ranging from '01' to '53'
6	Assembly package code

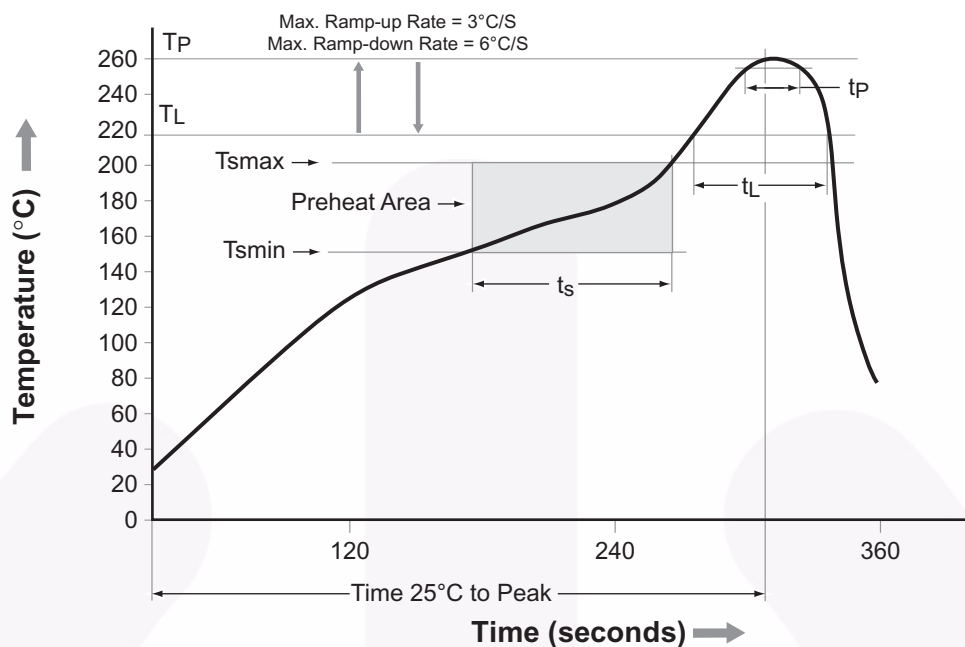
### Carrier Tape Specification



Dimensions in mm



## Reflow Profile



Profile Feature	Pb-Free Assembly Profile
Temperature Min. (T <sub>smín</sub> )	150°C
Temperature Max. (T <sub>smáx</sub> )	200°C
Time (t <sub>s</sub> ) from (T <sub>smín</sub> to T <sub>smáx</sub> )	60–120 seconds
Ramp-up Rate (t <sub>L</sub> to t <sub>p</sub> )	3°C/second max.
Liquidous Temperature (T <sub>L</sub> )	217°C
Time (t <sub>L</sub> ) Maintained Above (T <sub>L</sub> )	60–150 seconds
Peak Body Package Temperature	260°C +0°C / -5°C
Time (t <sub>p</sub> ) within 5°C of 260°C	30 seconds
Ramp-down Rate (T <sub>p</sub> to T <sub>L</sub> )	6°C/second max.
Time 25°C to Peak Temperature	8 minutes max.



NOTES:

- A) NO STANDARD APPLIES TO THIS PACKAGE
- B) ALL DIMENSIONS ARE IN MILLIMETERS.
- C) DIMENSIONS DO NOT INCLUDE MOLD FLASH OR BURRS.
- D) LANDPATTERN STANDARD: SOIC127P600X175-8M.
- E) DRAWING FILENAME: MKT-M08Erev5



ON Semiconductor and  are trademarks of Semiconductor Components Industries, LLC dba ON Semiconductor or its subsidiaries in the United States and/or other countries. ON Semiconductor owns the rights to a number of patents, trademarks, copyrights, trade secrets, and other intellectual property. A listing of ON Semiconductor's product/patent coverage may be accessed at [www.onsemi.com/site/pdf/Patent-Marking.pdf](http://www.onsemi.com/site/pdf/Patent-Marking.pdf). ON Semiconductor reserves the right to make changes without further notice to any products herein. ON Semiconductor makes no warranty, representation or guarantee regarding the suitability of its products for any particular purpose, nor does ON Semiconductor assume any liability arising out of the application or use of any product or circuit, and specifically disclaims any and all liability, including without limitation special, consequential or incidental damages. Buyer is responsible for its products and applications using ON Semiconductor products, including compliance with all laws, regulations and safety requirements or standards, regardless of any support or applications information provided by ON Semiconductor. "Typical" parameters which may be provided in ON Semiconductor data sheets and/or specifications can and do vary in different applications and actual performance may vary over time. All operating parameters, including "Typicals" must be validated for each customer application by customer's technical experts. ON Semiconductor does not convey any license under its patent rights nor the rights of others. ON Semiconductor products are not designed, intended, or authorized for use as a critical component in life support systems or any FDA Class 3 medical devices or medical devices with a same or similar classification in a foreign jurisdiction or any devices intended for implantation in the human body. Should Buyer purchase or use ON Semiconductor products for any such unintended or unauthorized application, Buyer shall indemnify and hold ON Semiconductor and its officers, employees, subsidiaries, affiliates, and distributors harmless against all claims, costs, damages, and expenses, and reasonable attorney fees arising out of, directly or indirectly, any claim of personal injury or death associated with such unintended or unauthorized use, even if such claim alleges that ON Semiconductor was negligent regarding the design or manufacture of the part. ON Semiconductor is an Equal Opportunity/Affirmative Action Employer. This literature is subject to all applicable copyright laws and is not for resale in any manner.

## PUBLICATION ORDERING INFORMATION

### LITERATURE FULFILLMENT:

Literature Distribution Center for ON Semiconductor  
19521 E. 32nd Pkwy, Aurora, Colorado 80011 USA  
**Phone:** 303-675-2175 or 800-344-3860 Toll Free USA/Canada  
**Fax:** 303-675-2176 or 800-344-3867 Toll Free USA/Canada  
**Email:** [orderlit@onsemi.com](mailto:orderlit@onsemi.com)

**N. American Technical Support:** 800-282-9855 Toll Free  
USA/Canada  
**Europe, Middle East and Africa Technical Support:**  
Phone: 421 33 790 2910  
**Japan Customer Focus Center**  
Phone: 81-3-5817-1050

**ON Semiconductor Website:** [www.onsemi.com](http://www.onsemi.com)  
**Order Literature:** <http://www.onsemi.com/orderlit>  
For additional information, please contact your local  
Sales Representative

# Mouser Electronics

Authorized Distributor

Click to View Pricing, Inventory, Delivery & Lifecycle Information:

[ON Semiconductor:](#)

[HCPL0700](#) [HCPL0700R2](#) [HCPL0700V](#)



Компания «ЭлектроПласт» предлагает заключение долгосрочных отношений при поставках импортных электронных компонентов на взаимовыгодных условиях!

Наши преимущества:

- Оперативные поставки широкого спектра электронных компонентов отечественного и импортного производства напрямую от производителей и с крупнейших мировых складов;
- Поставка более 17-ти миллионов наименований электронных компонентов;
- Поставка сложных, дефицитных, либо снятых с производства позиций;
- Оперативные сроки поставки под заказ (от 5 рабочих дней);
- Экспресс доставка в любую точку России;
- Техническая поддержка проекта, помощь в подборе аналогов, поставка прототипов;
- Система менеджмента качества сертифицирована по Международному стандарту ISO 9001;
- Лицензия ФСБ на осуществление работ с использованием сведений, составляющих государственную тайну;
- Поставка специализированных компонентов (Xilinx, Altera, Analog Devices, Intersil, Interpoint, Microsemi, Aeroflex, Peregrine, Syfer, Eurofarad, Texas Instrument, Miteq, Cobham, E2V, MA-COM, Hittite, Mini-Circuits, General Dynamics и др.);

Помимо этого, одним из направлений компании «ЭлектроПласт» является направление «Источники питания». Мы предлагаем Вам помощь Конструкторского отдела:

- Подбор оптимального решения, техническое обоснование при выборе компонента;
- Подбор аналогов;
- Консультации по применению компонента;
- Поставка образцов и прототипов;
- Техническая поддержка проекта;
- Защита от снятия компонента с производства.



#### Как с нами связаться

**Телефон:** 8 (812) 309 58 32 (многоканальный)

**Факс:** 8 (812) 320-02-42

**Электронная почта:** [org@eplast1.ru](mailto:org@eplast1.ru)

**Адрес:** 198099, г. Санкт-Петербург, ул. Калинина, дом 2, корпус 4, литера А.