

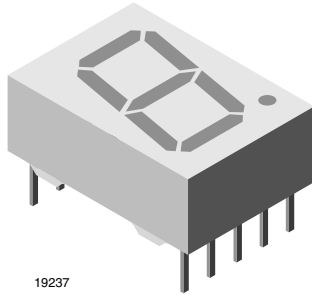

# Standard 7-Segment Display 13 mm



19237

## DESCRIPTION

The TDS.51.. series are 13 mm character seven segment LED displays in a very compact package.

The displays are designed for a viewing distance up to 7 m and available in four bright colors. The grey package surface and the evenly lighted untinted segments provide an optimum on-off contrast.

All displays are categorized in luminous intensity groups. That allows users to assemble displays with uniform appearance. Typical applications include instruments, panel meters, point-of-sale terminals and household equipment.

## FEATURES

- Evenly lighted segments
- Grey package surface
- Untinted segments
- Luminous intensity categorized
- Yellow and green categorized for color
- Wide viewing angle
- Suitable for DC and high peak current
- Compliant to RoHS directive 2002/95/EC and in accordance to WEEE 2002/96/EC



RoHS COMPLIANT

## APPLICATIONS

- Panel meters
- Test- and measure- equipment
- Point-of-sale terminals
- Control units
- TV sets

## PRODUCT GROUP AND PACKAGE DATA

- Product group: display
- Package: 13 mm
- Product series: standard
- Angle of half intensity: ± 50°

PARTS TABLE			
PART	COLOR	LUMINOUS INTENSITY AT 10 mA	CIRCUITRY
TDSO5150	Orange red	$I_V > 700 \mu\text{cd}$	Common anode
		$I_V = 5000 \mu\text{cd (typ.)}$	Common anode
TDSO5150-LM	Orange red	$I_V = (2800 \text{ to } 9000) \mu\text{cd}$	Common anode
TDSO5150-M	Orange red	$I_V = (4500 \text{ to } 9000) \mu\text{cd}$	Common anode
TDSO5160	Orange red	$I_V > 700 \mu\text{cd}$	Common cathode
		$I_V = 5000 \mu\text{cd (typ.)}$	Common cathode
TDSO5160-LM	Orange red	$I_V = (2800 \text{ to } 9000) \mu\text{cd}$	Common cathode
TDSY5150	Yellow	$I_V > 700 \mu\text{cd}$	Common anode
		$I_V = 4200 \mu\text{cd (typ.)}$	Common anode
TDSY5160	Yellow	$I_V > 700 \mu\text{cd}$	Common cathode
		$I_V = 4200 \mu\text{cd (typ.)}$	Common cathode
TDSG5150	Green	$I_V > 700 \mu\text{cd}$	Common anode
		$I_V = 9500 \mu\text{cd (typ.)}$	Common anode
TDSG5150-MN	Green	$I_V = (4500 \text{ to } 14\ 000) \mu\text{cd}$	Common anode
TDSG5150-N	Green	$I_V = (7000 \text{ to } 14\ 000) \mu\text{cd}$	Common anode
TDSG5160	Green	$I_V > 700 \mu\text{cd}$	Common cathode
		$I_V = 9500 \mu\text{cd (typ.)}$	Common cathode
TDSG5160-MN	Green	$I_V = (4500 \text{ to } 14\ 000) \mu\text{cd}$	Common cathode
TDSG5160-N	Green	$I_V = (7000 \text{ to } 14\ 000) \mu\text{cd}$	Common cathode

<b>ABSOLUTE MAXIMUM RATINGS</b> ( $T_{amb} = 25\text{ }^{\circ}\text{C}$ , unless otherwise specified) <b>TDSO5150, TDSO5160, TDSY5150, TDSY5160, TDSG5150, TDSG5160</b>					
PARAMETER	TEST CONDITION	SYMBOL	VALUE	UNIT	
Reverse voltage per segment or DP		$V_R$	6	V	
DC forward current per segment or DP	TDSO5150	$I_F$	25	mA	
	TDSO5160		25		
	TDSY5150		25		
	TDSY5160		25		
	TDSG5150		25		
	TDSG5160		25		
Surge forward current per segment or DP	$t_p \leq 10\text{ }\mu\text{s}$ (non repetitive)	$I_{FSM}$	0.15	A	
	TDSO5150		0.15		
	TDSO5160		0.15		
	TDSY5150		0.15		
	TDSY5160		0.15		
	TDSG5150		0.15		
Power dissipation	$T_{amb} \leq 45\text{ }^{\circ}\text{C}$	$P_V$	550	mW	
Junction temperature		$T_j$	100	$^{\circ}\text{C}$	
Operating temperature range		$T_{amb}$	- 40 to + 85	$^{\circ}\text{C}$	
Storage temperature range		$T_{stg}$	- 40 to + 85	$^{\circ}\text{C}$	
Soldering temperature	$t \leq 3\text{ s}$ , 2 mm below seating plane	$T_{sd}$	260	$^{\circ}\text{C}$	
Thermal resistance LED junction/ambient		$R_{thJA}$	100	K/W	

<b>OPTICAL AND ELECTRICAL CHARACTERISTICS</b> ( $T_{amb} = 25\text{ }^{\circ}\text{C}$ , unless otherwise specified) <b>TDSO5150, TDSO5160, ORANGE RED</b>							
PARAMETER	TEST CONDITION	PART	SYMBOL	MIN.	TYP.	MAX.	UNIT
Luminous intensity per segment (digit average) <sup>(1)</sup>	$I_F = 10\text{ mA}$	TDSO5150	$I_v$	700	5000	-	$\mu\text{cd}$
		TDSO5150-LM		2800	-	9000	
		TDSO5150-M		4500	-	9000	
		TDSO5160		700	5000	-	
		TDSO5160-LM		2800	-	9000	
Dominant wavelength	$I_F = 10\text{ mA}$	TDSO5150, TDSO5160	$\lambda_d$	612	-	625	nm
Peak wavelength	$I_F = 10\text{ mA}$		$\lambda_p$	-	630	-	nm
Angle of half intensity	$I_F = 10\text{ mA}$		$\varphi$	-	$\pm 50$	-	deg
Forward voltage per segment or DP	$I_F = 20\text{ mA}$		$V_F$	-	2	3	V
Reverse voltage per segment or DP	$I_R = 10\text{ }\mu\text{A}$		$V_R$	6	15	-	V

**Note**

<sup>(1)</sup>  $I_{vmin.}$  and  $I_v$  groups are mean values of all segments (a to g, D1 to D4), matching factor within segments is  $\geq 0.5$ , excluding decimal points and colon.



# TDSG5150, TDSG5160, TDSO5150, TDSO5160, TDSY5150, TDSY5160

Standard 7-Segment Display 13 mm Vishay Semiconductors

## OPTICAL AND ELECTRICAL CHARACTERISTICS ( $T_{amb} = 25\text{ }^{\circ}\text{C}$ , unless otherwise specified) TDSY5150, TDSY5160, YELLOW

PARAMETER	TEST CONDITION	PART	SYMBOL	MIN.	TYP.	MAX.	UNIT
Luminous intensity per segment (digit average) <sup>(1)</sup>	$I_F = 10\text{ mA}$	TDSY5150	$I_V$	700	4200	-	$\mu\text{cd}$
		TDSY5160		700	4200	-	
Dominant wavelength	$I_F = 10\text{ mA}$	TDSY5150, TDSY5160	$\lambda_d$	581	-	594	nm
Peak wavelength	$I_F = 10\text{ mA}$		$\lambda_p$	-	585	-	nm
Angle of half intensity	$I_F = 10\text{ mA}$		$\varphi$	-	$\pm 50$	-	deg
Forward voltage per segment or DP	$I_F = 20\text{ mA}$		$V_F$	-	2.4	3	V
Reverse voltage per segment or DP	$I_R = 10\text{ }\mu\text{A}$		$V_R$	6	15	-	V

### Note

<sup>(1)</sup>  $I_{Vmin}$  and  $I_V$  groups are mean values of all segments (a to g, D1 to D4), matching factor within segments is  $\leq 0.5$ , excluding decimal points and colon.

## OPTICAL AND ELECTRICAL CHARACTERISTICS ( $T_{amb} = 25\text{ }^{\circ}\text{C}$ , unless otherwise specified) TDSG5150, TDSG5160, GREEN

PARAMETER	TEST CONDITION	PART	SYMBOL	MIN.	TYP.	MAX.	UNIT
Luminous intensity per segment (digit average) <sup>(1)</sup>	$I_F = 10\text{ mA}$	TDSG5150	$I_V$	700	9500	-	$\mu\text{cd}$
		TDSG5150-MN		4500	-	14 000	
		TDSG5150-N		7000	-	14 000	
		TDSG5160		700	9500	-	
		TDSG5160-MN		4500	-	14 000	
		TDSG5160-N		7000	-	14 000	
Dominant wavelength	$I_F = 10\text{ mA}$	TDSG5150, TDSG5160	$\lambda_d$	562	-	575	nm
Peak wavelength	$I_F = 10\text{ mA}$		$\lambda_p$	-	565	-	nm
Angle of half intensity	$I_F = 10\text{ mA}$		$\varphi$	-	$\pm 50$	-	deg
Forward voltage per segment or DP	$I_F = 20\text{ mA}$		$V_F$	-	2.4	3	V
Reverse voltage per segment or DP	$I_R = 10\text{ }\mu\text{A}$		$V_R$	6	15	-	V

### Note

<sup>(1)</sup>  $I_{Vmin}$  and  $I_V$  groups are mean values of all segments (a to g, D1 to D4), matching factor within segments is  $\geq 0.5$ , excluding decimal points and colon.

## LUMINOUS INTENSITY CLASSIFICATION

GROUP	LIGHT INTENSITY ( $\mu\text{cd}$ )	
	MIN.	MAX.
E	180	360
F	280	560
G	450	900
H	700	1400
I	1100	2200
K	1800	3600
L	2800	5600
M	4500	9000
N	7000	14 000

### Note

The above type numbers represent the order groups which include only a few brightness groups. Only one group will be shipped in one tube (there will be no mixing of two groups in one tube). In order to ensure availability, single brightness groups will not be orderable.

## COLOR CLASSIFICATION

GROUP	ORANGE RED		YELLOW		GREEN	
	MIN.	MAX.	MIN.	MAX.	MIN.	MAX.
1	598	601	581	584		
2	600	603	583	586	562	565
3	602	605	585	588	564	567
4	604	607	587	590	566	569
5	606	609	589	592	568	571
6	608	611	591	594	570	573
7					570	575

### Note

Wavelengths are tested at a current pulse duration of 25 ms and an accuracy of  $\pm 1\text{ nm}$ .

**TYPICAL CHARACTERISTICS** ( $T_{amb} = 25\text{ }^{\circ}\text{C}$ , unless otherwise specified)

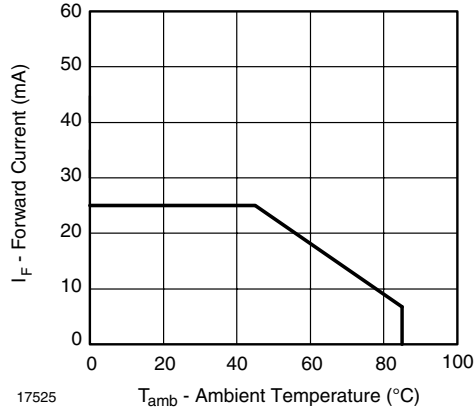

Fig. 1 - Forward Current vs. Ambient Temperature

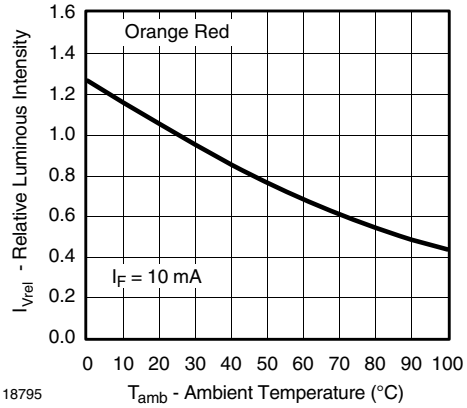

Fig. 4 - Rel. Luminous Intensity vs. Ambient Temperature

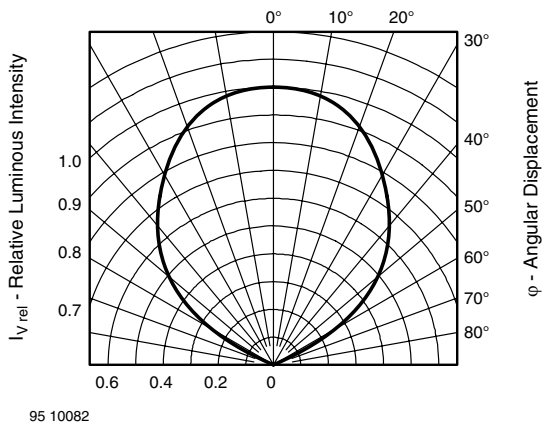

Fig. 2 - Rel. Luminous Intensity vs. Angular Displacement

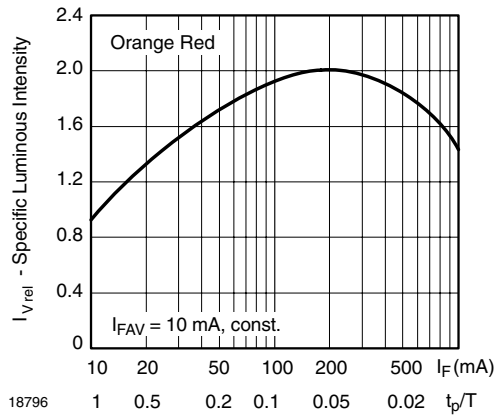

Fig. 5 - Rel. Lumin. Intensity vs. Forw. Current/Duty Cycle

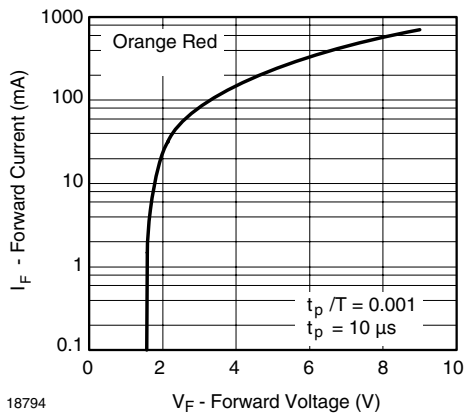

Fig. 3 - Forward Current vs. Forward Voltage

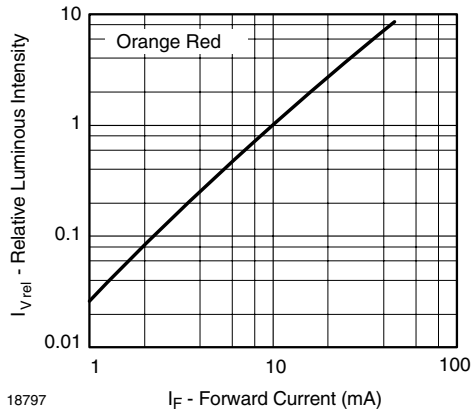

Fig. 6 - Relative Luminous Intensity vs. Forward Current

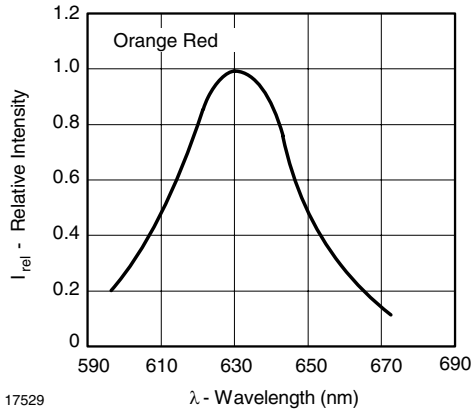

Fig. 7 - Relative Intensity vs. Wavelength

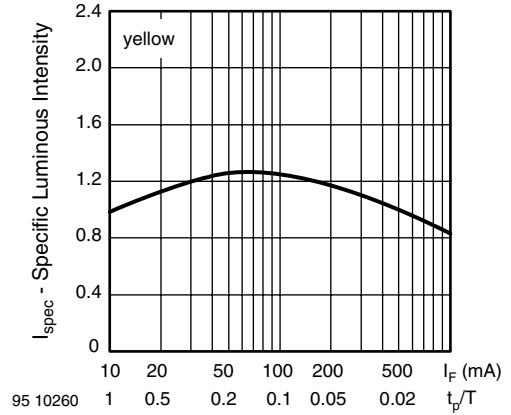

Fig. 10 - Rel. Lumin. Intensity vs. Forw. Current/Duty Cycle

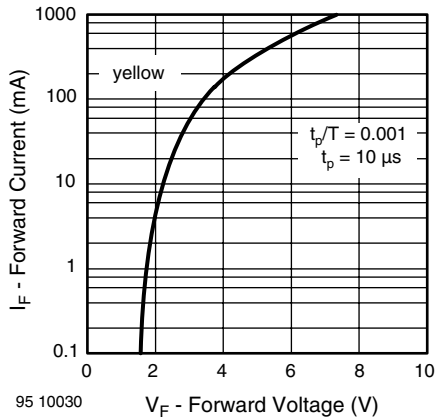

Fig. 8 - Forward Current vs. Forward Voltage

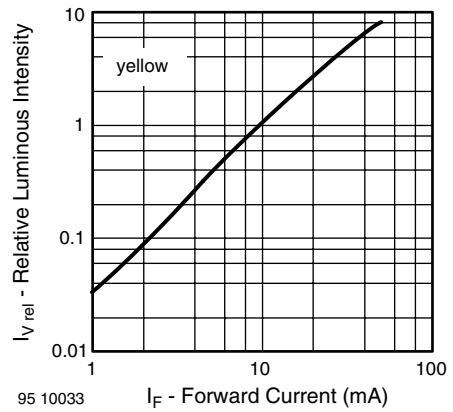

Fig. 11 - Relative Luminous Intensity vs. Forward Current

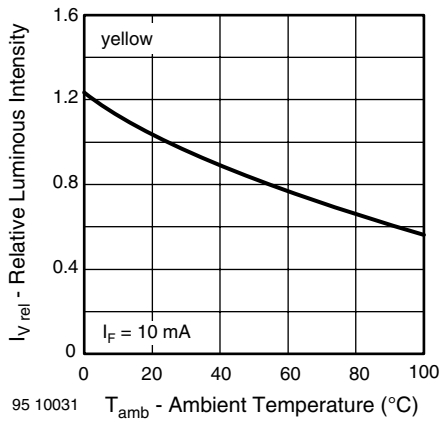

Fig. 9 - Rel. Luminous Intensity vs. Ambient Temperature

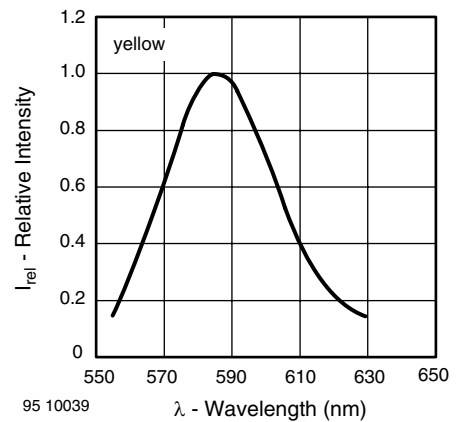

Fig. 12 - Relative Intensity vs. Wavelength

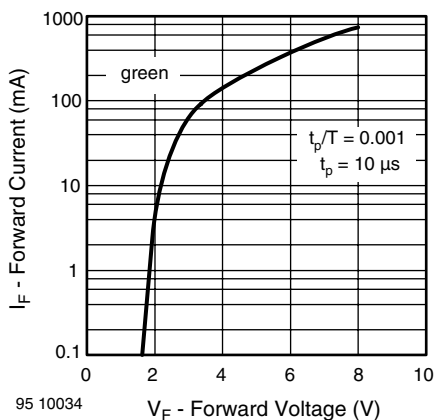

Fig. 13 - Forward Current vs. Forward Voltage

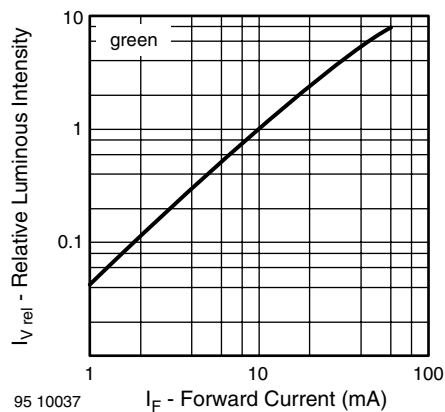

Fig. 16 - Relative Luminous Intensity vs. Forward Current

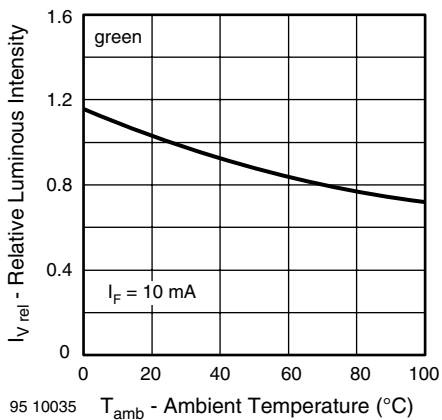

Fig. 14 - Rel. Luminous Intensity vs. Ambient Temperature

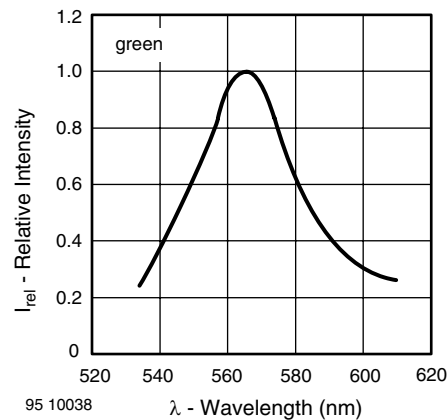

Fig. 17 - Relative Intensity vs. Wavelength

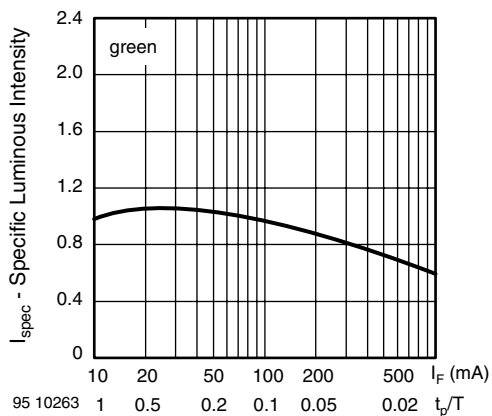

Fig. 15 - Specific Luminous Intensity vs. Forward Current

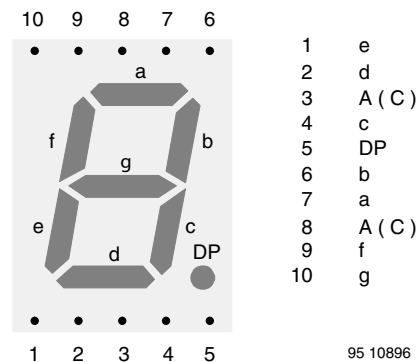

Fig. 18 - TDS.51..



# TDSG5150, TDSG5160, TDSO5150, TDSO5160, TDSY5150, TDSY5160

Standard 7-Segment Display 13 mm Vishay Semiconductors

## PACKAGE DIMENSIONS FOR TDS.51.. in millimeters

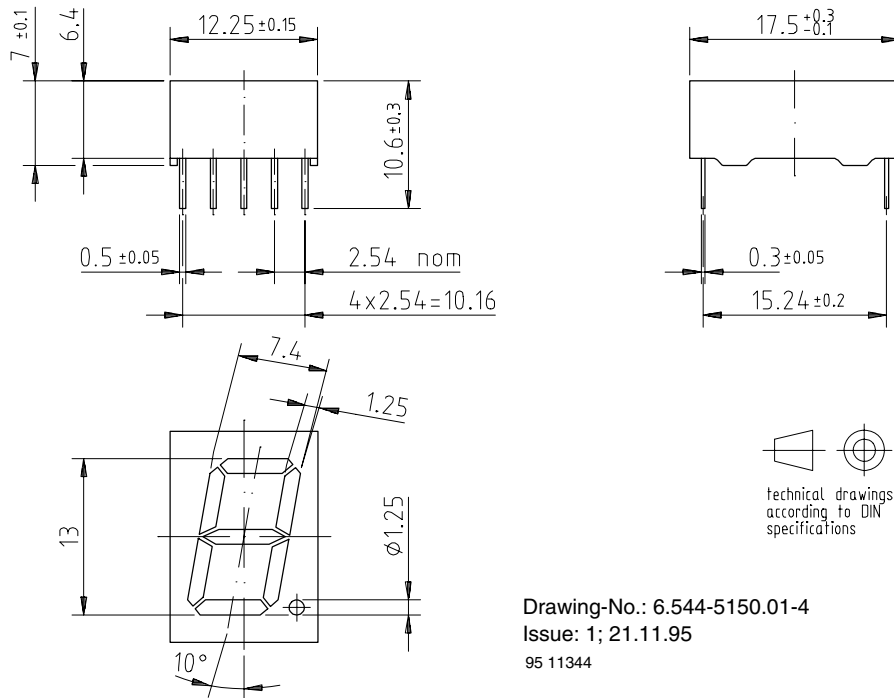

Drawing-No.: 6.544-5150.01-4  
Issue: 1; 21.11.95  
95 11344

# Display-13 mm

## Package Dimensions in mm

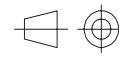
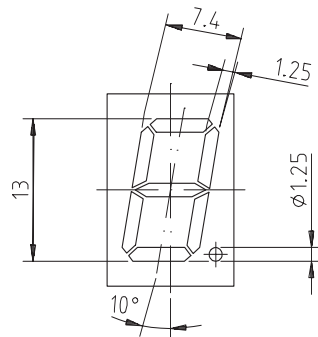
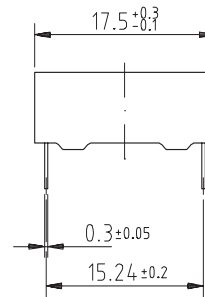
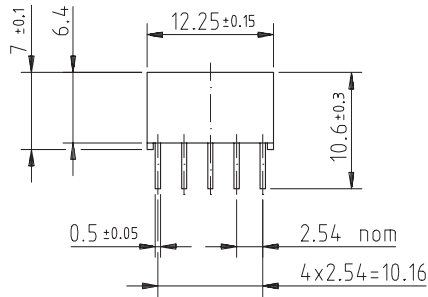

technical drawings  
according to DIN  
specifications

95 11344



## Ozone Depleting Substances Policy Statement

It is the policy of **Vishay Semiconductor GmbH** to

1. Meet all present and future national and international statutory requirements.
2. Regularly and continuously improve the performance of our products, processes, distribution and operating systems with respect to their impact on the health and safety of our employees and the public, as well as their impact on the environment.

It is particular concern to control or eliminate releases of those substances into the atmosphere which are known as ozone depleting substances (ODSs).

The Montreal Protocol (1987) and its London Amendments (1990) intend to severely restrict the use of ODSs and forbid their use within the next ten years. Various national and international initiatives are pressing for an earlier ban on these substances.

**Vishay Semiconductor GmbH** has been able to use its policy of continuous improvements to eliminate the use of ODSs listed in the following documents.

1. Annex A, B and list of transitional substances of the Montreal Protocol and the London Amendments respectively
2. Class I and II ozone depleting substances in the Clean Air Act Amendments of 1990 by the Environmental Protection Agency (EPA) in the USA
3. Council Decision 88/540/EEC and 91/690/EEC Annex A, B and C (transitional substances) respectively.

**Vishay Semiconductor GmbH** can certify that our semiconductors are not manufactured with ozone depleting substances and do not contain such substances.

**We reserve the right to make changes to improve technical design  
and may do so without further notice.**

Parameters can vary in different applications. All operating parameters must be validated for each customer application by the customer. Should the buyer use Vishay Semiconductors products for any unintended or unauthorized application, the buyer shall indemnify Vishay Semiconductors against all claims, costs, damages, and expenses, arising out of, directly or indirectly, any claim of personal damage, injury or death associated with such unintended or unauthorized use.

Vishay Semiconductor GmbH, P.O.B. 3535, D-74025 Heilbronn, Germany  
Telephone: 49 (0)7131 67 2831, Fax number: 49 (0)7131 67 2423

# Pin Connections 13 mm

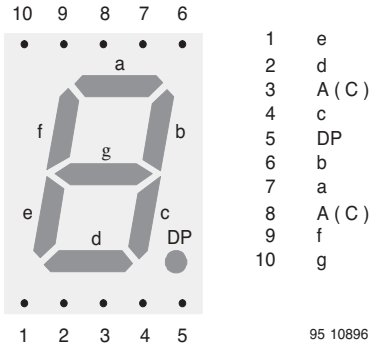

## Ozone Depleting Substances Policy Statement

It is the policy of **Vishay Semiconductor GmbH** to

1. Meet all present and future national and international statutory requirements.
2. Regularly and continuously improve the performance of our products, processes, distribution and operating systems with respect to their impact on the health and safety of our employees and the public, as well as their impact on the environment.

It is particular concern to control or eliminate releases of those substances into the atmosphere which are known as ozone depleting substances (ODSs).

The Montreal Protocol (1987) and its London Amendments (1990) intend to severely restrict the use of ODSs and forbid their use within the next ten years. Various national and international initiatives are pressing for an earlier ban on these substances.

**Vishay Semiconductor GmbH** has been able to use its policy of continuous improvements to eliminate the use of ODSs listed in the following documents.

1. Annex A, B and list of transitional substances of the Montreal Protocol and the London Amendments respectively
2. Class I and II ozone depleting substances in the Clean Air Act Amendments of 1990 by the Environmental Protection Agency (EPA) in the USA
3. Council Decision 88/540/EEC and 91/690/EEC Annex A, B and C (transitional substances) respectively.

**Vishay Semiconductor GmbH** can certify that our semiconductors are not manufactured with ozone depleting substances and do not contain such substances.

**We reserve the right to make changes to improve technical design  
and may do so without further notice.**

Parameters can vary in different applications. All operating parameters must be validated for each customer application by the customer. Should the buyer use Vishay Semiconductors products for any unintended or unauthorized application, the buyer shall indemnify Vishay Semiconductors against all claims, costs, damages, and expenses, arising out of, directly or indirectly, any claim of personal damage, injury or death associated with such unintended or unauthorized use.

Vishay Semiconductor GmbH, P.O.B. 3535, D-74025 Heilbronn, Germany  
Telephone: 49 (0)7131 67 2831, Fax number: 49 (0)7131 67 2423



## Disclaimer

ALL PRODUCT, PRODUCT SPECIFICATIONS AND DATA ARE SUBJECT TO CHANGE WITHOUT NOTICE TO IMPROVE RELIABILITY, FUNCTION OR DESIGN OR OTHERWISE.

Vishay Intertechnology, Inc., its affiliates, agents, and employees, and all persons acting on its or their behalf (collectively, "Vishay"), disclaim any and all liability for any errors, inaccuracies or incompleteness contained in any datasheet or in any other disclosure relating to any product.

Vishay makes no warranty, representation or guarantee regarding the suitability of the products for any particular purpose or the continuing production of any product. To the maximum extent permitted by applicable law, Vishay disclaims (i) any and all liability arising out of the application or use of any product, (ii) any and all liability, including without limitation special, consequential or incidental damages, and (iii) any and all implied warranties, including warranties of fitness for particular purpose, non-infringement and merchantability.

Statements regarding the suitability of products for certain types of applications are based on Vishay's knowledge of typical requirements that are often placed on Vishay products in generic applications. Such statements are not binding statements about the suitability of products for a particular application. It is the customer's responsibility to validate that a particular product with the properties described in the product specification is suitable for use in a particular application. Parameters provided in datasheets and/or specifications may vary in different applications and performance may vary over time. All operating parameters, including typical parameters, must be validated for each customer application by the customer's technical experts. Product specifications do not expand or otherwise modify Vishay's terms and conditions of purchase, including but not limited to the warranty expressed therein.

Except as expressly indicated in writing, Vishay products are not designed for use in medical, life-saving, or life-sustaining applications or for any other application in which the failure of the Vishay product could result in personal injury or death. Customers using or selling Vishay products not expressly indicated for use in such applications do so at their own risk and agree to fully indemnify and hold Vishay and its distributors harmless from and against any and all claims, liabilities, expenses and damages arising or resulting in connection with such use or sale, including attorneys fees, even if such claim alleges that Vishay or its distributor was negligent regarding the design or manufacture of the part. Please contact authorized Vishay personnel to obtain written terms and conditions regarding products designed for such applications.

No license, express or implied, by estoppel or otherwise, to any intellectual property rights is granted by this document or by any conduct of Vishay. Product names and markings noted herein may be trademarks of their respective owners.



Компания «ЭлектроПласт» предлагает заключение долгосрочных отношений при поставках импортных электронных компонентов на взаимовыгодных условиях!

Наши преимущества:

- Оперативные поставки широкого спектра электронных компонентов отечественного и импортного производства напрямую от производителей и с крупнейших мировых складов;
- Поставка более 17-ти миллионов наименований электронных компонентов;
- Поставка сложных, дефицитных, либо снятых с производства позиций;
- Оперативные сроки поставки под заказ (от 5 рабочих дней);
- Экспресс доставка в любую точку России;
- Техническая поддержка проекта, помощь в подборе аналогов, поставка прототипов;
- Система менеджмента качества сертифицирована по Международному стандарту ISO 9001;
- Лицензия ФСБ на осуществление работ с использованием сведений, составляющих государственную тайну;
- Поставка специализированных компонентов (Xilinx, Altera, Analog Devices, Intersil, Interpoint, Microsemi, Aeroflex, Peregrine, Syfer, Eurofarad, Texas Instrument, Miteq, Cobham, E2V, MA-COM, Hittite, Mini-Circuits, General Dynamics и др.);

Помимо этого, одним из направлений компании «ЭлектроПласт» является направление «Источники питания». Мы предлагаем Вам помощь Конструкторского отдела:

- Подбор оптимального решения, техническое обоснование при выборе компонента;
- Подбор аналогов;
- Консультации по применению компонента;
- Поставка образцов и прототипов;
- Техническая поддержка проекта;
- Защита от снятия компонента с производства.



#### Как с нами связаться

**Телефон:** 8 (812) 309 58 32 (многоканальный)

**Факс:** 8 (812) 320-02-42

**Электронная почта:** [org@eplast1.ru](mailto:org@eplast1.ru)

**Адрес:** 198099, г. Санкт-Петербург, ул. Калинина, дом 2, корпус 4, литера А.