

LW P473 binning FK0PN0

PointLED®

With a diameter of just 2 mm, the PointLED is one of the smallest packages in its class and achieves high luminous efficacies.

Due to its round and flat package, measuring only 0.775 mm high, it is ideal for application where space is a sensitive issue.



Applications

- Cluster, Button Backlighting
- Electronic Equipment
- Gaming, Amusement, Gambling
- Interior Illumination (e.g. Ambient Map)
- Transportation, Plane, Ship
- White Goods

Features:

- Package: white SMT package, colored diffused resin
- Chip technology: InGaN
- Typ. Radiation: 120° (Lambertian emitter)
- Color: Cx = 0.33, Cy = 0.33 acc. to CIE 1931 (● white)
- Corrosion Robustness Class: 3B
- ESD: 2 kV acc. to ANSI/ESDA/JEDEC JS-001 (HBM, Class 2)

Ordering Information

Type	Luminous Intensity ¹⁾ $I_F = 10 \text{ mA}$ I_v	Mounting methode	Ordering Code
LW P473-Q2S1-FK0PN0-3B5A-F	90 ... 224 mcd	Top	Q65112A1442
LW P473-Q2S1-FK0PN0-3B5A	90 ... 224 mcd	Reverse	Q65112A1443

Maximum Ratings

Parameter	Symbol		Values
Operating Temperature	T_{op}	min.	-40 °C
		max.	100 °C
Storage Temperature	T_{stg}	min.	-40 °C
		max.	100 °C
Junction Temperature	T_j	max.	110 °C
Forward Current $T_s = 25\text{ °C}$	I_F	max.	20 mA
Surge Current $t \leq 10\ \mu\text{s}$; $D = 0.005$; $T_s = 25\text{ °C}$	I_{FS}	max.	200 mA
Reverse voltage ²⁾ $T_s = 25\text{ °C}$	V_R	max.	5 V
ESD withstand voltage acc. to ANSI/ESDA/JEDEC JS-001 (HBM, Class 2)	V_{ESD}		2 kV

Characteristics

$I_F = 10 \text{ mA}$; $T_s = 25 \text{ °C}$

Parameter	Symbol		Values
Chromaticity Coordinate ³⁾	C_x	typ.	0.33
	C_y	typ.	0.33
Viewing angle at 50 % I_v	2ϕ	typ.	120 °
Forward Voltage ⁴⁾ $I_F = 10 \text{ mA}$	V_F	min.	2.70 V
		typ.	3.10 V
		max.	3.40 V
Reverse current ²⁾ $V_R = 5 \text{ V}$	I_R	typ.	0.01 μA
		max.	10 μA
Real thermal resistance junction/ambient ^{5), 6)}	$R_{thJA \text{ real}}$	max.	480 K / W
Real thermal resistance junction/solderpoint ⁵⁾	$R_{thJS \text{ real}}$	max.	230 K / W

Brightness Groups

Group	Luminous Intensity ¹⁾ $I_F = 10 \text{ mA}$ min. I_v	Luminous Intensity ¹⁾ $I_F = 10 \text{ mA}$ max. I_v	Luminous Flux ⁷⁾ $I_F = 10 \text{ mA}$ typ. Φ_v
Q2	90 mcd	112 mcd	303 mlm
R1	112 mcd	140 mcd	378 mlm
R2	140 mcd	180 mcd	480 mlm
S1	180 mcd	224 mcd	606 mlm

Forward Voltage Groups

Group	Forward Voltage ⁴⁾ $I_F = 10 \text{ mA}$ min. V_F	Forward Voltage ⁴⁾ $I_F = 10 \text{ mA}$ max. V_F
3B	2.70 V	2.90 V
4A	2.90 V	3.05 V
4B	3.05 V	3.20 V
5A	3.20 V	3.40 V

Chromaticity Coordinate Groups

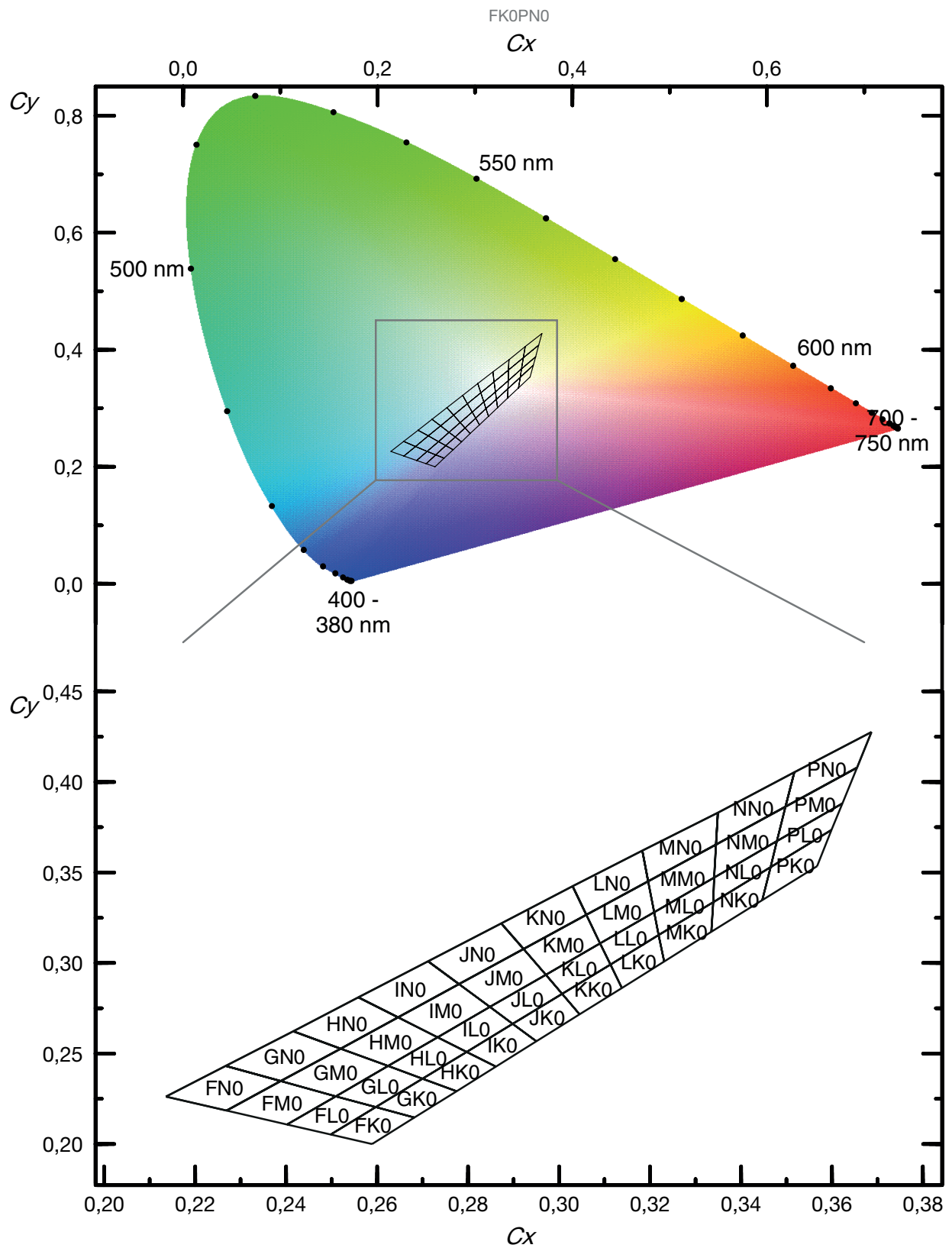

Color Chromaticity Groups ³⁾

Group	Cx	Cy	Group	Cx	Cy	Group	Cx	Cy
FK0	0.2498	0.2053	HK0	0.2700	0.2361	JK0	0.2898	0.2664
	0.2597	0.2204		0.2797	0.2509		0.3007	0.2830
	0.2682	0.2146		0.2861	0.2427		0.3045	0.2717
	0.2589	0.2000		0.2775	0.2292		0.2950	0.2568
FL0	0.2402	0.2108	HLO	0.2624	0.2431	JL0	0.2848	0.2757
	0.2509	0.2264		0.2733	0.2590		0.2971	0.2935
	0.2597	0.2204		0.2797	0.2509		0.3007	0.2830
	0.2498	0.2053		0.2700	0.2361		0.2898	0.2664
FM0	0.2269	0.2185	HMO	0.2520	0.2527	JMO	0.2780	0.2883
	0.2388	0.2348		0.2646	0.2700		0.2922	0.3077
	0.2509	0.2264		0.2733	0.2590		0.2971	0.2935
	0.2402	0.2108		0.2624	0.2431		0.2848	0.2757
FN0	0.2136	0.2262	HNO	0.2416	0.2623	JNO	0.2712	0.3009
	0.2267	0.2432		0.2559	0.2810		0.2873	0.3219
	0.2388	0.2348		0.2646	0.2700		0.2922	0.3077
	0.2269	0.2185		0.2520	0.2527		0.2780	0.2883
GK0	0.2597	0.2204	IK0	0.2797	0.2509	KK0	0.3007	0.2830
	0.2700	0.2361		0.2898	0.2664		0.3113	0.2992
	0.2775	0.2292		0.2950	0.2568		0.3138	0.2862
	0.2682	0.2146		0.2861	0.2427		0.3045	0.2717
GL0	0.2509	0.2264	ILO	0.2733	0.2590	KLO	0.2971	0.2935
	0.2624	0.2431		0.2848	0.2757		0.3090	0.3108
	0.2700	0.2361		0.2898	0.2664		0.3113	0.2992
	0.2597	0.2204		0.2797	0.2509		0.3007	0.2830
GM0	0.2388	0.2348	IMO	0.2646	0.2700	KM0	0.2922	0.3077
	0.2520	0.2527		0.2780	0.2883		0.3060	0.3266
	0.2624	0.2431		0.2848	0.2757		0.3090	0.3108
	0.2509	0.2264		0.2733	0.2590		0.2971	0.2935
GN0	0.2267	0.2432	INO	0.2559	0.2810	KN0	0.2873	0.3219
	0.2416	0.2623		0.2712	0.3009		0.3030	0.3424
	0.2520	0.2527		0.2780	0.2883		0.3060	0.3266
	0.2388	0.2348		0.2646	0.2700		0.2922	0.3077

Group	Cx	Cy	Group	Cx	Cy	Group	Cx	Cy
LK0	0.3113	0.2992	MM0	0.3196	0.3451	PK0	0.3465	0.3530
	0.3219	0.3154		0.3345	0.3654		0.3599	0.3735
	0.3231	0.3008		0.3341	0.3472		0.3567	0.3535
	0.3138	0.2862		0.3209	0.3281		0.3447	0.3347
LLO	0.3090	0.3108	MNO	0.3183	0.3621	PLO	0.3479	0.3673
	0.3209	0.3281		0.3349	0.3830		0.3623	0.3882
	0.3219	0.3154		0.3345	0.3654		0.3599	0.3735
	0.3113	0.2992		0.3196	0.3451		0.3465	0.3530
LMO	0.3060	0.3266	NKO	0.3339	0.3336	PM0	0.3498	0.3863
	0.3196	0.3451		0.3465	0.3530		0.3655	0.4079
	0.3209	0.3281		0.3447	0.3347		0.3623	0.3882
	0.3090	0.3108		0.3335	0.3172		0.3479	0.3673
LNO	0.3030	0.3424	NLO	0.3341	0.3472	PNO	0.3517	0.4053
	0.3183	0.3621		0.3479	0.3673		0.3687	0.4276
	0.3196	0.3451		0.3465	0.3530		0.3655	0.4079
	0.3060	0.3266		0.3339	0.3336		0.3498	0.3863
MK0	0.3219	0.3154	NMO	0.3345	0.3654			
	0.3339	0.3336		0.3498	0.3863			
	0.3335	0.3172		0.3479	0.3673			
	0.3231	0.3008		0.3341	0.3472			
MLO	0.3209	0.3281	NNO	0.3349	0.3830			
	0.3341	0.3472		0.3517	0.4053			
	0.3339	0.3336		0.3498	0.3863			
	0.3219	0.3154		0.3345	0.3654			

Group Name on Label

Example: Q2-FK0-3B

Brightness

Color Chromaticity

Forward Voltage

Q2

FK0

3B

Relative Spectral Emission ⁷⁾

$I_{rel} = f(\lambda); I_F = 10 \text{ mA}; T_S = 25 \text{ }^\circ\text{C}$

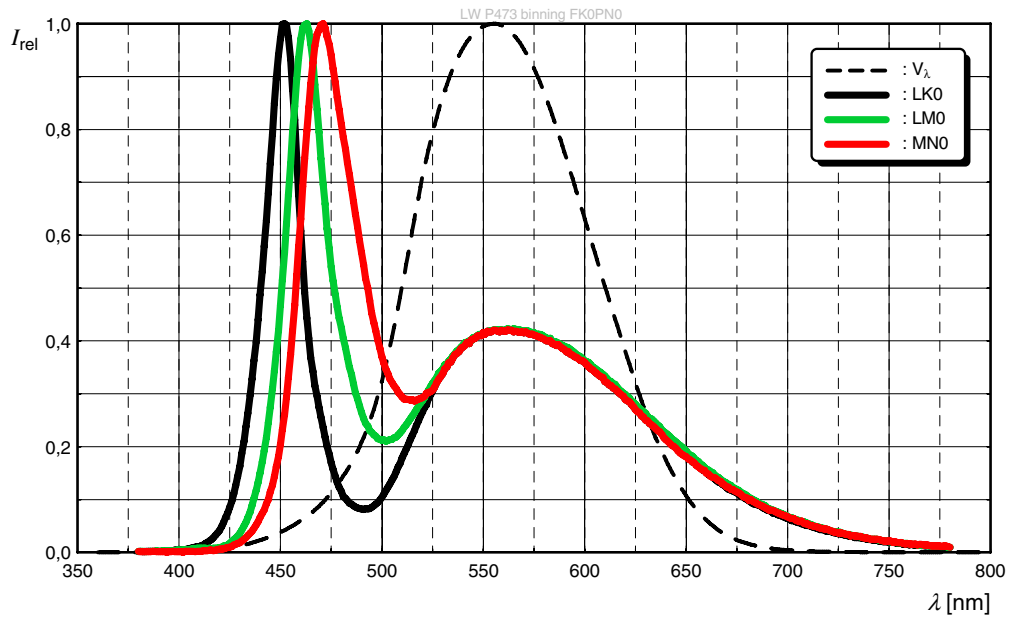

Radiation Characteristics ⁷⁾

$I_{rel} = f(\phi); T_S = 25 \text{ }^\circ\text{C}$

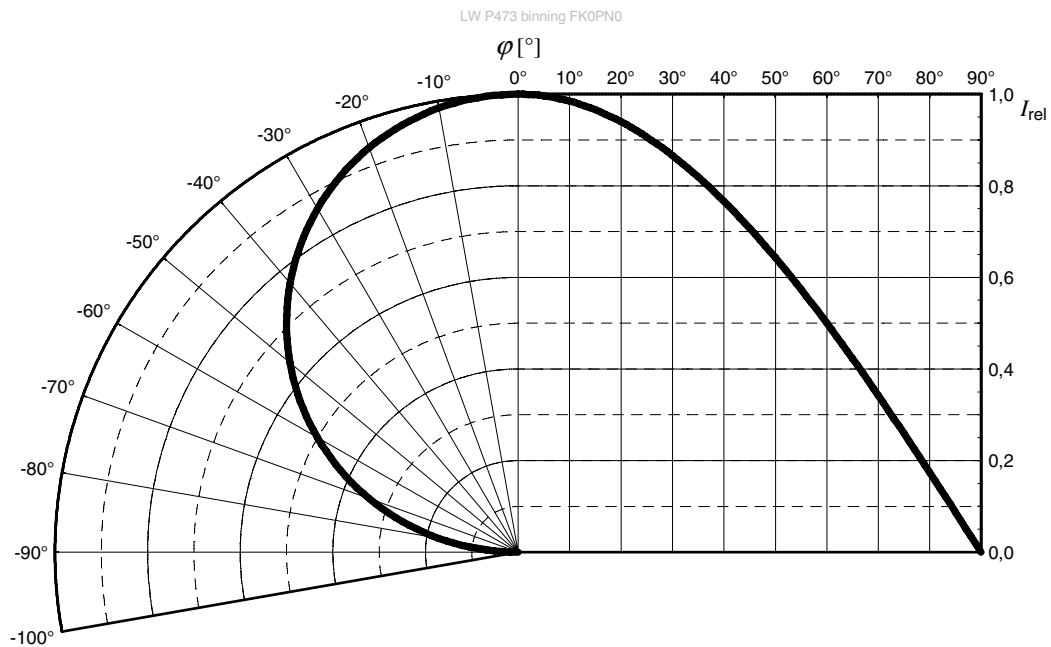

Forward current ⁷⁾

$$I_F = f(V_F); T_S = 25\text{ °C}$$

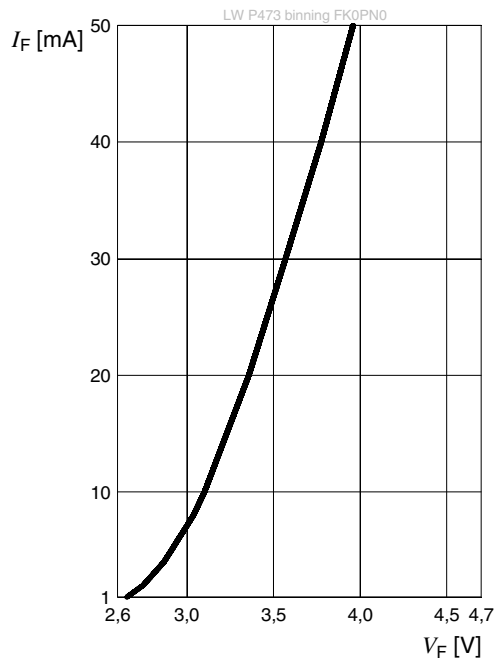

Relative Luminous Intensity ^{7), 8)}

$$I_V/I_V(10\text{ mA}) = f(I_F); T_S = 25\text{ °C}$$

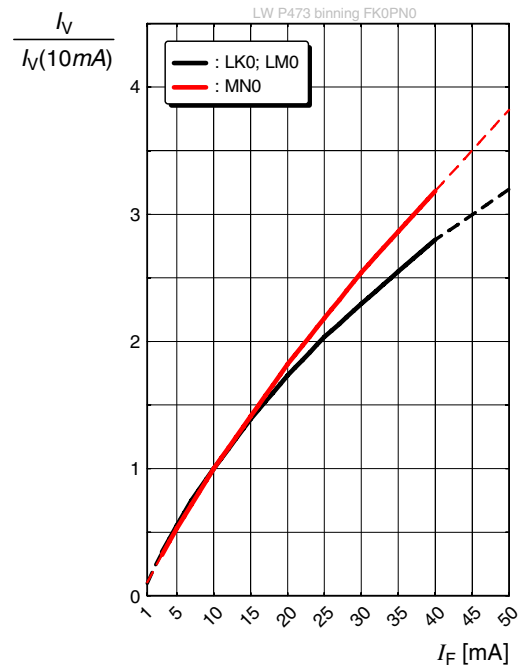

Chromaticity Coordinate Shift ⁷⁾

$$\Delta C_x, \Delta C_y = f(I_F); T_S = 25\text{ °C}$$

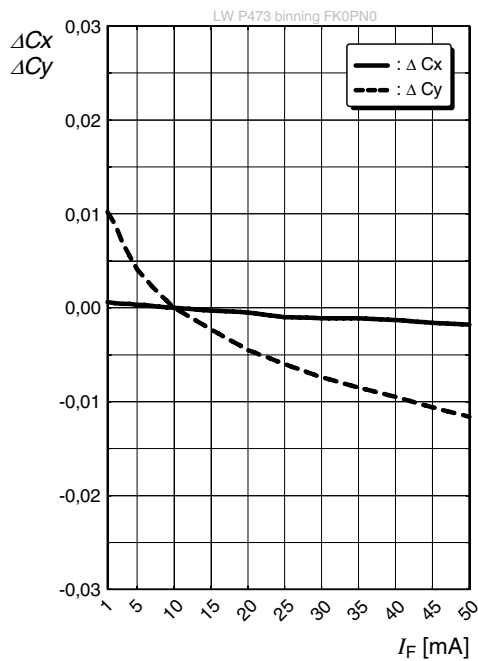

Forward Voltage ⁷⁾

$$\Delta V_F = V_F - V_F(25^\circ\text{C}) = f(T_j); I_F = 10\text{ mA}$$

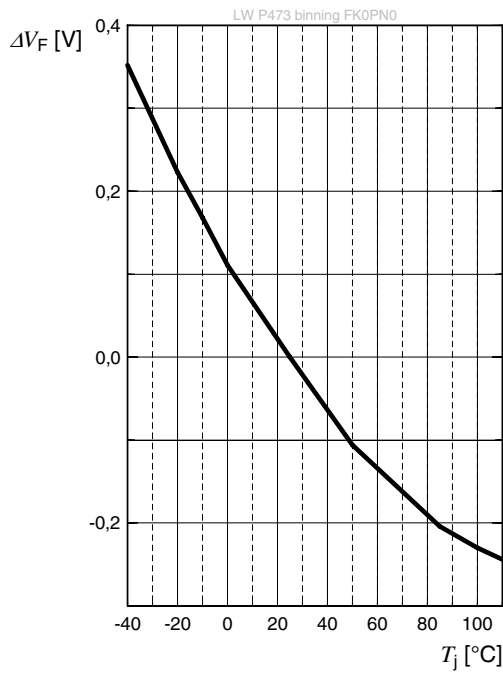

Relative Luminous Intensity ⁷⁾

$$I_V/I_V(25^\circ\text{C}) = f(T_j); I_F = 10\text{ mA}$$

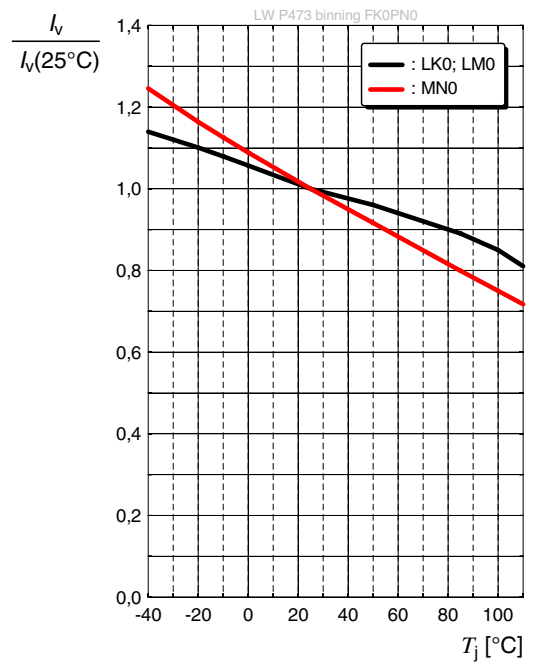

Chromaticity Coordinate Shift ⁷⁾

$$\Delta C_x, \Delta C_y = f(T_j); I_F = 10\text{ mA}$$

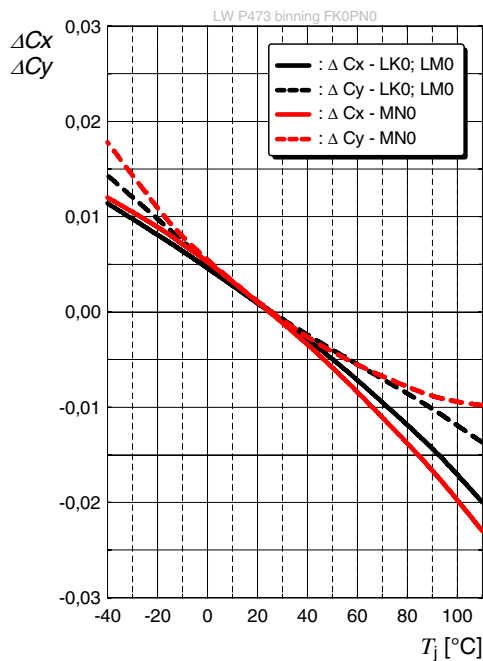

Max. Permissible Forward Current

$I_F = f(T)$

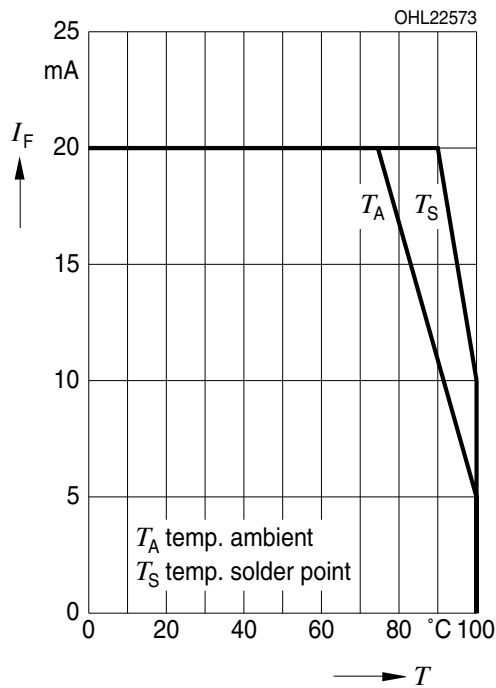

Permissible Pulse Handling Capability

$I_F = f(t_p)$; D: Duty cycle; $T_S = 25\text{ °C}$

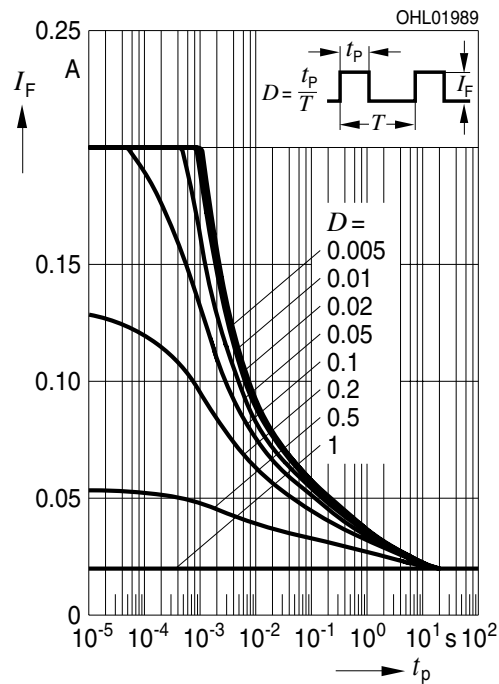

Permissible Pulse Handling Capability

$I_F = f(t_p)$; D: Duty cycle; $T_S = 85\text{ °C}$

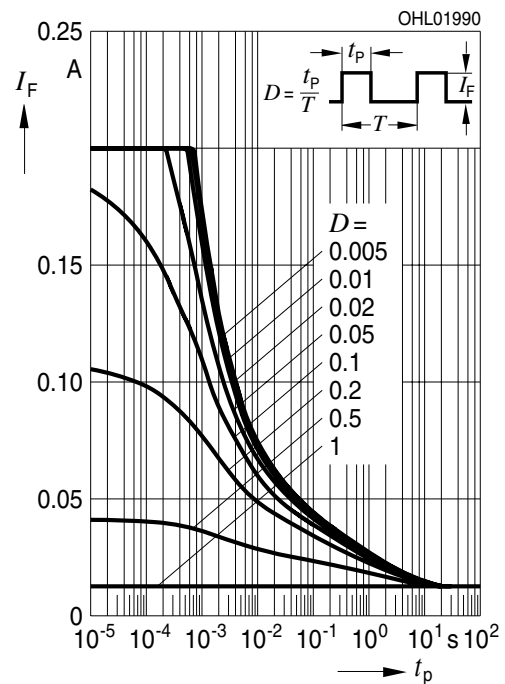

Dimensional Drawing ⁹⁾

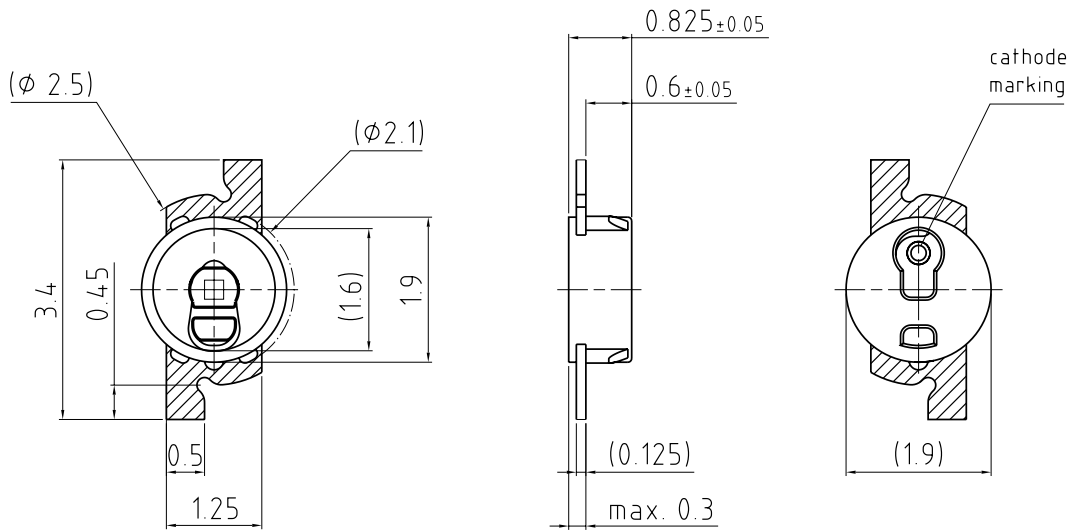

general tolerance ± 0.1

lead finish Sn 

C63062-A3773-A10.. -06

Approximate Weight: 6.0 mg

Corrosion test: Class: 3B
 Test condition: 40°C / 90 % RH / 15 ppm H₂S / 14 days (stricter than IEC 60068-2-43)

Recommended Solder Pad ⁹⁾

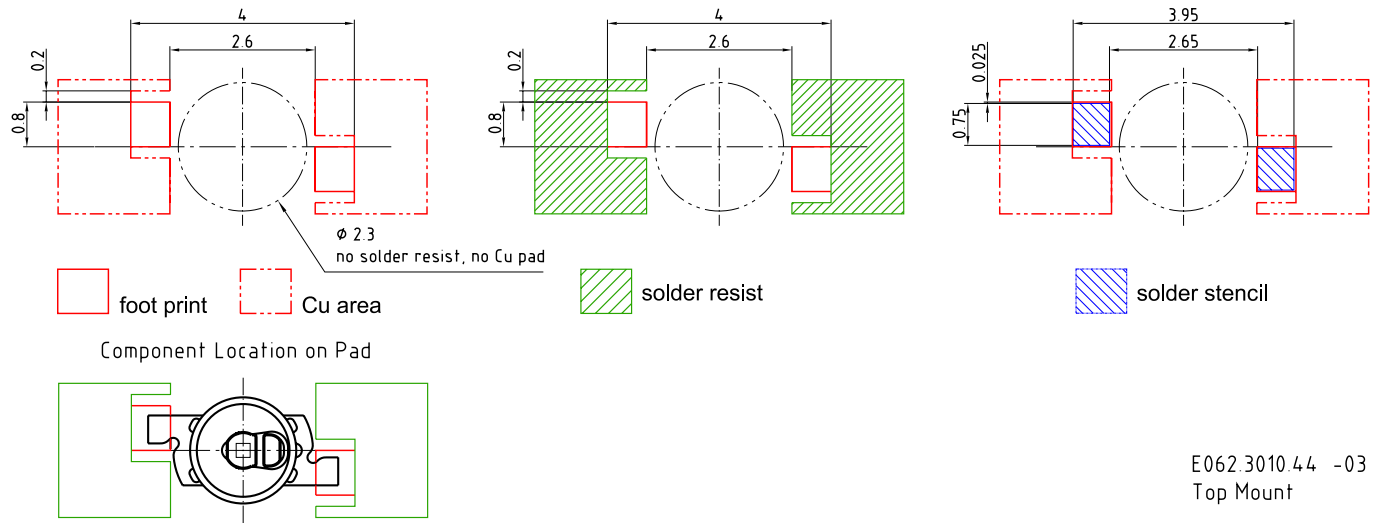

For superior solder joint connectivity results we recommend soldering under standard nitrogen atmosphere. Package not suitable for ultra sonic cleaning.

Recommended Solder Pad ⁹⁾

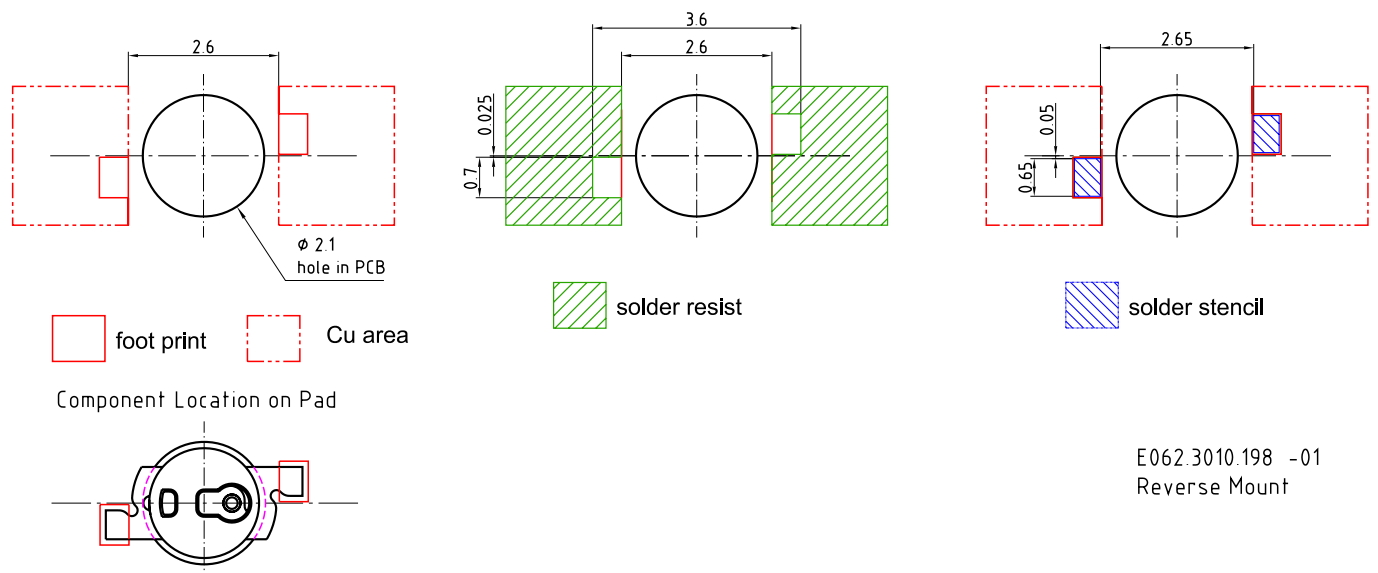

For superior solder joint connectivity results we recommend soldering under standard nitrogen atmosphere. Package not suitable for ultra sonic cleaning.

Reflow Soldering Profile

Product complies to MSL Level 2 acc. to JEDEC J-STD-020E

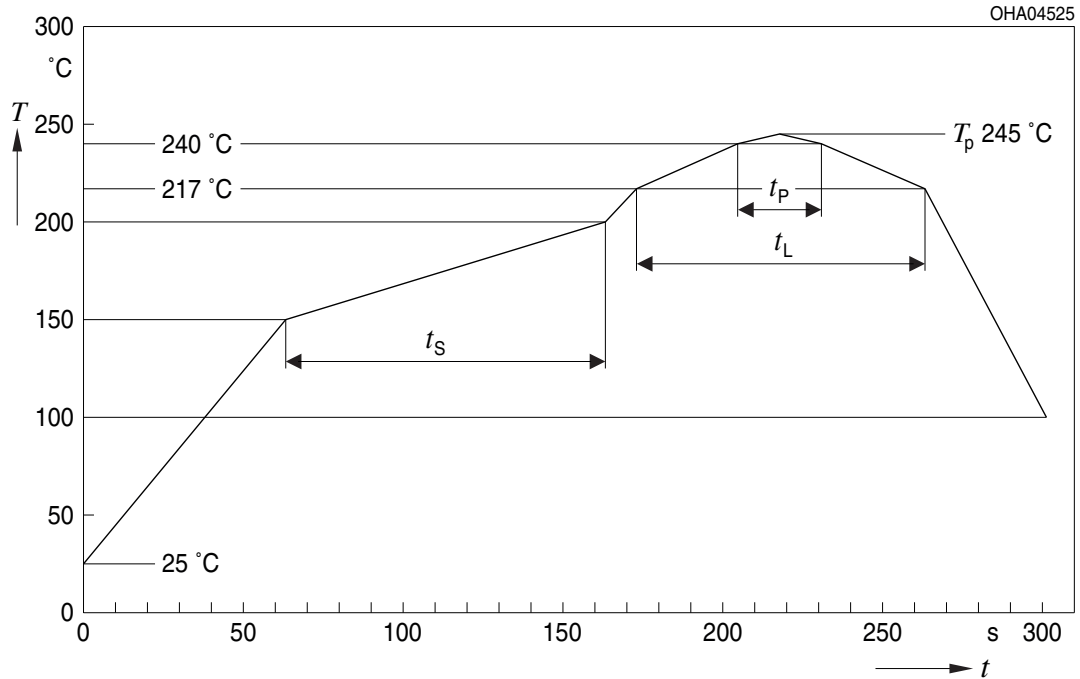

Profile Feature	Symbol	Pb-Free (SnAgCu) Assembly			Unit
		Minimum	Recommendation	Maximum	
Ramp-up rate to preheat*) 25 °C to 150 °C			2	3	K/s
Time t_s T_{Smin} to T_{Smax}	t_s	60	100	120	s
Ramp-up rate to peak*) T_{Smax} to T_p			2	3	K/s
Liquidus temperature	T_L		217		°C
Time above liquidus temperature	t_L		80	100	s
Peak temperature	T_p		245	260	°C
Time within 5 °C of the specified peak temperature $T_p - 5$ K	t_p	10	20	30	s
Ramp-down rate* T_p to 100 °C			3	6	K/s
Time 25 °C to T_p				480	s

All temperatures refer to the center of the package, measured on the top of the component
 *) slope calculation DT/Dt : Dt max. 5 s; fulfillment for the whole T-range

Taping ⁹⁾

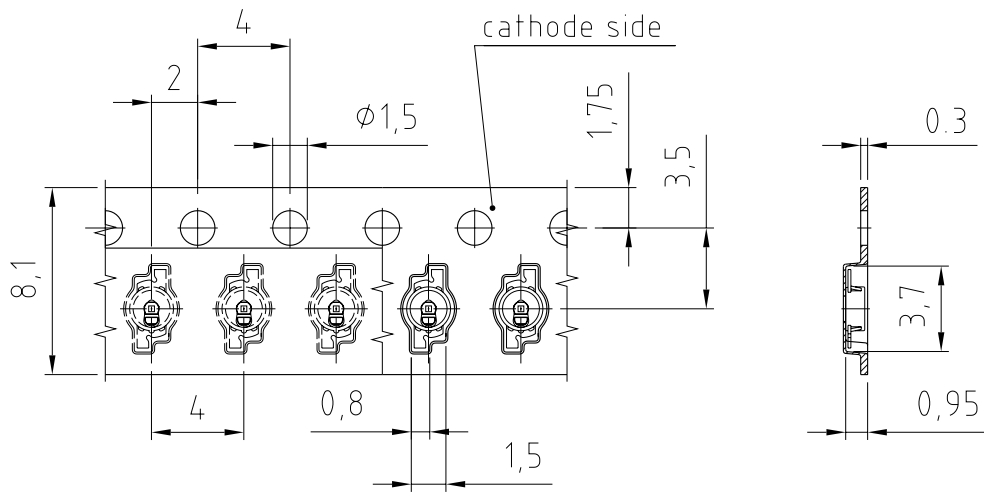

C63062-A3773-B8 -05
Top Mount

Taping ⁹⁾

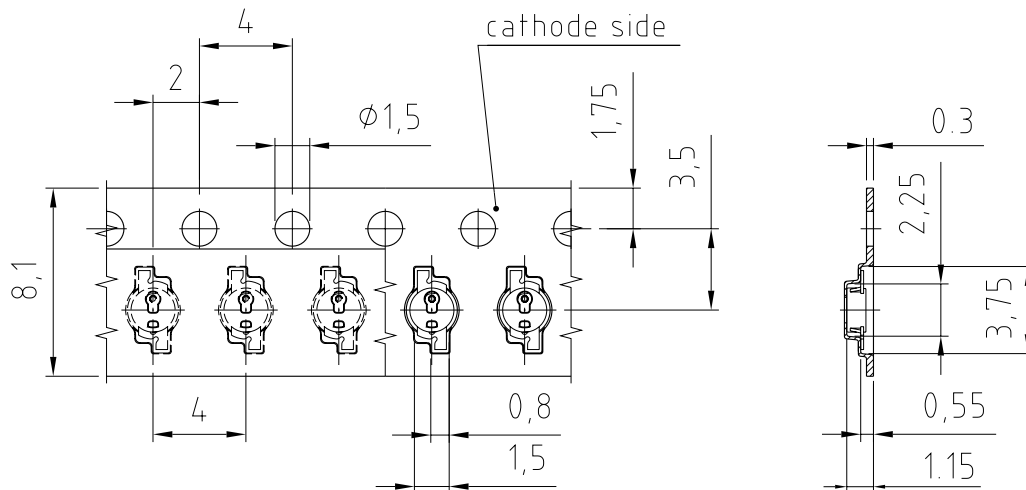

C63062-A3773-B4 -05
Reverse Mount

Tape and Reel ¹⁰⁾

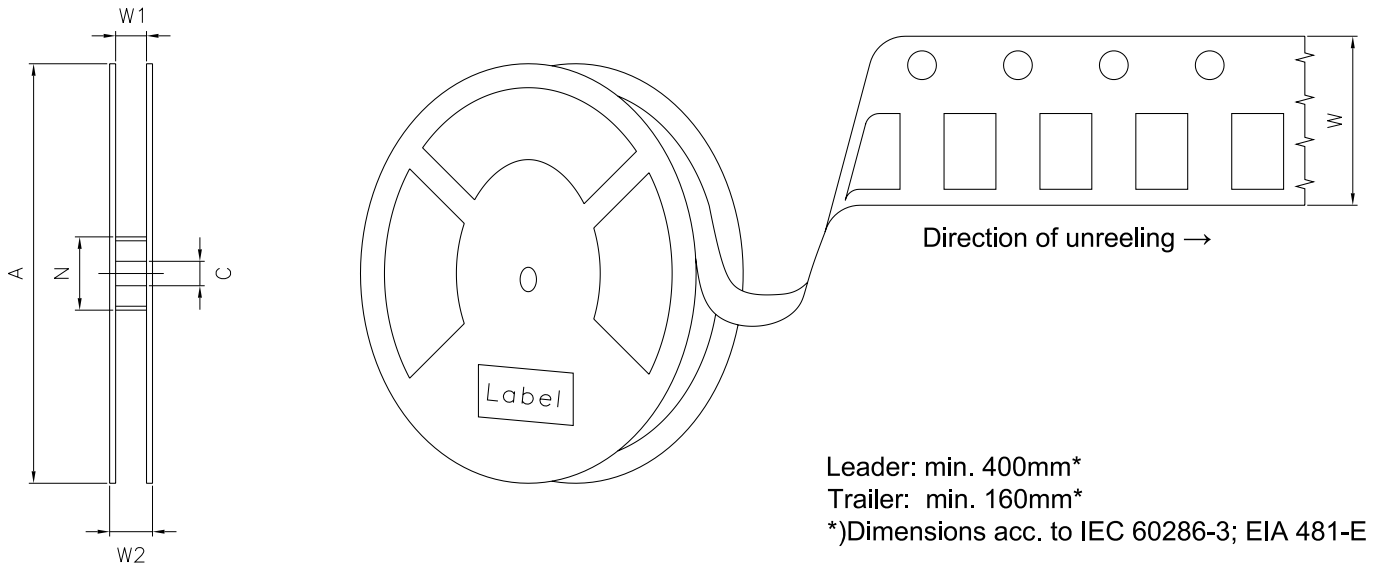

Reel dimensions [mm]

A	W	N _{min}	W ₁	W _{2max}	Pieces per PU
180 mm	8 + 0.3 / - 0.1	60	8.4 + 2	14.4	3000

Barcode-Product-Label (BPL)



Dry Packing Process and Materials ⁹⁾



Moisture-sensitive product is packed in a dry bag containing desiccant and a humidity card according JEDEC-STD-033.

Transportation Packing and Materials ⁹⁾



Dimensions of transportation box in mm

Width	Length	Height
200 ± 5 mm	195 ± 5 mm	30 ± 5 mm

Type Designation System

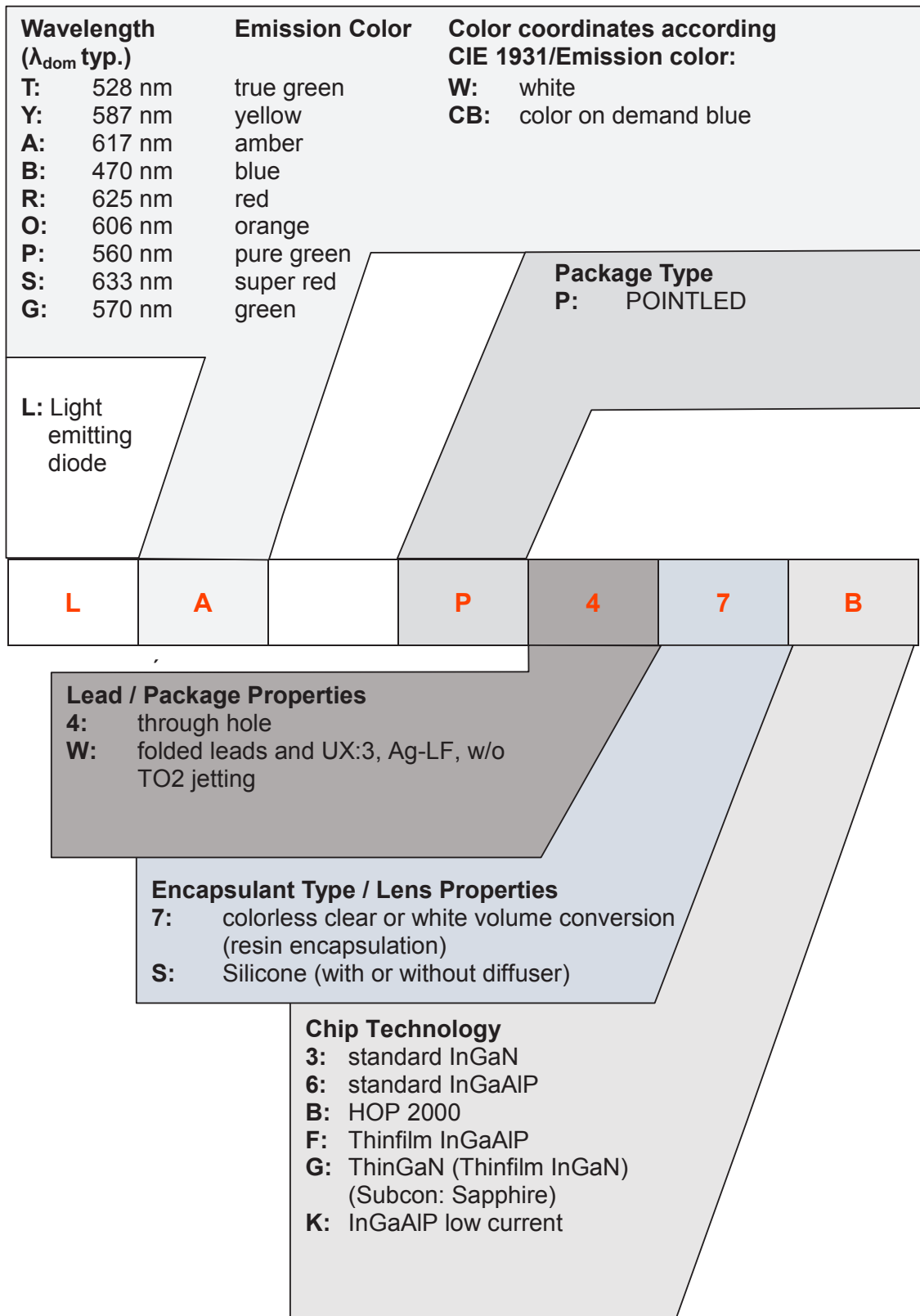

Notes

The evaluation of eye safety occurs according to the standard IEC 62471:2006 (photo biological safety of lamps and lamp systems). Within the risk grouping system of this IEC standard, the device specified in this data sheet falls into the class **exempt group (exposure time 10000 s)**. Under real circumstances (for exposure time, conditions of the eye pupils, observation distance), it is assumed that no endangerment to the eye exists from these devices. As a matter of principle, however, it should be mentioned that intense light sources have a high secondary exposure potential due to their blinding effect. When looking at bright light sources (e.g. headlights), temporary reduction in visual acuity and afterimages can occur, leading to irritation, annoyance, visual impairment, and even accidents, depending on the situation.

Subcomponents of this LED contain, in addition to other substances, metal filled materials including silver. Metal filled materials can be affected by environments that contain traces of aggressive substances. Therefore, we recommend that customers minimize LED exposure to aggressive substances during storage, production, and use. LEDs that showed visible discoloration when tested using the described tests above did show no performance deviations within failure limits during the stated test duration. Respective failure limits are described in the IEC60810.

For further application related informations please visit www.osram-os.com/appnotes

Disclaimer

Disclaimer

Language english will prevail in case of any discrepancies or deviations between the two language wordings.

Attention please!

The information describes the type of component and shall not be considered as assured characteristics. Terms of delivery and rights to change design reserved. Due to technical requirements components may contain dangerous substances.

For information on the types in question please contact our Sales Organization.

If printed or downloaded, please find the latest version on the OSRAM OS website.

Packing

Please use the recycling operators known to you. We can also help you – get in touch with your nearest sales office.

By agreement we will take packing material back, if it is sorted. You must bear the costs of transport. For packing material that is returned to us unsorted or which we are not obliged to accept, we shall have to invoice you for any costs incurred.

Product safety devices/applications or medical devices/applications

OSRAM OS components are not developed, constructed or tested for the application as safety relevant component or for the application in medical devices.

In case Buyer – or Customer supplied by Buyer– considers using OSRAM OS components in product safety devices/applications or medical devices/applications, Buyer and/or Customer has to inform the local sales partner of OSRAM OS immediately and OSRAM OS and Buyer and /or Customer will analyze and coordinate the customer-specific request between OSRAM OS and Buyer and/or Customer.

Glossary

- 1) **Brightness:** Brightness values are measured during a current pulse of typically 25 ms, with an internal reproducibility of $\pm 8\%$ and an expanded uncertainty of $\pm 11\%$ (acc. to GUM with a coverage factor of $k = 3$).
- 2) **Reverse Operation:** Reverse Operation of 10 hours is permissible in total. Continuous reverse operation is not allowed.
- 3) **Chromaticity coordinate groups:** Chromaticity coordinates are measured during a current pulse of typically 25 ms, with an internal reproducibility of ± 0.005 and an expanded uncertainty of ± 0.01 (acc. to GUM with a coverage factor of $k = 3$).
- 4) **Forward Voltage:** The forward voltage is measured during a current pulse of typically 8 ms, with an internal reproducibility of $\pm 0.05\text{ V}$ and an expanded uncertainty of $\pm 0.1\text{ V}$ (acc. to GUM with a coverage factor of $k = 3$).
- 5) **Thermal Resistance:** $R_{th\ max}$ is based on statistic values (6σ).
- 6) **Thermal Resistance:** R_{thJA} results from mounting on PC board FR 4 (pad size 16 mm^2 per pad)
- 7) **Typical Values:** Due to the special conditions of the manufacturing processes of semiconductor devices, the typical data or calculated correlations of technical parameters can only reflect statistical figures. These do not necessarily correspond to the actual parameters of each single product, which could differ from the typical data and calculated correlations or the typical characteristic line. If requested, e.g. because of technical improvements, these typ. data will be changed without any further notice.
- 8) **Characteristic curve:** In the range where the line of the graph is broken, you must expect higher differences between single devices within one packing unit.
- 9) **Tolerance of Measure:** Unless otherwise noted in drawing, tolerances are specified with ± 0.1 and dimensions are specified in mm.
- 10) **Tape and Reel:** All dimensions and tolerances are specified acc. IEC 60286-3 and specified in mm.

Published by OSRAM Opto Semiconductors GmbH
Leibnizstraße 4, D-93055 Regensburg
www.osram-os.com © All Rights Reserved.

EU RoHS and China RoHS compliant product



此产品符合欧盟 RoHS 指令的要求；
按照中国的相关法规和标准，不含有毒有害物质或元素。



Компания «ЭлектроПласт» предлагает заключение долгосрочных отношений при поставках импортных электронных компонентов на взаимовыгодных условиях!

Наши преимущества:

- Оперативные поставки широкого спектра электронных компонентов отечественного и импортного производства напрямую от производителей и с крупнейших мировых складов;
- Поставка более 17-ти миллионов наименований электронных компонентов;
- Поставка сложных, дефицитных, либо снятых с производства позиций;
- Оперативные сроки поставки под заказ (от 5 рабочих дней);
- Экспресс доставка в любую точку России;
- Техническая поддержка проекта, помощь в подборе аналогов, поставка прототипов;
- Система менеджмента качества сертифицирована по Международному стандарту ISO 9001;
- Лицензия ФСБ на осуществление работ с использованием сведений, составляющих государственную тайну;
- Поставка специализированных компонентов (Xilinx, Altera, Analog Devices, Intersil, Interpoint, Microsemi, Aeroflex, Peregrine, Syfer, Eurofarad, Texas Instrument, Miteq, Cobham, E2V, MA-COM, Hittite, Mini-Circuits, General Dynamics и др.);

Помимо этого, одним из направлений компании «ЭлектроПласт» является направление «Источники питания». Мы предлагаем Вам помощь Конструкторского отдела:

- Подбор оптимального решения, техническое обоснование при выборе компонента;
- Подбор аналогов;
- Консультации по применению компонента;
- Поставка образцов и прототипов;
- Техническая поддержка проекта;
- Защита от снятия компонента с производства.



Как с нами связаться

Телефон: 8 (812) 309 58 32 (многоканальный)

Факс: 8 (812) 320-02-42

Электронная почта: org@eplast1.ru

Адрес: 198099, г. Санкт-Петербург, ул. Калинина, дом 2, корпус 4, литера А.