

Introduction

Communication Satellite Frequency Allocation

Communication satellites operate within two frequency bands for TV/Broadband service broadcast signals, C Band and Ku Band. The C Band overall frequency spectrum is 4.0GHz -8.0GHz, while the Ku Band overall frequency spectrum is 11.7GHz -18.0GHz.

Within these bands each satellite will have specific uplink and downlink frequency allocation. For example the North American DBS system has categories assigned as follows, Ku Band high power downlink is 12.2GHz-12.7GHz and 17.3GHz-17.8GHz as the uplink frequency, C Band downlink frequency is 3.7GHz-4.2GHz and 5.925GHz-6.425GHz as uplink frequency.

Also, to use the frequencies that are available for satellite broadcast as efficiently as possible, and to accommodate an additional number of channels within a given frequency band, the transmission signal can be formatted to be either vertical and horizontal, or circular right-hand and circular left-hand simultaneously per frequency.

What is a Low Noise Block (LNB)?

An LNB is a low noise block module, placed on the focus of the dish antenna (parabola) that provides the following functions:

- Down conversion of the incoming signal from GHz range to the 910MHz-2150MHz (for Europe) range called "first conversion signal." This conversion allows the signal to be carried by an inexpensive coaxial cable towards the receiver.
- Signal amplification with good noise figure. The LNB improves the first conversion signal level through the use of a built-in low noise amplifier.
- Selection of Vertical or Horizontal polarization.
- Selects operating band by switching its internal oscillator from Low band to High band when the LNB "receives" a 22kHz tone. Specifically, the local oscillator (LO) frequency changes from 9.75GHz to 10.6GHz.
C Band - LO frequency 9.75GHz
Ku Band - LO frequency 10.6GHz
- Miscellaneous functions based on 22kHz tone PPM encoding, as discussed later in this paper.

Polarization Selection

Polarization is a way to give a transmission signal specific direction. It increases the beam concentration. The signal transmitted by satellite can be polarized in one of four different ways: Linear (horizontal or vertical) or Circular

(right-hand or left-hand). Consequently, the satellite can broadcast both H and V or LH and RH polarized signals on one frequency.

The "universal" LNB switches the polarization by looking at the voltage that it receives from the receiver.

12V – Horizontal, 18V – Vertical

13V – Circular right-hand, 20V – Circular left-hand

Generally, only two (12V and 18V or 13V and 20V) will be used with one type of antenna. Also, 1V can be added from a receiver to any of above voltages to compensate for the voltage drop in the coaxial cable, i.e., it could be 13V (12V), 14V (13V), 19V (18V) or 21V (20V) instead.

22kHz Tone and DiSEqC (Digital Satellite Equipment Control) Encoding

In addition to selecting the polarization, the LNB needs to select the operating band. This is done with the use of a 22kHz tone frequency. A 22kHz pulse-position modulated signal of about 0.6V amplitude is superimposed on the LNB's DC power rail. Its coding scheme allows the remote electronics to perform more complex functions like varying the down conversion frequency to select one of multiple LNB's for dual-dish systems or physically rotating the antenna assembly. Traditionally, when other encoding functions do not require using 22kHz tone, simple presence or absence of this tone selects the operating band by changing the local oscillator frequency of the LNB.

The complex encoding of the 22kHz burst is done with a more sophisticated communication bus protocol named the DiSEqC standard (Digital Satellite Equipment Control). The open DiSEqC standard developed by the European Telecommunication Satellite Organization is a well accepted worldwide standard for communication between satellite receivers and satellite peripheral equipment.

The 22kHz oscillator has to be a tone generator with specific rise and fall time. The wave shape will be a quasi-square wave (sine with flat-top). The required frequency tolerance is $\pm 2\text{kHz}$ over line and temperature variations. Burst coding of this signal is accomplished by input from the microcontroller at the DSQIN pin of the IC or by setting the ENT bit of the system register through the I²C bus as detailed in the ISL6421, ISL6425 datasheets.

22kHz WAVE SHAPE AND DETAILS (See Figures 1 and 2)

Carrier frequency: 22kHz $\pm 2\text{kHz}$ over line and temperature

Carrier amplitude: 650mVpp $\pm 250\text{mV}$

Modulation mark period: 500 μs $\pm 100\mu\text{s}$

Modulation space period: 1ms $\pm 200\mu\text{s}$

Methods of Modulation

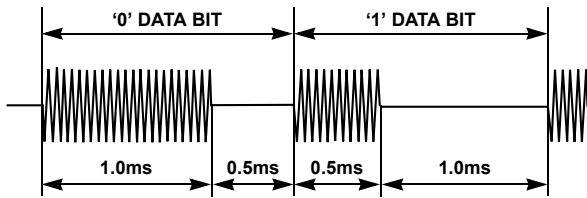

FIGURE 1. DiSEqC MODULATION SCHEME

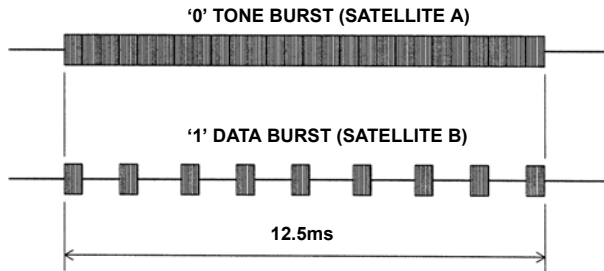

FIGURE 2. TIMING DIAGRAM FOR TONE BURST CONTROL SIGNAL

ISL6421/ISL6425 - Provides a Complete Power Solution for LNB Control

The ISL6421/ISL6425 is a highly integrated solution for supplying power and control signals from advanced satellite set-top box (STB) modules to the low noise block (LNB) of the antenna port. The devices are comprised of a current-mode boost PWM and a low-noise linear regulator along with the circuitry required for I²C device interfacing and for providing DiSEqC standard control signals to the LNB.

The regulator output voltage is available at the output terminal (VOUT) to support operation of the antenna port in advanced satellite STBs. The regulator output for the PWM is set to 13V or 18V by a voltage select command (VSEL) through the I²C bus. Additionally, to compensate for the voltage drop in the coaxial cable, the selected voltage may be increased by 1V with the line length compensation (LLC) feature. An enable command sent on the I²C bus provides standby mode control for the PWM and linear combination, disabling the output to conserve power.

The current-mode boost converter provides the linear regulator with input voltage that is set to the output voltage, plus typically 1.2V dropout to insure minimum power dissipation across the linear regulator. This maintains constant voltage drop across the linear pass element while permitting adequate voltage range for tone injection.

Please refer to the ISL6421 datasheet (FN9130), or ISL6425 datasheet (FN9176), for more information.

Quick Start Evaluation

Out Of The Box

The ISL6421/ISL6425 evaluation board is shipped in a “ready-to-test” state. The board requires an input voltage ranging from 8V to 14V and a 3.3V/5V supply. The use of an electronic load enables evaluation over a wide range of operating conditions. The evaluation kit also includes 5 samples of the ISL6421ER/ISL6425ER, a PC to I²C bus interface board (USB-I2CIO), PC to I²C bus software, a USB cable, and a connector cable to connect the USB-I2CIO board and the ISL6421EVAL1A/ISL6425EVAL2 board.

TABLE 1. ISL6421/ISL6425 EVALUATION BOARDS

BOARD NAME	IC	PACKAGE
ISL6421EVAL1A	ISL6421ER	32 Ld QFN
ISL6425EVAL2	ISL6425ER	32 Ld QFN

Required Test Equipment

To fully test the ISL6421/ISL6425 functionality, the following equipment is needed:

- 4 channel oscilloscope with probes
- 1 electronic load
- 2 bench power supplies
- Precision digital multimeters
- I²C bus read/write capability

Power and Load Connections

The ISL6421/ISL6425 evaluation board has three sets of terminal posts used to supply the input voltages and to monitor and load the outputs.

Jumper Settings ISL6421 - JP1, JP2, and JP3 will be shorted with shunt jumpers pulling the ADDR, SEL18V, and the DISQIN pins low.

Jumper Settings ISL6425 - JP1, JP2 short V_{IN} supply to V1 and Q1. JP3 short to set ADDRs low.

Input Voltage - Adjust two power supplies to provide the 5V/3.3V and 12V input voltages of the evaluation board. With the power supplies turned off, connect the positive lead of the 12V supply to the VIN post (P1) and the ground lead to the GND post (P2).

The second supply set for either 5V or 3.3V provides the pull-up voltage for the I²C bus clock and data line. Connect the positive lead of the second supply to the +5V/+3.3V post (P7)/ISL6421 or (P5)/ISL6425 and the ground lead to the SGND post (P8)/ISL6421 or (P6)/ISL6425.

Output Voltage Loading and Monitoring - To exercise and monitor VOUT, connect the positive lead of one of the electronic loads and the positive lead of a digital multimeter to the VOUT post (P3) and the ground lead to the GND post (P4).

I²C Bus Communication Setup

To control and exercise the ISL6421/ISL6425 requires communication through the I²C bus clock (SCL) and data (SDA) pins. Refer to the ISL6421, ISL6425 datasheets for more information about the I²C bus specification. You can use existing I²C hardware/software, a word generator, or use the PC to I²C hardware/software included in the ISL6421/ISL6425 evaluation kit to produce the necessary I²C waveforms.

USB-I2CIO Board Driver Installation - To use a PC to control the I²C bus to communicate with the ISL6421/ISL6425 you will have to install the drivers of the USB-I2CIO board included in the kit. You will need a Windows 98/XP/2000 machine with a standard USB port.

1. The evaluation kit comes with a CD containing the software and drivers to control the I²C bus. Copy the contents of the CD to some directory, e.g., C:\some directory'.
2. Applying power to the USB-I2CIO board: The USB-I2CIO board has the option of being powered with 3.3V through the USB bus of the PC or externally with 5V connected to the +5 test point and GND test point. The I²C bus can operate at 3.3V or 5V logic levels. If you use an external 5V supply then place a shunt jumper shorting pins 2 and 3 of JP3. If you are using an external 5V supply to power the USB-I2CIO board, place a shunt jumper shorting pins 1 and 2 of JP3.
3. After the USB-I2CIO board is powered up, connect the USB cable to the USB port of a PC.
4. Windows should detect the new USB device and the 'Found New Hardware Wizard' should begin. This will help you install the drivers. Follow the directions on the screen until it asks you where to search for the drivers. At this point, you should select the 'choose location' option and browse to the C:\some directory' created in step one and select the drivers folder.
5. Follow the remaining directions and the driver should be installed and the USB-I2CIO detected by your PC.
6. If this is successful, another 'Found New Hardware Wizard' window will appear. Repeat steps 4 and 5. At this point, the USB-I2CIO board should be ready to use.
7. To connect the USB-I2CIO board to the ISL6421/ISL6425 evaluation board, use the 5-pin to 4-pin connector cable. Connect the 5-pin connector to J4 on the USB-I2CIO board and the 4-pin connector to J1 on the ISL6421/ISL6425 evaluation board.
8. Turn on the power supplies to power up the ISL6421/ISL6425 evaluation board.
9. Run the ISL6421&25_I2C_reva.exe program copied to C:\some directory'. Figure 3 shows the PC to I²C software application window. Click the 'Open Device' button.

10. If you receive a 'No USB Device Detected' error:
 - Make sure the drivers were installed correctly. If Windows did not detect your USB device, try running the Add/Remove Hardware Wizard in the control panel.
 - Make sure the USB board is powered up (internally or externally, not both).
11. If you receive the 'Incorrect Return Value' error:
 - The ISL6421/ISL6425 evaluation board may not be powered up. Check the power connections.
 - Make sure SCL and SDA are connected correctly. The 5-pin connector to the USB-I2CIO board only fits one way. Try reversing the 4-pin connector at J1 of the ISL6421/ISL6425 evaluation board.

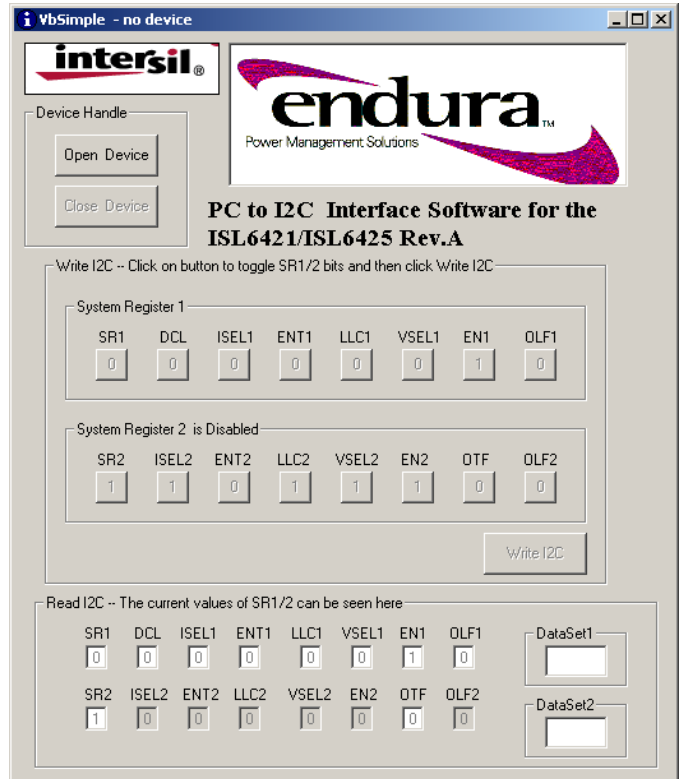

FIGURE 3. PC TO I²C APPLICATION WINDOW

Using the PC to I²C Application

After opening the application window and clicking on the 'Open Device' button, the program will detect the USB-I2CIO board and initialize the I²C system registers of the ISL6421/ISL6425. To evaluate the ISL6421/ISL6425 functionality, toggle the system register bits as needed and then click on the 'Write I2C' button to write to the system registers. The lower portion of the application window shows the current values of the system register bits. They are read and updated continuously. The OLF1 and OTF flag in system register 1 and 2 are read only bits and provide diagnostic status of the ISL6421/ISL6425.

Performance Characterization

Start-up

The ISL6421/ISL6425 features internal soft-start to reduce the external number of components. Figure 4 shows a typical soft-start waveform. Typical soft-start time is 4.6ms.

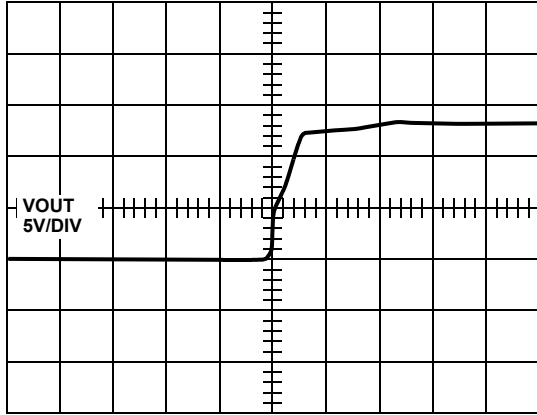

FIGURE 4. SOFT START

Shutdown

The LNB output of the ISL6421/ISL6425 can be shut down using the EN bit via I²C. Figure 5 shows a typical shutdown waveform.

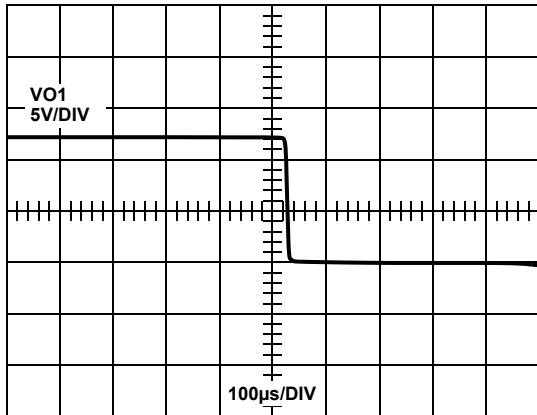

FIGURE 5. SHUTDOWN USING I²C ENABLE

Boost PWM Efficiency

The Boost PWM architecture allows close to 90% efficiency at full load as shown in Figure 6.

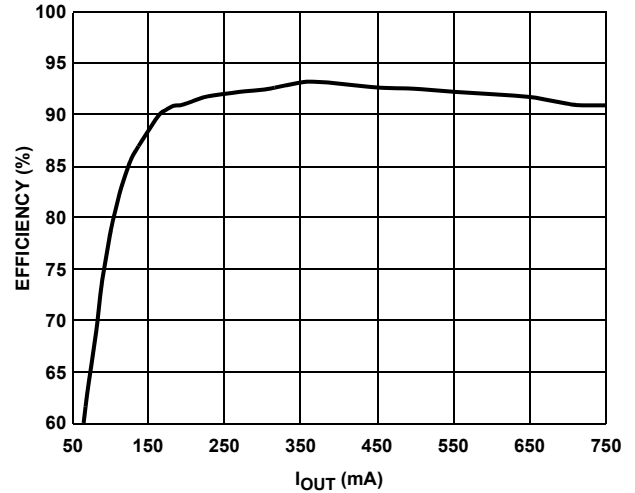

FIGURE 6. BOOST PWM EFFICIENCY vs LOAD

DiSEqC Implementation

The ISL6421/ISL6425 has a built-in 22kHz tone generator that can be controlled either by the I²C interface or by a dedicated pin (DSQIN) that allows immediate DiSEqC data encoding for the DiSEqC compliance. When the I²C tone enable bit (ENT) is set to HIGH, a continuous 22kHz tone is generated regardless of the status of the DSQIN pin. The ENT pin must be LOW when DSQIN pin is being used for DiSEqC encoding. Figure 7 shows the 22kHz tone waveform with 450mA load.

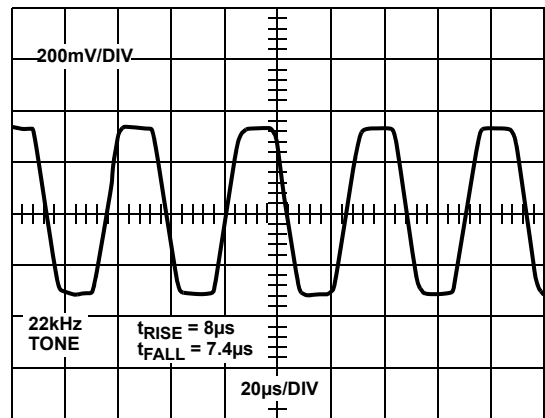

FIGURE 7. 22kHz TONE OPERATION

Overcurrent Hiccup Mode

Figure 8 shows a typical overcurrent trip.

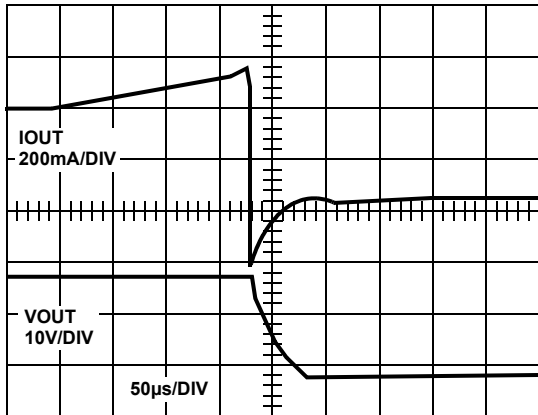

FIGURE 8. OVERCURRENT TRIP

When the DCL (dynamic current limiting) bit is set LOW, the overcurrent protection circuit works dynamically in a hiccup mode; as soon as an overload is detected, the output is shutdown for a time t_{OFF} , typically 900ms. The output is resumed for a time $t_{ON} = 20ms$. At the end of t_{ON} , if the overload condition is still detected, the protection circuit will cycle again through t_{OFF} and t_{ON} . Figure 9 shows the typical waveforms for the overcurrent hiccup mode.

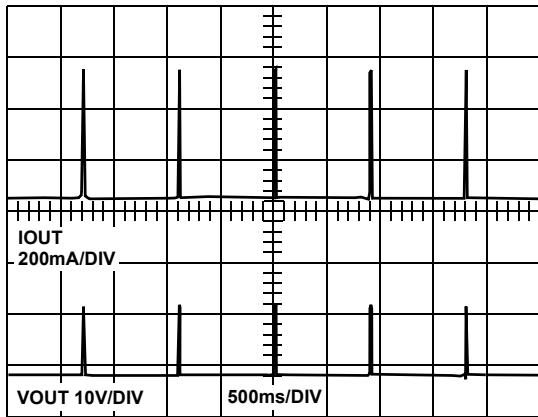

FIGURE 9. OVERCURRENT HICCUP MODE

Output Ripple

Figure 10 shows the typical output ripple waveforms. VOUT is set to 13V and 450mA load.

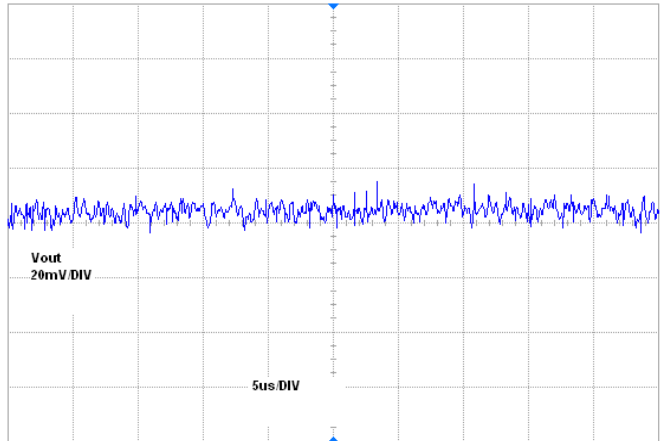

FIGURE 10. OUTPUT RIPPLE

External Back-Bias Protection

Some applications may need to be able to protect the ISL6421/ISL6425 from an inadvertent back-bias voltage condition. For the case where a DC supply is connected to the output of the ISL6421/ISL6425, a series connected diode as shown in Figure 11 will protect the IC. The LLC bit can be set high through the I²C bus to increase the output voltage by 1V to compensate for the diode voltage drop.

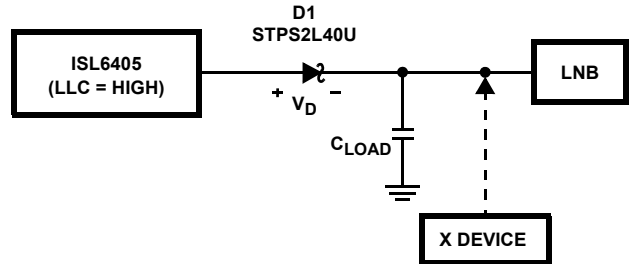

FIGURE 11. DC BACK-BIAS PROTECTION CIRCUIT

The DiSEqC standard recommends a maximum bus load of $0.25\mu F$. For the circuit in Figure 11 to provide proper 22kHz tone operation, the bus would have to have a minimum loading of 12mA.

If tone operation is required at zero load conditions, a resistor can be placed from the cathode of the protection diode to ground, scaled to provide the minimum 12mA. To avoid the added dissipation of this method, a capacitor can be placed in parallel with the back-bias protection diode as shown in Figure 12. This capacitor should be scaled with the capacitive load present on the DiSEqC bus line. For a load of $0.25\mu F$, use a $10\mu F$ capacitor. Consider the maximum load of $0.25\mu F$ and the highest output voltage of 19V and a 0.5V drop across the Schottky diode. After the tone rise time,

$$Q_d(\text{rise}) \sim 0, Q_{\text{load}}(\text{rise}) = 19V \cdot 0.25\mu F = 4750nC$$

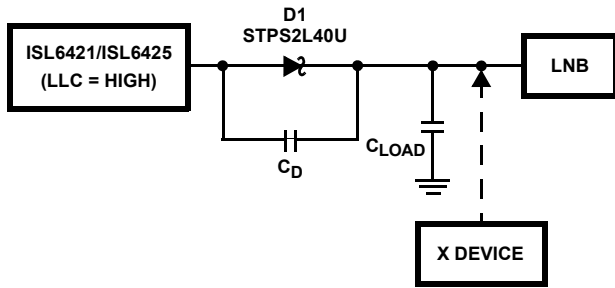

FIGURE 12. DC BACK-BIAS PROTECTION CIRCUIT FOR ZERO LOAD CONDITION

During the tone fall time, the capacitors are essentially in series so the charge will try to equally distribute between C_D and C_{LOAD} . C_{LOAD} will discharge allowing current to flow to C_D to match the falling voltage at the anode of the diode. You will have to choose a capacitor, C_D , that is large enough to absorb the C_{LOAD} discharging current and to minimize the voltage drop created during the minimum tone fall time specification, $5\mu s$. A good choice would be to use a capacitor for C_D that is 40 times the value of C_{LOAD} .

Figure 13 shows the tone mode operation at the cathode of the protection diode in a zero load condition and the charging current between C_D and C_{LOAD} . Large current transients may occur from a fast dV/dt created if a DC supply were connected to the output of the ISL6421/ISL6425, therefore, to use the circuit in Figure 13, the DC supply would have to be limited to 1A maximum current during the dV/dt voltage transient to fully protect the IC.

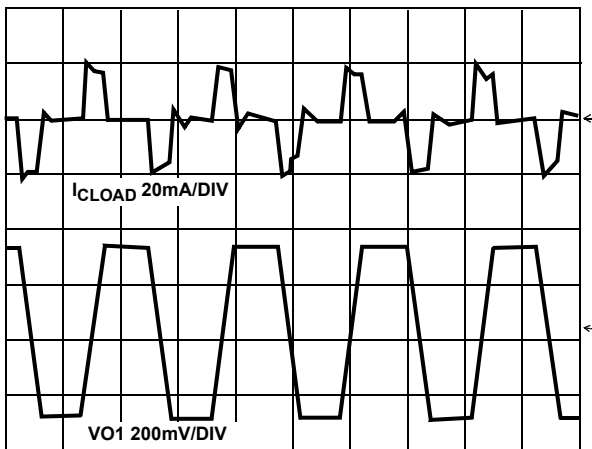

FIGURE 13. ZERO LOAD 22kHz TONE AT CATHODE OF DIODE AND DRIVING CURRENT CHARGING AND DISCHARGING C_{LOAD}

Component Selection Guidelines

The ISL6421EVAL1A/ISL6425EVAL2 application schematics show the configuration for a single LNB power supply.

TCAP Capacitor

A capacitor connected to the TCAP pin sets the transition time from 13V to 18V. A $1\mu F$ minimum capacitor is recommended for smooth transition with reduced peak currents. Figure 14 shows the transition time versus capacitor value.

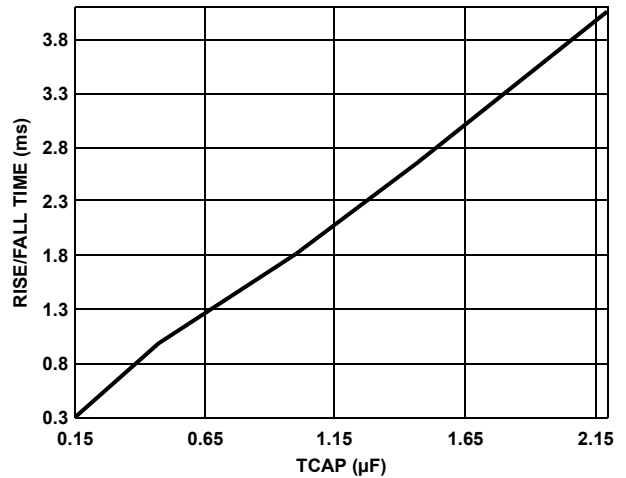

FIGURE 14. TCAP CAPACITOR VALUE vs OUTPUT TRANSITION TIME

The programmable output voltage rise and fall times can be set by an external capacitor. The output rise and fall times will be approximately 3400 times the TCAP value. For the recommended range of $0.47\mu F$ to $2.2\mu F$, the rise and fall time would be 1.6ms to 7.6ms. Use of a $0.47\mu F$ capacitor insures the PWM will stay below its overcurrent threshold when charging a $120\mu F$ VSW filter cap during the worst case 13V to 19V transition. This feature only affects the turn-on and programmed voltage rise and fall times. Figure 15 shows the 13V to 18V transition with $TCAP = 1\mu F$.

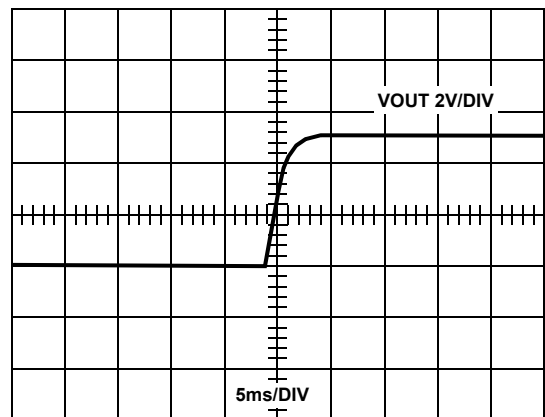

FIGURE 15. 13V TO 18V TRANSITION

Inductor

The ISL6421/ISL6425 operates with a 33µH standard inductor over the entire range of supply voltages and load currents. Choose an inductor that can handle at least the peak switch current without saturating, and ensure that the inductor has a low DCR (series resistance) to maximize efficiency. The inductor saturation current must be greater than the switch peak current,

$$I_{PEAK} = \frac{V_{SW(max)} \cdot I_{OUT}}{n \cdot V_{IN(min)}} + \frac{V_{IN(min)}}{2L \cdot f_{SW}} \left(1 - \frac{V_{IN(min)}}{V_{SW(max)}} \right) \quad (EQ. 1)$$

where,

L = Inductance, 33µH

f_{SW} = PWM switching frequency, 220kHz Typical

n = Efficiency, 92% at maximum load

TABLE 2. RECOMMENDED INDUCTORS

VENDOR	PART NUMBER	ISAT (A)	DCR (mΩ)	PACKAGE
Coilcraft	MSS-1260-333MX	2.2	75	SMD
Falco	SD1016	2.8	66	SMD

Output Capacitors

The most important parameter for the output capacitors is effective series resistance (ESR). The output ripple is directly proportional to output capacitor ESR value.

A 68µF or less aluminum electrolytic output filter capacitor with ESR lower than 80mΩ in parallel with a 470nF ceramic capacitor is a good choice in most application conditions. The ceramic capacitor is necessary to reduce the high frequency switching noise.

A high output capacitance and low ESR will strongly reduce the output ripple voltage and output switching noise and will improve efficiency. Use the lowest possible ESR capacitor for best performance.

The maximum value output capacitor is restricted by transition time specifications between 13V to 18V. With a high output capacitor the boost circuit will need higher peak current from input supply to make transition from 13V to 18V in a given transition time as set by TCAP value. Figure 14 shows the TCAP capacitor value versus transition time. Use high TCAP capacitor value for high output capacitors to allow sufficient time to charge the output capacitors in maximum load conditions.

The capacitor’s voltage rating should be at least 35V, but higher voltage electrolytic capacitors generally have lower

ESR numbers, and for this reason, to improve efficiency and output ripple, select a capacitor with higher voltage ratings.

TABLE 3.

VENDOR	SERIES	PACKAGE
Sanyo	OS-CON Electrolytic	SMD/Through hole
Panasonic	EEUPC Electrolytic	TH
Nichicon	PL Electrolytic	TH

Sense Resistor

The current sense resistor provides current loop feedback and sets the overcurrent limit for static current mode. This resistor value is calculated based on peak switch current per Equation 2,

$$R_{SC} < \frac{V_{SENSE}}{I_{PEAK}} \quad (EQ. 2)$$

where Vsense is 200mV typical (see datasheet specification table) and I_{PEAK} is calculated from Equation 1. Make sure the R_{SC} value is always lower than the V_{SENSE}/I_{PEAK} ratio.

For the typical application conditions (V_{CC} = 12V, I_{OUT} (max) = 450mA) a 100mΩ R_{SC} value is a good choice.

If V_{IN} < 10.5V the inductor peak current can be close to 2A, then, it is necessary to decrease the R_{SC} value.

See Table 4 for some suggested SMD resistor part numbers.

TABLE 4.

VENDOR	SERIES
Meggitt	RL73
SEI Electronics	RMC1
Panasonic	ERJ

Layout Guidelines

Just like all switching power supplies, a proper PC board layout is very important for a single channel ISL6421/ISL6425 based power supply implementation. Protect sensitive analog grounds by using a star ground configuration. Also, minimize lead lengths to reduce stray capacitance, trace resistance, and radiated noise. Minimize ground noise by connecting PGND, the input bypass capacitor ground lead, and the output filter capacitor ground lead to a single point. Place bypass capacitors as close as possible to the BYP pin and PGND and the DC/DC output capacitor as close as possible to VSW.

Place the TCAP capacitor very close to the IC pins and use the shortest possible ground return path.

Thermal Design

During normal operation, the ISL6421/ISL6425 dissipates some power. The power dissipation of the output linear regulator dominates the total power dissipated in the

ISL6421/ISL6425. At the maximum rated output current, the voltage drop on the linear regulator leads to a total dissipated power that is about $1.2V \cdot 750mA = 0.9W$. At 350mA maximum current, this power will be $1.2V \cdot 350mA = 0.42W$. The heat needs to be removed with a heatsink to keep the junction temperature below the over-temperature threshold.

The simplest solution is to use a large, continuous copper area of the ground layer to dissipate the heat. This area can be the inner ground of multi-layered pcbs, or in a dual layer pcb, an unbroken ground area on the opposite side of the board where the IC is placed. In both cases, the thermal path between the IC ground pins and the dissipating copper area must exhibit a low thermal resistance.

Conclusion

The ISL6421/ISL6425 voltage regulator makes an ideal choice for advanced satellite set-top box and personal video recorder applications. The ISL6421EVAL1A/ISL6425EVAL2 is a complete reference design for providing power and control functions to the LNB in advanced satellite set-top box applications.

References

Intersil documents are available on the web at <http://www.intersil.com>.

- [1] *ISL6421 Datasheet*, Intersil Corporation, File No. FN9031
- [2] *ISL6425 Datasheet*, Intersil Corporation, File No. FN9176
- [3] *DiSEqC Bus Functional Specification*, EUTELSAT <http://www.eutelsat.com/docs/diseqc>
- [4] More information on the USB-I2CIO PC to I²C interface board available at <http://www.DeVaSys.com>

ISL6421EVAL1A Schematic

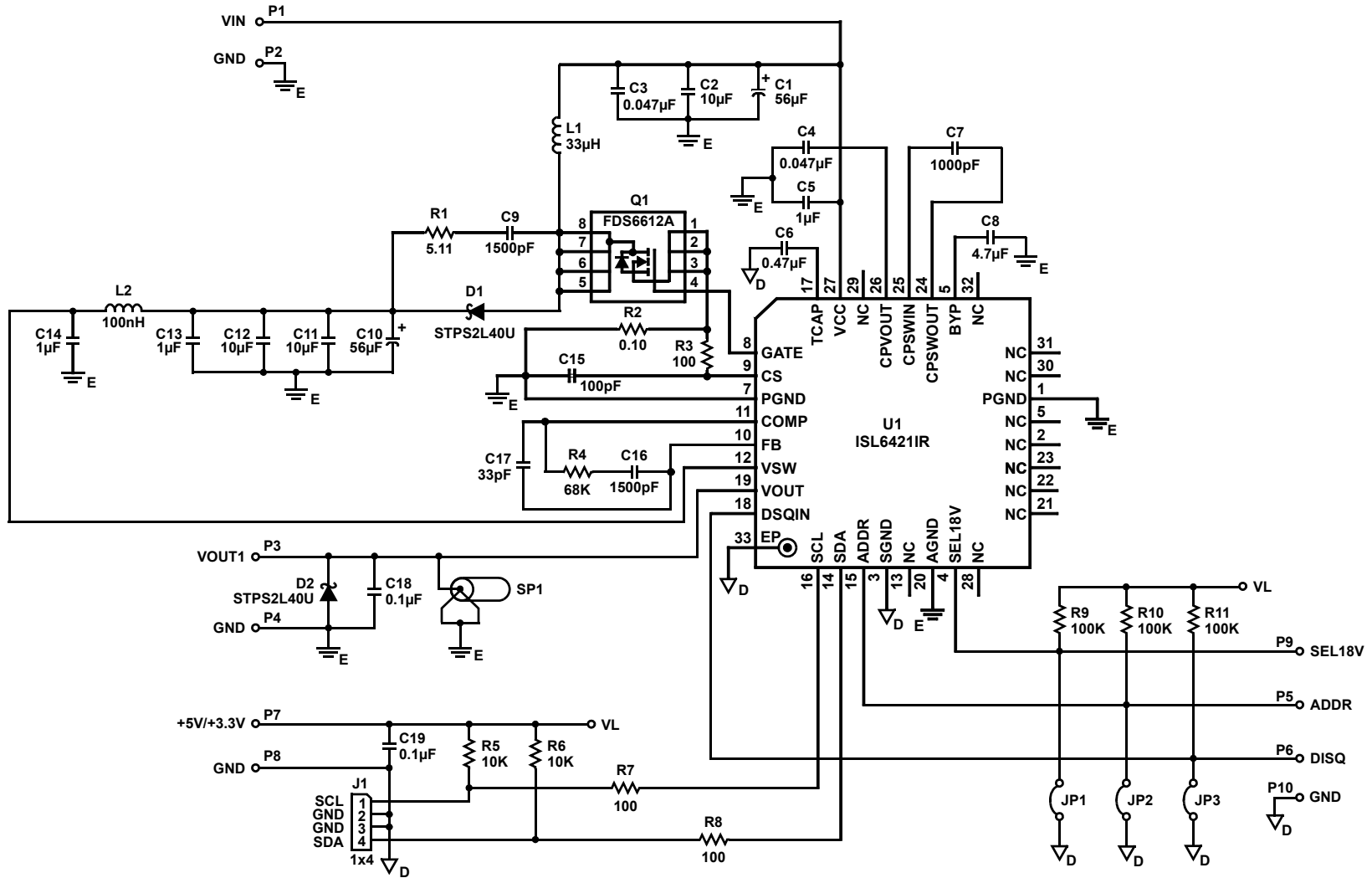

Application Note 1083

ISL6421EVAL1A Bill of Materials

ITEM	REFERENCE	QTY	PART NUMBER	PART TYPE	DESCRIPTION	PACKAGE	VENDOR
1	U1	1	ISL6421IR	IC, Linear	Current mode PWM Controller	32 Ld QFN (5x5)	Intersil
2	Q1	1	FDS6612A	MOSFET Single	N-channel, 30V, 0.022 Ω , 8.4A	SOIC8	Fairchild
3	D1, D2	2	STPS2L40U	Diode, Schottky, Low Drop Power	Schottky, 30V, 2A	DO-214AA	STMicroelectronics
4	L1	2	DS3316P-333	Inductor	33 μ H, 20%, 0.334 Ω , 1.4A	DO3316	CoilCraft
5	L2	2	DN1050CT-ND	Inductor	100nH, 10%, 1175mW	SM_1210	API/Digikey
CAPACITORS							
6	C1, C10	2	25SP56M	Capacitor, Aluminum	56 μ F, 20%, 25V	Radial	SANYO
7	C2, C11, C12	3	TMK325BJ106M	Capacitor, Ceramic, X5R	10 μ F, 20%, 25V	SM_1210	Taiyo-Yuden/Generic
8	C3, C4	2	06033C473KAT2A	Capacitor, Ceramic, X7R	0.047 μ F, 10%, 25V	SM_0603	AVX/Generic
9	C5, C13, C14	3	12063C105KAT2A	Capacitor, Ceramic, X7R	1 μ F, 10%, 25V	SM_1206	AVX/Generic
10	C6	1	1210YC474KAT2A	Capacitor, Ceramic, X7R	0.47 μ F, 10%, 16V	SM_1210	AVX/Generic
11	C7	1	0603YC102KAT2A	Capacitor, Ceramic, X7R	1000pF, 10%, 16V	SM_0603	AVX/Generic
12	C8	1	1210YC475MAT2A	Capacitor, Ceramic, X7R	4.7 μ F, 20%, 16V	SM_1210	AVX/Generic
13	C9	1	08055C152KAT2A	Capacitor, Ceramic, X7R	1500pF, 10%, 50V	SM_0805	AVX/Generic
14	C15	1	06035A101KAT2A	Capacitor, Ceramic, NPO	100pF, 10%, 50V	SM_0603	AVX/Generic
15	C16	1	0603YC152KAT2A	Capacitor, Ceramic, X7R	1500pF, 10%, 16V	SM_0603	AVX/Generic
16	C17	1	ECJ-1VC1H330J	Capacitor, Ceramic, NPO	33pF, 5%, 50V	SM_0603	Panasonic/Generic
17	C18, C19	2	08053C104KAT2A	Capacitor, Ceramic, X7R	0.1 μ F, 10%, 25V	SM_0805	AVX/Generic
RESISTORS							
18	R1	1	9C08052A5R11FKHFT	Resistor, Film	5.11 Ω , 1%, 0.1W	SM_0805	Yageo America/Generic
19	R2	1	ERJ-L1WKF10CU	Resistor, Power metal strip	0.1 Ω , 1%, 1W	SM_2512	Panasonic/Generic
20	R3, R7, R8	3	ERJ-6ENF1000	Resistor, Film	100 Ω , 1%, 0.1W	SM_0603	Panasonic/Generic
21	R4	1		Resistor, Film	68k Ω , 1%, 0.1W	SM_0603	Panasonic/Generic
22	R5, R6	2		Resistor, Film	10k Ω , 5%, 0.1W	SM_0603	Panasonic/Generic
23	R9, R10, R11	3		Resistor, Film	100k Ω , 5%, 0.1W	SM_0603	Panasonic/Generic
OTHERS							
24	J1	1	22-03-2041	Connector	Header Strip, 1x4	1x4 @ 0.1"	Molex
25	JP1, JP2, JP3	3	68000-236-1x2	Header	1x2 Break Strip GOLD		
26	JP1, JP2, JP3	3	S9001-ND	Jumper	2 pin jumper		Digikey
27	SP1	1	129 0701 202	Terminal, Scope Probe	Terminal, Scope Probe		Johnson
28	P1 - P10	10	1514-2	Turrett Post	Terminal post,through hole,1/4 inch tall	PTH	Keystone
29		4		Bumpers			

ISL6421EVAL1A Layout

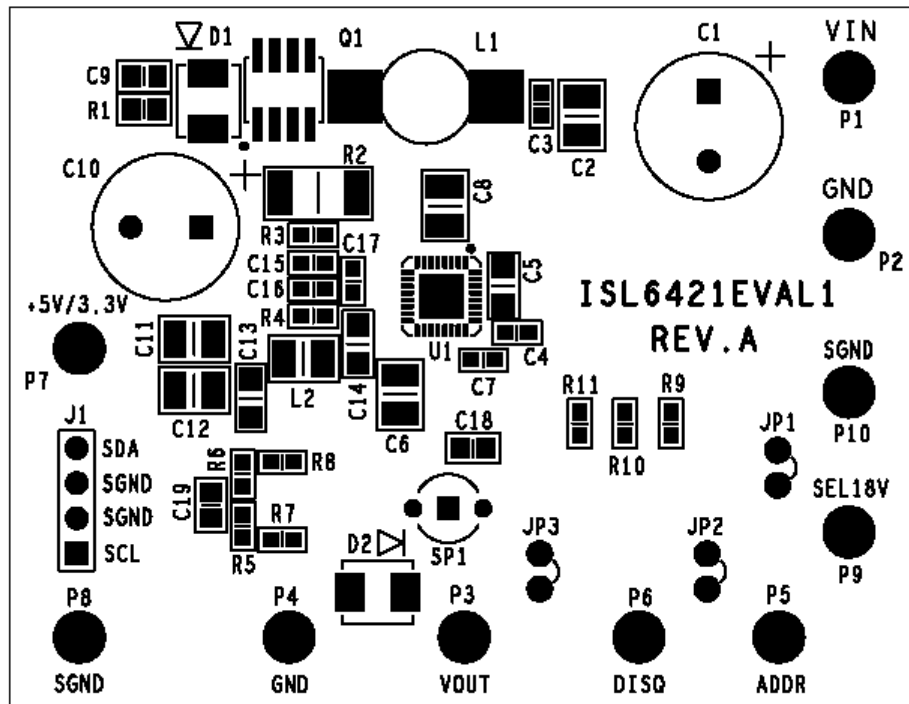

FIGURE 16. TOP SILKSCREEN

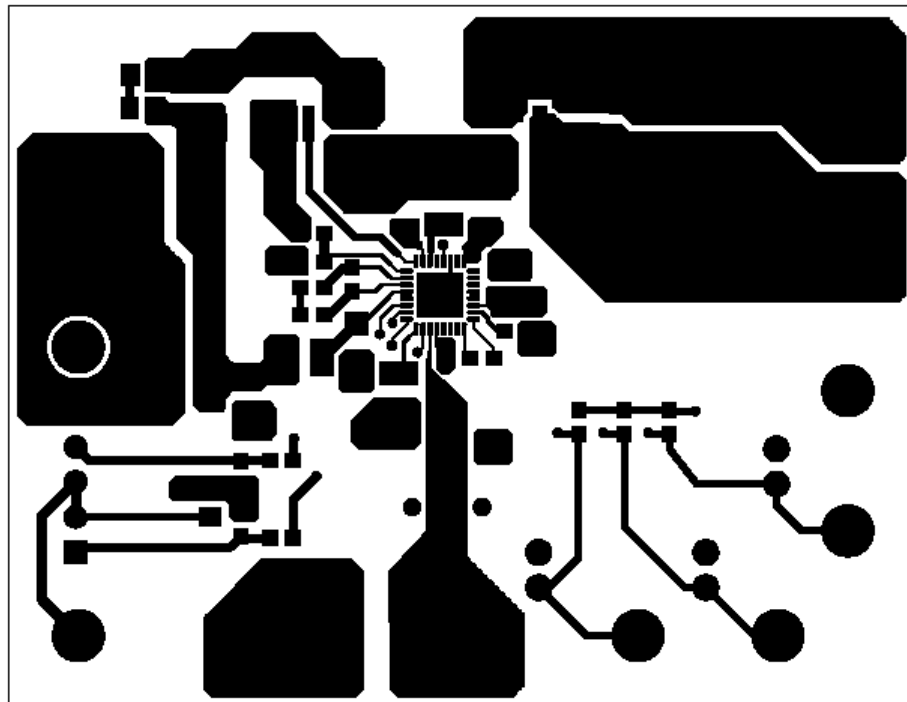

FIGURE 17. LAYER 1

ISL6421EVAL1A Layout (Continued)

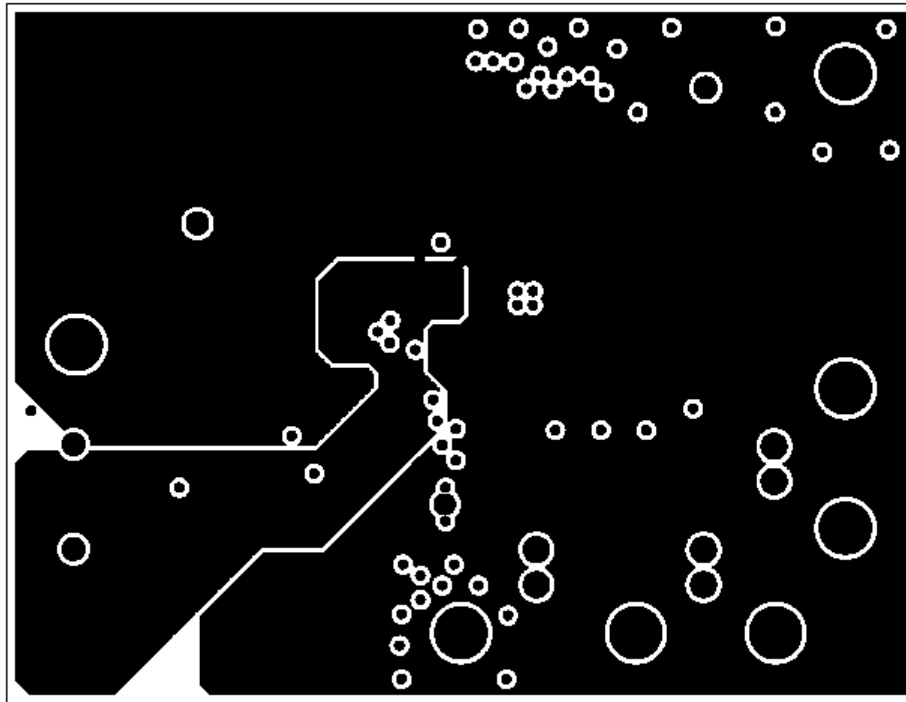

FIGURE 18. LAYER 2

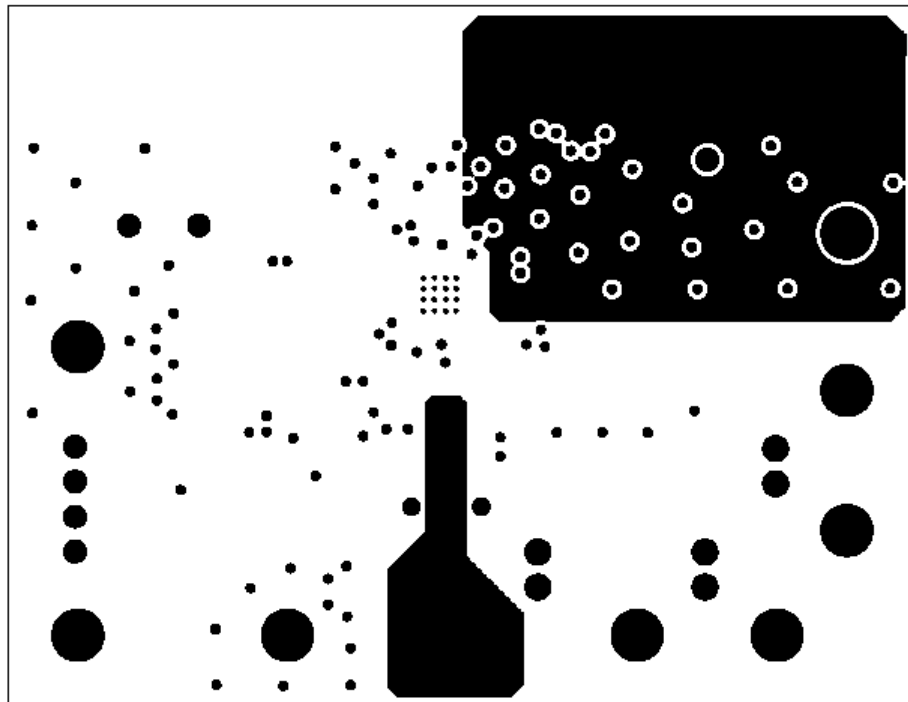

FIGURE 19. LAYER 3

ISL6421EVAL1A Layout (Continued)

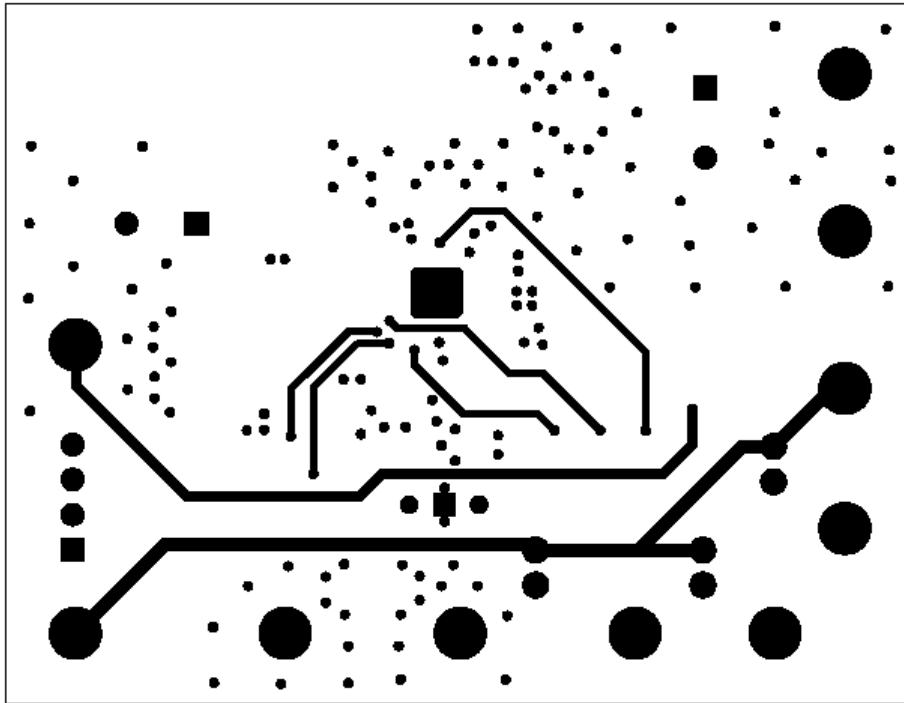

FIGURE 20. LAYER 4

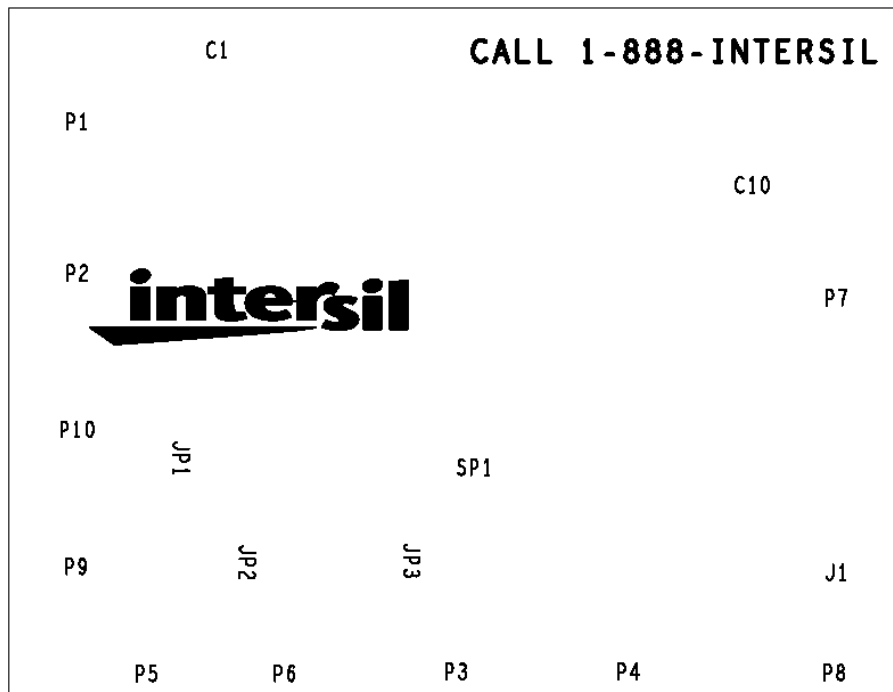

FIGURE 21. BOTTOM SILKSCREEN

Application Note 1083

Bill of Materials ISL6425EVAL2 REV.A

ITEM	REFERENCE	QTY	PART NUMBER	PART TYPE	DESCRIPTION	PACKAGE	VENDOR
1	U1	1	ISL6425ER	IC, Linear	Current mode PWM Controller	32 Ld QFN 5x5	Intersil
2	Q1	1	FDS6612A	MOSFET Single	N-channel, 30V, 0.022Ω, 8.4A	SOIC8	Fairchild
3	D1, D3	2	STPS2L40U	Diode, Schottky, Low Drop Power	Schottky, 30V, 2A	DO-214AA	STMicroelectronics
4	D2, D4 (DNP)	0	BZT52C5V6	Diode, Zener	Zener, 5.6V, 500mW	SOD123	Diodes Inc.
5	D5	1	S1A/B	Diode, Rectifying	Rectifying, 50V	SMB	Diodes Inc.
6	L1	1	MSS-1260-333MX	Inductor	33μH, 20%, 2.2A	MSS1260	CoilCraft
7	L2	1	1008PS-472K	Inductor	4.7μH, 10%, 1.0A	SM	CoilCraft
CAPACITORS							
8	C1, C4	2	25SP56M	Capacitor, Aluminum	56μF, 20%, 25V	CASE-CC	SAYNO
9	C2, C5, C6, C8	8	C3225X7R1E106M	Capacitor, Ceramic, X7R	10μF, 20%, 25V	SM_1210	TDK/Generic
10	C3 (DNP)	1	DNP			SM_0603	TDK/Generic
11	C7, C13, C14	3	C2012X7R1E105K	Capacitor, Ceramic, X7R	1.0μF, 10%, 25V	SM_0805	TDK/Generic
12	C9	1	C1608X7R1H101K	Capacitor, Ceramic, X7R	100pF, 10%, 50V	SM_0603	TDK/Generic
13	C10	1	C1608COG1H330K	Capacitor, Ceramic, COG	33pF, 10%, 50V	SM_0603	TDK/Generic
14	C11	1	C1608X7R1H152K	Capacitor, Ceramic, X7R	1500pF, 10%, 50V	SM_0603	TDK/Generic
15	C12, C15, C19	3	C1608X7R1H104K	Capacitor, Ceramic, X7R	0.1μF, 20%, 50V	SM_0603	TDK/Generic
16	C16	1	C1608X7R1H102K	Capacitor, Ceramic, X7R	1000pF, 10%, 50V	SM_0603	TDK/Generic
17	C17	1	C1608X7R1H473K	Capacitor, Ceramic, X7R	0.047μF, 10%, 50V	SM_0603	TDK/Generic
18	C18	1	C2012X7R1E224K	Capacitor, Ceramic, X7R	0.22μF, 10%, 25V	SM_0603	TDK/Generic
RESISTORS							
19	R1, R6, R13 (DNP)	0	DNP	Resistor, Film		SM_0603	Panasonic/Generic
20	R2	1		Resistor, Power metal strip	0.1Ω, 1%, 1W	SM_2512	Panasonic/Generic
21	R3	1		Resistor, Film	68.1kΩ, 1%, 0.1W	SM_0603	Panasonic/Generic
22	R4	1		Resistor, Film	18.2Ω, 1%, 0.1W	SM_0603	Panasonic/Generic
23	R5, R10	2		Resistor, Film	100kΩ, 5%, 0.1W	SM_0603	Panasonic/Generic
24	R7, R8	2		Resistor, Film	1kΩ, 1%, 0.1W	SM_0603	Panasonic/Generic
25	R9	1		Resistor, Film	470Ω, 1%, 0.1W	SM_0603	Panasonic/Generic
26	R11, R12	2		Resistor, Film	10kΩ, 5%, 0.1W	SM_0603	Panasonic/Generic
OTHERS							
28	J1	1	22-03-2041	Connector	Header Strip, 1X4	1X4@.1"	Molex
29	JP1, JP2, JP3	3	68000-236-1X2	Header	1X2 Break Strip GOLD		
30	JP1, JP2, JP3	3	S9001-ND	Jumper	2 pin jumper		Digikey
31	SP1	1	131-4353-00	Terminal, Scope Probe	Terminal, Scope Probe		Tektronix
32	P1 - P9	9	160-2043-02-01-00	Turret Post	Terminal post, through hole	PTH	Cambion
33		4		Bumpers			

ISL6425EVAL2 Layout

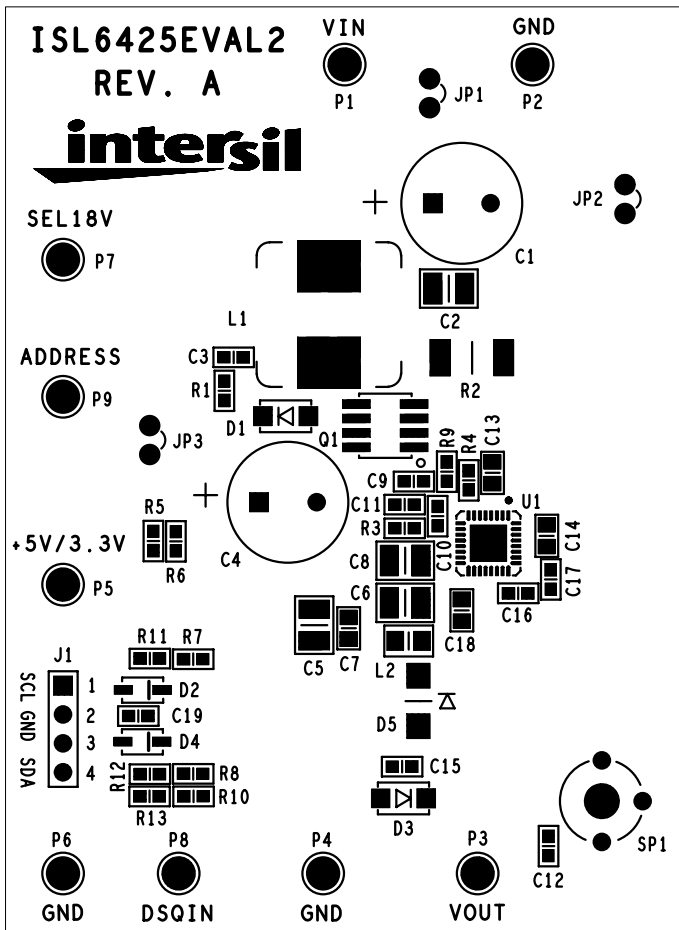

FIGURE 22. TOP SILKSCREEN

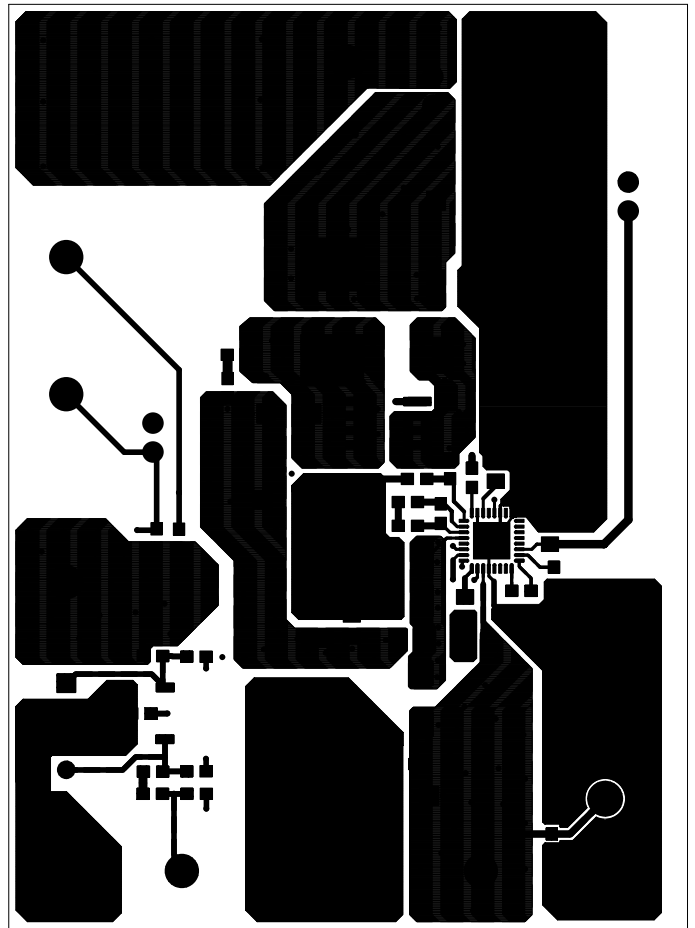

FIGURE 23. TOP LAYER COMPONENT SIDE

ISL6425EVAL2 Layout (Continued)

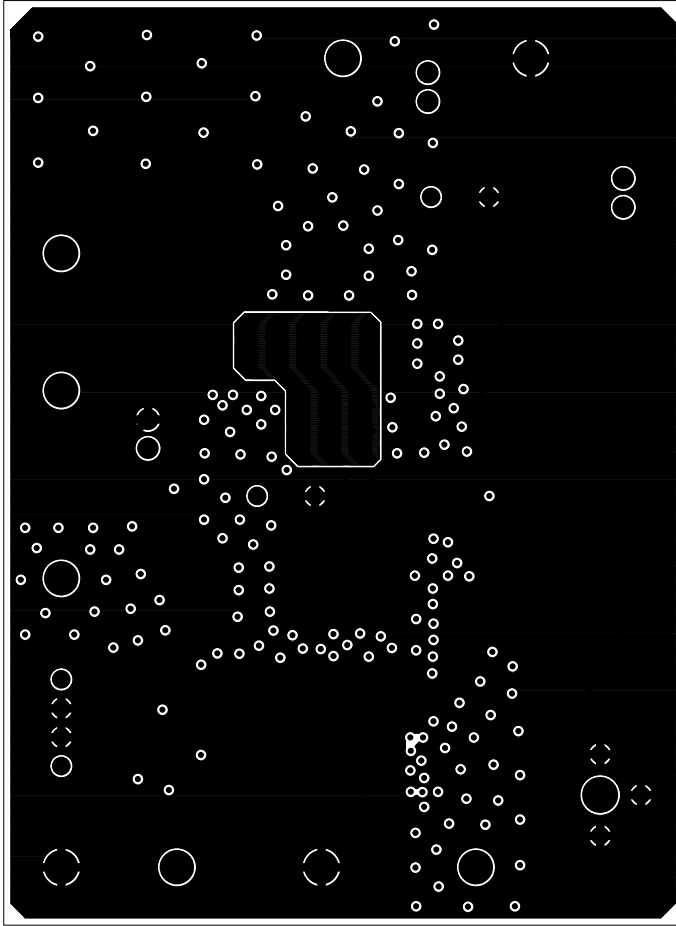

FIGURE 24. LAYER 2

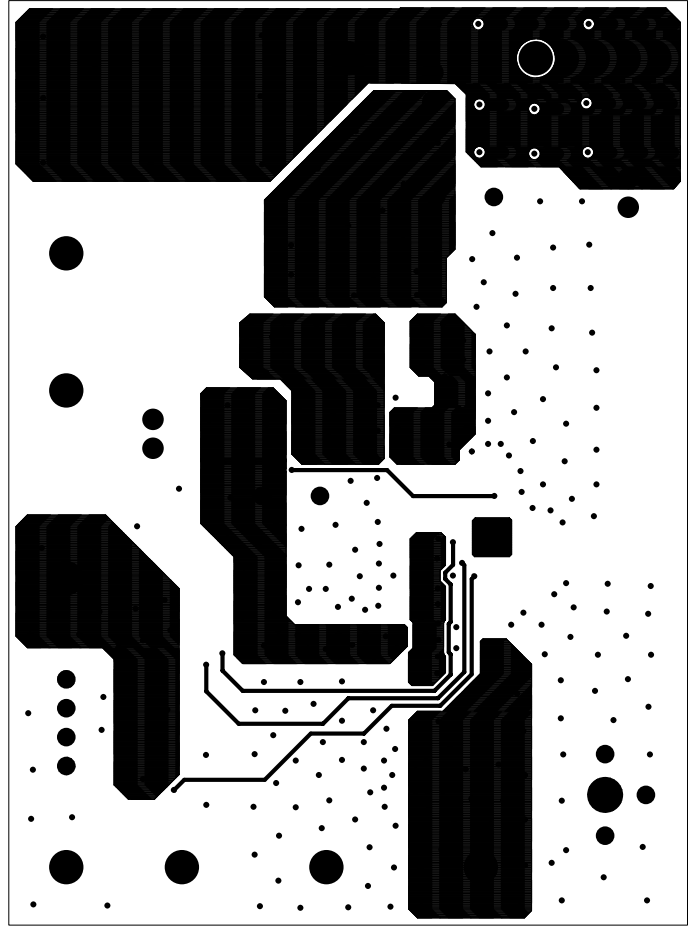

FIGURE 25. LAYER 3

ISL6425EVAL2 Layout (Continued)

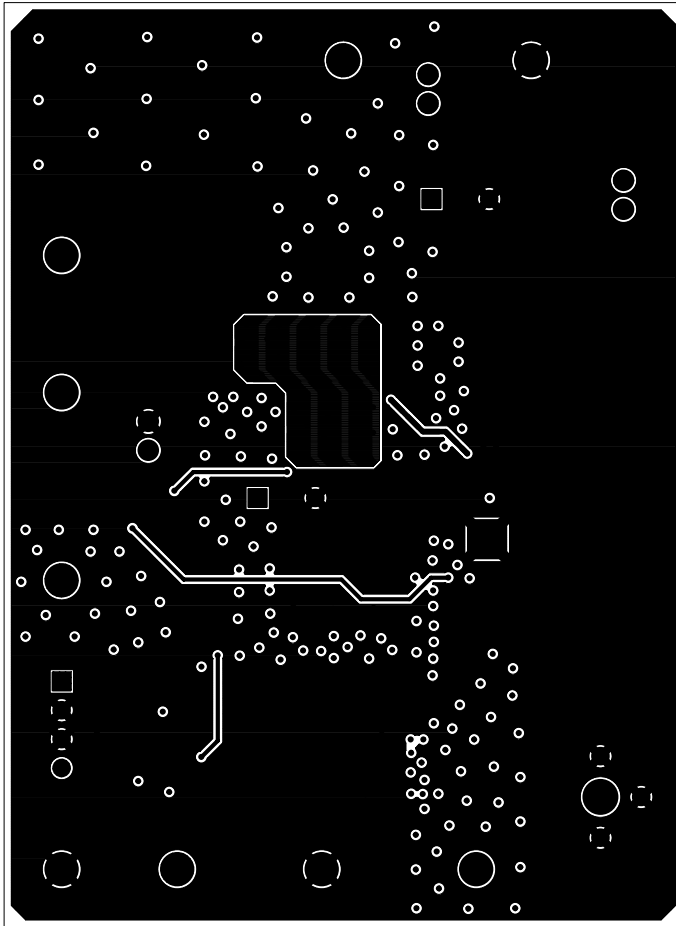

FIGURE 26. BOTTOM LAYER SOLDER SIDE

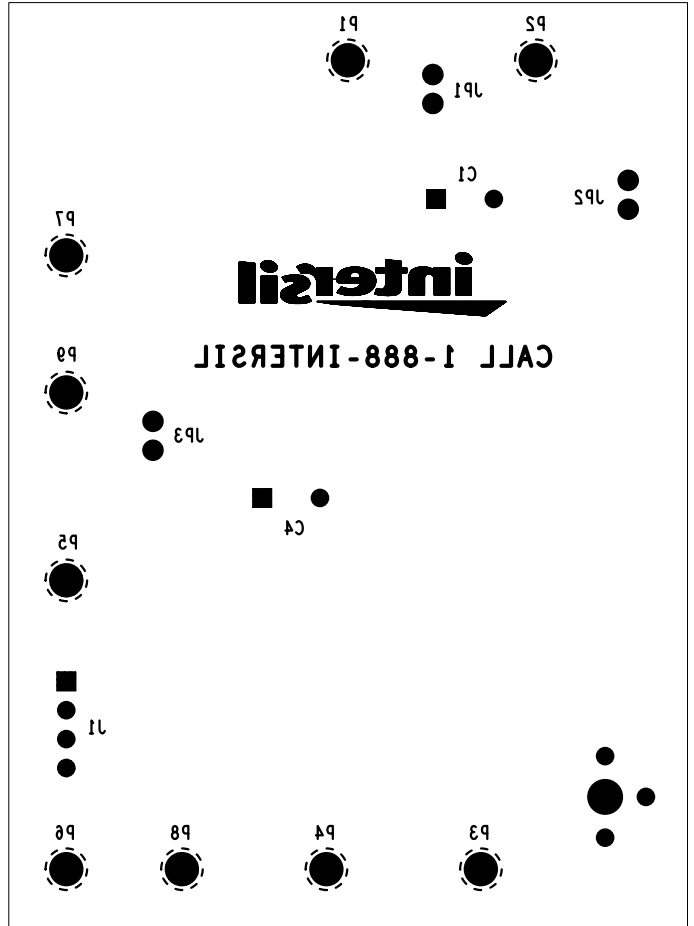

FIGURE 27. BOTTOM SILKSCREEN

Intersil Corporation reserves the right to make changes in circuit design, software and/or specifications at any time without notice. Accordingly, the reader is cautioned to verify that the Application Note or Technical Brief is current before proceeding.

For information regarding Intersil Corporation and its products, see www.intersil.com



Компания «ЭлектроПласт» предлагает заключение долгосрочных отношений при поставках импортных электронных компонентов на взаимовыгодных условиях!

Наши преимущества:

- Оперативные поставки широкого спектра электронных компонентов отечественного и импортного производства напрямую от производителей и с крупнейших мировых складов;
- Поставка более 17-ти миллионов наименований электронных компонентов;
- Поставка сложных, дефицитных, либо снятых с производства позиций;
- Оперативные сроки поставки под заказ (от 5 рабочих дней);
- Экспресс доставка в любую точку России;
- Техническая поддержка проекта, помощь в подборе аналогов, поставка прототипов;
- Система менеджмента качества сертифицирована по Международному стандарту ISO 9001;
- Лицензия ФСБ на осуществление работ с использованием сведений, составляющих государственную тайну;
- Поставка специализированных компонентов (Xilinx, Altera, Analog Devices, Intersil, Interpoint, Microsemi, Aeroflex, Peregrine, Syfer, Eurofarad, Texas Instrument, Miteq, Cobham, E2V, MA-COM, Hittite, Mini-Circuits, General Dynamics и др.);

Помимо этого, одним из направлений компании «ЭлектроПласт» является направление «Источники питания». Мы предлагаем Вам помощь Конструкторского отдела:

- Подбор оптимального решения, техническое обоснование при выборе компонента;
- Подбор аналогов;
- Консультации по применению компонента;
- Поставка образцов и прототипов;
- Техническая поддержка проекта;
- Защита от снятия компонента с производства.



Как с нами связаться

Телефон: 8 (812) 309 58 32 (многоканальный)

Факс: 8 (812) 320-02-42

Электронная почта: org@eplast1.ru

Адрес: 198099, г. Санкт-Петербург, ул. Калинина, дом 2, корпус 4, литера А.