

IRG4BC30SPbF

INSULATED GATE BIPOLAR TRANSISTOR

Standard Speed IGBT

Features

- Standard: optimized for minimum saturation voltage and low operating frequencies (< 1kHz)
- Generation 4 IGBT design provides tighter parameter distribution and higher efficiency than Generation 3
- Industry standard TO-220AB package
- Lead-Free

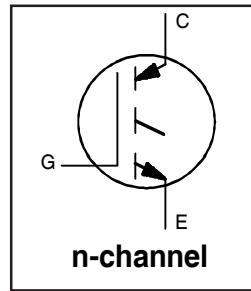

| |
|-----------------------------|
| $V_{CES} = 600V$ |
| $V_{CE(on) typ.} = 1.4V$ |
| @ $V_{GE} = 15V, I_C = 18A$ |

Benefits

- Generation 4 IGBTs offer highest efficiency available
- IGBTs optimized for specified application conditions
- Designed to be a "drop-in" replacement for equivalent industry-standard Generation 3 IR IGBTs

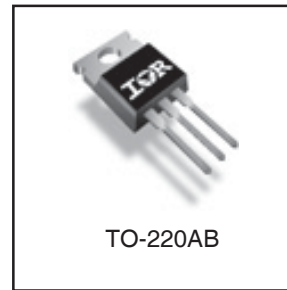

Absolute Maximum Ratings

| | Parameter | Max. | Units |
|---------------------------|--|------------------------------------|-------|
| V_{CES} | Collector-to-Emitter Breakdown Voltage | 600 | V |
| $I_C @ T_C = 25^\circ C$ | Continuous Collector Current | 34 | A |
| $I_C @ T_C = 100^\circ C$ | Continuous Collector Current | 18 | |
| I_{CM} | Pulsed Collector Current ① | 68 | |
| I_{LM} | Clamped Inductive Load Current ② | 68 | |
| V_{GE} | Gate-to-Emitter Voltage | ± 20 | V |
| E_{ARV} | Reverse Voltage Avalanche Energy ③ | 10 | mJ |
| $P_D @ T_C = 25^\circ C$ | Maximum Power Dissipation | 100 | W |
| $P_D @ T_C = 100^\circ C$ | Maximum Power Dissipation | 42 | |
| T_J | Operating Junction and | -55 to + 150 | °C |
| T_{STG} | Storage Temperature Range | | |
| | Soldering Temperature, for 10 seconds | 300 (0.063 in. (1.6mm) from case) | |
| | Mounting torque, 6-32 or M3 screw. | 10 lbf•in (1.1N•m) | |

Thermal Resistance

| | Parameter | Typ. | Max. | Units |
|-----------------|---|------------|------|--------|
| $R_{\theta JC}$ | Junction-to-Case | --- | 1.2 | °C/W |
| $R_{\theta CS}$ | Case-to-Sink, Flat, Greased Surface | 0.50 | --- | |
| $R_{\theta JA}$ | Junction-to-Ambient, typical socket mount | --- | 80 | |
| Wt | Weight | 2.0 (0.07) | --- | g (oz) |

IRG4BC30SPbF

Electrical Characteristics @ $T_J = 25^\circ\text{C}$ (unless otherwise specified)

| | Parameter | Min. | Typ. | Max. | Units | Conditions |
|---------------------------------|--|------|------|-----------|---------|---|
| $V_{(BR)CES}$ | Collector-to-Emitter Breakdown Voltage | 600 | — | — | V | $V_{GE} = 0V, I_C = 250\mu A$ |
| $V_{(BR)ECS}$ | Emitter-to-Collector Breakdown Voltage ④ | 18 | — | — | V | $V_{GE} = 0V, I_C = 1.0A$ |
| $\Delta V_{(BR)CES}/\Delta T_J$ | Temperature Coeff. of Breakdown Voltage | — | 0.75 | — | V/°C | $V_{GE} = 0V, I_C = 1.0mA$ |
| $V_{CE(ON)}$ | Collector-to-Emitter Saturation Voltage | — | 1.40 | 1.6 | V | $I_C = 18A$ $I_C = 34A$ $I_C = 18A, T_J = 150^\circ\text{C}$ $V_{GE} = 15V$ See Fig. 2, 5 |
| | | — | 1.84 | — | | |
| | | — | 1.45 | — | | |
| $V_{GE(th)}$ | Gate Threshold Voltage | 3.0 | — | 6.0 | | $V_{CE} = V_{GE}, I_C = 250\mu A$ |
| $\Delta V_{GE(th)}/\Delta T_J$ | Temperature Coeff. of Threshold Voltage | — | -11 | — | mV/°C | $V_{CE} = V_{GE}, I_C = 250\mu A$ |
| g_{fe} | Forward Transconductance ⑤ | 6.0 | 11 | — | S | $V_{CE} = 100V, I_C = 18A$ |
| I_{CES} | Zero Gate Voltage Collector Current | — | — | 250 | μA | $V_{GE} = 0V, V_{CE} = 600V$ |
| | | — | — | 2.0 | | $V_{GE} = 0V, V_{CE} = 10V, T_J = 25^\circ\text{C}$ |
| | | — | — | 1000 | | $V_{GE} = 0V, V_{CE} = 600V, T_J = 150^\circ\text{C}$ |
| I_{GES} | Gate-to-Emitter Leakage Current | — | — | ± 100 | nA | $V_{GE} = \pm 20V$ |

Switching Characteristics @ $T_J = 25^\circ\text{C}$ (unless otherwise specified)

| | Parameter | Min. | Typ. | Max. | Units | Conditions |
|--------------|-----------------------------------|------|------|------|-------|---|
| Q_g | Total Gate Charge (turn-on) | — | 50 | 75 | nC | $I_C = 18A$ $V_{CC} = 400V$ $V_{GE} = 15V$ See Fig. 8 |
| Q_{ge} | Gate - Emitter Charge (turn-on) | — | 7.3 | 11 | | |
| Q_{gc} | Gate - Collector Charge (turn-on) | — | 17 | 26 | | |
| $t_{d(on)}$ | Turn-On Delay Time | — | 22 | — | ns | $T_J = 25^\circ\text{C}$ $I_C = 18A, V_{CC} = 480V$ $V_{GE} = 15V, R_G = 23\Omega$ Energy losses include "tail" |
| t_r | Rise Time | — | 18 | — | | |
| $t_{d(off)}$ | Turn-Off Delay Time | — | 540 | 810 | | |
| t_f | Fall Time | — | 390 | 590 | mJ | See Fig. 9, 10, 14 |
| E_{on} | Turn-On Switching Loss | — | 0.26 | — | | |
| E_{off} | Turn-Off Switching Loss | — | 3.45 | — | | |
| E_{ts} | Total Switching Loss | — | 3.71 | 5.6 | ns | $T_J = 150^\circ\text{C}$, $I_C = 18A, V_{CC} = 480V$ $V_{GE} = 15V, R_G = 23\Omega$ Energy losses include "tail" |
| $t_{d(on)}$ | Turn-On Delay Time | — | 21 | — | | |
| t_r | Rise Time | — | 19 | — | | |
| $t_{d(off)}$ | Turn-Off Delay Time | — | 790 | — | mJ | See Fig. 11, 14 |
| t_f | Fall Time | — | 760 | — | | |
| E_{ts} | Total Switching Loss | — | 6.55 | — | | |
| L_E | Internal Emitter Inductance | — | 7.5 | — | nH | Measured 5mm from package |
| C_{ies} | Input Capacitance | — | 1100 | — | pF | $V_{GE} = 0V$ $V_{CC} = 30V$ $f = 1.0MHz$ See Fig. 7 |
| C_{oes} | Output Capacitance | — | 72 | — | | |
| C_{res} | Reverse Transfer Capacitance | — | 13 | — | | |

Notes:

- ① Repetitive rating; $V_{GE} = 20V$, pulse width limited by max. junction temperature. (See fig. 13b)
- ② $V_{CC} = 80\%(V_{CES}), V_{GE} = 20V, L = 10\mu H, R_G = 23\Omega$, (See fig. 13a)
- ③ Repetitive rating; pulse width limited by maximum junction temperature.
- ④ Pulse width $\leq 80\mu s$; duty factor $\leq 0.1\%$.
- ⑤ Pulse width $5.0\mu s$, single shot.

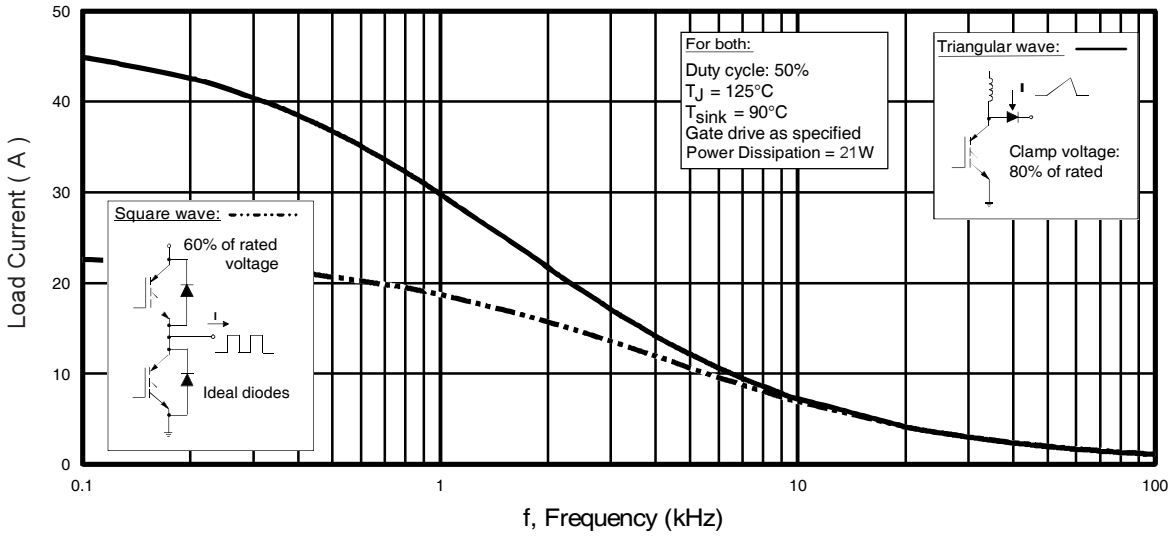

Fig. 1 - Typical Load Current vs. Frequency
(Load Current = I_{RMS} of fundamental)

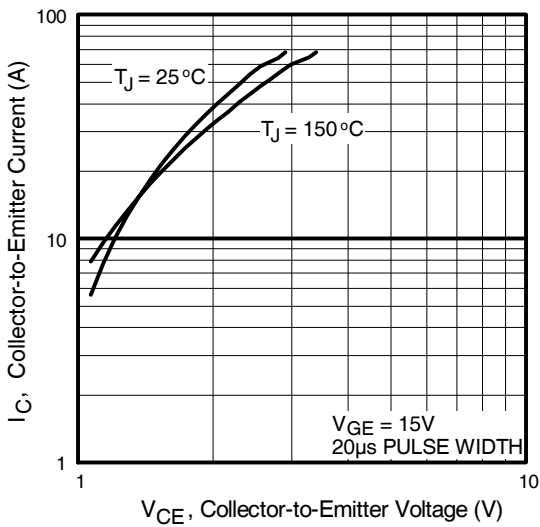

Fig. 2 - Typical Output Characteristics

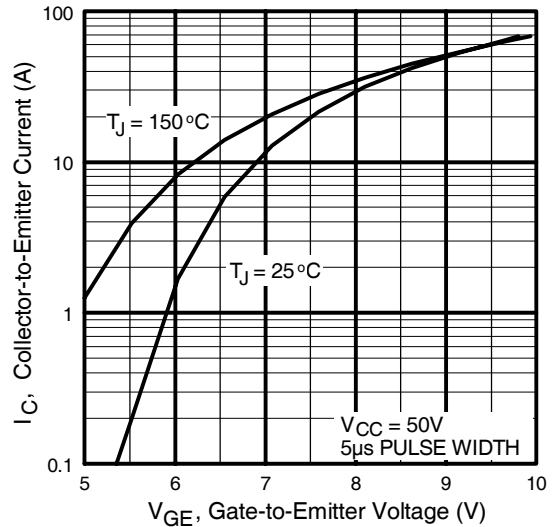

Fig. 3 - Typical Transfer Characteristics

IRG4BC30SPbF

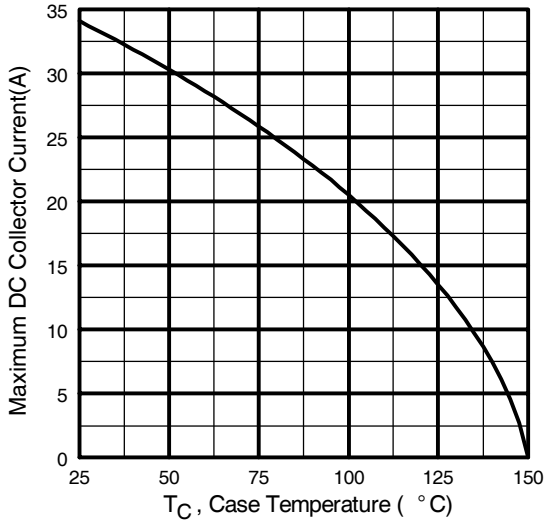

Fig. 4 - Maximum Collector Current vs. Case Temperature

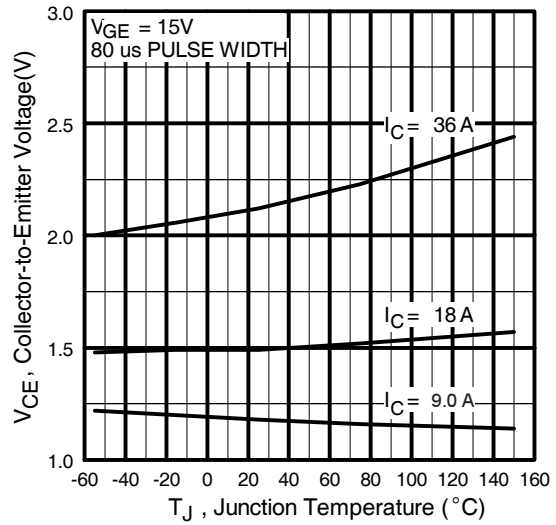

Fig. 5 - Typical Collector-to-Emitter Voltage vs. Junction Temperature

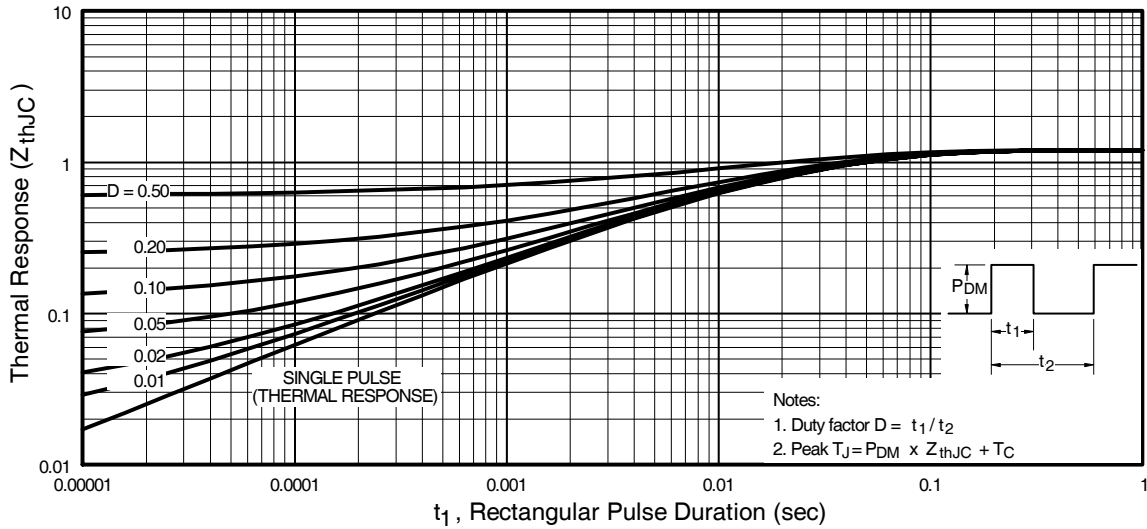

Fig. 6 - Maximum Effective Transient Thermal Impedance, Junction-to-Case

IRG4BC30SPbF

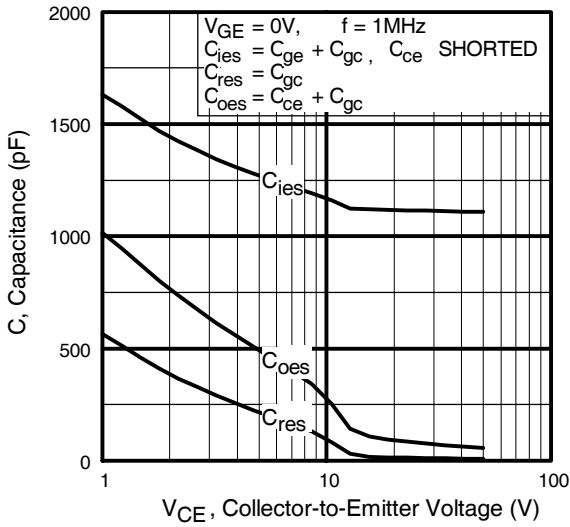

Fig. 7 - Typical Capacitance vs. Collector-to-Emitter Voltage

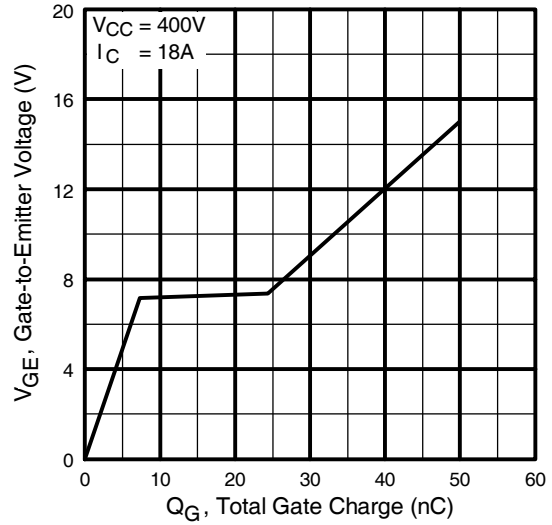

Fig. 8 - Typical Gate Charge vs. Gate-to-Emitter Voltage

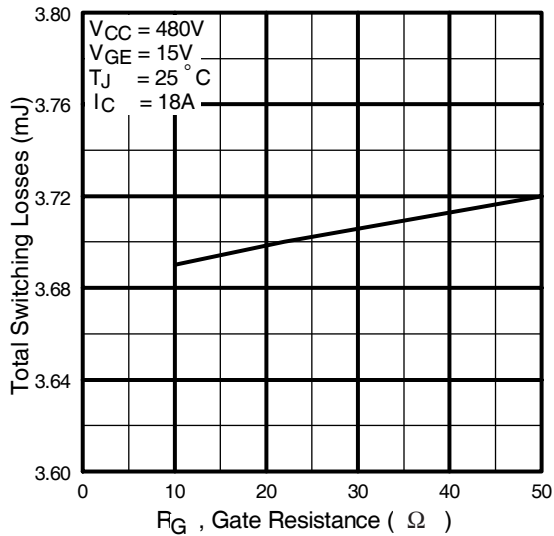

Fig. 9 - Typical Switching Losses vs. Gate Resistance

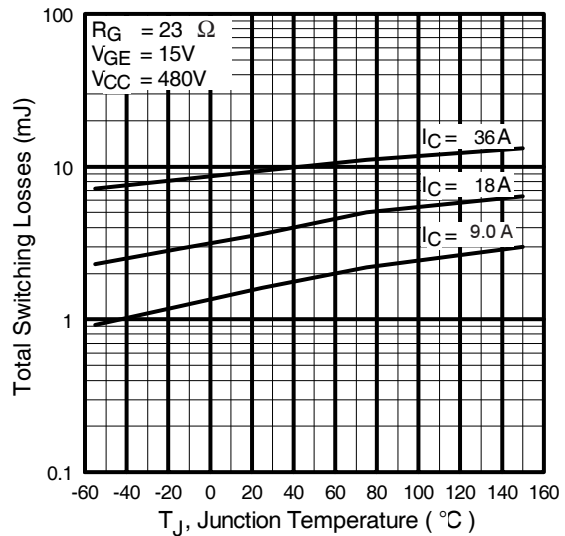

Fig. 10 - Typical Switching Losses vs. Junction Temperature

IRG4BC30SPbF

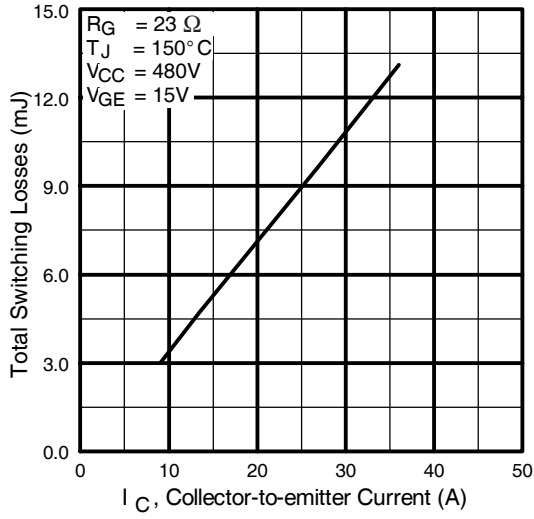

Fig. 11 - Typical Switching Losses vs. Collector-to-Emitter Current

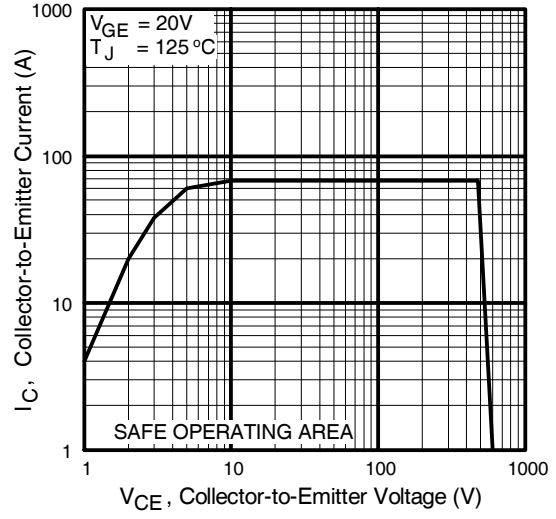
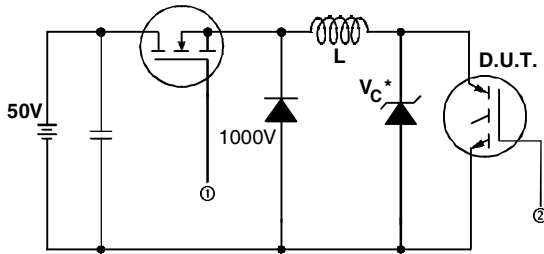

Fig. 12 - Turn-Off SOA

IRG4BC30SPbF



* Driver same type as D.U.T.; $V_c = 80\%$ of $V_{ce(max)}$
 * Note: Due to the 50V power supply, pulse width and inductor will increase to obtain rated I_d .

Fig. 13a - Clamped Inductive Load Test Circuit

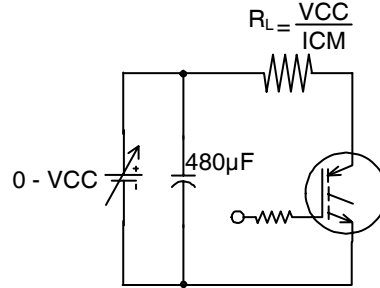

Fig. 13b - Pulsed Collector Current Test Circuit

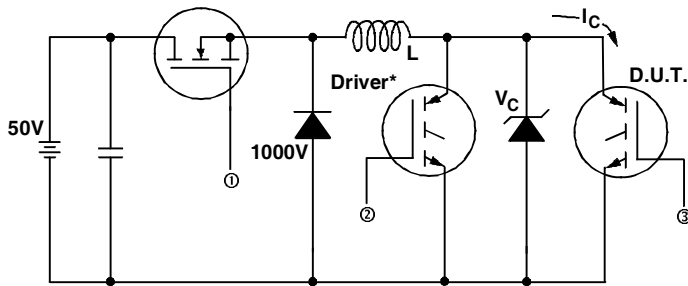

Fig. 14a - Switching Loss Test Circuit

* Driver same type as D.U.T., $V_C = 480V$

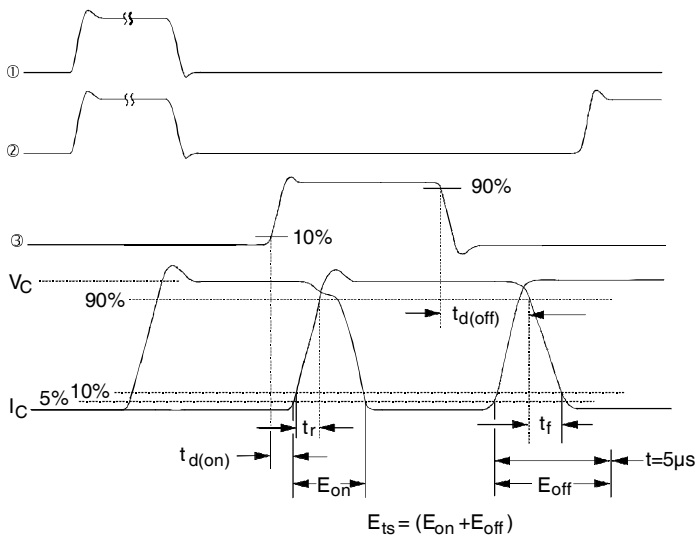
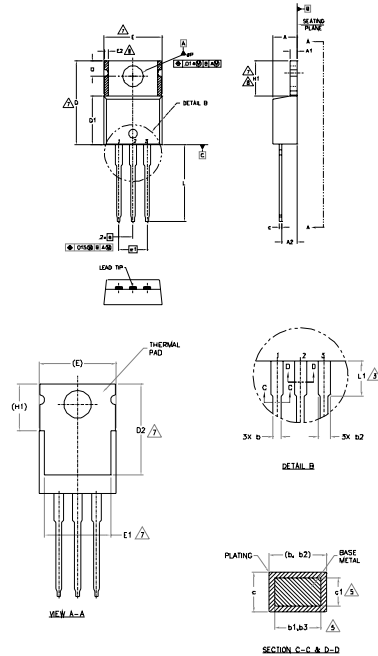

Fig. 14b - Switching Loss Waveforms

IRG4BC30SPbF



TO-220AB Package Outline (Dimensions are shown in millimeters (inches))



- NOTES
- 1.- DIMENSIONS AND TOLERANCING AS PER ASME Y14.5 M-1994.
 - 2.- DIMENSIONS ARE SHOWN IN INCHES (MILLIMETERS).
 - 3.- LEAD DIMENSION AND FINISH UNCONTROLLED IN L1.
 - 4.- DIMENSION D, D1 & E DO NOT INCLUDE MOLD FLASH. MOLD FLASH SHALL NOT EXCEED .002" (0.027) PER SIDE. THESE DIMENSIONS ARE MEASURED AT THE FURTHEST EXTREMES OF THE PLASTIC BODY.
 - 5.- DIMENSION b1, b3 & c1 APPLY TO BASE METAL ONLY.
 - 6.- CONTROLLING DIMENSION - INCHES.
 - 7.- THERMAL PAD CONTOUR OPTIONAL. *TYPICAL DIMENSIONS E1, D2 & E1.
 - 8.- DIMENSION E2 x H1 DEFINE A ZONE WHERE STAMPING AND SINGULATION IRREGULARITIES ARE ALLOWED.
 - 9.- OUTLINE CONFORMS TO JEDEC TO-220 EXCEPT A2 (MAX.) AND D2 (MIN.) WHERE DIMENSIONS ARE DERIVED FROM THE ACTUAL PACKAGE OUTLINE.

| SYMBOL | DIMENSIONS | | DIMENSIONS | | NOTES |
|--------|-------------|-------------|------------|--------|-------|
| | MILLIMETERS | MILLIMETERS | INCHES | INCHES | |
| A | 3.56 | 4.83 | .140 | .190 | |
| A1 | 0.51 | 1.40 | .020 | .055 | |
| A2 | 2.03 | 2.92 | .080 | .115 | |
| b | 0.38 | 1.01 | .015 | .040 | 5 |
| b1 | 0.38 | 0.97 | .015 | .038 | |
| b2 | 1.14 | 1.78 | .045 | .070 | |
| b3 | 1.14 | 1.73 | .045 | .068 | 5 |
| c | 0.36 | 0.61 | .014 | .024 | |
| c1 | 0.36 | 0.56 | .014 | .022 | 5 |
| D | 14.22 | 16.51 | .560 | .650 | 4 |
| D1 | 8.38 | 9.02 | .330 | .355 | |
| D2 | 11.68 | 12.88 | .460 | .507 | 7 |
| E | 6.65 | 10.67 | .260 | .420 | 4,7 |
| E1 | 6.86 | 8.89 | .270 | .350 | 7 |
| E2 | - | 0.76 | - | .030 | 8 |
| e | 2.54 BSC | | .100 BSC | | |
| e1 | 4.06 BSC | | .160 BSC | | |
| H1 | 5.84 | 6.86 | .230 | .270 | 7,8 |
| L | 12.70 | 14.73 | .500 | .580 | |
| L1 | 3.56 | 4.06 | .140 | .160 | 3 |
| W | 3.54 | 4.08 | .139 | .161 | |
| Q | 2.54 | 3.42 | .100 | .135 | |

- LEAD ASSIGNMENTS
- 1- GATE
 - 2- DRN
 - 3- SOURCE
- WELD CONTACTS
- 1- GATE
 - 2- COLLECTOR
 - 3- EMITTER
- DIODES
- 1- ANODE
 - 2- CATHODE
 - 3- ANODE

TO-220AB Part Marking Information

EXAMPLE: THIS IS AN IRF1010
 LOT CODE 1789
 ASSEMBLED ON WW 19, 1997
 IN THE ASSEMBLY LINE 'C'
Note: "P" in assembly line position indicates "Lead-Free"

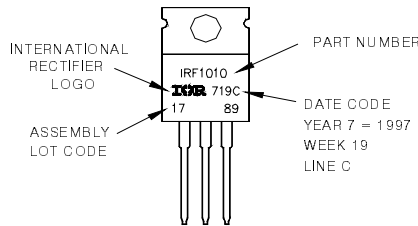

Note: For the most current drawing please refer to IR website at <http://www.irf.com/package/>

Data and specifications subject to change without notice.



IR WORLD HEADQUARTERS: 233 Kansas St., El Segundo, California 90245, USA Tel: (310) 252-7105
 TAC Fax: (310) 252-7903
 Visit us at www.irf.com for sales contact information. 01/2010



Компания «ЭлектроПласт» предлагает заключение долгосрочных отношений при поставках импортных электронных компонентов на взаимовыгодных условиях!

Наши преимущества:

- Оперативные поставки широкого спектра электронных компонентов отечественного и импортного производства напрямую от производителей и с крупнейших мировых складов;
- Поставка более 17-ти миллионов наименований электронных компонентов;
- Поставка сложных, дефицитных, либо снятых с производства позиций;
- Оперативные сроки поставки под заказ (от 5 рабочих дней);
- Экспресс доставка в любую точку России;
- Техническая поддержка проекта, помощь в подборе аналогов, поставка прототипов;
- Система менеджмента качества сертифицирована по Международному стандарту ISO 9001;
- Лицензия ФСБ на осуществление работ с использованием сведений, составляющих государственную тайну;
- Поставка специализированных компонентов (Xilinx, Altera, Analog Devices, Intersil, Interpoint, Microsemi, Aeroflex, Peregrine, Syfer, Eurofarad, Texas Instrument, Miteq, Cobham, E2V, MA-COM, Hittite, Mini-Circuits, General Dynamics и др.);

Помимо этого, одним из направлений компании «ЭлектроПласт» является направление «Источники питания». Мы предлагаем Вам помощь Конструкторского отдела:

- Подбор оптимального решения, техническое обоснование при выборе компонента;
- Подбор аналогов;
- Консультации по применению компонента;
- Поставка образцов и прототипов;
- Техническая поддержка проекта;
- Защита от снятия компонента с производства.



Как с нами связаться

Телефон: 8 (812) 309 58 32 (многоканальный)

Факс: 8 (812) 320-02-42

Электронная почта: org@eplast1.ru

Адрес: 198099, г. Санкт-Петербург, ул. Калинина, дом 2, корпус 4, литера А.