

Series 79 Micro-Crimp Section E: Panel Mount Connectors, Crimp Termination



PANEL RECEPTACLES WITH PIN CONTACTS, CRIMP TERMINATION, 790-026P



790-026P connectors are designed for rear-panel mounting and are supplied with conductive panel gaskets. These connectors feature machined aluminum shells, fluorosilicone face seals and wire grommets for environmental protection. Contacts are rear-release snap-in crimp type. Connectors are supplied with crimp contacts packaged separately. Size #23 signal pins accept up to #22 AWG wire. Size #16 contacts accept #16-18 AWG wire. Size #12 contacts accept #12-14 AWG wire. Size 12 and 16 cavities also accept coaxial contacts purchased separately. Attach optional shielding adapters (799-016) for EMI protection.

HOW TO ORDER

Sample Part Number

790-026P

L-6P6

MT

G

Part Number

Shell Size - Insert Arr.

Shell Finish

Hardware Option

790-026P
Rear Panel Mounted
Receptacle with Pin
Contacts

See Table 1 for Available Insert Arrangements

To order a connector without size #16 or #12 power pins, substitute "W" instead of "P" in the insert arrangement.

Example:

36P2 is supplied with 2 power pins.

36W2 is supplied less the power pins.

See Section B for coaxial contacts purchased separately.

M
Electroless Nickel
general purpose applications

MT
Nickel-PTFE
1000 Hour Grey™
maximum corrosion protection and durability (non-reflective grey)

ZNU
Zinc-Nickel with Black Chromate
tactical applications (non-reflective black)

Additional shell finishes are listed on page C-9.

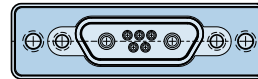

N
No Hardware

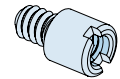

P
Female Jackpost

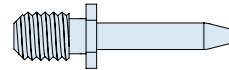

G
Guide Pin

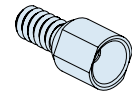

S
Female Guide Socket

SPECIFICATIONS

Current Rating	#23 5 AMPS, #16 13 A., #12 23 A.
Dielectric Withstanding Voltage	#23 500 VAC RMS, #12 and #16 1800 VAC RMS
Insulation Resistance	5000 megohms minimum
Operating Temperature	-65° C. to +150° C.
Shock	300 g.
Vibration	37 g.

MATERIALS AND FINISHES

Shell	Aluminum alloy
Contacts	Copper alloy, 50 microinches gold plated
Insulators	Liquid crystal polymer (LCP)
Retention Clips	Beryllium copper alloy
Interfacial Seal, Grommet	Fluorosilicone rubber
Hardware	300 series stainless steel
Panel Gasket	Fluorosilicone, conductive

Dimensions in inches (millimeters) and are subject to change without notice.

Table 1 Contact Arrangements

Layout	Contact Quantity			Face View
	#23	#16	#12	
A-5	5			
B-2P2	2			
B-9	9			
C-13	13			
D-15	15			
D-3P3	3			
D-7P2	5	2		
E-11P2	9	2		
E-19	19			
E-7P3	4	3		
F-15P2	13	2		
F-23	23			
F-5P5	5			
G-33	33			
H-10P4	6	4		
H-29P7	22	7		
H-36P2	34	2		
H-54P2	52	2		
H-5P5		5		
H-66	66			
J-17P4	13	4		
J-25P2	23	2		
J-33	33			
J-7P7	7			
K-27P4	23	4		
K-35P2	33	2		
K-43	43			
K-9P9	9			
L-6P6		6		

CROSS-SECTIONAL VIEW OF 790-026P

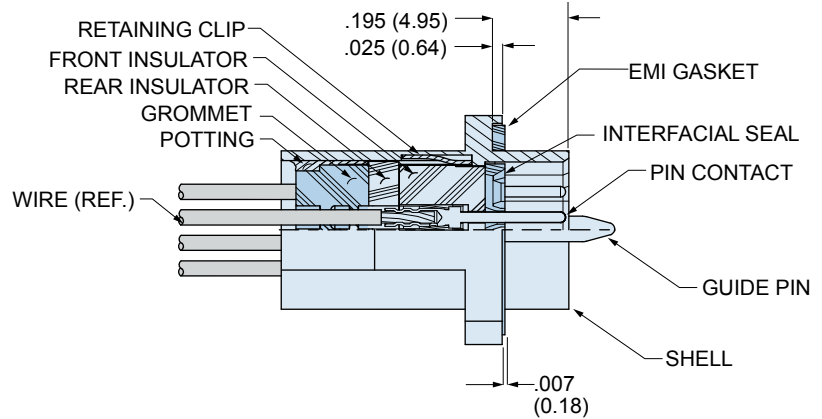
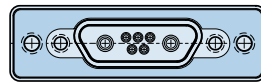
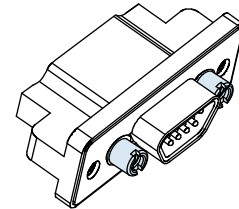

TABLE 2 HARDWARE OPTION



N
No Mating Hardware

Connector is supplied with threaded holes. Shell sizes H and L have #6-32 threads, other sizes have #4-40 threads. Thread depth is .150" (3.8).



P
Jackposts

Connector is supplied with non-removable stainless steel jackposts. Shell sizes H and L have #4-40 UNC thread, other sizes have #2-56 thread. Stainless steel.

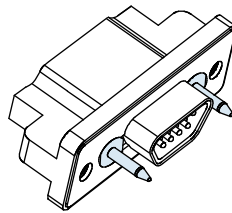

G
Guide Pins

Connector is supplied with stainless steel non-removable guide pins. Mates with type "S" guide sockets on corresponding plug connector.

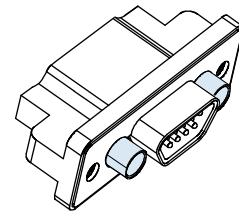

S
Guide Sockets

Connector is supplied with stainless steel non-removable bushings. Mates with type "G" guide pins on corresponding plug connector.

Dimensions in inches (millimeters) and are subject to change without notice.

CAGE Code 06324

Printed in U.S.A.

Series 79 Micro-Crimp Section E: Panel Mount Connectors, Crimp Termination



790-026P SHELL SIZE A,B,C,D,E,F,J,K DIMENSIONS

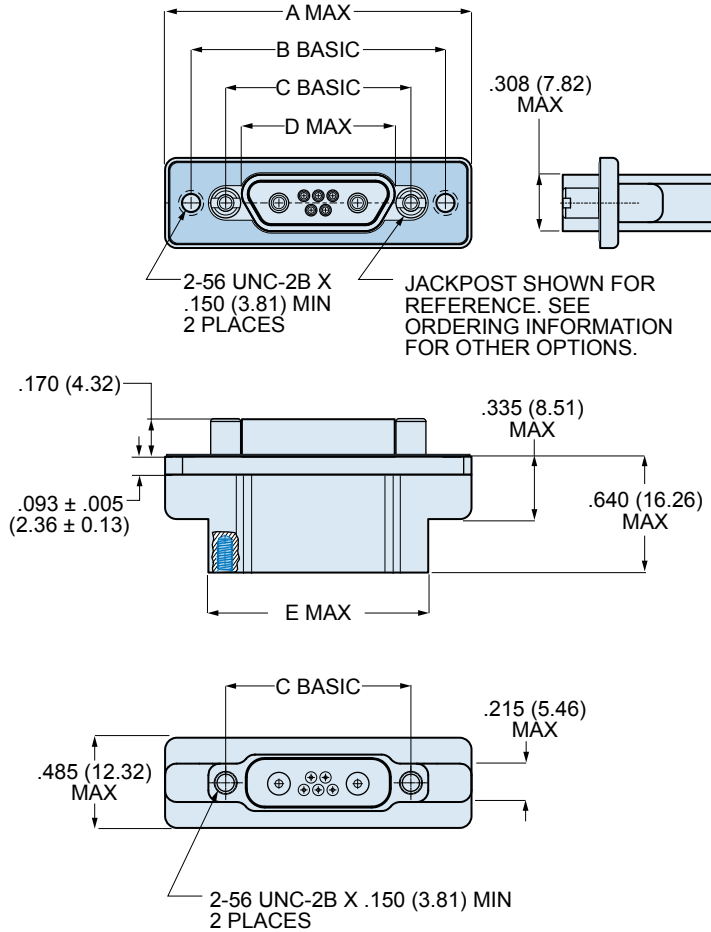

BLIND MATE

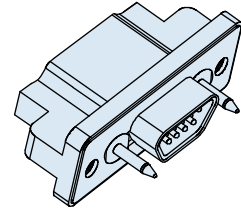

SHELL SIZES A, B, C, D, E, F, G, J, K
+/- .030 (0.76) ALLOWABLE
MISALIGNMENT FROM CENTERLINE

790-026P Dimensions for Size A-F, J and K										
Shell Size	A Max.		B Basic		C Basic		D Max.		E Max.	
	In.	mm.	In.	mm.	In.	mm.	In.	mm.	In.	mm.
A	1.211	30.76	.925	23.50	.565	14.35	.401	10.19	.760	19.30
B	1.361	34.57	1.075	27.31	.715	18.16	.551	14.00	.910	21.11
C	1.511	38.38	1.225	31.12	.865	21.97	.701	17.81	1.060	26.92
D	1.611	40.92	1.325	33.66	.965	24.51	.801	20.35	1.160	29.46
E	1.761	44.73	1.475	37.47	1.115	28.32	.951	24.16	1.310	33.27
F	1.911	48.54	1.625	41.28	1.265	32.13	1.101	27.96	1.460	37.08
J	2.261	57.43	1.975	50.17	1.615	41.02	1.460	37.08	1.810	45.97
K	2.661	67.59	2.375	60.33	2.015	51.18	1.860	47.24	2.210	56.13

Dimensions in inches (millimeters) and are subject to change without notice.

790-026P SHELL SIZE G DIMENSIONS

BLIND MATE

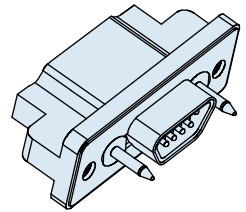
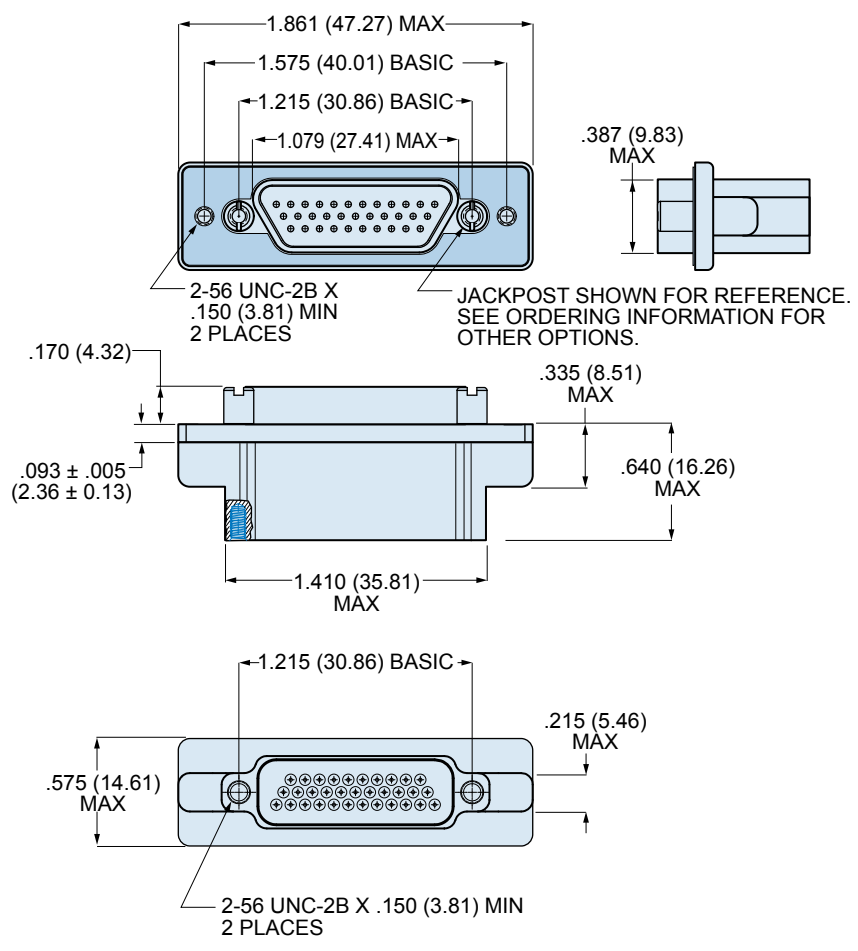

SHELL SIZES A, B, C, D, E, F, G, J, K
+/- .030 (0.76) ALLOWABLE
MISALIGNMENT FROM CENTERLINE

Dimensions in inches (millimeters) and are subject to change without notice.

Series 79 Micro-Crimp Section E: Panel Mount Connectors, Crimp Termination



790-026P SHELL SIZE H AND L DIMENSIONS

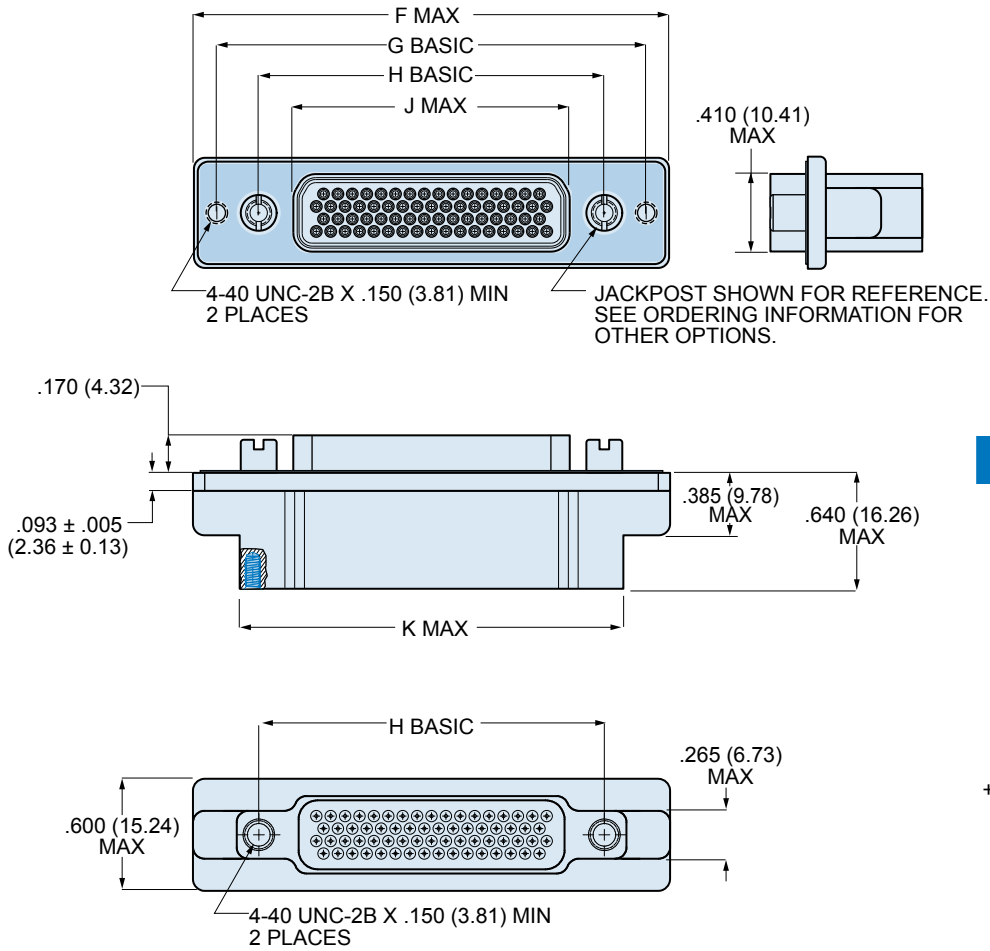

BLIND MATE

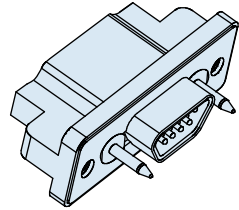

SHELL SIZES H, L
+/- .040 (1.02) ALLOWABLE MISALIGNMENT FROM CENTERLINE

790-026P SIZE H & L DIMENSIONS

Shell Size	F Max.		G Basic		H Basic		J Max.		K Max.	
	In.	mm.	In.	mm.	In.	mm.	In.	mm.	In.	mm.
H	2.500	63.50	2.236	56.79	1.800	45.72	1.450	36.83	2.045	51.94
L	2.736	69.49	2.472	62.79	2.036	51.71	1.686	42.82	2.281	57.94

Dimensions in inches (millimeters) and are subject to change without notice.



Компания «ЭлектроПласт» предлагает заключение долгосрочных отношений при поставках импортных электронных компонентов на взаимовыгодных условиях!

Наши преимущества:

- Оперативные поставки широкого спектра электронных компонентов отечественного и импортного производства напрямую от производителей и с крупнейших мировых складов;
- Поставка более 17-ти миллионов наименований электронных компонентов;
- Поставка сложных, дефицитных, либо снятых с производства позиций;
- Оперативные сроки поставки под заказ (от 5 рабочих дней);
- Экспресс доставка в любую точку России;
- Техническая поддержка проекта, помощь в подборе аналогов, поставка прототипов;
- Система менеджмента качества сертифицирована по Международному стандарту ISO 9001;
- Лицензия ФСБ на осуществление работ с использованием сведений, составляющих государственную тайну;
- Поставка специализированных компонентов (Xilinx, Altera, Analog Devices, Intersil, Interpoint, Microsemi, Aeroflex, Peregrine, Syfer, Eurofarad, Texas Instrument, Miteq, Cobham, E2V, MA-COM, Hittite, Mini-Circuits, General Dynamics и др.);

Помимо этого, одним из направлений компании «ЭлектроПласт» является направление «Источники питания». Мы предлагаем Вам помощь Конструкторского отдела:

- Подбор оптимального решения, техническое обоснование при выборе компонента;
- Подбор аналогов;
- Консультации по применению компонента;
- Поставка образцов и прототипов;
- Техническая поддержка проекта;
- Защита от снятия компонента с производства.



Как с нами связаться

Телефон: 8 (812) 309 58 32 (многоканальный)

Факс: 8 (812) 320-02-42

Электронная почта: org@eplast1.ru

Адрес: 198099, г. Санкт-Петербург, ул. Калинина, дом 2, корпус 4, литера А.