

CDM4-600LR

**SURFACE MOUNT SILICON  
N-CHANNEL  
LR POWER MOSFET  
4.0 AMP, 600 VOLT**



www.centrasemi.com

**ULTRAMOS™**

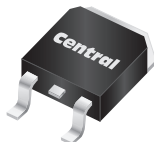

**DPAK CASE**

**DESCRIPTION:**

The CENTRAL SEMICONDUCTOR CDM4-600LR is a 600 Volt N-Channel MOSFET designed for high voltage, fast switching applications such as Power Factor Correction (PFC), lighting and power inverters. This UltraMOS™ MOSFET combines high voltage capability with ultra low  $r_{DS(ON)}$ , low threshold voltage, and low gate charge for optimal efficiency.

**MARKING: FULL PART NUMBER**

**APPLICATIONS:**

- Power Factor Correction
- Alternative energy inverters
- Solid State Lighting (SSL)

**FEATURES:**

- High voltage capability ( $V_{DS}=600V$ )
- Low gate charge ( $Q_{gS}=2.04nC$  TYP)
- Ultra low  $r_{DS(ON)}$  ( $0.65\Omega$  TYP)

**MAXIMUM RATINGS:** ( $T_C=25^\circ C$  unless otherwise noted)

	<b>SYMBOL</b>		<b>UNITS</b>
Drain-Source Voltage	$V_{DS}$	600	V
Gate-Source Voltage	$V_{GS}$	30	V
Continuous Drain Current (Steady State)	$I_D$	4.0	A
Maximum Pulsed Drain Current, $t_p=10\mu s$	$I_{DM}$	13.5	A
Continuous Source Current (Body Diode)	$I_S$	4.0	A
Maximum Pulsed Source Current (Body Diode)	$I_{SM}$	13.5	A
Single Pulse Avalanche Energy (Note 1)	$E_{AS}$	197	mJ
Power Dissipation	$P_D$	38	W
Operating and Storage Junction Temperature	$T_J, T_{stg}$	-55 to +150	$^\circ C$
Thermal Resistance	$\theta_{JC}$	3.29	$^\circ C/W$
Thermal Resistance	$\theta_{JA}$	110	$^\circ C/W$

Note 1:  $L=30mH, I_{AS}=3.5A, V_{DD}=100V, R_G=25\Omega, \text{Initial } T_J=25^\circ C$

**ELECTRICAL CHARACTERISTICS:** ( $T_C=25^\circ C$  unless otherwise noted)

<b>SYMBOL</b>	<b>TEST CONDITIONS</b>	<b>MIN</b>	<b>TYP</b>	<b>MAX</b>	<b>UNITS</b>
$I_{GSSF}, I_{GSSR}$	$V_{GS}=30V, V_{DS}=0$			100	nA
$I_{DSS}$	$V_{DS}=600V, V_{GS}=0$		0.065	1.0	$\mu A$
$BV_{DSS}$	$V_{GS}=0, I_D=250\mu A$	600			V
$V_{GS(th)}$	$V_{GS}=V_{DS}, I_D=250\mu A$	2.0	3.25	4.0	V
$V_{SD}$	$V_{GS}=0, I_S=4.0A$		0.86	1.4	V
$r_{DS(ON)}$	$V_{GS}=10V, I_D=2.0A$		0.65	0.95	$\Omega$
$C_{rSS}$	$V_{DS}=100V, V_{GS}=0, f=1.0MHz$		1.31		pF
$C_{iSS}$	$V_{DS}=100V, V_{GS}=0, f=1.0MHz$		328		pF
$C_{OSS}$	$V_{DS}=100V, V_{GS}=0, f=1.0MHz$		26		pF

R2 (10-August 2015)

**CDM4-600LR**  
**SURFACE MOUNT SILICON**  
**N-CHANNEL**  
**LR POWER MOSFET**  
**4.0 AMP, 600 VOLT**



**ELECTRICAL CHARACTERISTICS - Continued:** ( $T_C=25^\circ\text{C}$  unless otherwise noted)

SYMBOL	TEST CONDITIONS	TYP	UNITS
$Q_{g(\text{tot})}$	$V_{DS}=480\text{V}, V_{GS}=10\text{V}, I_D=4.0\text{A}$ (Note 2)	11.59	nC
$Q_{gs}$	$V_{DS}=480\text{V}, V_{GS}=10\text{V}, I_D=4.0\text{A}$ (Note 2)	2.04	nC
$Q_{gd}$	$V_{DS}=480\text{V}, V_{GS}=10\text{V}, I_D=4.0\text{A}$ (Note 2)	6.09	nC
$t_{d(\text{on})}$	$V_{DD}=300\text{V}, V_{GS}=10\text{V}, I_D=4.0\text{A}, R_G=25\Omega$ (Note 2)	8.0	ns
$t_r$	$V_{DD}=300\text{V}, V_{GS}=10\text{V}, I_D=4.0\text{A}, R_G=25\Omega$ (Note 2)	24	ns
$t_{d(\text{off})}$	$V_{DD}=300\text{V}, V_{GS}=10\text{V}, I_D=4.0\text{A}, R_G=25\Omega$ (Note 2)	33	ns
$t_f$	$V_{DD}=300\text{V}, V_{GS}=10\text{V}, I_D=4.0\text{A}, R_G=25\Omega$ (Note 2)	24	ns
$t_{rr}$	$V_{GS}=0, I_S=4.0\text{A}, di/dt=100\text{A}/\mu\text{s}$ (Note 2)	211	ns
$Q_{rr}$	$V_{GS}=0, I_S=4.0\text{A}, di/dt=100\text{A}/\mu\text{s}$ (Note 2)	1.7	$\mu\text{C}$

Note 2: Pulse Width  $\leq 300\mu\text{s}$ , Duty Cycle  $\leq 2\%$

**DPAK CASE - MECHANICAL OUTLINE**

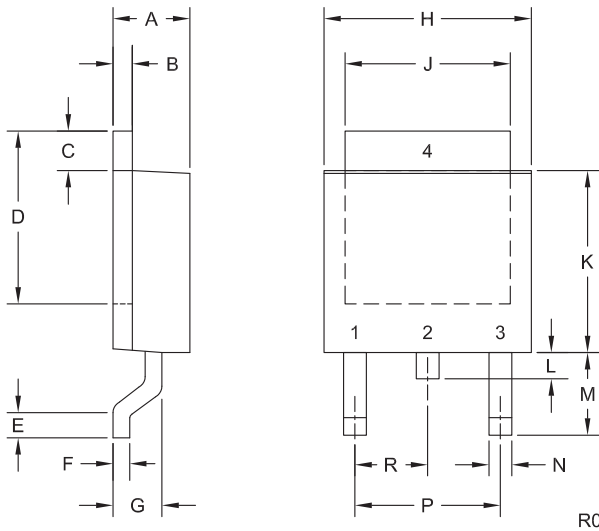

SYMBOL	INCHES		MILLIMETERS	
	MIN	MAX	MIN	MAX
A	0.083	0.108	2.10	2.75
B	0.016	0.032	0.40	0.81
C	0.035	0.063	0.89	1.60
D	0.203	0.228	5.15	5.79
E	0.020	-	0.51	-
F	0.018	0.024	0.45	0.60
G	0.051	0.071	1.30	1.80
H	0.248	0.268	6.30	6.81
J	0.197	0.217	5.00	5.50
K	0.209	0.245	5.30	6.22
L	0.025	0.040	0.64	1.02
M	0.090	0.115	2.30	2.91
N	0.012	0.045	0.30	1.14
P	0.180		4.60	
R	0.090		2.30	

DPAK (REV: R0)

**PIN CONFIGURATION**

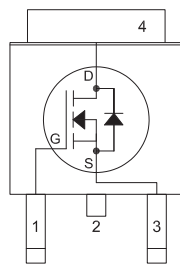

**LEAD CODE:**

- 1) Gate
  - 2) Drain
  - 3) Source
  - 4) Drain
- Pin 2 is common to the tab (4)

**MARKING: FULL PART NUMBER**

R2 (10-August 2015)

CDM4-600LR

SURFACE MOUNT SILICON  
N-CHANNEL  
LR POWER MOSFET  
4.0 AMP, 600 VOLT



TYPICAL ELECTRICAL CHARACTERISTICS

Output Characteristics

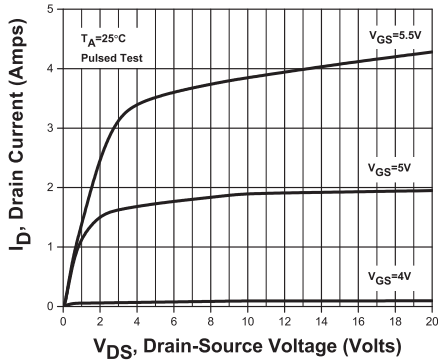

Drain Source On Resistance

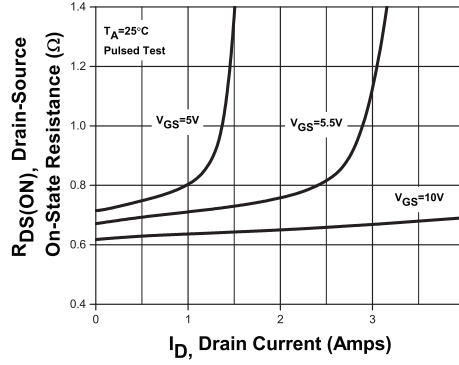

Capacitance

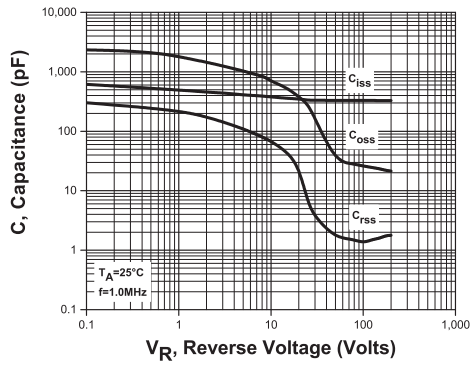

Transfer Characteristics

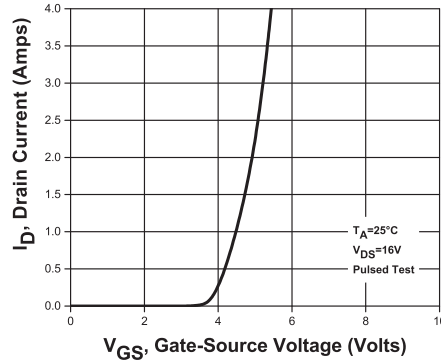

Power Derating

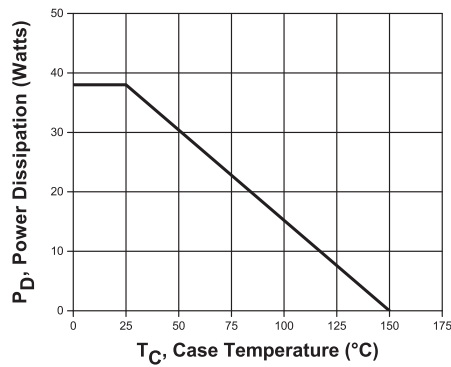

R2 (10-August 2015)

## OUTSTANDING SUPPORT AND SUPERIOR SERVICES



---

### PRODUCT SUPPORT

Central's operations team provides the highest level of support to insure product is delivered on-time.

- Supply management (Customer portals)
- Inventory bonding
- Consolidated shipping options
- Custom bar coding for shipments
- Custom product packing

---

### DESIGNER SUPPORT/SERVICES

Central's applications engineering team is ready to discuss your design challenges. Just ask.

- Free quick ship samples (2<sup>nd</sup> day air)
- Online technical data and parametric search
- SPICE models
- Custom electrical curves
- Environmental regulation compliance
- Customer specific screening
- Up-screening capabilities
- Special wafer diffusions
- PbSn plating options
- Package details
- Application notes
- Application and design sample kits
- Custom product and package development

---

### CONTACT US

#### Corporate Headquarters & Customer Support Team

Central Semiconductor Corp.  
145 Adams Avenue  
Hauppauge, NY 11788 USA  
Main Tel: (631) 435-1110  
Main Fax: (631) 435-1824  
Support Team Fax: (631) 435-3388  
[www.centrasemi.com](http://www.centrasemi.com)

**Worldwide Field Representatives:**  
[www.centrasemi.com/wwreps](http://www.centrasemi.com/wwreps)

**Worldwide Distributors:**  
[www.centrasemi.com/wwdistributors](http://www.centrasemi.com/wwdistributors)

---

For the latest version of Central Semiconductor's **LIMITATIONS AND DAMAGES DISCLAIMER**, which is part of Central's Standard Terms and Conditions of sale, visit: [www.centrasemi.com/terms](http://www.centrasemi.com/terms)



Компания «ЭлектроПласт» предлагает заключение долгосрочных отношений при поставках импортных электронных компонентов на взаимовыгодных условиях!

Наши преимущества:

- Оперативные поставки широкого спектра электронных компонентов отечественного и импортного производства напрямую от производителей и с крупнейших мировых складов;
- Поставка более 17-ти миллионов наименований электронных компонентов;
- Поставка сложных, дефицитных, либо снятых с производства позиций;
- Оперативные сроки поставки под заказ (от 5 рабочих дней);
- Экспресс доставка в любую точку России;
- Техническая поддержка проекта, помощь в подборе аналогов, поставка прототипов;
- Система менеджмента качества сертифицирована по Международному стандарту ISO 9001;
- Лицензия ФСБ на осуществление работ с использованием сведений, составляющих государственную тайну;
- Поставка специализированных компонентов (Xilinx, Altera, Analog Devices, Intersil, Interpoint, Microsemi, Aeroflex, Peregrine, Syfer, Eurofarad, Texas Instrument, Miteq, Cobham, E2V, MA-COM, Hittite, Mini-Circuits, General Dynamics и др.);

Помимо этого, одним из направлений компании «ЭлектроПласт» является направление «Источники питания». Мы предлагаем Вам помощь Конструкторского отдела:

- Подбор оптимального решения, техническое обоснование при выборе компонента;
- Подбор аналогов;
- Консультации по применению компонента;
- Поставка образцов и прототипов;
- Техническая поддержка проекта;
- Защита от снятия компонента с производства.



#### Как с нами связаться

**Телефон:** 8 (812) 309 58 32 (многоканальный)

**Факс:** 8 (812) 320-02-42

**Электронная почта:** [org@eplast1.ru](mailto:org@eplast1.ru)

**Адрес:** 198099, г. Санкт-Петербург, ул. Калинина, дом 2, корпус 4, литера А.