

## *i*Coupler ADuM347x Quad-Channel Isolators with Integrated Transformer Driver Evaluation Board

### FEATURES

2 independent ADuM347x circuits including 2.5 kV<sub>rms</sub> isolated dc-to-dc converters

#### Single supply

5 V in to 5 V out (regulated)

Reconfigurable to 5 V in to 3.3 V out or 3.3 V in to 3.3 V out

#### Double supply

5 V in to 15 V out (regulated) and 7.5 V out (unregulated)

Reconfigurable to 5 V in to 12 V out (regulated) and 6 V out (unregulated)

4 isolated 25 Mbps data channels per ADuM347x circuit

Footprints for Coilcraft and Halo transformer options

Multiple switching frequency options

### GENERAL DESCRIPTION

The EVAL-ADuM3471EBZ demonstrates two separate applications for the ADuM347x family of quad-channel digital isolators with integrated transformer drivers. It has two independent power supply circuits: a double supply and a single supply. The switching frequency can be set from 200 kHz to 1000 kHz. The board supports a variety of I/O configurations and multiple transformer options. It is equipped with two ADuM3471 isolators.

### SUPPORTED *i*Coupler MODELS

[ADuM3470](#)

[ADuM3471](#)

[ADuM3472](#)

[ADuM3473](#)

[ADuM3474](#)

### EVALUATION BOARD

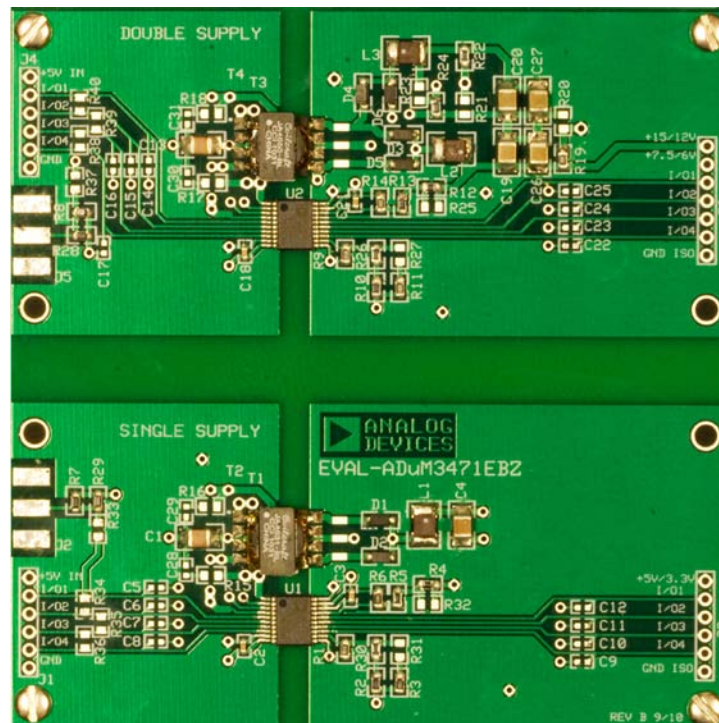

Figure 1. ADuM3471 Evaluation Board

**TABLE OF CONTENTS**

Features .....	1	Schematic.....	6
General Description .....	1	Double Supply.....	7
Supported <i>i</i> Coupler models .....	1	Terminals.....	7
Evaluation Board .....	1	Transformer Selection .....	8
Revision History .....	2	Switching Frequency Options.....	8
Single Supply .....	3	Other Secondary Isolated Supply Configurations .....	10
Terminals.....	3	Schematic.....	10
Transformer Selection.....	4	Evaluation Board Layout .....	11
Switching Frequency Options.....	4	Ordering Information.....	12
Other Input and Isolated Output Supply Options .....	4	Bill of Materials.....	12

**REVISION HISTORY**

10/10—Revision 0: Initial Version

## SINGLE SUPPLY

Two independent and isolated circuits comprise the ADuM3471 evaluation board. The lower half of the board, shown in Figure 2, is a single power supply configuration (see the appropriate ADuM347x data sheet for applications information about the ADuM347x in this configuration).

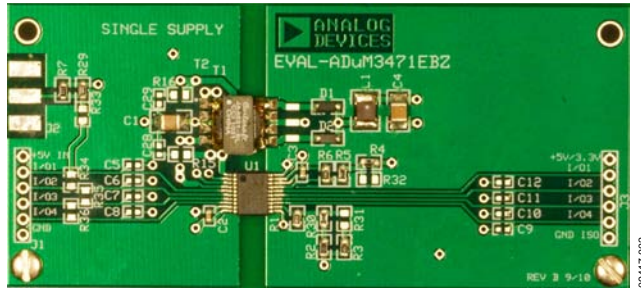

Figure 2. Single Supply

The single supply comes configured as a 5 V secondary isolated supply with a 5 V primary input supply, which can provide up to 2.5 W of regulated, isolated power. It can be reconfigured for a 3.3 V secondary isolated supply with a 5 V or 3.3 V primary input supply (see the Other Input and Isolated Output Supply Options section). Figure 9 shows the single supply schematic.

### TERMINALS

The single supply has terminal blocks on Side 1 (the primary/power supply input side) and Side 2 (the secondary/power supply output side). A 4.3 mm isolation barrier separates Side 1 and Side 2. Figure 3 shows these terminal locations. Although the board is populated with the ADuM3471, it is designed to accommodate the entire ADuM347x family. Therefore, the silkscreen shows I/Ox to denote the four *i*Coupler® data channels.

J1 and J3 are 0.1 inch (2.54 mm) 6x1 headers. J2 has pads for an optional SMA connector (not populated) terminated into 50  $\Omega$ . Table 1 summarizes the functions of the terminal connections. They are described in detail in the Input Power Connections, Output Power Connections, and Data I/O Connection sections.

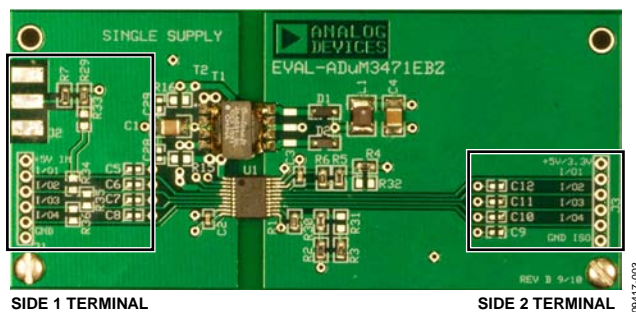

Figure 3. Single Supply Terminals

### Input Power Connections

Connect +5 V to Pin 1 of J1, labeled +5V IN (or +3.3 V for a 3.3 V primary input supply with a 3.3 V secondary isolated supply). Connect the supply negative to Pin 6, labeled GND

(GND1 in the schematic). These are the only off-board connections required for the single supply to function.

+5 V IN supplies  $V_{DD1}$  and  $V_{DDA}$  to U1, the single supply ADuM3471.  $V_{DD1}$  is the ADuM3471 transformer driver supply, and  $V_{DDA}$  is its primary supply voltage (see the ADuM347x data sheet for additional information about these pin functions).  $V_{DD1}/V_{DDA}$  is bypassed by a 47  $\mu$ F ceramic capacitor, labeled C1, and a 0.1  $\mu$ F local bypass capacitor located close to the ADuM3471 (C2). R15, R16, C28, and C29 are provided for an optional and unpopulated snubber, which can be used to reduce radiated emissions.

Power is transferred to Side 2 by a regulated push-pull converter comprising the ADuM3471 (U1), an external transformer (T1 or T2), and other components (see the ADuM347x data sheet for an explanation of this circuit functionality).

### Output Power Connections

An output load can be connected to Pin 1 of J3, labeled +5V/3.3V in the silkscreen and +5V/3.3V OUT in the schematic, which is the isolated, regulated 5 V output supply. Connect the return of the load to Pin 6 of J3, labeled GND ISO, which is the Side 2 ground reference. It is named GND2 in the schematic. Including the current necessary for the ADuM3471 secondary side (I/O and PWM control), this supply can provide up to 500 mA in the default 5 V primary input supply, 5 V secondary isolated supply configuration. The isolated data channels on Side 2 load the secondary isolated supply and reduce the total available current. See the ADuM347x data sheet electrical characteristics for specifications on output supply current to determine how much current the Side 2 I/O lines require at a given data rate. Figure 5 through Figure 8 in this user guide show how the power supply's efficiency varies with load current, switching frequency, and temperature.

### Data I/O Connection

The EVAL-ADuM3471 supports a variety of I/O configurations. The user has access to all four of the ADuM3471 digital isolation channels via the terminals. With an ADuM3471 populated, I/O1 through I/O3 are inputs on Side 1 and outputs on Side 2. I/O4 is an output on Side 1 and an input on Side 2. Table 1 identifies the ADuM3471 pins to which the I/Ox are connected.

Populating J2 allows the user to connect the ADuM3471  $V_{IA}$  input directly to a 50  $\Omega$  signal source. R33 must be shorted with a 0  $\Omega$  resistor to connect the SMA to  $V_{IA}$ . R34, R35, and R36 allow the user to implement various I/O interconnection schemes. For example, soldering 0  $\Omega$  0805s to R34 and R35 ties  $V_{IA}$ ,  $V_{IB}$ , and  $V_{IC}$  together.

Note that R36 must not be populated if an external signal source is applied to I/O3. This can cause permanent damage to the ADuM3471 because an output pin is being driven. R36 can be used to connect  $V_{IC}$  to  $V_{OD}$  so that  $V_{OD}$  drives  $V_{IC}$ . C5 through C7 and C9 should not be populated when an

ADuM3471 is equipped. C8, C10, C11, and C12 are 0603 pads for optional and unpopulated loads for the data outputs.

**Table 1: Single Supply Terminal Function Descriptions**

Terminal	Pin	Label	Description
J1	1	+5V IN	Side 1 +5 V primary input supply
	2	I/O1	V <sub>IA</sub> Logic Input A
	3	I/O2	V <sub>IB</sub> Logic Input B
	4	I/O3	V <sub>IC</sub> Logic Input C
	5	I/O4	V <sub>OD</sub> Logic Output D
	6	GND	Side 1 ground reference
J2	N/A	N/A	SMA connector to J1, I/O1 (V <sub>IA</sub> )
J3	1	+5V/3.3V	Side 2 +5 V secondary isolated supply
	2	I/O1	V <sub>OA</sub> Logic Output A
	3	I/O2	V <sub>OB</sub> Logic Output B
	4	I/O3	V <sub>OC</sub> Logic Output C
	5	I/O4	V <sub>ID</sub> Logic Input D
	6	GND ISO	Side 2 ground reference

The PCB was designed for compatibility with the entire ADuM347x family. If another ADuM347x replaces the ADuM3471, other I/O interconnection schemes are possible. See the ADuM347x data sheet for the pin descriptions of these configurations. These changes are at the discretion of the user. Care must be taken to avoid driving an output pin with an external voltage because this can result in permanent damage to the ADuM347x.

**TRANSFORMER SELECTION**

The EVAL-ADuM3471 supports multiple transformer options. The single supply is equipped with a Halo TGSAD-260V6LF (T1) or a Coilcraft JA4631-BL(T2) 1:2 turns ratio transformer. The Coilcraft footprint is offset to the left of the Halo footprint. Figure 5 and Figure 7 show the efficiency curves for the single supply operating with either transformer.

**SWITCHING FREQUENCY OPTIONS**

The resistor connected from the ADuM3471 OC/oscillator control pin to ground sets the single supply switching frequency. Figure 4 shows the relationship between this resistance and the converter switching frequency. The EVAL-ADuM347x can be configured with 0 Ω 0805s to four different preset switching frequencies. Short-circuiting R30 sets R1 (300 kΩ) and R2 (150 kΩ) in parallel, and short-circuiting R31 sets R1 and R3 (100 kΩ) in parallel. Table 2 lists the switching frequencies that can be selected by short- or open-circuiting R30 and R31.

The user can select a different switching frequency by removing R30 and R31 and then choosing R1 based on Figure 4. The board is configured for the 500 kHz setting by default. Figure 5 and Figure 7 show how the switching frequency affects the supply’s efficiency with either transformer equipped. Figure 6 shows how the efficiency curve varies over temperature with a 500 kHz switching frequency.

**Table 2. Switching Frequency Selection**

R30	R31	R <sub>oc</sub>	Switching Frequency
Open	Open	300 kΩ	200 kHz
0 Ω	Open	100 kΩ	500 kHz
Open	0 Ω	75 kΩ	700 kHz
0 Ω	0 Ω	50 kΩ	1 MHz

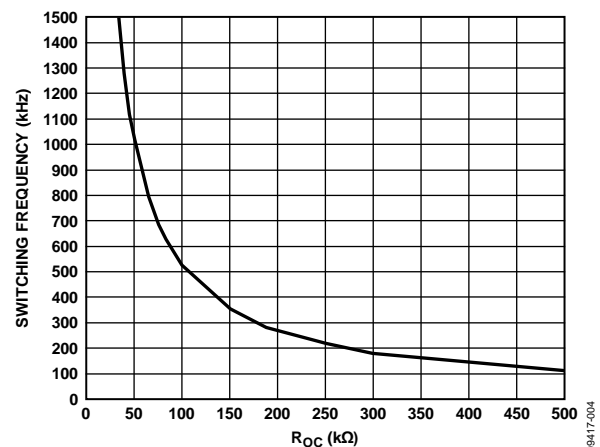

Figure 4. Switching Frequency vs. R<sub>oc</sub> Resistance

**OTHER INPUT AND ISOLATED OUTPUT SUPPLY OPTIONS**

The single supply can be configured to have a 3.3 V secondary isolated supply with a 3.3 V or 5 V primary input supply. Short-circuiting R4 by soldering a 0 Ω 0805 to R32 sets the output supply for 3.3 V. The voltage at the feedback node (the FB pin of the ADuM3471) should be the desired output voltage divided to approximately 1.25 V. Having R32 open-circuited sets the secondary isolated supply to 5 V, and having it short-circuited sets the supply to 3.3 V. See the ADuM347x data sheet for more details on setting the secondary isolated output supply voltage. Figure 8 shows how the single supply’s efficiency curve changes when it is reconfigured for either of these supply options.

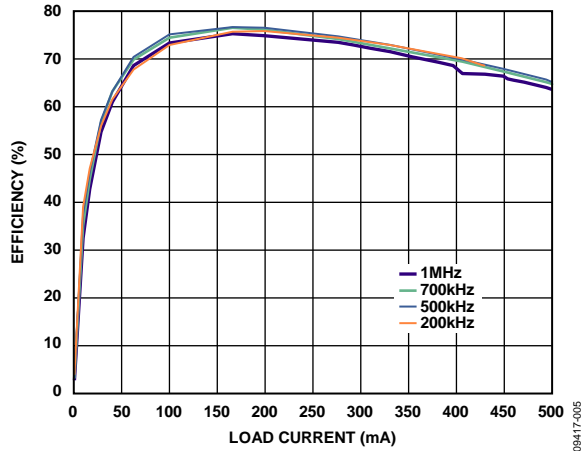

Figure 5. 5 V In to 5 V Out Efficiency with the Coilcraft Transformer at Various Switching Frequencies

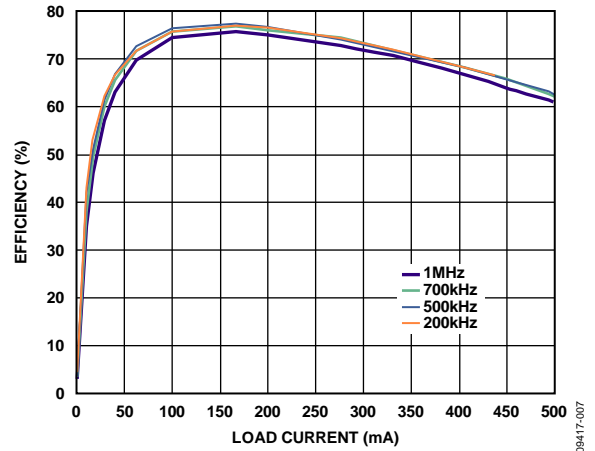

Figure 7. 5 V In to 5 V Out Efficiency with the Halo Transformer at Various Switching Frequencies

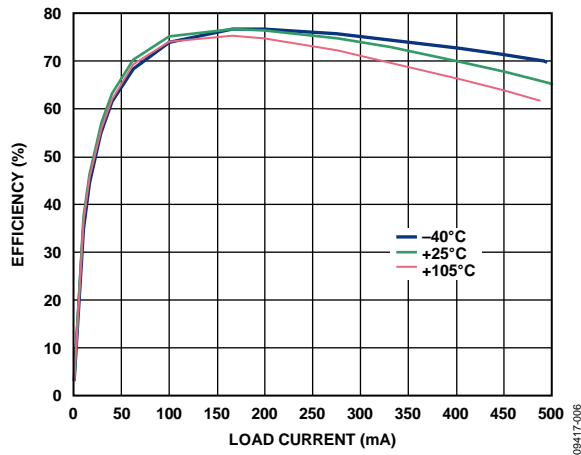

Figure 6. 5 V In to 5 V Out Efficiency with the Coilcraft Transformer at 500 kHz over Temperature

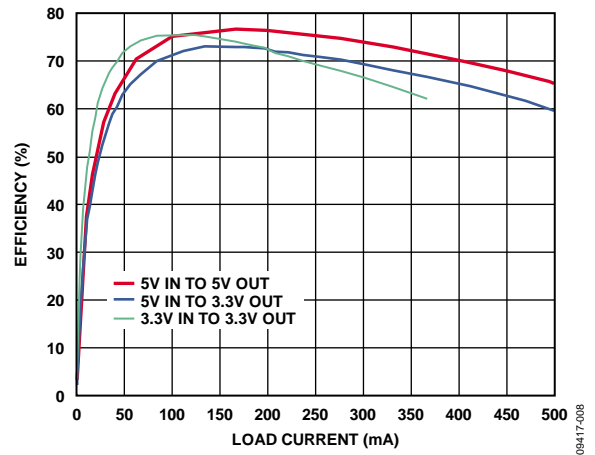

Figure 8. Single Supply Efficiency for Various Output Configurations with the Coilcraft Transformer at 500 kHz

SCHMATIC

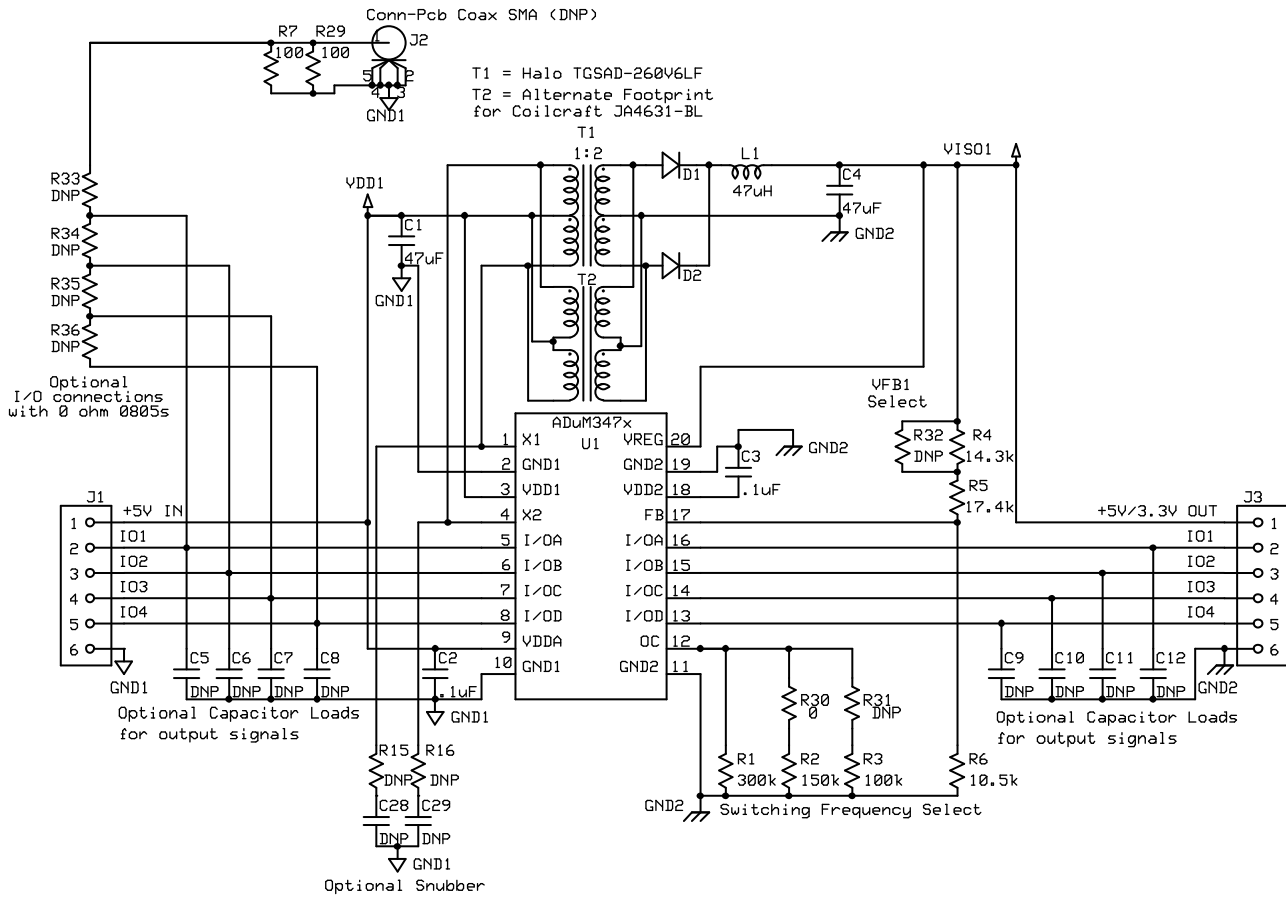

Figure 9. Single Supply Schematic

09417-009

## DOUBLE SUPPLY

The second power supply implemented with the ADuM3471 on this evaluation board is a double supply. This circuit, which is shown in Figure 10, is located on the top half of the board. The ADuM347x data sheet also discusses the ADuM347x in this configuration. Figure 17 shows the schematic.

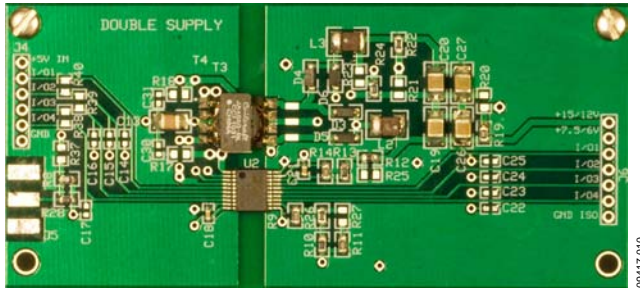

Figure 10. Double Supply

In its default configuration, the double supply provides a regulated 15 V output and an unregulated 7.5 V output, which are isolated from the 5 V primary input supply. The double supply is capable of delivering up to 140 mA to external loads. The isolated data channels on Side 2 load the secondary isolated supply and reduce the total available current. See the ADuM347x data sheet electrical characteristics for specifications on output supply current to determine how much current the Side 2 I/O lines require at a given data rate. It can be reconfigured as 12 V (regulated) and 6 V (unregulated) secondary isolated supplies or as positive and negative supplies. See the Other Secondary Isolated Supply Configurations section for more details.

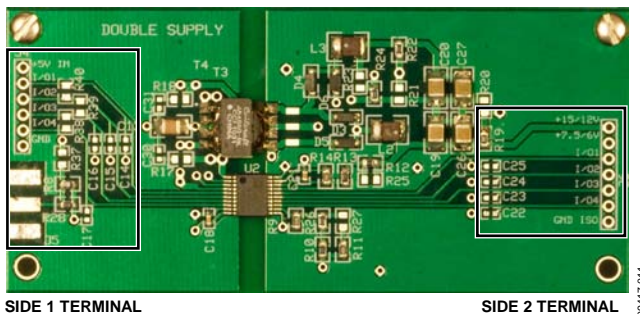

Figure 11. Double Supply Terminals

### TERMINALS

The double supply has terminal blocks on Side 1 (the primary/power supply input side) and Side 2 (the secondary/power supply output side). A 4.3 mm isolation barrier separates Side 1 and Side 2. Figure 11 shows these terminals. Although the board is populated with the ADuM3471, it is designed to accommodate the entire ADuM347x family. Therefore, the silkscreen shows I/Ox to denote the four iCoupler data channels. J4 is a 0.1 inch (2.54 mm) 6x1 header, and J6 is a 0.1 inch 7x1 header. J5 has pads for an optional SMA connector (not populated) terminated into 50  $\Omega$ . Table 3 summarizes the functions of the terminal connections. They are described in detail in the Input

Power Connections, Output Power Connections, and Data I/O Connection sections.

### Input Power Connections

Connect +5 V to Pin 1 of J4, labeled +5V IN. Connect the supply negative to Pin 6, labeled GND (GND3 in the schematic). These are the only off-board connections required for the double supply to function.

+5V IN supplies  $V_{DD1}$  and  $V_{DDA}$  to U2, the double supply ADuM3471.  $V_{DD1}$  is the ADuM3471 transformer driver supply, and  $V_{DDA}$  is its primary supply voltage (see the ADuM347x data sheet for additional information about these pin functions).  $V_{DD1}/V_{DDA}$  is bypassed by a 47  $\mu$ F ceramic capacitor, labeled C13, and a 0.1  $\mu$ F local bypass capacitor located close to the ADuM3471 (C18). R17, R18, C30, and C31 are provided for an optional and unpopulated snubber, which can be used to reduce radiated emissions.

### Output Power Connections

An output load can be connected to Pin 1 of J6, labeled VISO2 in the schematic and +15/12V in the silkscreen, which is the isolated, regulated 15 V output supply. Connect the return of the load to Pin 7 of J6. It is labeled GND ISO on the silkscreen and GND4 in the schematic.

Side 2 is powered by the secondary isolated 15 V supply. The ADuM3471 internal low-dropout regulator converts this voltage to 5 V. The regulated 5 V supply powers the ADuM3471 secondary side. Therefore, the ADuM3471  $V_{REG}$  pin is 15 V, and the  $V_{DD2}$  pin is 5 V. The 15 V supply connects to Pin 1 of J6. The 7.5 V supply connects to Pin 2 of J6, which is labeled +7.5V/6V on the silkscreen and VISO1 on the schematic. The Side 2 ground reference is tied to Pin 7 of J6. Note that the single and double supplies do not share grounds, though they have the same names on the silkscreen. The two supplies are isolated from each other with an over 15 mm gap. See the ADuM347x data sheet for an explanation of the double supply theory of operation. Figure 12 through Figure 15 shows efficiency curves for the double supply with the +15/+12 V isolated output supply connected to  $V_{REG}$ .

### Powering $V_{REG}$ from the Unregulated 7.5 V

$V_{REG}$  can be powered by the unregulated 7.5 V supply, which results in higher efficiency. However, when the 15 V supply is unloaded, the unregulated 7.5 V supply is approximately 3 V, which is not high enough to power the ADuM3471 secondary side. This causes the double supply to run open loop, leaving the 15 V supply unregulated. Because the secondary side of the ADuM3471 is not sufficiently powered, its data channels are inoperable. Using 15 V for  $V_{REG}$  ensures that the secondary side of the ADuM3471 powers up under light load conditions. Move the 0  $\Omega$  0805 from R19 to R20 to power Side 2 from the 7.5 V supply.

### Data I/O Connection

The EVAL-ADuM3471 supports a variety of I/O configurations. The user has access to all four of the ADuM3471 isolated data channels via the terminals. With an ADuM3471 populated, I/O1 through I/O3 are inputs on Side 1 and outputs on Side 2. I/O4 is an output on Side 1 and an input on Side 2. Table 3 identifies the ADuM3471 pins to which the I/Ox are connected.

Populating J5 allows the user to connect the ADuM3471  $V_{IA}$  input directly to a 50  $\Omega$  signal source. R37 must be shorted with a 0  $\Omega$  resistor to connect the SMA to  $V_{IA}$ . R38, R39, and R40 allow the user to implement various I/O interconnection schemes. For example, soldering 0  $\Omega$  0805s to R40 and R39 ties  $V_{IA}$ ,  $V_{IB}$ , and  $V_{IC}$  together.

Note that R38 must not be populated if an external signal source is applied to I/O3. This can cause permanent damage to the ADuM3471 because an output pin is being driven. R38 can be used to connect  $V_{IC}$  to  $V_{OD}$  so that  $V_{OD}$  drives  $V_{IC}$ . C14 through C16 and C22 should not be populated. C17, C23, C24, and C25 are 0603 pads provided for optional and unpopulated loads for the data outputs. Though the I/Ox for the single and double supplies share names on the silkscreen, they are not connected.

The PCB is designed for compatibility with the entire ADuM347x family. If the ADuM3471 is replaced by another ADuM347x, other I/O interconnection schemes are possible (see the ADuM347x data sheet for the pin descriptions of these configurations). These changes are at the discretion of the user. Care must be taken to avoid driving an output pin because this can result in permanent damage to the ADuM347x.

**Table 3. Double Supply Terminal Function Descriptions**

Terminal	Pin	Label	Description
J4	1	+5V IN	Side 1 +5 V primary input supply
	2	I/O1	$V_{IA}$ Logic Input A
	3	I/O2	$V_{IB}$ Logic Input B
	4	I/O3	$V_{IC}$ Logic Input C
	5	I/O4	$V_{OD}$ Logic Output D
	6	GND	Side 1 ground reference
J5	N/A	N/A	SMA connector to J4, I/O1 ( $V_{IA}$ )
J6	1	+15V/12V	Side 2 +15 V secondary isolated supply (regulated)
	2	+7.5V/6V	Side 2 +7.5 V secondary isolated supply (unregulated)
	3	I/O1	$V_{OA}$ Logic Output A
	4	I/O2	$V_{OB}$ Logic Output B
	5	I/O3	$V_{OC}$ Logic Output C
	6	I/O4	$V_{ID}$ Logic Input D
	7	GND ISO	Side 2 ground reference

### TRANSFORMER SELECTION

The EVAL-ADuM3471 supports multiple transformer options. The double supply is equipped with a Halo TGSAD-290V6LF (T3) or a Coilcraft JA4650-BL (T4) 1:3 turns ratio transformer. The Coilcraft footprint is directly to the left of the Halo footprint (see the ADuM347x data sheet for a detailed discussion of transformer selection with the ADuM347x). Figure 12 and Figure 14 show the supply's efficiency with either transformer at different switching frequencies. Figure 13 shows how temperature affects efficiency.

### SWITCHING FREQUENCY OPTIONS

The resistor connected from the ADuM3471 OC/oscillator control pin to ground sets the double supply switching frequency. Figure 4 shows the relationship between this resistance and the converter switching frequency. The EVAL-ADuM347x can be configured with 0  $\Omega$  0805s to four different preset switching frequencies. Short-circuiting R26 sets R9 (300 k $\Omega$ ) and R10 (150 k $\Omega$ ) in parallel, and short-circuiting R27 sets R9 and R11 (100 k $\Omega$ ) in parallel. Table 4 lists the switching frequencies that can be selected by short- or open-circuiting R26 and R27. The user can select a different switching frequency by removing R26 and R27 and then choosing R9 based on Figure 4. The board is configured for the 500 kHz setting by default. Figure 12 and Figure 14 show how the switching frequency affects the efficiency with either transformer.

**Table 4. Switching Frequency Selection**

R26	R27	R <sub>oc</sub>	Switching Frequency
Open	Open	300 k $\Omega$	200 kHz
0 $\Omega$	Open	100 k $\Omega$	500 kHz
Open	0 $\Omega$	75 k $\Omega$	700 kHz
0 $\Omega$	0 $\Omega$	50 k $\Omega$	1 MHz



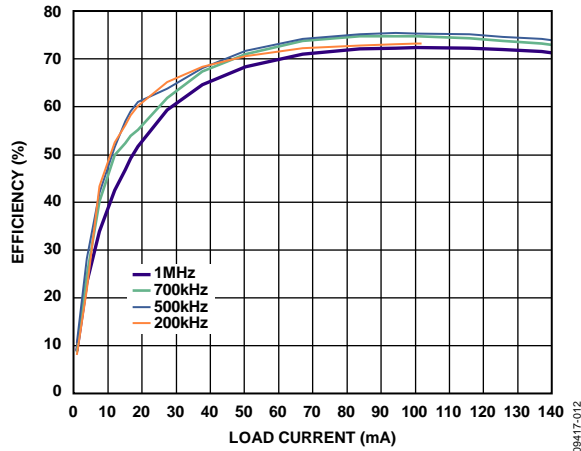

Figure 12. 5 V In to 15 V Out Efficiency with the Coilcraft Transformer at Various Switching Frequencies

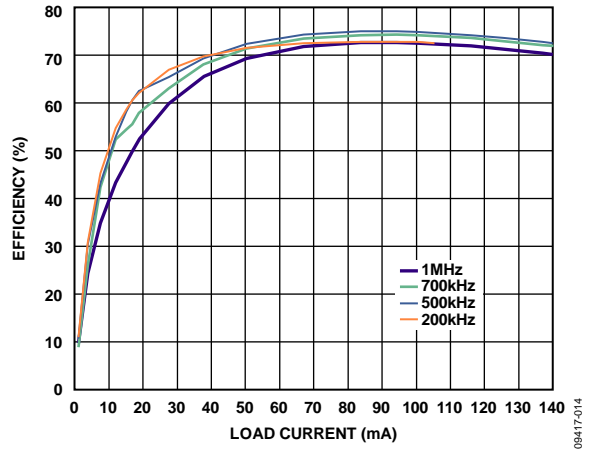

Figure 14. 5 V In to 15 V Out Efficiency with the Halo Transformer at Various Switching Frequencies

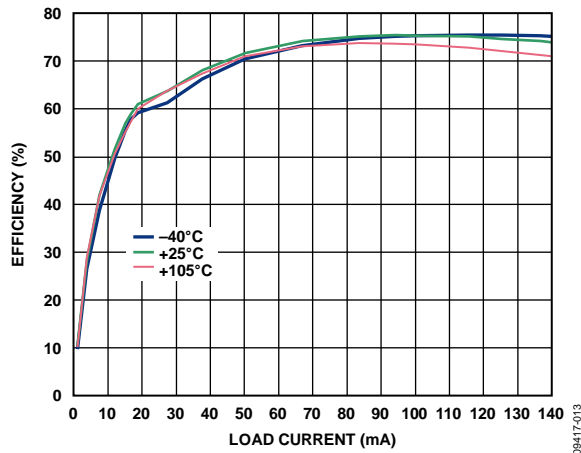

Figure 13. 5 V In to 15 V Out Efficiency with the Coilcraft Transformer at 500 kHz and Various Temperatures

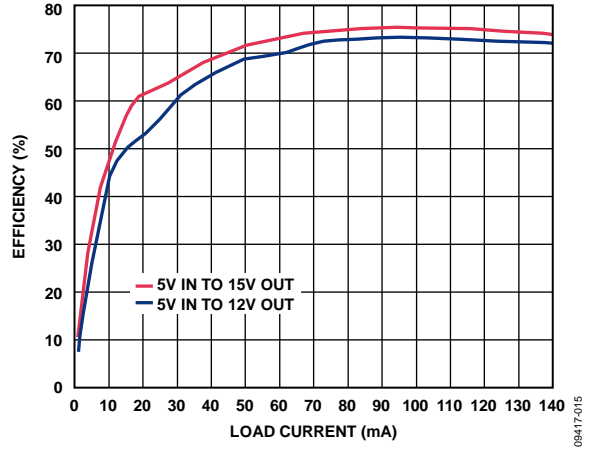

Figure 15. Double Supply Efficiency with the Coilcraft Transformer for Different Output Options at 500 kHz

**OTHER SECONDARY ISOLATED SUPPLY CONFIGURATIONS**

The double supply can be configured for 12 V regulated and 6 V unregulated secondary isolated supplies by short-circuiting R12 with a 0 Ω resistor for R25. The regulated supply voltage is set by the fraction of it that is fed back to the ADuM3471 via the voltage divider comprising R12, R13, R14, and R25. The voltage at the feedback pin is 1.25 V. With R25 open-circuited, the ADuM3471 feedback voltage is approximately 1.25 V if VISO2 is 15 V. When R25 is short-circuited, the feedback voltage is approximately 1.25 V if VISO2 is 12 V (see the ADuM347x data sheet for more details on setting the secondary isolated output supply voltage). Figure 15 shows the efficiency curves for both output settings at 500 kHz with the Coilcraft transformer.

**Positive and Negative Outputs**

The double supply can be set up as a positive and negative ±15 V supply by changing the transformer to a turns ratio CT1:CT5 transformer (see the ADuM347x data sheet for more information on these transformers). Other changes begin with removing the 0 Ω resistors from R24 and R22 to R23 and R21. Short-circuiting R23 instead of R24 makes the +7.5 V/6 V pin of J6 become the

–15 V supply. Short-circuiting R21 instead of R22 connects the transformer center tap to the ground plane instead of the node where L3, C20, and C27 are connected. Figure 16 shows which resistors should be short-circuited and open-circuited for the double supply or positive and negative supply configurations. Note that the negative supply is unregulated. The positive and negative supply can be set for ±12 V instead of ±15 V by short-circuiting R25.

Whereas the +15 V output can be regulated, the same problems with regulation can happen as described in the Powering VREG from the Unregulated 7.5 V section. In addition, the –15 V supply can vary over a wide range because it is unregulated and influenced by the changes that happen on the +15 V output.

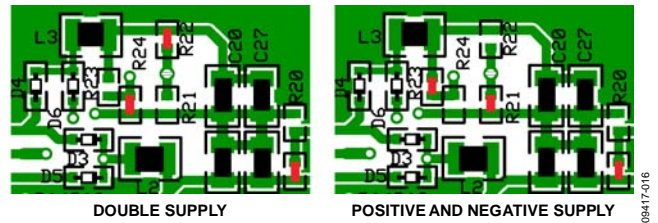

Figure 16. Double Supply Configuration with 0 Ω Resistors (Red)

**SCHEMATIC**

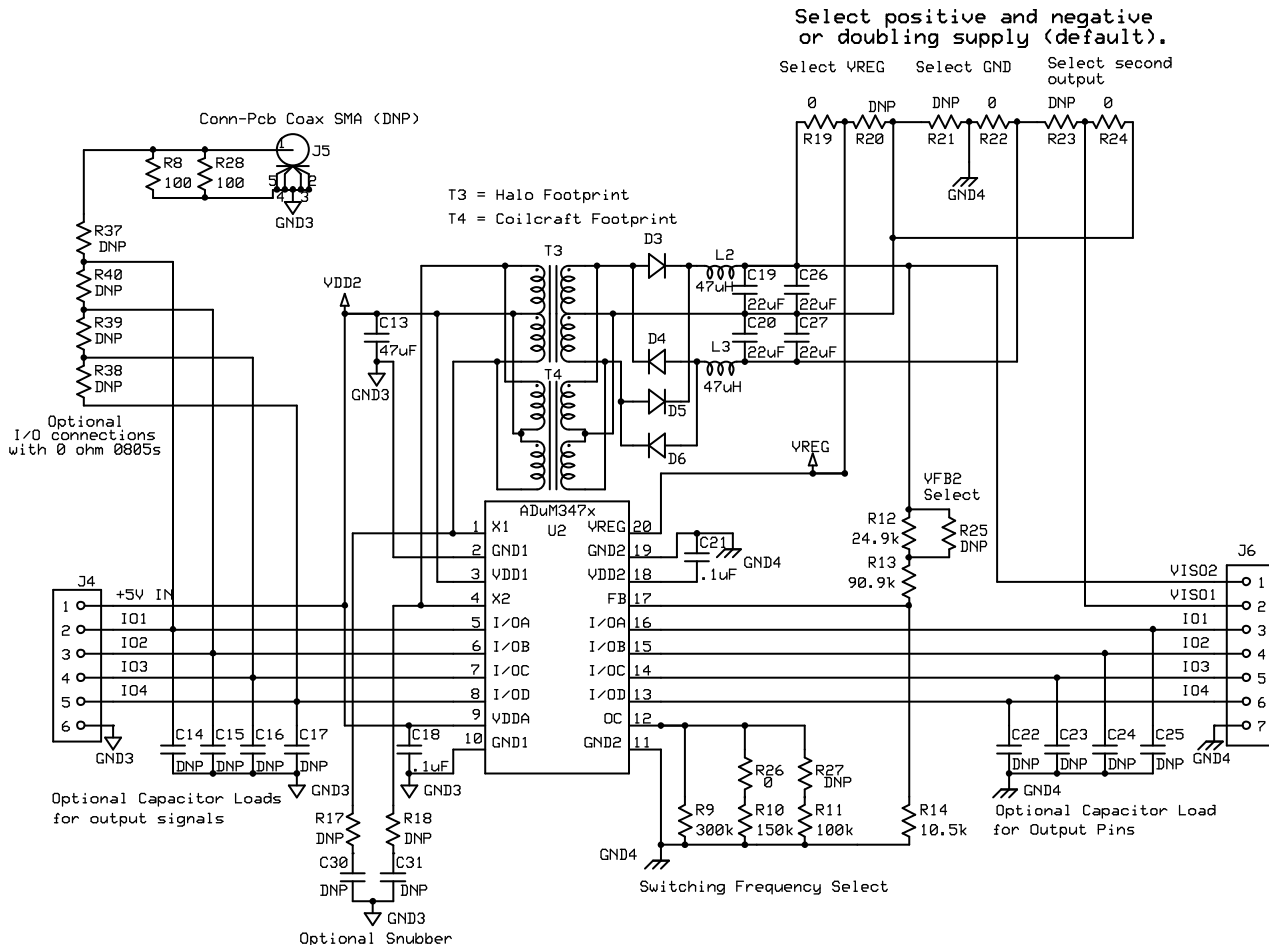

Figure 17. Double Supply Schematic

# EVALUATION BOARD LAYOUT

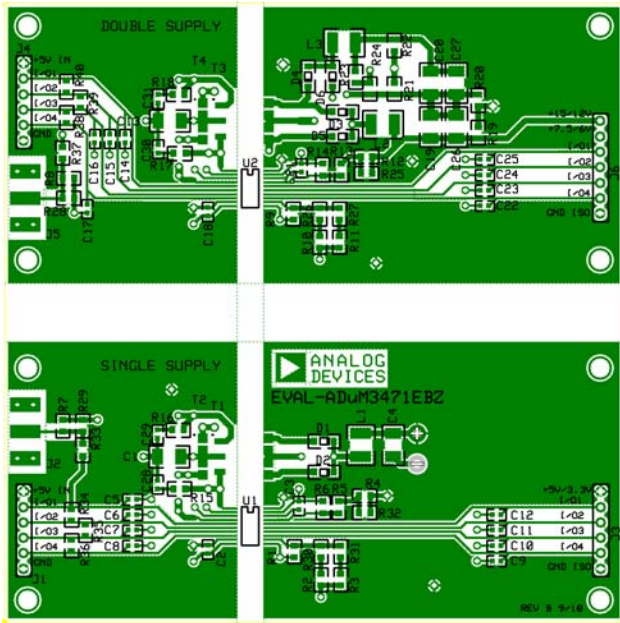

Figure 18. Top Layer: Power Fill

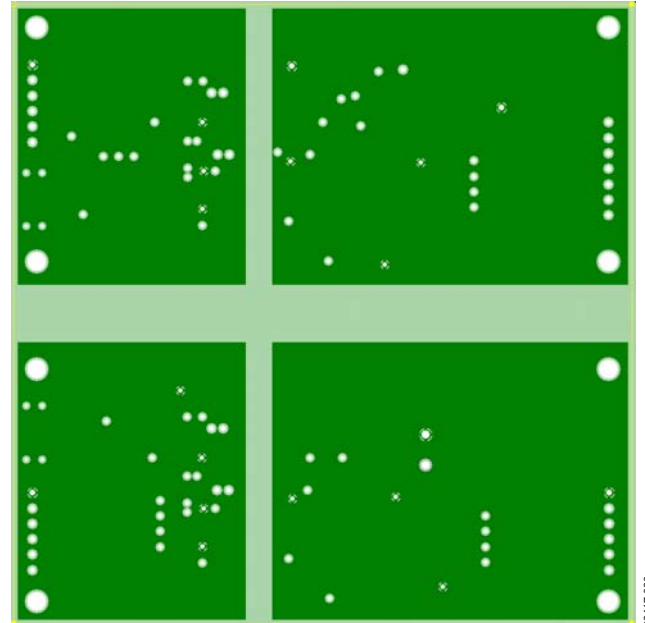

Figure 20. Layer 3: Power Plane

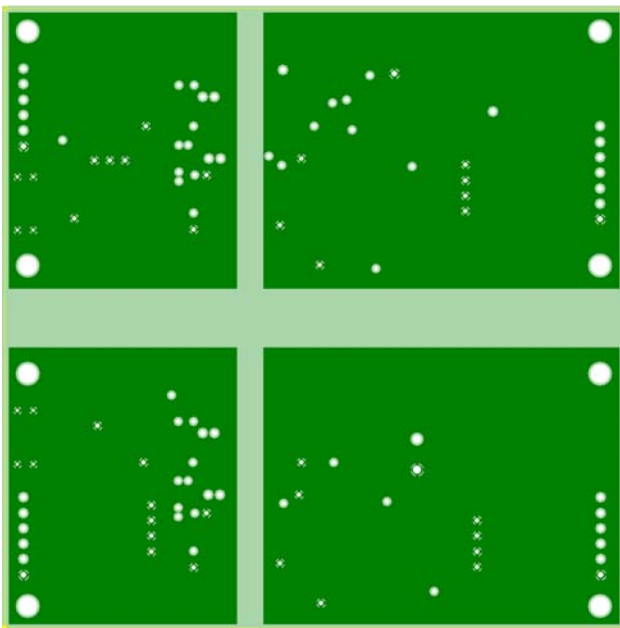

Figure 19. Layer 2: Ground Plane

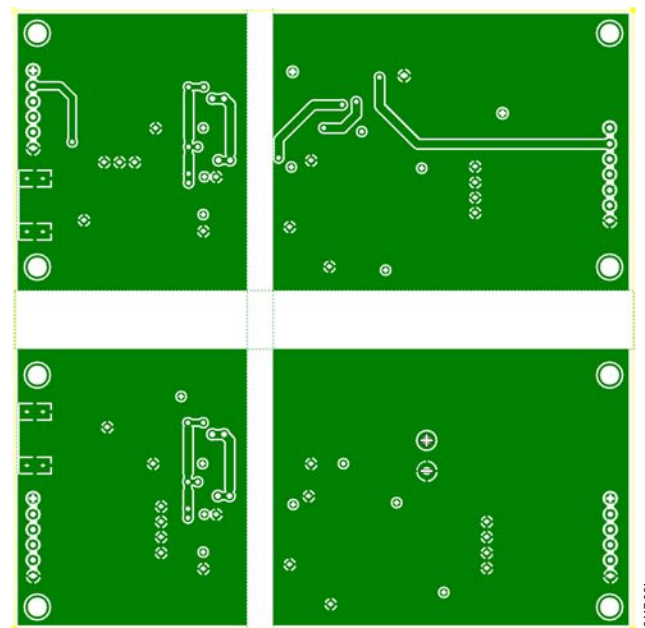

Figure 21. Bottom Layer: Ground Fill

## ORDERING INFORMATION

## BILL OF MATERIALS

Table 5.

Qty	Reference Designator	Description	Supplier/Part Number
3	J1, J4, J3	CON-PCB terminal, 6x1 header, 0.1 inch spacing	Sullins Connector Solutions
1	J6	CON-PCB terminal, 7x1 header, 0.1 inch spacing	Sullins Connector Solutions
2	U1, U2	ADuM3471	Analog Devices, Inc.
6	D1 to D6	Schottky barrier rectifier, 0.5 A, 40 V, SMD, SOD-123	ON Semi/MBR0540
1 <sup>1</sup>	T1	Transformer, 1:2 turns ratio, SMD	Halo/TGSAD-260V6LF
1 <sup>1</sup>	T2	Transformer, 1:2 turns ratio, SMD	Coilcraft/JA4631-BL
1 <sup>1</sup>	T3	Transformer, 1:3 turns ratio, SMD	Halo/TGSAD-290V6LF
1 <sup>1</sup>	T4	Transformer, 1:3 turns ratio, SMD	Coilcraft/JA4650-BL
4	C2, C3, C18, C21	CAP CER, X7R, SMD, 0603, 0.1 μF	AVX/0603YC104KAT2A
0	C5 to C12, C14 to C17, C22 to C25	CAP CER, SMD 0603, not populated	N/A
3	C1, C4, C13	CAP CER, X7R, SMD, 1210, 47 μF, 20%, 10 V	Murata/GRM32ER71A476KE15L
4	C19, C20, C26, C27	CAP CER, X7R, SMD, 1210, 22 μF, 20% 16 V	Murata/GRM32ER71C226KE18L
4	C28 to C31	CAP CER, SMD 0603, not populated	N/A
3	L1 to L3	Inductor, SMD 1212; 47 μH, 20%, 1.25 Ω	Murata/LQH3NPN470MM0
4	R7, R8, R28, R29	RES chip, SMD 0805, 100 Ω, 1/8W, 1%	Yageo/RC0805FR-07100RL
2	R1, R9	RES chip, SMD 0805, 300 kΩ, 1/8W, 1%	Yageo/RC0805FR-07300KL
2	R2, R10	RES chip, SMD 0805, 150 kΩ, 1/8W, 1%	Yageo/RC0805FR-07150KL
2	R3, R11	RES chip, SMD 0805, 100 kΩ, 1/8W, 1%	Panasonic – ECG/ERJ-6ENF1003V
2	R6, R14	RES chip, SMD 0805, 10.5 kΩ, 1/8W, 1%	Panasonic – ECG/ERJ-6ENF1052V
1	R4	RES chip, SMD 0805, 14.3 kΩ, 1/8W, 1%	Panasonic – ECG/ERJ-6ENF1432V
1	R5	RES chip, SMD 0805, 17.4 kΩ, 1/8W, 1%	Panasonic – ECG/ERJ-6ENF1742V
1	R12	RES chip, SMD 0805, 24.9 kΩ, 1/8W, 1%	Panasonic – ECG/ERJ-6ENF2492V
1	R13	RES chip, SMD 0805, 90.9 kΩ, 1/8W, 1%	Panasonic – ECG/ERJ-6ENF9092V
5	R19, R22, R24, R26, R30	RES chip, SMD 0805, 0 Ω, 1/8W	Panasonic – ECG/ERJ-6GEY0R00V
0	R15 to R18, R20, R21, R23, R25, R27, R31 to R40	Not populated	N/A
0	J2, J5	CON-PCB, SMA, not populated	N/A

<sup>1</sup> The board is populated with either Coilcraft or Halo transformers. Do not populate both T1 and T2 or T3 and T4.

**NOTES**

**NOTES**

**NOTES**

## NOTES

**ESD Caution**

**ESD (electrostatic discharge) sensitive device.** Charged devices and circuit boards can discharge without detection. Although this product features patented or proprietary protection circuitry, damage may occur on devices subjected to high energy ESD. Therefore, proper ESD precautions should be taken to avoid performance degradation or loss of functionality.

**Legal Terms and Conditions**

By using the evaluation board discussed herein (together with any tools, components documentation or support materials, the "Evaluation Board"), you are agreeing to be bound by the terms and conditions set forth below ("Agreement") unless you have purchased the Evaluation Board, in which case the Analog Devices Standard Terms and Conditions of Sale shall govern. Do not use the Evaluation Board until you have read and agreed to the Agreement. Your use of the Evaluation Board shall signify your acceptance of the Agreement. This Agreement is made by and between you ("Customer") and Analog Devices, Inc. ("ADI"), with its principal place of business at One Technology Way, Norwood, MA 02062, USA. Subject to the terms and conditions of the Agreement, ADI hereby grants to Customer a free, limited, personal, temporary, non-exclusive, non-sublicensable, non-transferable license to use the Evaluation Board FOR EVALUATION PURPOSES ONLY. Customer understands and agrees that the Evaluation Board is provided for the sole and exclusive purpose referenced above, and agrees not to use the Evaluation Board for any other purpose. Furthermore, the license granted is expressly made subject to the following additional limitations: Customer shall not (i) rent, lease, display, sell, transfer, assign, sublicense, or distribute the Evaluation Board; and (ii) permit any Third Party to access the Evaluation Board. As used herein, the term "Third Party" includes any entity other than ADI, Customer, their employees, affiliates and in-house consultants. The Evaluation Board is NOT sold to Customer; all rights not expressly granted herein, including ownership of the Evaluation Board, are reserved by ADI. CONFIDENTIALITY. This Agreement and the Evaluation Board shall all be considered the confidential and proprietary information of ADI. Customer may not disclose or transfer any portion of the Evaluation Board to any other party for any reason. Upon discontinuation of use of the Evaluation Board or termination of this Agreement, Customer agrees to promptly return the Evaluation Board to ADI. ADDITIONAL RESTRICTIONS. Customer may not disassemble, decompile or reverse engineer chips on the Evaluation Board. Customer shall inform ADI of any occurred damages or any modifications or alterations it makes to the Evaluation Board, including but not limited to soldering or any other activity that affects the material content of the Evaluation Board. Modifications to the Evaluation Board must comply with applicable law, including but not limited to the RoHS Directive. TERMINATION. ADI may terminate this Agreement at any time upon giving written notice to Customer. Customer agrees to return to ADI the Evaluation Board at that time. LIMITATION OF LIABILITY. THE EVALUATION BOARD PROVIDED HEREUNDER IS PROVIDED "AS IS" AND ADI MAKES NO WARRANTIES OR REPRESENTATIONS OF ANY KIND WITH RESPECT TO IT. ADI SPECIFICALLY DISCLAIMS ANY REPRESENTATIONS, ENDORSEMENTS, GUARANTEES, OR WARRANTIES, EXPRESS OR IMPLIED, RELATED TO THE EVALUATION BOARD INCLUDING, BUT NOT LIMITED TO, THE IMPLIED WARRANTY OF MERCHANTABILITY, TITLE, FITNESS FOR A PARTICULAR PURPOSE OR NON-INFRINGEMENT OF INTELLECTUAL PROPERTY RIGHTS. IN NO EVENT WILL ADI AND ITS LICENSORS BE LIABLE FOR ANY INCIDENTAL, SPECIAL, INDIRECT, OR CONSEQUENTIAL DAMAGES RESULTING FROM CUSTOMER'S POSSESSION OR USE OF THE EVALUATION BOARD, INCLUDING BUT NOT LIMITED TO LOST PROFITS, DELAY COSTS, LABOR COSTS OR LOSS OF GOODWILL. ADI'S TOTAL LIABILITY FROM ANY AND ALL CAUSES SHALL BE LIMITED TO THE AMOUNT OF ONE HUNDRED US DOLLARS (\$100,000). EXPORT. Customer agrees that it will not directly or indirectly export the Evaluation Board to another country, and that it will comply with all applicable United States federal laws and regulations relating to exports. GOVERNING LAW. This Agreement shall be governed by and construed in accordance with the substantive laws of the Commonwealth of Massachusetts (excluding conflict of law rules). Any legal action regarding this Agreement will be heard in the state or federal courts having jurisdiction in Suffolk County, Massachusetts, and Customer hereby submits to the personal jurisdiction and venue of such courts. The United Nations Convention on Contracts for the International Sale of Goods shall not apply to this Agreement and is expressly disclaimed.





Компания «ЭлектроПласт» предлагает заключение долгосрочных отношений при поставках импортных электронных компонентов на взаимовыгодных условиях!

Наши преимущества:

- Оперативные поставки широкого спектра электронных компонентов отечественного и импортного производства напрямую от производителей и с крупнейших мировых складов;
- Поставка более 17-ти миллионов наименований электронных компонентов;
- Поставка сложных, дефицитных, либо снятых с производства позиций;
- Оперативные сроки поставки под заказ (от 5 рабочих дней);
- Экспресс доставка в любую точку России;
- Техническая поддержка проекта, помощь в подборе аналогов, поставка прототипов;
- Система менеджмента качества сертифицирована по Международному стандарту ISO 9001;
- Лицензия ФСБ на осуществление работ с использованием сведений, составляющих государственную тайну;
- Поставка специализированных компонентов (Xilinx, Altera, Analog Devices, Intersil, Interpoint, Microsemi, Aeroflex, Peregrine, Syfer, Eurofarad, Texas Instrument, Miteq, Cobham, E2V, MA-COM, Hittite, Mini-Circuits, General Dynamics и др.);

Помимо этого, одним из направлений компании «ЭлектроПласт» является направление «Источники питания». Мы предлагаем Вам помощь Конструкторского отдела:

- Подбор оптимального решения, техническое обоснование при выборе компонента;
- Подбор аналогов;
- Консультации по применению компонента;
- Поставка образцов и прототипов;
- Техническая поддержка проекта;
- Защита от снятия компонента с производства.



#### Как с нами связаться

**Телефон:** 8 (812) 309 58 32 (многоканальный)

**Факс:** 8 (812) 320-02-42

**Электронная почта:** [org@eplast1.ru](mailto:org@eplast1.ru)

**Адрес:** 198099, г. Санкт-Петербург, ул. Калинина, дом 2, корпус 4, литера А.