

Tous droits strictement réservés. Reproduction ou communication a des tiers interdite sous quelque forme que ce soit sans autorisation écrite du propriétaire. Propriété de c FCI. Droits de reproduction FCI.

All rights strictly reserved. Reproduction or issue to third parties in any form whatever is not permitted without written authority from the proprietor. Property of FCI. Copyright FCI.

PRODUCT NO.	ROWS	POWER				SIGNAL				POWER				E1		
		E2	P7	P6	P5	6	5	4	3	2	1	P4	P3		P2	P1
51897-005-- NOTE:3	D C B A															
		PH	PH	PG	F	F	F	F	F	F	F	PF	PF	PF	PF	HA
					F	F	F	F	F	F	F	F				

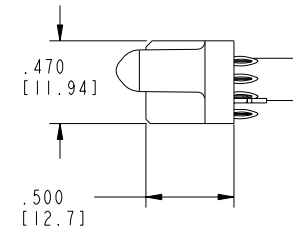
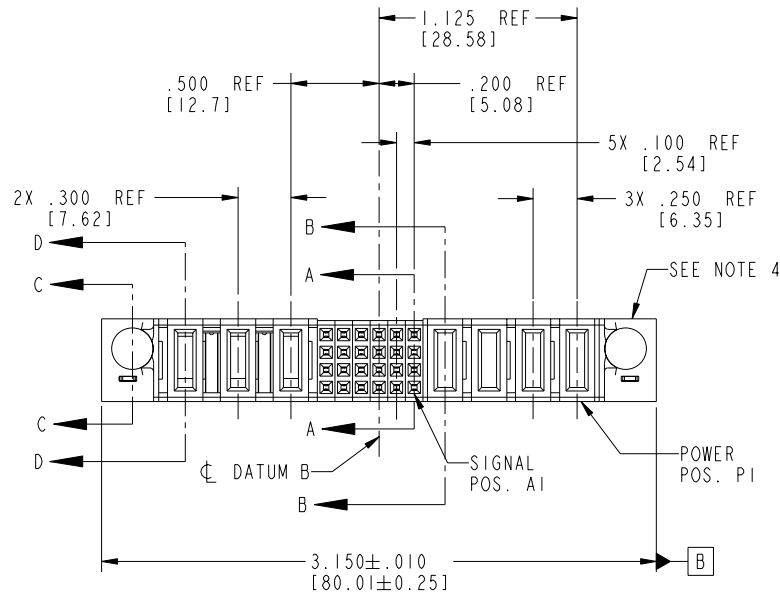
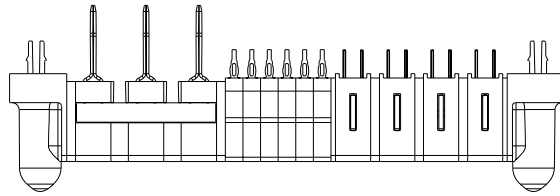

CODE	DIM "M" MATING LENGTH	CONTACT TYPE
PH	.092 [2.34]	POWER
PF	.092 [2.34]	POWER
F	N/A [N/A]	SIGNAL
HA	N/A [N/A]	HOLD-DOWN
PG	.042 [1.07]	POWER

mat'l code				SEE NOTE 2		tolerances unless otherwise specified		CUSTOMER		FCI	
ltr	ecn no.	dr	date	linear	.XX±.01/0.X±0.3	projection		www.fciconnect.com			
A	V03-0339	DAI	03/25/03	linear	.XXX±.005/0.XX±0.13	INCH/MM		title 4P + 24S + 3ACP			
B	DG05-0341	CS	09/23/05	angles	.XXX±.0020/0.XXX±0.051	1:1		VERTICAL PRESS FIT RECEIPT CABLE PORT			
				dr	D. INGRAM 03/25/03	scale		product family PwrBlade code			
				enr	M. MOSTOLLER 03/25/03	A		size 51897-005 code 213			
				chr	M. MOSTOLLER 03/25/03			sheet 1 of 4			
				appd	M. MOSTOLLER 03/25/03						
sheet index	revision sheet	B 1	B 2	B 3	B 4						

cage code 22526 4

PDM: Rev:B

STATUS:Released

Printed: Dec 20, 2010

Tous droits strictement réservés. Reproduction ou communication a des tiers interdite sous quelque forme que ce soit sans autorisation écrite du propriétaire. Propriété de c FCI. Droits de reproduction FCI.

All rights strictly reserved. Reproduction or issue to third parties in any form whatever is not permitted without written authority from the proprietor. Property of FCI. Copyright FCI.

PRODUCT NUMBER
51897-005__
NOTE: 3

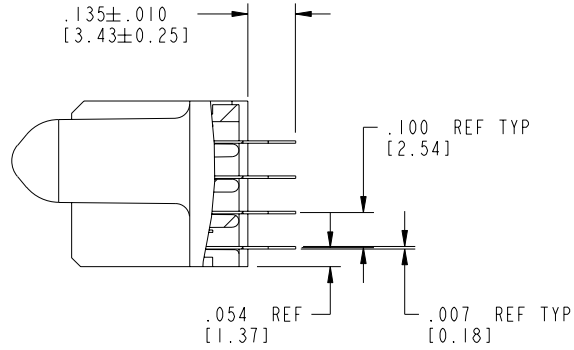

SECTION A-A
SCALE 2:1

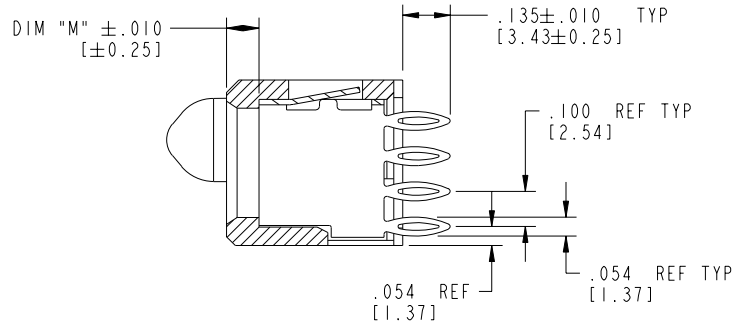

SECTION B-B
SCALE 2:1

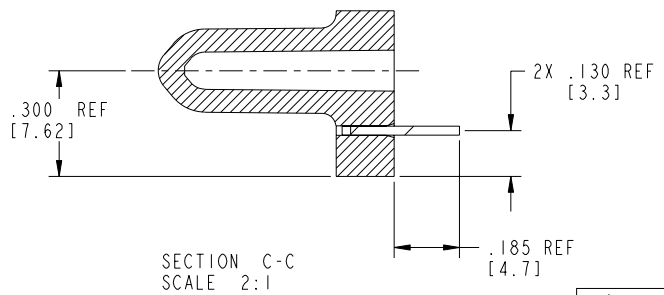

SECTION C-C
SCALE 2:1

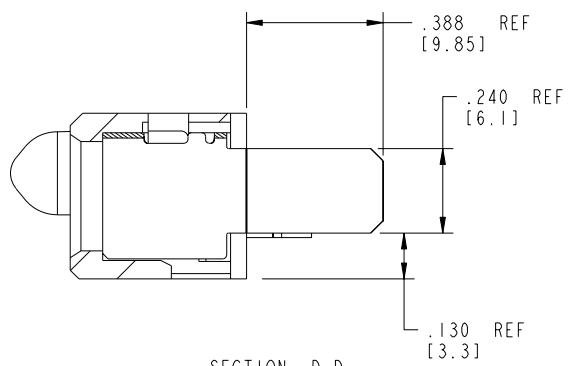

SECTION D-D
SCALE 2:1

mat'l code		SEE NOTE 2		tolerances unless otherwise specified		CUSTOMER		 www.fciconnect.com	
ltr	ecn no.	dr	date	linear	.XX±.01/0.X±0.3	COPY		projection	title
B					.XXX±.005/0.XX±0.13				4P + 24S + 3ACP
				angles	.XXX±.0020/0.XXX±0.051				VERTICAL PRESS FIT RECEIPT CABLE PORT
				dr	0°±2°				product family
				engr	D. INGRAM 03/25/03				PwrBlade
				chr	M. MOSTOLLER 03/25/03			size	code
				appd	M. MOSTOLLER 03/25/03			A	213
sheet index	revision sheet					scale		1:1	dwg no
								51897-005	sheet
									2 of 4

cage code 22526

Pro/E

PDM: Rev:B

STATUS: Released

Printed: Dec 20, 2010

Tous droits strictement réservés. Reproduction ou communication à des tiers interdite sous quelque forme que ce soit sans autorisation écrite du propriétaire. Propriété de c FCI. Droits de reproduction FCI.

All rights strictly reserved. Reproduction or issue to third parties in any form whatever is not permitted without written authority from the proprietor. Property of FCI. Copyright FCI.

PRODUCT NUMBER
51897-005_
NOTE: 3

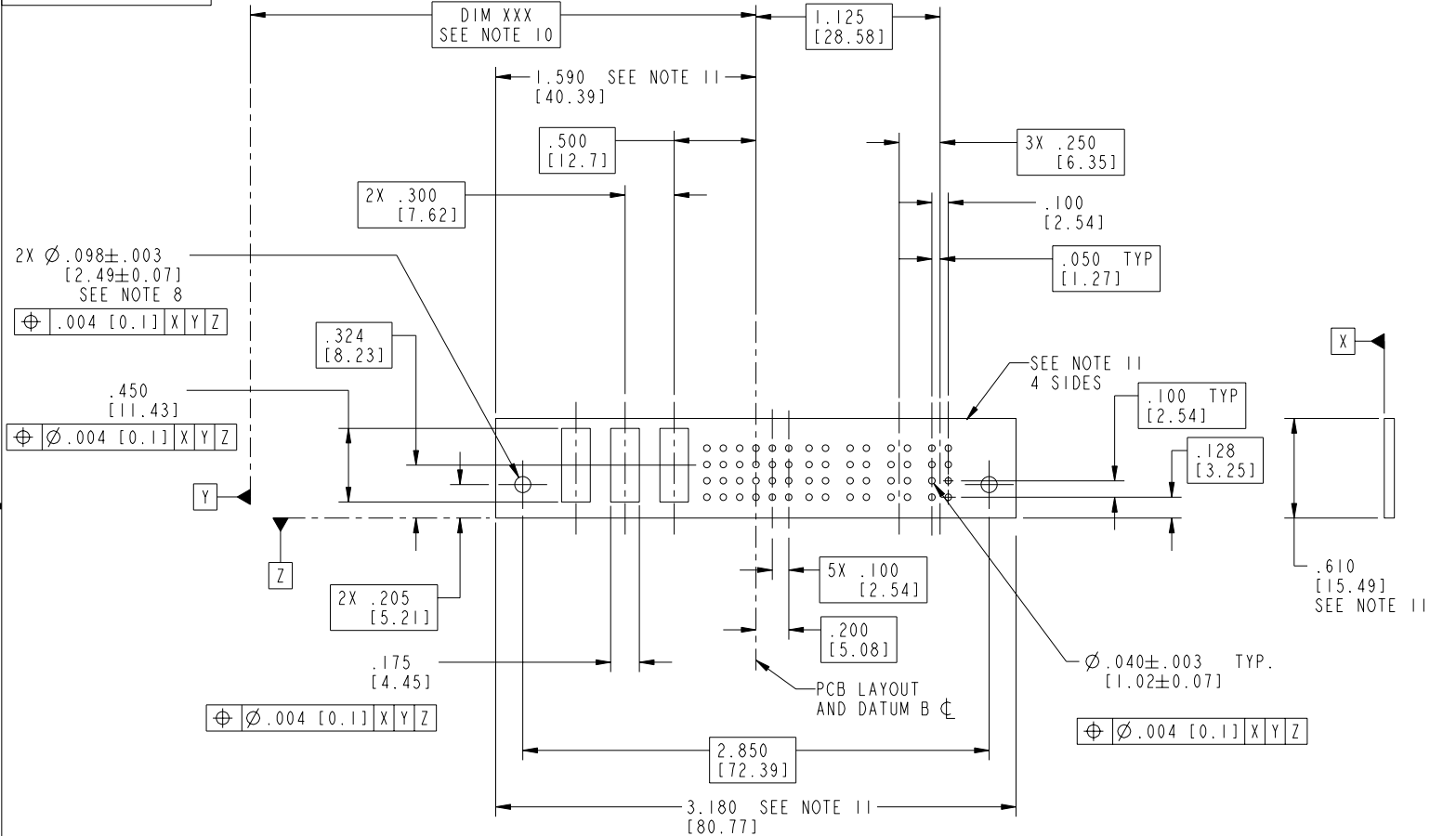

mat'l code				SEE NOTE 2		tolerances unless otherwise specified		CUSTOMER		 www.fciconnect.com	
ltr	ecn no.	dr	date	linear	.XX±.01/0.X±0.3	COPY		projection		title	
B					.XXX±.005/0.XX±0.13					4P + 24S + 3ACP VERTICAL PRESS FIT RECEIPT CABLE PORT	
				angles	.XXX±.0020/0.XX±0.051					product family	
				dr	0° ± 2°			scale		PwrBlade	
				engr	D. INGRAM 03/25/03			size		code	
				chr	M. MOSTOLLER 03/25/03			A		213	
				appd	M. MOSTOLLER 03/25/03			51897-005		sheet	
										3 of 4	
sheet index	revision sheet										

cage code 22526

Pro/E

PDM: Rev:B

STATUS: Released

Printed: Dec 20, 2010

Tous droits strictement réservés. Reproduction ou communication a des tiers interdite sous quelque forme que ce soit sans autorisation écrite du propriétaire. Propriété de c FCI. Droits de reproduction FCI.

A
FCI

All rights strictly reserved. Reproduction or issue to third parties in any form whatever is not permitted without written authority from the proprietor. Property of FCI. Copyright FCI.

B

PRODUCT NUMBER
51897-005_
NOTE: 3

NOTES:
1. DIMENSIONS AND TOLERANCES ARE IN ACCORDANCE WITH ASME Y14.5M, 1994 UNLESS OTHERWISE SPECIFIED.

CONNECTOR NOTES:
② HOUSING MATERIAL: UL 94 V-0 GLASS FILLED
HIGH-TEMP THERMOPLASTIC
POWER CONTACT MATERIAL: COPPER ALLOY
SIGNAL PIN MATERIAL: COPPER ALLOY

3. PLATING:
51897-005 Singal Pin: 30u"/0.76um Au OVER 50u"/1.27um Ni ON THE CONTACT AREA,
AND 100u"/2.54um SnPb PLATING OVER 50u"/1.27um Ni ON THE TERMINATION SECTION.
Power Pin: 30u"/0.76um Au OVER 50u"/1.27um Ni ON THE CONTACT AREA,
AND 100u"/2.54um SnPb PLATING OVER 50u"/1.27um Ni ON THE TERMINATION SECTION.
51897-005LF Singal Pin: 30u"/0.76um Au OVER 50u"/1.27um Ni ON THE CONTACT AREA,
AND 78u"/2.00um Sn PLATING OVER 50u"/1.27um Ni ON THE TERMINATION SECTION.
Power Pin: 30u"/0.76um Au OVER 50u"/1.27um Ni ON THE CONTACT AREA,
AND 78u"/2.00um Sn PLATING OVER 50u"/1.27um Ni ON THE TERMINATION SECTION.

PART NUMBER 51897-005LF MEETS EUROPEAN UNION DIRECTIVE AND OTHER COUNTRY REGULATIONS AS DESCRIBED IN GS-22-008.

THE HOUSING WILL WITHSTAND EXPOSURE TO 260° PEAK TEMPERATURE FOR 10 SECONDS IN A WAVE SOLDER APPLICATION WITH A CIRCUIT BOARD.

④ MANUFACTURER'S NAME, P/N, AND DATE CODE TO APPEAR ON THIS SURFACE.
5. PRODUCT SPECIFICATION GS-12-149.
APPLICATION SPECIFICATION BUS-20-067.
6. PACKAGED IN TRAYS.
PCB NOTES:
7. ALL HOLE DIAMETERS ARE FINISHED HOLE SIZE.
⑧ MOUNTING HOLES, WHERE APPLICABLE, ARE UNPLATED.
⑨ $\varnothing .0453 \pm .0010$ [1.151 ± 0.025] DRILLED HOLES PLATED WITH
.0003 [0.008] MIN SnPb OVER .001 [0.03]
TO .003 [0.08] Cu PLATING TO ACHIEVE
 $\varnothing .040 \pm .003$ [1.02 ± .07] HOLE.

⑩ "DIM XXX" TO BE DETERMINED BY THE CUSTOMER.
⑪ CONNECTOR KEEP-OUT ZONE.

mat'l code				SEE NOTE 2		tolerances unless otherwise specified		CUSTOMER		A FCI		www.fciconnect.com	
ltr	ecn no.	dr	date	linear	.XX±.01/0.X±0.3	COPY		projection		title			
B					.XXX±.005/0.XX±0.13					4P + 24S + 3ACP			
				angles	XXXX±.0020/0.XXX±0.051					VERTICAL PRESS FIT RECEPT CABLE PORT			
				dr	0° ± 2°					product family		code	
				enr	D. INGRAM 03/25/03			INCH/MM		PwrBlade		213	
				chr	M. MOSTOLLER 03/25/03			scale		size		sheet	
				appd	M. MOSTOLLER 03/25/03			1:1		A 51897-005		4 of 4	
sheet index	revision sheet												

cage code 22526 4

1 | 2

3 |

4

1 | 2

Pro/E

3 |

PDM: Rev:B

STATUS: Released

Printed: Dec 20, 2010



Компания «ЭлектроПласт» предлагает заключение долгосрочных отношений при поставках импортных электронных компонентов на взаимовыгодных условиях!

Наши преимущества:

- Оперативные поставки широкого спектра электронных компонентов отечественного и импортного производства напрямую от производителей и с крупнейших мировых складов;
- Поставка более 17-ти миллионов наименований электронных компонентов;
- Поставка сложных, дефицитных, либо снятых с производства позиций;
- Оперативные сроки поставки под заказ (от 5 рабочих дней);
- Экспресс доставка в любую точку России;
- Техническая поддержка проекта, помощь в подборе аналогов, поставка прототипов;
- Система менеджмента качества сертифицирована по Международному стандарту ISO 9001;
- Лицензия ФСБ на осуществление работ с использованием сведений, составляющих государственную тайну;
- Поставка специализированных компонентов (Xilinx, Altera, Analog Devices, Intersil, Interpoint, Microsemi, Aeroflex, Peregrine, Syfer, Eurofarad, Texas Instrument, Miteq, Cobham, E2V, MA-COM, Hittite, Mini-Circuits, General Dynamics и др.);

Помимо этого, одним из направлений компании «ЭлектроПласт» является направление «Источники питания». Мы предлагаем Вам помощь Конструкторского отдела:

- Подбор оптимального решения, техническое обоснование при выборе компонента;
- Подбор аналогов;
- Консультации по применению компонента;
- Поставка образцов и прототипов;
- Техническая поддержка проекта;
- Защита от снятия компонента с производства.



Как с нами связаться

Телефон: 8 (812) 309 58 32 (многоканальный)

Факс: 8 (812) 320-02-42

Электронная почта: org@eplast1.ru

Адрес: 198099, г. Санкт-Петербург, ул. Калинина, дом 2, корпус 4, литера А.