

MPC8XXFADS
Design Specification—Rev 0.1

PRELIMINARY

Freescale Semiconductor, Inc.





How to Reach Us:

Home Page:

www.freescale.com

E-mail:

support@freescale.com

USA/Europe or Locations Not Listed:

Freescale Semiconductor
Technical Information Center, CH370
1300 N. Alma School Road
Chandler, Arizona 85224
+1-800-521-6274 or +1-480-768-2130
support@freescale.com

Europe, Middle East, and Africa:

Freescale Halbleiter Deutschland GmbH
Technical Information Center
Schatzbogen 7
81829 Muenchen, Germany
+44 1296 380 456 (English)
+46 8 52200080 (English)
+49 89 92103 559 (German)
+33 1 69 35 48 48 (French)
support@freescale.com

Japan:

Freescale Semiconductor Japan Ltd.
Headquarters
ARCO Tower 15F
1-8-1, Shimo-Meguro, Meguro-ku,
Tokyo 153-0064
Japan
0120 191014 or +81 3 5437 9125
support.japan@freescale.com

Asia/Pacific:

Freescale Semiconductor Hong Kong Ltd.
Technical Information Center
2 Dai King Street
Tai Po Industrial Estate
Tai Po, N.T., Hong Kong
+800 2666 8080
support.asia@freescale.com

For Literature Requests Only:

Freescale Semiconductor Literature Distribution Center
P.O. Box 5405
Denver, Colorado 80217
1-800-441-2447 or 303-675-2140
Fax: 303-675-2150
LDCForFreescaleSemiconductor@hibbertgroup.com

RoHS-compliant and/or Pb-free versions of Freescale products have the functionality and electrical characteristics of their non-RoHS-compliant and/or non-Pb-free counterparts. For further information, see <http://www.freescale.com> or contact your Freescale sales representative.

For information on Freescale's Environmental Products program, go to <http://www.freescale.com/epp>.

Information in this document is provided solely to enable system and software implementers to use Freescale Semiconductor products. There are no express or implied copyright licenses granted hereunder to design or fabricate any integrated circuits or integrated circuits based on the information in this document. Freescale Semiconductor reserves the right to make changes without further notice to any products herein. Freescale Semiconductor makes no warranty, representation or guarantee regarding the suitability of its products for any particular purpose, nor does Freescale Semiconductor assume any liability arising out of the application or use of any product or circuit, and specifically disclaims any and all liability, including without limitation consequential or incidental damages. "Typical" parameters which may be provided in Freescale Semiconductor data sheets and/or specifications can and do vary in different applications and actual performance may vary over time. All operating parameters, including "Typicals" must be validated for each customer application by customer's technical experts. Freescale Semiconductor does not convey any license under its patent rights nor the rights of others. Freescale Semiconductor products are not designed, intended, or authorized for use as components in systems intended for surgical implant into the body, or other applications intended to support or sustain life, or for any other application in which the failure of the Freescale Semiconductor product could create a situation where personal injury or death may occur. Should Buyer purchase or use Freescale Semiconductor products for any such unintended or unauthorized application, Buyer shall indemnify and hold Freescale Semiconductor and its officers, employees, subsidiaries, affiliates, and distributors harmless against all claims, costs, damages, and expenses, and reasonable attorney fees arising out of, directly or indirectly, any claim of personal injury or death associated with such unintended or unauthorized use, even if such claim alleges that Freescale Semiconductor was negligent regarding the design or manufacture of the part.

1 - General Information

1•1 Introduction

This document is an operation guide for the MPC8XXFADS board. It contains operational, functional and general information about the FADS. The MPC8XXFADS is meant to serve as a platform for s/w and h/w development around the MPC8XX family processors. Using its on-board resources and its associated debugger, a developer is able to download his code, run it, set breakpoints, display memory and registers and connect his own proprietary h/w via the expansion connectors, to be incorporated to a desired system with the MPC8XX processor.

This board could also be used as a demonstration tool, i.e., application s/w may be burned^A into its flash memory and ran in exhibitions etc'.

1•2 MPC8XX Family Support

The MPC8XXFADS supports the following MPC8XX family members:

- MPC801
- MPC821
- MPC823
- MPC850
- MPC860
- MPC860SAR
- MPC860T

1•3 Abbreviations' List

- FADS^B - the MPC8XXFADS, the subject of this document.
- UPM - User Programmable Machine
- GPCM - General Purpose Chip-select Machine
- GPL - General Purpose Line (associated with the UPM)
- I/R - Infra-Red
- BCSR - Board Control & Status Register.
- ZIF - Zero Input Force
- BGA - Ball Grid Array
- SIMM - Single In-line Memory Module

1•4 Related Documentation

- MPC8XX User's Manuals.
- ADI Board Specification.

A. Either on or off-board.

B. Not to be mistaken for the M683XX Family Ads

1.5 SPECIFICATIONS

The MPC8XXFADS specifications are given in [TABLE 1-1](#).

TABLE 1-1. MPC8XXFADS Specifications

<i>CHARACTERISTICS</i>	<i>SPECIFICATIONS</i>
Power requirements (no other boards attached)	+5Vdc @ 1.7 A (typical), 3 A (maximum) +12Vdc - @1A.
Microprocessor	MPC8XX running upto @ 50 MHz
Addressing Total address range:	4 GigaBytes
Flash Memory	2 MByte, 32 bits wide expandable to 8 MBytes
Dynamic RAM	4 MByte, 32 bits wide EDO SIMM Support for up to 32 MByte, EDO or FPM SIMM
Synchronous DRAM	4 MBytes, organized as 1 Meg X 32 bit.
Operating temperature	0°C - 30°C
Storage temperature	-25°C to 85°C
Relative humidity	5% to 90% (non-condensing)
Dimensions:	
Length	9.173" (233 mm)
Width	6.3" (160 mm)
Thickness	0.063" (1.6 mm)

PRELIMINARY

1•6 MPC8XXFADS Features

- ❑ 4 MByte, Unbuffered, Synchronous Dram On-Board.
- ❑ 4 MByte EDO 60nsec delay DRAM SIMM. Support for 4 - 32 MByte FPM or EDO Dram SIMM, with Automatic Dram SIMM identification. 16 Bit Data-Bus Width Support.
- ❑ 2 MByte Flash SIMM. Support for upto 8 MByte, 5V or 12V Programmable, with Automatic Flash SIMM identification.
- ❑ Memory Disable Option for each local memory map slaves.
- ❑ Board Control & Status Register - BCSR, Controlling Board's Operation.
- ❑ Programmable Hard-Reset Configuration via BCSR.
- ❑ 5V **only** PCMCIA Socket With Full Buffering, Power Control and Port Disable Option. Complies with PCMCIA 2.1+ Standard.
- ❑ Module Enable Indications.
- ❑ 10-Base-T Port On-Board, with Stand-By Mode.
- ❑ Fast-IrDA (4MBps) Port with Stand-By Mode.
- ❑ Dual RS232 port with Low-Power Option per each port.
- ❑ On - Board Debug Port Controller with ADI I/F.
- ❑ MPC8XXFADS Serving as Debug Station for Target System option.
- ❑ Optional Hard-Reset Configuration Burned in Flash^A.
- ❑ External Tools' Identification Capability, via BCSR.
- ❑ Soft / Hard^B Reset Push - Button
- ❑ ABORT Push - Button
- ❑ Single^C 5V Supply.
- ❑ Reverse / Over Voltage Protection for Power Inputs.
- ❑ 3.3V / 2V MPC Internal Logic Operation^D, 3.3V MPC I/O Operation.
- ❑ Power Indications for Each Power Bus.
- ❑ Software Option Switch provides 16 S/W options via BCSR.

A. Available only if supported also on the MPC8XX.

B. Hard reset is applied by depressing BOTH Soft Reset & ABORT buttons.

C. Unless a 12V supply is required for a PCMCIA card or for a 12V programmable Flash SIMM.

D. Implemented on Daughter Board.

FIGURE 1-1 MPC8XXFADS Motherboard Block Diagram



1.7 MPC8XXFADS Goals

The MPC8XXFADS is meant to become a general platform for s/w and h/w development around the MPC8XX family. Using its on-board resources and its associated debugger, the developer is able to load his code, run it, set breakpoints, display memory and registers and connect his own proprietary h/w via the expansion connectors, to be incorporated to a system with the MPC.

This board could also be used as a demonstration tool, i.e., application s/w may be programmed^A into its flash memory and ran in exhibitions etc.

A. Either on or off-board.

2 - Hardware Preparation and Installation

2•1 INTRODUCTION

This chapter provides unpacking instructions, hardware preparation, and installation instructions for the MPC8XXFADS.

2•2 UNPACKING INSTRUCTIONS

NOTE

If the shipping carton is damaged upon receipt, request carrier's agent to be present during unpacking and inspection of equipment.

Unpack equipment from shipping carton. Refer to packing list and verify that all items are present. Save packing material for storing and reshipping of equipment.

CAUTION

AVOID TOUCHING AREAS OF INTEGRATED CIRCUITRY; STATIC DISCHARGE CAN DAMAGE CIRCUITS.

2•3 HARDWARE PREPARATION

To select the desired configuration and ensure proper operation of the MPC8XXFADS board, changes of the Dip-Switch settings may be required before installation. The location of the switches, LEDs, Dip-Switches, and connectors is illustrated in [FIGURE 2-1](#). The board has been factory tested and is shipped with Dip-Switch settings as described in the following paragraphs. Parameters can be changed for the following conditions:

- ADI port address
- MPC Clock Source
- Power-On Reset Source.
- MPC Keep Alive Power Source
- MPC Internal Logic Supply Source
- Debug Mode Indication Source

FIGURE 2-1 MPC8XXFADS Top Side Part Location diagram



Freescale Semiconductor, Inc.

2•3•1 ADI Port Address Selection

The MPC8XXFADS can have eight possible slave addresses set for its ADI port, enabling up to eight MPC8XXFADS boards to be connected to the same ADI board in the host computer. The selection of the slave address is done by setting switches 1, 2 & 3 in the Dip-Switch - DS2. Switch 1 stands for the most-significant bit of the address and switch 3 stands for the least-significant bit. If the switch is in the 'ON' state, it stands for logical '1'. In [FIGURE 2-2](#) DS1 is shown to be configured to address '0'.

FIGURE 2-2 Configuration Dip-Switch - DS2



[Table 2-1](#) describes the switch settings for each slave address:

Table 2-1 ADI Address Selection

ADDRESS	Switch 1	Switch 2	Switch 3
0	OFF	OFF	OFF
1	OFF	OFF	ON
2	OFF	ON	OFF
3	OFF	ON	ON
4	ON	OFF	OFF
5	ON	OFF	ON
6	ON	ON	OFF
7	ON	ON	ON

2•3•2 Clock Source Selection

Switch #4 on DS2 selects the clock source for the MPC. When it is in the 'ON' position while the FADS is powered-up, the on-board 32.768 KHz crystal resonator^A becomes the clock source and the PLL multiplication factor becomes 1:513. When switch #4 is in the 'OFF' position while the FADS is powered-up, the on-board 4^BMHz clock generator^A becomes the clock source while the PLL multiplication factor becomes 1:5.

2•3•3 Power-On Reset Source Selection

As there are differences between MPC revisions regarding the functionality of the Power-On Reset logic, it is therefore necessary to select different sources for Power-ON reset generation.

The above selection is done on the Daughter Board and therefore, documented in the specific

A. Located on the Daughter-Board

B. A 5MHz clock generator is packed as well.

Daughter Board user's manual.

2•3•4 VDDL Source Selection

This selection is done on the Daughter Board and therefore, documented in the specific Daughter Board user's manual.

2•3•5 Keep Alive Power Source Selection

This selection is done on the Daughter Board and therefore, documented in the specific Daughter Board user's manual.

2•3•6 Debug Mode Indication Source Selection

Jumper J1 selects between VFLS(0:1) signals and FRZ signal of the MPC as an indication for debug mode state. Since with the MPC8XXs, each of these signals has alternate function, it may be necessary to switch between the two sources, in favor of alternate function being used.

When a jumper is positioned between pins 1 and 2 of J1 - VFLS(0:1) are selected towards the debug-port controller. When a jumper is placed between positions 2 - 3 of J1(2) - FRZ signal is selected.

FIGURE 2-3



2•4 INSTALLATION INSTRUCTIONS

When the MPC8XXFADS has been configured as desired by the user, it can be installed according to the required working environment as follows:

- Host Controlled Operation
- Debug Port Controller for Target System
- Stand-Alone

2•4•1 Host Controlled Operation

In this configuration the MPC8XXFADS is controlled by a host computer via the ADI through the debug port. This configuration allows for extensive debugging using on-host debugger.

FIGURE 2-4 Host Controlled Operation Scheme



2•4•2 Debug Port Controller For Target System

This configuration resembles the previous, but here the local MPC is removed from its socket while the FADS is connected via a 10 lead Flat-Cable between P5 and a matching connector on a target system.

WARNING

When connecting the FADS to a target system via P5 and a 10 lead flat-cable, the MPC MUST be REMOVED from its SOCKET. Otherwise, PERMANENT DAMAGE might be inflicted to either the Local MPC or to the Target MPC.

With this mode of operation, all on-board modules are disabled and can not be accessed in anyway, except for the debug port controller. Also, all indications except for 5V power, 3.3V-Power^A and RUN are darkened.

All debugger commands and debugging features are available in this mode, including s/w download, breakpoints, etc'... The target system may be reset or interrupted by the debug port or reset by the FADS's RESET switches. It is the responsibility of the target system designer, to provide Power-On-Reset and HARD-Reset configurations, while SOFT-Reset configuration is provided by the debug-port controller. See also 4•12•1 "MPC8XXFADS As Debug Port Controller For Target System" on page 58.

A. On Daughter Board.

FIGURE 2-5 Debug Port Controller For Target System Operation Scheme

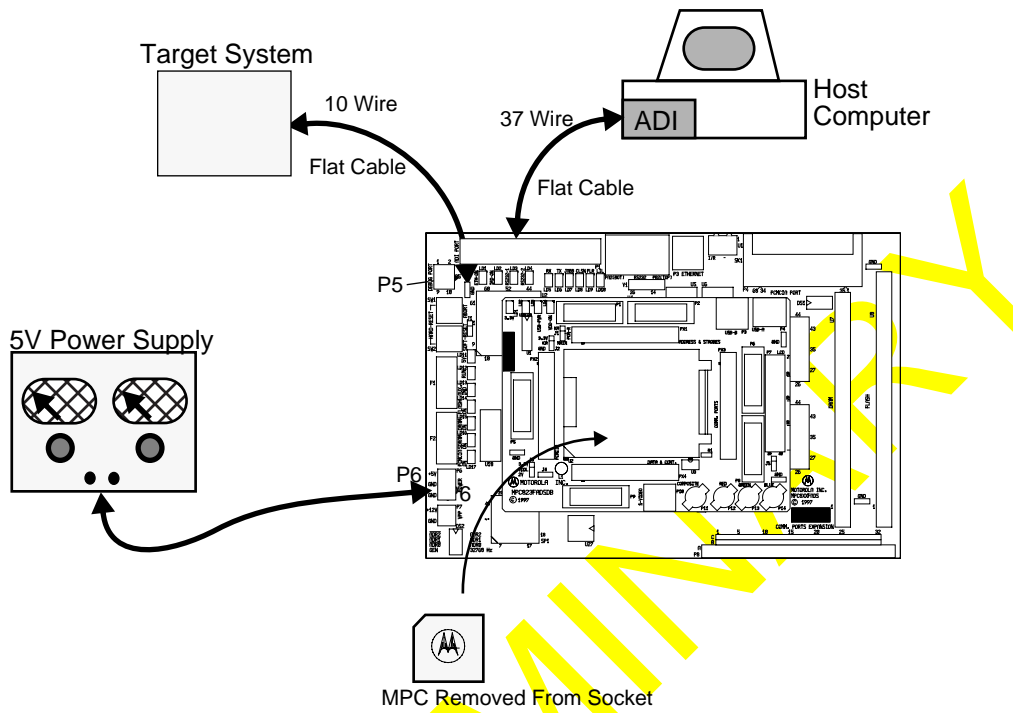

2•4•3 Stand Alone Operation

In this mode, the FADS is not controlled by the host via the ADI/Debug port. It may connect to host via one of its other ports, e.g., RS232 port, I/R port, Ethernet port, etc'. Operating in this mode requires an application program to be programmed into the board's Flash memory (while with the host controlled operation, no memory is required at all).

FIGURE 2-6 Stand Alone Configuration



2•4•4 +5V Power Supply Connection

The MPC8XXFADS requires +5 Vdc @ 5 A max, power supply for operation. Connect the +5V power supply to connector P6 as shown below:

FIGURE 2-7 P6: +5V Power Connector



P6 is a 3 terminal block power connector with power plug. The plug is designed to accept 14 to 22 AWG wires. It is recommended to use 14 to 18 AWG wires. To provide solid ground, two Gnd terminals are supplied. It is recommended to connect both Gnd wires to the common of the power supply, while VCC is connected with a single wire.

NOTE

Since hardware applications may be connected to the MPC8XXFADS via the Daughter-Boards' expansion connectors PX1, PX2, PX3, PX4 or FADS's P8, the additional power consumption should be taken into consideration when a power supply is connected to the MPC8XXFADS.

2•4•5 P7: +12V Power Supply Connection

The MPC8XXFADS requires +12 Vdc @ 1 A max, power supply for the PCMCIA channel Flash programming capability or for 12V programmable Flash SIMM. The MPC8XXFADS can work properly without the +12V power supply, if there is no need to program either a 12V programmable PCMCIA flash card or a 12V programmable Flash SIMM.

Connect the +12V power supply to connector P7 as shown below:

FIGURE 2-8 P7: +12V Power Connector



P7 is a 2 terminal block power connector with power plug. The plug is designed to accept 14 to 22 AWG wires. It is recommended to use 14 to 18 AWG wires.

2•4•6 ADI Installation

For ADI installation on various host computers, refer to [APPENDIX C - "ADI Installation" on page 155](#).

2•4•7 Host computer to MPC8XXFADS Connection

The MPC8XXFADS ADI interface connector, P1, is a 37 pin, male, D type connector. The connection between the MPC8XXFADS and the host computer is by a 37 line flat cable, supplied with the ADI board. [FIGURE 2-9](#) below shows the pin configuration of the connector.

FIGURE 2-9 P1 - ADI Port Connector

Gnd	20	1	N.C
Gnd	21	2	D_C~
Gnd	22	3	HST_ACK
Gnd	23	4	ADS_SRESET
Gnd	24	5	ADS_HRESET
Gnd	25	6	ADS_SEL2
Gnd	26	7	ADS_SEL1
(+ 12 v) N.C.	27	8	ADS_SEL0
HOST_VCC	28	9	HOST_REQ
HOST_VCC	29	10	ADS_REQ
HOST_VCC	30	11	ADS_ACK
HOST_ENABLE~	31	12	N.C.
Gnd	32	13	N.C.
Gnd	33	14	N.C.
Gnd	34	15	N.C.
PD0	35	16	PD1
PD2	36	17	PD3
PD4	37	18	PD5
PD6		19	PD7

NOTE: Pin 26 on the ADI is connected to +12 v power supply, but it is not used in the MPC8XXFADS.

2•4•8 Terminal to MPC8XXFADS RS-232 Connection

A serial (RS232) terminal or any other RS232 equipment, may be connected to the RS-232 connectors PA2 and PB2. The RS-232 connectors is a 9 pin, female, Stacked D-type connector as shown in [FIGURE 2-10](#).

The connectors are arranged in a manner that allows for 1:1 connection with the serial port of an IBM-AT^A or compatibles, i.e. via a flat cable.

A. IBM-AT is a trademark of International Business Machines Inc.

FIGURE 2-10 PA2, PB2 - RS-232 Serial Port Connectors

CD	1	6	DSR
TX	2	7	RTS
RX	3	8	CTS
DTR	4	9	N.C.
GND	5		

NOTE: The RTS line (pin 7) is not connected on the MPC8XXFADS.

2•4•9 Memory Installation

The MPC8XXFADS is supplied with two types of memory SIMM:

- Dynamic Memory SIMM
- Flash Memory SIMM.

To avoid shipment damage, these memories are packed aside rather than being installed in their sockets. Therefore, they should be installed on site. To install a memory SIMM, it should be taken out of its package, put diagonally in its socket (no error can be made here, since the Flash socket has 80 contacts, while the DRAM socket has 72) and then twisted to a vertical position until the metal lock clips are locked. See [FIGURE 2-11 "Memory SIMM Installation"](#) below.

CAUTION

The memory SIMMs have alignment nibble near their # 1 pin. It is important to align the memory correctly before it is twisted, otherwise damage might be inflicted to both the memory SIMM and its socket.

FIGURE 2-11 Memory SIMM Installation

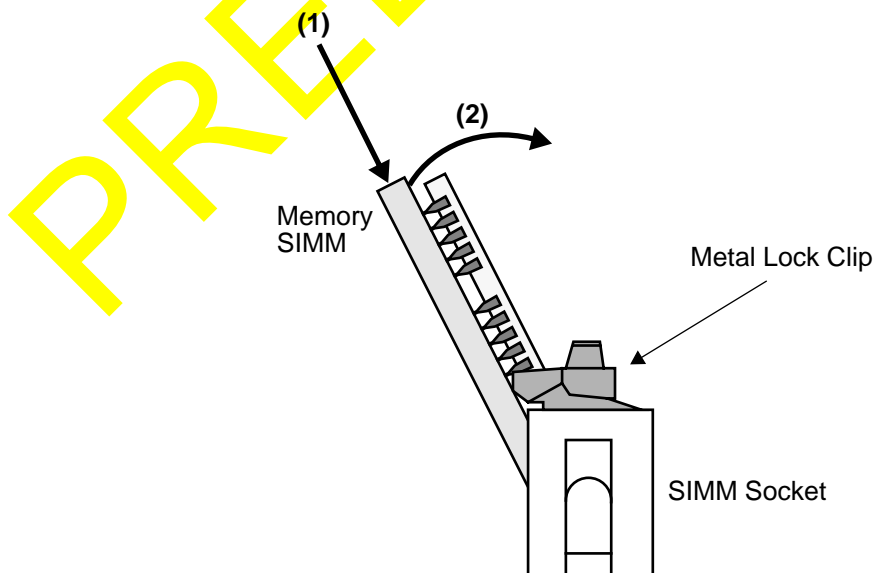

3 - OPERATING INSTRUCTIONS

3•1 INTRODUCTION

This chapter provides necessary information to use the MPC8XXFADS in host-controlled and stand-alone configurations. This includes controls and indicators, memory map details, and software initialization of the board.

3•2 CONTROLS AND INDICATORS

The MPC8XXFADS has the following switches and indicators.

3•2•1 ABORT Switch SW1

The ABORT switch is normally used to abort program execution, this by issuing a level 0 interrupt to the MPC. If the FADS is in stand alone mode, it is the responsibility of the user to provide means of handling the interrupt, since there is no resident debugger with the MPC8XXFADS. The ABORT switch signal is debounced, and can not be disabled by software.

3•2•2 SOFT RESET Switch SW2

The SOFT RESET switch SW2 performs Soft reset to the MPC internal modules, maintaining MPC's configuration (clocks & chip-selects) Dram and SDram contents. The switch signal is debounced, and it is not possible to disable it by software. At the end of the Soft Reset Sequence, the Soft Reset Configuration is sampled and becomes valid.

3•2•3 HARD RESET - Switches SW1 & SW2

When BOTH switches - SW1 and SW2 are depressed simultaneously, HARD reset is generated to the MPC. When the MPC is HARD reset, all its configuration is lost, including data stored in the DRAM or SDRAM and the MPC has to be re-initialized. At the end of the Hard Reset sequence, the Hard Reset Configuration stored in BCSR0 becomes valid.

3•2•4 DS1 - Software Options Switch

DS1 is a 4-switches Dip-Switch. This switch is connected over EXTOLI(0:3) lines which are available at BCSR, S/W options may be manually selected, according to DS1 state.

FIGURE 3-1 DS1 - Description



3•2•5 GND Bridges

There are 3 GND bridges on the MPC8XXFADS. They are meant to assist general measurements

and logic-analyzer connection.

Warning

When connecting to a GND bridge, use only INSULATED GND clips. Failure in doing so, might result in permanent damage to the MPC8XXFADS.

3•2•6 ETH ON - LD1

When the yellow ETH ON led is lit, it indicates that the ethernet port transceiver - the MC68160 EEST, is active. When it is dark, it indicates that the EEST is in power down mode, enabling the use of its associated SCC pins off-board via the expansion connectors.

3•2•7 IRD ON - LD2

When the yellow IRD ON led is lit, it indicates that the Infra-Red transceiver - the TFDS6000, is active and enables communication via that medium. When it is dark, the I/R transceiver is in shutdown mode, enabling the use of its associated SCC pins off-board via the expansion connectors.

3•2•8 RS232 Port 1 ON - LD3

When the yellow RS232 Port 1 ON led is lit, it designates, that the RS232 transceiver connected to PA2, is active and communication via that medium is allowed. When darkened, it designates that the transceiver is in shutdown mode, so its associated MPC pins may be used off-board via the expansion connectors.

3•2•9 RS232 Port 2 ON - LD4

When the yellow RS232 Port 2 ON led is lit, it designates that the RS232 transceiver connected to PB2, is active and communication via that medium is allowed. When darkened, it designates, that the transceiver is in shutdown mode, so its associated MPC pins may be used off-board via the expansion connectors.

3•2•10 Ethernet RX Indicator - LD5

The green Ethernet Receive LED indicator blinks whenever the EEST is receiving data from one of the Ethernet port.

3•2•11 Ethernet TX Indicator - LD6

The green Ethernet Receive LED indicator blinks whenever the EEST is transmitting data via the Ethernet port.

3•2•12 Ethernet JABB Indicator - LD7

The red Ethernet TP Jabber LED indicator - JABB, lights whenever a jabber condition is detected on the TP ethernet port.

3•2•13 Ethernet CLSN Indicator LD8

The red Ethernet Collision LED indicator CLSN, blinks whenever a collision condition is detected on the ethernet port, i.e., simultaneous receive and transmit.

3•2•14 Ethernet PLR Indicator - LD9

The red Ethernet TP Polarity LED indicator - PLR, lights whenever the wires connected to the receiver input of the ethernet port are reversed. The LED is lit by the EEST, and remains on while the EEST has automatically corrected for the reversed wires.

3•2•15 Ethernet LIL Indicator - LD10

The yellow Ethernet Twisted Pair Link Integrity LED indicator - LIL, lights to indicate good link integrity on the TP port. The LED is off when the link integrity fails.

3•2•16 5V Indicator - LD11

The yellow 5V led, indicates the presence of the +5V supply at P6.

3•2•17 RUN Indicator - LD12

When the green RUN led - LD12 is lit, it indicates that the MPC is not in debug mode, i.e., VFLS0 & VFLS1 == 0 (or FRZ == 0, which ever selected by J1).

3•2•18 AUXILARY Indicator LD13

This indication has no dedicated function over the FADS. It is meant to provide some visibility for program behavior. It is controlled by the Signal Lamp bit in BCSR4.

3•2•19 FLASH ON - LD14

When the yellow FLASH ON led is lit, it indicates that the FLASH SIMM is enabled in the BCSR1 register. I.e., any access done to the CS0~ address space will hit the flash memory. When it is dark, the flash is disabled and CS0~ may be used off-board via the expansion connectors.

3•2•20 DRAM ON - LD15

When the yellow DRAM ON led is lit, it indicates the DRAM SIMM is enabled in BCSR1. Therefore, any access made to CS2~ (or CS3~) will hit on the DRAM. When it is dark, it indicates that either the DRAM is disabled in BCSR1, enabling the use of CS2~ and CS3~ off-board via the expansion connectors.

3•2•21 SDRAM ON - LD16

When the yellow SDRAM ON led is lit, it indicates the SDRAM is enabled in BCSR1. Therefore, any access made to CS4~ (will hit on the SDRAM. When it is dark, it indicates that either the SDRAM is disabled in BCSR1, enabling the use of CS4~ off-board via the expansion connectors.

3•2•22 PCMCIA ON - LD17

When the yellow PCMCIA ON led is lit, it indicates the following:

- 1) Address & strobe buffers are driven towards the PCMCIA card
- 2) Data buffers are driven to / from the PCMCIA card whenever CE1A~^A or CE2A~^B signals are asserted.
- 3) Card status lines are driven towards the MPC from the PCMCIA card.

When it is dark, it indicates that all the above buffers are tri-stated and the pins associated with PCMCIA channel A^C, may be used off-board via the expansion connectors.

3•3 MEMORY MAP

All accesses to MPC8XXFADS's memories are controlled by the MPC's memory controller. Therefore, the memory map is reprogrammable to the desire of the user. After Hard Reset is performed by the debug station, the debugger checks to see the size, delay and type of the DRAM and FLASH SIMMs mounted on board and initializes the chip-selects accordingly. The DRAM,

A. Connected to CE1B~ for MPC823FADSDB.

B. Connected to CE2B~ for MPC823FADSDB.

C. Or B for MPC823FADSDB.

SDRAM and the FLASH memory respond to all types of memory access i.e., user / supervisory, program / data and DMA.

TABLE 3-1. MPC8XXADS Main Memory Map

ADDRESS RANGE	Memory Type	Device Type				Port Size
		MB321Bx ^a 08	MB322Bx ^a 08	MC324Cx ^a 00	MB328Cx ^a 00	
00000000 - 003FFFFFFF	DRAM SIMM					32
00400000 - 007FFFFFFF						32
00800000 - 00FFFFFFF						32
01000000 - 01FFFFFFF						32
02000000 - 020FFFFFFF	Empty Space					
02100000 - 02103FFF	BCSR(0:4) ^b					32 ^c
02100000 - 02103FE3	BCSR0					
2100004 - 02103FE7	BCSR1					
2100008 - 02103FEB	BCSR2					
210000C - 02103FEF	BCSR3					
2100010 - 02103FF3	BCSR4					
02104000 - 021FFFFFFF	Empty Space					
02200000 - 02207FFF	MPC Internal MAP ^d					32
02208000 - 027FFFFFFF	Empty Space					
02800000 - 029FFFFFFF	Flash SIMM	MCM29F020	MCM29F040 SM732A1000A	MCM29F080 SM732A2000		32
02A00000 - 02BFFFFFFF						32
02C00000 - 02FFFFFFF						32
03000000 - 033FFFFFFF	SDRAM					32
03400000 - FFFFFFFF	Empty Space					

a. $x \in [B,T]$

b. The device appears repeatedly in multiples of its size. E.g., BCSR0 appears at memory locations 2100000, 2100020, 2100040..., while BCSR1 appears at 2100004, 2100024, 2100044... and so on.

c. Only upper 16 bit (D0-D15) are in fact used.

d. Refer to the relevant MPC User's Manual for complete description of the MPC internal memory map.

3•4 Programming The MPC Registers

The MPC provides the following functions on the MPC8XXFADS:

- 1) DRAM Controller
- 2) SDRAM Controller
- 3) Chip Select generator.
- 4) UART for terminal or host computer connection.

- 5) Ethernet controller.
- 6) Infra-Red Port Controller
- 7) General Purpose I/O signals.

The internal registers of the MPC must be programmed after Hard reset as described in the following paragraphs. The addresses and programming values are in hexadecimal base.

For better understanding the of the following initializations refer to the MPC821 or to the MPC860 User's Manual for more information.

TABLE 3-2. SIU REGISTERS' PROGRAMMING

<i>Register</i>	<i>Init Value[hex]</i>	<i>Description</i>
SIUMCR	01032440	Internal arbitration, External master arbitration priority - 0, External arbitration priority - 0, PCMCIA channel II pins - PCMCIA, Debug Port on JTAG port pins, FRZ/IRQ6~ - FRZ, debug register - locked, No parity for non-CS regions, DP(0:3)/IRQ(3:6)~ pins - DP(0:3), reservation disabled, SPKROUT - Tri-stated, BS_A(0:3)~ and WE(0:3)~ are driven just on their dedicated pins, GPL_B5~ enabled, GPL_A/B(2:3)~ function as GPLs.
SYPCR	FFFFFF88	Software watchdog timer count - FFFF, Bus-monitor timing FF, Bus-monitor - Enabled, S/W watch-dog - Freeze, S/W watch-dog - disabled, S/W watch-dog (if enabled) causes NMI, S/W (if enabled) not prescaled.
TBSCR	00C2	No interrupt level, reference match indications cleared, interrupts disabled, no freeze, time-base disabled.
RTCSC	00C2	Interrupt request level - 0, 32768 Hz source, second interrupt disabled, Alarm interrupt disabled, Real-time clock - FREEZE, Real-time clock enabled.
PISCR	0082	No level for interrupt request, Periodic interrupt disabled, clear status, interrupt disabled, FREEZE, periodic timer disabled.

3•4•1 Memory Controller Registers Programming

The memory controller on the MPC8XXFADS is initialized to 50 MHz operation. I.e., registers' programming is based on 50 MHz timing calculation except for refresh timer which is initialized to 16.67Mhz, the lowest frequency at which the FADS may wake up. Since the FADS may be made to wake-up at 25MHz^A as well, the initializations are not efficient, since there are too many wait-states inserted. Therefore, additional set of initialization is provided to support efficient 25MHz operation.

The reason for initializing the FADS for 50Mhz is to allow proper (although not efficient) FADS operation through all available FADS clock frequencies.

A. The only parameter which is initialized to the start-up frequency, is the refresh rate, which would have been inadequate if initialized to 50Mhz while board is running at a lower frequency. Therefore, for best bus bandwidth availability, refresh rate should be adapted to the current system clock frequency.

Warning

Due to availability problems with few of the supported memory components, the below initializations were not tested with all parts. Therefore, the below initializations are liable to CHANGE, throughout the testing period.

TABLE 3-3. Memory Controller Initializations For 50Mhz

<i>Register</i>	<i>Device Type</i>	<i>Init Value [hex]</i>	<i>Description</i>
BR0	All Flash SIMMs supported.	02200001	Base at 2200000, 32 bit port size, no parity, GPCM
OR0	MCM29F020-90	FFE00D34	2MByte block size, all types access, CS early negate, 6 w.s., Timing relax
	MCM29F040-90 SM732A1000A-9	FFC00D34	4MByte block size, all types access, CS early negate, 6 w.s., Timing relax
	MCM29F080-90 SM732A2000-9	FF800D34	8MByte block size, all types access, CS early negate, 6 w.s., Timing relax
	MCM29F020-12	FFE00D44	2MByte block size, all types access, CS early negate, 8 w.s., Timing relax
	MCM29F040-12 SM732A1000A-12	FFC00D44	4MByte block size, all types access, CS early negate, 8 w.s., Timing relax
	MCM29F080-12 SM732A2000-12	FF800D44	8MByte block size, all types access, CS early negate, 8 w.s., Timing relax
BR1	BCSR	02100001	Base at 2100000, 32 bit port size, no parity, GPCM
OR1		FFFF8110	32 KByte block size, all types access, CS early negate, 1 w.s.
BR2	All Dram Supported SIMMs	00000081	Base at 0, 32 bit port size, no parity, UPMA
OR2	MCM36100/200-60/70	FFC00800	4MByte block size, all types access, initial address multiplexing according to AMA.
	MCM36400/800-60/70 MT8/16D432/832X-6/7	FF000800	16MByte block size, all types access, initial address multiplexing according to AMA.
BR3	MCM36200-60/70	00400081	Base at 400000, 32 bit port size, no parity, UPMA
	MCM36800-60/70 MT16D832X-6/7	01000081	Base at 1000000, 32 bit port size, no parity, UPMA
OR3	MCM36200-60/70	FFC00800	4MByte block size, all types access, initial address multiplexing according to AMA
	MCM36800-60/70 MT16D832X-6/7	FF000800	16MByte block size, all types access, initial address multiplexing according to AMA.
BR4	MB811171622A-100	030000C1	Base at 3000000, on UPM B
OR4		FFC00A00	4 MByte block size, all types access, initial address multiplexing according to AMB.

Freescale Semiconductor, Inc.

TABLE 3-3. Memory Controller Initializations For 50Mhz

Register	Device Type	Init Value [hex]	Description
MPTPR	All Dram SIMMs Supported	0400	Divide by 16 (decimal)
MAMR	MB321BT08TASN60	40A21114 ^a 60A21114 ^b C0A21114 ^c	refresh clock divided by 40 ^a or 60 ^b or C0 ^c , periodic timer enabled, type 2 address multiplexing scheme, 1 cycle disable timer, GPL4 disabled for data sampling edge flexibility, 1 loop read, 1 loop write, 4 beats refresh burst.
	MB322BT08TASN60	20A21114 ^a 30A21114 ^b 60A21114 ^c	refresh clock divided by 20 ^a or 30 ^b or 60 ^c , periodic timer enabled, type 2 address multiplexing scheme, 1 cycle disable timer, GPL4 disabled for data sampling edge flexibility, 1 loop read, 1 loop write, 4 beats refresh burst.
	MB324CT00TBSN60	40B21114 ^a 60B21114 ^b C0B21114 ^c	refresh clock divided by 40 ^a or 60 ^b or C0 ^c , periodic timer enabled, type 3 address multiplexing scheme, 1 cycle disable timer, GPL4 disabled for data sampling edge flexibility, 1 loop read, 1 loop write, 4 beats refresh burst.
	MB328CT00TBSN60	20B21114 ^a 30B21114 ^b 60B21114 ^c	refresh clock divided by 20 ^a or 30 ^b or 60 ^c , periodic timer enabled, type 3 address multiplexing scheme, 1 cycle disable timer, GPL4 disabled for data sampling edge flexibility, 1 loop read, 1 loop write, 4 beats refresh burst.
MBMR	MB811171622A-100	D0802114 ^c 80802114 ^d	refresh clock divided by D0 or 80, periodic timer enabled, type 0 address multiplexing scheme, 1 cycle disable timer, GPL4 enabled, 1 loop read, 1 loop write, 4 beats refresh burst.

- a. Assuming 16.67 MHz BRGCLK.
- b. Assuming 25MHz BRGCLK
- c. For 50MHz BRGCLK
- d. Assuming 32MHz BRGCLK.

Freescale Semiconductor, Inc.

TABLE 3-4. UPMA Initializations for 60nsec DRAMs @ 50MHz

Cycle Type		Single Read	Burst Read	Single Write	Burst Write	Refresh	Exception
Offset in UPM		0	8	18	20	30	3C
Contents @ Offset +	0	8FFFECC24	8FFFECC24	8FAFCC24	8FAFCC24	C0FFCC84	33FFCC07
	1	0FFFECC04	0FFFECC04	0FAFCC04	0FAFCC04	00FFCC04	X
	2	0CFFFECC04	08FFFECC04	0CAFCC00	0CAFCC00	07FFCC04	X
	3	00FFFECC04	00FFFECC0C	11BFCC47	03AFCC4C	3FFFCC06	X
	4	00FFFECC00	03FFFECC00	X	0CAFCC00	FFFFCC85	
	5	37FFFECC47	00FFFECC44	X	03AFCC4C	FFFFCC05	
	6	X	00FFCC08	X	0CAFCC00	X	
	7	X	0CFFCC44	X	03AFCC4C	X	
	8		00FFFECC0C		0CAFCC00	X	
	9		03FFFECC00		33BFCC4F	X	
	A		00FFFECC44		X	X	
	B		00FFCC00		X	X	
	C		3FFFCC847		X		
	D		X		X		
	E		X		X		
	F		X		X		

PRELIMINARY

TABLE 3-5. UPMA Initializations for 60nsec EDO DRAMs @ 50MHz

Cycle Type		Single Read	Burst Read	Single Write	Burst Write	Refresh	Exception
Offset in UPM		0	8	18	20	30	3C
Contents @ Offset +	0	8FFBEC24	8FFFEC24	8FFFCC24	8FFFCC24	C0FFCC84	33FFCC07
	1	0FF3EC04	0FFBEC04	0FEFCC04	0FEFCC04	00FFCC04	X
	2	0CF3EC04	0CF3EC04	0CAFCC00	0CAFCC00	07FFCC04	X
	3	00F3EC04	00F3EC0C	11BFCC47	03AFCC4C	3FFFCC06	X
	4	00F3EC00	0CF3EC00	X	0CAFCC00	FFFFCC85	
	5	37F7EC47	00F3EC4C	X	03AFCC4C	FFFFCC05	
	6	X	0CF3EC00	X	0CAFCC00	X	
	7	X	00F3EC4C	X	03AFCC4C	X	
	8		0CF3EC00		0CAFCC00	X	
	9		00F3EC44		33BFCC4F	X	
	A		03F3EC00		X	X	
	B		3FF7EC47		X	X	
	C		X		X		
	D		X		X		
	E		X		X		
	F		X		X		

TABLE 3-6. Memory Controller Initializations For 20Mhz

Register	Device Type	Init Value [hex]	Description
BR0	All Flash SIMMs supported.	02200001	Base at 2200000, 32 bit port size, no parity, GPCM

Freescale Semiconductor, Inc.

TABLE 3-6. Memory Controller Initializations For 20Mhz

<i>Register</i>	<i>Device Type</i>	<i>Init Value [hex]</i>	<i>Description</i>
OR0	MCM29F020-90	FFE00D20	2MByte block size, all types access, CS early negate, 2 w.s.
	MCM29F040-90 SM732A1000A-9	FFC00D20	4MByte block size, all types access, CS early negate, 2 w.s.
	MCM29F080-90 SM732A2000-9	FF800920	8MByte block size, all types access, CS early negate, 2 w.s., Timing relax
	MCM29F020-12	FFE00D30	2MByte block size, all types access, CS early negate, 3 w.s.
	MCM29F040-12 SM732A1000A-12	FFC00D30	4MByte block size, all types access, CS early negate, 3 w.s.
	MCM29F080-12 SM732A2000-12	FF800930	8MByte block size, all types access, CS early negate, 3 w.s.
BR1	BCSR	02100001	Base at 2100000, 32 bit port size, no parity, GPCM
OR1		FFFF8110	32 KByte block size, all types access, CS early negate, 1 w.s.
BR2	All Dram SIMMs Supported	00000081	Base at 0, 32 bit port size, no parity, UPMA
OR2	MB321/2BT08TASN60	FFC00800	4MByte block size, all types access, initial address multiplexing according to AMA.
	MB324/8CT00TBSN60	FF000800	16MByte block size, all types access, initial address multiplexing according to AMA.
BR3 ^a	MB322BT08TASN60	00400081	Base at 400000, 32 bit port size, no parity, UPMA
	MB328CT00TBSN60	01000081	Base at 1000000, 32 bit port size, no parity, UPMA
OR3	MB322BT08TASN60	FFC00800	4MByte block size, all types access, initial address multiplexing according to AMA
	MB328CT00TBSN60	FF000800	16MByte block size, all types access, initial address multiplexing according to AMA.
BR4	MB811171622A-100	030000C1	Base at 3000000, on UPM B.
OR4		FFC00A00	4MByte block size, all types access, initial address multiplexing according to AMB
MPTPR	All Dram SIMMs Supported	0400	Divide by 16 (decimal)

TABLE 3-6. Memory Controller Initializations For 20Mhz

<i>Register</i>	<i>Device Type</i>	<i>Init Value [hex]</i>	<i>Description</i>
MAMR	MB321BT08TASN60	60A21114	refresh clock divided by 60, periodic timer enabled, type 2 address multiplexing scheme, 1 cycle disable timer, GPL4 disabled for data sampling edge flexibility, 1 loop read, 1 loop write, 4 beats refresh burst.
	MB322BT08TASN60	30A21114	refresh clock divided by 30, periodic timer enabled, type 2 address multiplexing scheme, 1 cycle disable timer, GPL4 disabled for data sampling edge flexibility, 1 loop read, 1 loop write, 4 beats refresh burst.
	MB324CT00TBSN60	60B21114	refresh clock divided by 60, periodic timer enabled, type 3 address multiplexing scheme, 1 cycle disable timer, GPL4 disabled for data sampling edge flexibility, 1 loop read, 1 loop write, 4 beats refresh burst.
	MB328CT00TBSN60	30B21114	refresh clock divided by 30, periodic timer enabled, type 3 address multiplexing scheme, 1 cycle disable timer, GPL4 disabled for data sampling edge flexibility, 1 loop read, 1 loop write, 4 beats refresh burst.
MBMR	MB811171622A-100	42802114 ^b	refresh clock divided by 42, periodic timer enabled, type 0 address multiplexing scheme, 1 cycle disable timer, GPL4 enabled, 1 loop read, 1 loop write, 4 beats refresh burst.

a. BR3 is not initialized for MB321xx or MB324xx EDO DRAM SIMMs.

b. Assuming 16.67MHz BRGCLK

PRELIMINARY

TABLE 3-7. UPMA Initializations for 60nsec EDO DRAMs @ 20MHz

Cycle Type		Single Read	Burst Read	Single Write	Burst Write	Refresh	Exception
Offset in UPM		0	8	18	20	30	3C
Contents @ Offset +	0	8FFFCC04	8FFFCC04	8FEFCC00	8FEFCC00	80FFCC84	33FFCC07
	1	08FFCC00	08FFCC08	39BFCC47	09AFCC48	17FFCC04	X
	2	33FFCC47	08FFCC08	X	09AFCC48	FFFFCC86	X
	3	X	08FFCC08	X	09AFCC48	FFFFCC05	X
	4	X	08FFCC00	X	39BFCC47	X	
	5	X	3FFFCC47	X	X	X	
	6	X	X	X	X	X	
	7	X	X	X	X	X	
	8		X		X	X	
	9		X		X	X	
	A		X		X	X	
	B		X		X	X	
	C		X		X		
	D		X		X		
	E		X		X		
	F		X		X		

PRELIMINARY

TABLE 3-8. UPMB Initializations for MB811171622A-100 upto 32MHz

Cycle Type	Single Read	Burst Read	Single Write	Burst Write	Refresh	Exception	
Offset In UPM	0	8	18	20	30	3C	
Contents @ Offset +	0	0126CC04	0026FC04	0E26BC04	0E26BC00	1FF5FC84	7FFFFC07
	1	0FB98C00	10ADFC00	01B93C00	10AD7C00	FFFFFC04	X
	2	1FF74C47	F0AFFC00	1FF77C47	F0AFFC00	FFFFFC84	X
	3	X	F1AFFC00	X	F0AFFC00	FFFFFC07	X
	4	X	EFBBBC00	X	E1BBBC04	X	
	5	1FE77C34 ^a	1FF77C47	X	1FF77C47	X	
	6	EFAABC34	X	X	X	X	
	7	1FA57C35	X	X	X	X	
	8		X		X	X	
	9		X		X	X	
	A		X		X	X	
	B		X		X	X	
	C		X		X		
	D		X		X		
	E		X		X		
	F		X		X		

a. MRS initialization. Uses Free space.

PRELIMINARY

TABLE 3-9. UPMB Initializations for MB811171622A-100, 32+MHz - 50MHz

Cycle Type		Single Read	Burst Read	Single Write	Burst Write	Refresh	Exception
Offset In UPM		0	8	18	20	30	3C
Contents @ Offset +	0	1F07FC04	1F07FC04	1F27FC04	1F07FC04	1FF5FC84	7FFFFC07
	1	EAEFC04	EAEFC04	EAEBC00	EAEBC00	FFFFC04	X
	2	11ADFC04	10ADFC04	01B93C04	10AD7C00	FFFFC04	X
	3	EFBBBC00	F0AFFC00	1FF77C47	F0AFFC00	FFFFC04	X
	4	1FF77C47	F0AFFC00	X	F0AFFC00	FFFFC84	
	5	1FF77C34 ^a	F1AFFC00	X	E1BBBC04	FFFFC07	
	6	EFEABC34	EFBBBC00	X	1FF77C47	X	
	7	1FB57C35	1FF77C47	X	X	X	
	8		X		X	X	
	9		X		X	X	
	A		X		X	X	
	B		X		X	X	
	C		X		X		
	D		X		X		
	E		X		X		
	F		X		X		

a. MRS initialization, Uses free space.

PRELIMINARY

4 - Functional Description

In this chapter the various modules combining the MPC8XXFADS are described to their design details.

4•1 Reset & Reset - Configuration

There are several reset sources on the FADS:

- 1) Keep Alive Power-On Reset^A
- 2) Regular Power On Reset
- 3) Manual Soft-Reset
- 4) Manual Hard-Reset
- 5) MPC Internal Sources. (See the appropriate Spec or U/M)

4•1•1 Keep Alive Power-On Reset

The Keep Alive Power - On Reset logic resides on the daughter board this since the Keep Alive power bus is on that board and it also allows the use of the daughter board connected directly to a user's application.

4•1•2 Regular Power - On Reset

The regular power on reset operates in the same manner as the keep alive power-on reset, using a similar device - the Seiko - S-8052ANY-NH-X with detection voltage of 2.595V to 2.805V. The reference voltage of this device is the MAIN VDDH bus of the MPC while the reset line asserted^B, is the HRESET* line.

When HRESET~ is asserted to the MPC, Hard-Reset configuration is made available to the MPC, via BCSR0. See [4•1•6•2 "Hard Reset Configuration" on page 29](#) and [TABLE 4-9. "BCSR0 Description" on page 46](#).

4•1•3 Manual Soft Reset

To support application development not around the debug port and resident debuggers, a soft reset push-button is provided. (SW2) Depressing that button, asserts the SRESET* pin of the MPC, generating a SOFT RESET sequence.

When the SRESET~ line is asserted to the MPC, the Soft-Reset configuration is made available to the MPC, by the debug-port controller. See [4•1•6•3 "Soft Reset Configuration" on page 29](#).

4•1•4 Manual Hard Reset

To support application development not around the debug port, a Hard-Reset push-button is provided^C. When the Soft Reset push-button (SW2) is depressed in conjunction with the ABORT push-button (SW1), the HRESET* line is asserted, generating a HARD RESET sequence. The button sharing is for economy and board space saving and does not effect in any way, functionality.

4•1•5 MPC Internal Sources

Since the HRESET* and SRESET* lines of the MPC are open-drain and the on-board reset logic drives these lines with open-drain gates, the correct operation of the internal reset sources of the MPC is facilitated. As a rule, an internal reset source asserts HRESET* and / or SRESET* for a minimum time of 512 system clocks. It is beyond the scope of this document to describe these sources, however Debug-Port Soft / Hard Resets which are part of the development system^D, are

A. In fact generated on the daughter board.

B. Again not directly.

C. It is not a dedicated button.

regarded as such.

4•1•6 Reset Configuration

During reset the MPC device samples the state of some external pins to determine its operation modes and pin configuration. There are 3 kinds of reset levels to the MPC each level having its own configuration sampled:

- 1) Power - On Reset configuration
- 2) Hard Reset configuration
- 3) Soft Reset Configuration.

4•1•6•1 Power - On Reset Configuration

Just before PORESET* is negated by the external logic, the power-on reset configuration which include the MODCK(1:2) pins is sampled. These pins determine the clock operation mode of the MPC. Two clock modes are supported on the MPC8XXFADS:

- 1) 1:5 PLL operation via on-board clock generator.
In this mode MODCK(1:2) are driven with '11' during^A power on reset.
- 2) 1:513 PLL operation via on-board clock generator.
In this mode MODCK(1:2) are driven with '00'. during power-on reset.

4•1•6•2 Hard Reset Configuration

During HARD reset sequence, when RSTCONF* pin is asserted, the MPC data bus state is sampled to acquire the MPC's hard reset configuration. The reset configuration word is driven by BCSR0 register, defaults of which are set during power-on reset. The BCSR0 drives half of the configuration word, i.e., data bits D(0:15) in which the reserved bits are designated RSRVxx. If the hard-reset configuration is to be changed^B, BCSR0 may be written with new values, which become valid after HARD reset is applied to the MPC.

On the FADS, the RSTCONF* line is always driven during HARD reset, i.e., no use is possible with the MPC's internal HARD reset configuration defaults.

The system parameters to which BCSR0 defaults during power-on reset and are driven at hard-reset, are listed below:

- 1) Arbitration: internal arbitration is selected.
- 2) Interrupt Prefix: The internal default is interrupt prefix at 0xFFFF0000. It is overridden to provide interrupt prefix at address 0, which is located within the DRAM.
- 3) Boot Disable: Boot is enabled.
- 4) Boot Port Size: 32 bit boot port size is selected.
- 5) Initial Internal Space Base: Immediately after HARD reset, the internal space is located at \$FF000000.
- 6) Debug pins configuration: PCMCIA port B^C pins become PCMCIA port B pins.
- 7) Debug port pins configuration. Debug port pins are on the JTAG port.
- 8) External Bus Division Factor: 1:1 internal to external clocks' frequencies ratio is selected.

4•1•6•3 Soft Reset Configuration

The rising edge of SRESET* is used to configure the development port. Before the negation of SRESET*, DSCK^D is sampled to determine for debug-mode enable / disable. After SRESET* is

D. And therefore mentioned.

A. The MODCK lines are in fact driven longer - by HRESET~ line.

B. With respect the FADS's power-on defaults.

C. Where they exist.

negated, if debug mode was enabled, DSCK is sampled again for debug-mode entry / non-entry.

DSDI is used to determine the debug port clock mode and is sampled after the negation of SRESET*.

The Soft Reset configuration is provided by the debug-port controller via the ADI I/F. Option is given to enter debug mode directly or only after exception.

4.2 Local Interrupter

The only external interrupt which is applied to the MPC via its interrupt controller is the ABORT (NMI), which is generated by a push-button. When this button is depressed, the NMI input to the MPC is asserted. The purpose of this type of interrupt, is to support the use of resident debuggers if any is made available to the FADS. All other interrupts to the MPC, are generated internally by the MPC's peripherals and by the debug port.

To support external (off-board) generation of an NMI, the IRQ0* line which is routed as an NMI input, is driven by an open-drain gate. This allows for external h/w to also drive this line. If an external h/w indeed does so, it is compulsory that IRQ0* is driven by an open-drain (or open-collector) gate.

4.3 Clock Generator^A

There are 2 ways to clock the MPC on the MPC8XXFADS:

- 1) 3 - 5MHz Clock generator^B connected to CLK4IN input. 1:5 PLL mode.
- 2) 32.768 KHz crystal resonator^B via EXTAL-XTAL pair of the MPC, 1:513 initial PLL multiplication factor.

The selection between the above modes is done using Dip-switch (DS2 / 4) with dual functionality: it is responsible to the combination driven to the MODCK lines during power-on reset and to the connection of the appropriate capacitor between MPC's XFC and VDDSYN lines to match the PLL's multiplication factor. When 1:5 mode is selected, a capacitor of 5nF is connected, while when 1:513 mode is selected a 0.68μF capacitor is connected parallel to it via a TMOS gate. The capacitors' values are calculated to support a wider range of multiplication factors as possible.

When mode (2) above is selected, the output of the clock generator is gated from EXTCLK input and driven to '0' constantly so that a jitter-free system clock is generated.

On-board logic is clocked by the MPC's CLKOUT coming from the Daughter board. This clock is multiplexed with the debug port's clock generator, so that on-board logic is always clocked, even when the MPC is removed from its socket^C.

4.4 Buffering

As the FADS meant to serve also as a hardware development platform, it is necessary to buffer the MPC from the local bus, so the MPC's capacitive drive capability is not wasted internally and remains available for user's off-board applications via the expansion connectors.

Buffers are provided for address and strobe^D lines while transceivers are provided for data. Since the capacitive load over dram's address lines might^E exceed 200 pF, the dram address lines are separately buffered. Use is done with 74LCX buffers which are 3.3V operated and are 5V tolerant. This

D. DSCK is configured at hard-reset to reside on the JTAG port.

A. Although this module resides on the DAUGHTER boards, it is described here, as it is common to all MPC8XX supported.

B. Located On the Daughter Board.

C. When the FADS serves a debug station for target system.

D. If necessary.

E. Depended on dram SIMM's internal structure.

type of buffers reduces noise on board due to reduced transitions' amplitude.

To further reduce noise and reflections, series resistors **are** placed over dram's address and strobe lines.

The data transceivers open only if there is an access to a valid^{A B} board address or during Hard - Reset configuration^C. That way data conflicts are avoided in case an off-board memory is read, provided that it is not mapped to an address valid on board. It is the users' responsibility to avoid such errors.

4•5 Chip - Select Generator

The memory controller of the MPC **is** used as a chip-select generator to access on-board^D memories, saving board's area reducing cost, power consumption and increasing flexibility. To enhance off-board application development, memory modules (including the BCSR_x) **may** be disabled via BCSR1^E in favor of an external memory connected via the expansion connectors. That way, a CS line **may** be used off-board via the expansion connectors, while its associated local memory is disabled.

When a CS region **is** disabled via BCSR1, the local data transceivers do not open during access to that region, avoiding possible^F contention over data lines.

The MPC's chip-selects assignment to the various memories / registers on the FADS are as shown in [TABLE 4-1. "MPC8XXFADS Chip Selects' Assignment"](#) below:

TABLE 4-1. MPC8XXFADS Chip Selects' Assignment

<i>Chip Select:</i>	<i>Assignment</i>
CS0*	Flash Memory
CS1*	BCSR
CS2*	DRAM Bank 1
CS3*	DRAM Bank 2 ^a
CS4*	SDRAM
CS(5-7)*	Unused, user available

a. If exists.

4•6 DRAM

The MPC8XXFADS **is** provided with 4 MBytes of 60nsec delay EDO Dram SIMM. Support **is** given to any 5V powered FPM / EDO Dram SIMM configured as 1M X32 upto 2 X 4M X 32, with 60 nsec or 70nsec delay.

All dram configurations **are** supported via the Board Control & Status Register (BCSR), i.e., DRAM size (4M to 32M) and delay (60 / 70 nsec) **are** read from BCSR2 and the associated registers (includ-

- A. An address which covered in a Chip-Select region.
- B. Except for SDRAM, which is Unbuffered.
- C. To allow a configuration word stored in Flash memory become active.
- D. And off-board. See further.
- E. After the BCSR is removed from the local memory map, there is no way to access it but to re-apply power to the FADS.
- F. During read cycles.

ing the UPM) are programmed accordingly.

Dram timing control is performed by UPMA of the MPC via CS2 (and CS3 for a dual-bank SIMM) region(s), i.e., RAS and CAS signals' generation, during normal^A access as well as during refresh cycles and the necessary address multiplexing^B are performed using UPMA. CS2* and CS3* signals are buffered from the DRAM and each is split to 2 to overcome the capacitive load over the Dram SIMM RAS lines.

The DRAM module may enabled / disabled at any time by writing the DRAMEN~ bit in BCSR1. See TABLE 4-10. "BCSR1 Description" on page 48.

4•6•1 DRAM 16 Bit Operation

To enhance evaluation capabilities, support is given to Dram with 16-bit and 32-bit data bus width. That way users can tailor dram configuration, to get best fit to their application requirements. When the DRAM is in 16 bit mode, half of it can not be used, i.e., the memory portion that is connected to data lines D(16:31).

To configure the DRAM for 16 bit data bus width operation, the following steps should be taken:

- 1) Set the Dram_Half_Word bit in BCSR1 to Half-Word. See TABLE 4-10. "BCSR1 Description" on page 48
- 2) The Port Size bits of BR2~ (and of BR3~ for a 2-bank DRAM simm) should be set to 16 bits.
- 3) The AM bits in OR2 register should be set to $\frac{1}{2}$ of the nominal single-bank DRAM simm volume or to $\frac{1}{4}$ of the nominal dual-bank DRAM simm volume.

If a Dual-Bank DRAM simm is being used:

- 4) The Base-Address bits in BR3 register should be set to DRAM_BASE + $\frac{1}{4}$ Nominal_Volume, that is, if a contiguous block of DRAM is desired.
- 5) The AM bits of OR3 register, should be set to $\frac{1}{4}$ Nominal_Volume.

If the above is executed out of running code, than this code **should not reside on the DRAM** while executing, otherwise, erratic behavior is likely to be demonstrated, resulting in a system crash.

4•6•2 DRAM Performance Figures

The projected performance figures for the dram are shown in TABLE 4-2. "Regular DRAM Perfor-

A. Normal i.e.: Single Read, Single Write, Burst Read & Burst Write.

B. Taking into account support for narrower bus widths.

performance Figures" on page 33 and in TABLE 4-3. "EDO DRAM Performance Figures" on page 33.

TABLE 4-2. Regular DRAM Performance Figures

System Clock Frequency [MHz]	Number of System Clock Cycles			
	50		25	
DRAM Delay [nsec]	60	70	60	70
Single Read	6	6	3	4
Single Write	4	4	3	3
Burst Read	6,2,3,2	6,3,2,3	3,2,2,2	4,2,2,2
Burst Write	4,2,2,2	4,2,2,2	3,1,2,2	3,2,2,2
Refresh	21 ^{a b}	25 ^{a b}	13 ^{a b}	13 ^{a b}

- a. Four-beat refresh burst.
- b. Not including arbitration overhead.

TABLE 4-3. EDO DRAM Performance Figures

System Clock Frequency [MHz]	Number of System Clock Cycles			
	50		25	
DRAM Delay [nsec]	60	70	60	70
Single Read	6	6	3	4
Single Write	4	4	2	3
Burst Read	6,2,2,2	6,3,2,2	3,1,1,1	4,1,2,2
Burst Write	4,2,2,2	4,2,2,2	2,1,1,1	3,2,2,2
Refresh	21 ^{a b}	25 ^{a b}	13 ^{a b}	13 ^{a b}

- a. Four-beat refresh burst.
- b. Not including arbitration overhead.

4•6•3 Refresh Control

The refresh to the dram is a CAS before RAS refresh, which is controlled by UPMA as well. The refresh logic is clocked by the MPC's BRG clock which is not influenced by the MPC's low-power divider.

FIGURE 4-1 Refresh Scheme



As seen in FIGURE 4-1 "Refresh Scheme" above, the BRG clock is twice divided: once by the PTP (Periodic Timer Prescaler) and again by another prescaler - the PTA, dedicated for each UPM. If there are more than one dram banks, than refresh cycles are performed for consecutive banks, therefore, refresh should be made faster. The formula for calculation of the PTA is given below:

$$PTA = \frac{\text{Refresh_Period} \times \text{Number_Of_Beats_Per_Refresh_Cycle}}{\text{Number_Of_Rows_To_Refresh} \times T_BRG \times MPTPR \times \text{Number_Of_Banks}}$$

Where:

- PTA - Periodic Timer A filed in MAMR. The value of the 2'nd divider.
- Refresh_Period is the time (usually in msec) required to refresh a dram bank
- Number_Of_Beats_Per_Refresh_Cycle: using the UPM looping capability, it is possible to perform more than one refresh cycle per refresh burst (in fact upto 16).
- Number_Of_Rows_To_Refresh: the number of rows in a dram bank
- T_BRG: the cycle time of the BRG clock
- MPTPR: the value of the periodic timer prescaler (2 to 64)
- Number_Of_Banks: number of dram banks to refresh.

If we take for example a MCM36200 SIMM which has the following data:

- Refresh_Period == 16 msec
- Number_Of_Beats_Per_Refresh_Cycle: on the FADS it is 4.
- Number_Of_Rows_To_Refresh == 1024
- T_BRG == 20 nsec (system clock @ 50 Mhz)
- MPTPR arbitrarily chosen to be 16
- Number_Of_Banks == 2 for that SIMM

If we assign the figures to the PTA formula we get the value of PTA should be 97 decimal or 61 hex.

4•6•4 Variable Bus-Width Control

Since a port's width determines its address lines' connection scheme, i.e., the number of address lines required for byte-selection varies (1 for 16-bit port and 2 for 32-bit port) according to the port's width, it is necessary to change address connections to a memory port if its width is to be changed. E.g.: if a certain memory is initially configured as a 32-bit port, the list significant address line which is connected to that memory's A0 line should be the MPC's A29. Now, if that port is to be reconfigured as a 16-bit port, the LS address line becomes A30.

If a linear^A address scheme is to be maintained, all address lines connected to that memory are to

A. Consequent addresses lead to adjacent memory cells

be shifted one bit, this obviously involves extensive multiplexing (passive or active). If linear addressing scheme is not a must, than only minimal multiplexing is required to support variable port width.

In [TABLE 4-4. "DRAM ADDRESS CONNECTIONS"](#) below, the FADS's dram address connection scheme is presented:

TABLE 4-4. DRAM ADDRESS CONNECTIONS

Width	32 - Bit		16 - Bit	
	Depth		Depth	
Drum ADD	4 M	1 M	4 M	1 M
A0	BA29	BA29	BA29	BA29
A1	BA28	BA28	BA28	BA28
A2	BA27	BA27	BA27	BA27
A3	BA26	BA26	BA26	BA26
A4	BA25	BA25	BA25	BA25
A5	BA24	BA24	BA24	BA24
A6	BA23	BA23	BA23	BA23
A7	BA22	BA22	BA22	BA22
A8	BA21	BA21	BA21	BA21
A9	BA20	BA20	BA20	BA30
A10	BA19		BA30	

As can seen from the table above, most of the address lines remain fixed while only 2 lines (the shaded cells) need switching. The switching scheme is shown in [FIGURE 4-2 "DRAM Address Lines' Switching Scheme"](#) on page 35. The switches on that figure are implemented by active multiplexers controlled by the BCSR1/Dram_Half_Word* bit.

FIGURE 4-2 DRAM Address Lines' Switching Scheme

4•7 Flash Memory SIMM

The MPC8XXFADS is provided with 2Mbyte of 90 nsec flash memory SIMM - the MCM29020 by Motorola. Support is given also to 4MBytes MCM29F040, 8 MBytes MCM29F080, 4 MBytes SM73218 and to 8 MBytes SM73228 by Smart Technology. The Motorola SIMMs are internally composed of 1, 2 or 4 banks of 4 Am29F040 compatible devices, while the Smart SIMMs are arranged as 1 or 2 banks of four 28F008 devices by Intel. The flash SIMM resides on an 80 pin SIMM socket.

To minimize use of MPC's chip-select lines, only one chip-select line (CS0~) is used to select the flash as a whole, while distributing chip-select lines among the internal banks is done via on-board programmable logic, according to the Presence-Detect lines of the Flash SIMM inserted to the FADS.

FIGURE 4-3 Flash Memory SIMM Architecture



The access time of the Flash memory provided with the FADS is 90 nsec, however, 120 nsec devices may be used as well. Reading the delay section of the Flash SIMM Presence-Detect lines, the debugger establishes (via OR0) the correct number of wait-states (considering 50MHz system clock frequency).

The Motorola SIMMs are built of AMD's Am29F0X0 devices which are 5V programmable, i.e., there is no need for external programming voltage and the flash may be written almost^A as a regular memory.

The SMART parts however, require 12V ± 0.5% programming voltage to be applied for programming. If on-boards programming of such device is required, a 12V supply needs to be connected to the FADS (P7). Otherwise, for normal^B Flash operation, 12V supply is not required.

The control over the flash is done using the GPCM and a dedicated CS0~ region, controlling the whole bank. During hard - reset initializations, the debugger reads the Flash Presence-Detect lines via BCSR2 and decides how to program BR0 & OR0 registers, within which the size and the delay of the region are determined.

A. A manufacturer specific dedicated programming algorithm should be implemented during flash programming.

B. I.e., Read-Only.

The performance of the flash memory is shown in [TABLE 4-5. "Flash Memory Performance Figures" below](#):

TABLE 4-5. Flash Memory Performance Figures

System Clock Frequency [MHz]	Number of System Clock Cycles			
	50		25	
Flash Delay [nsec]	90	120	90	120
Read / Write ^a Access [Clocks]	8	10	4	5

a. The figures in the table refer to the actual write access. The write operation continues internally and the device has to be polled for operation completion.

The Flash module may disabled / enabled at any time by writing '1' / '0' the FlashEn~ bit in BCSR1.

4•8 Synchronous Dram

To enhance performance, especially in higher operation frequencies - 4 MBytes of SDRAM is provided on board. The SDRAM is unbuffered from the MPC bus and is configured as 2 X 512K X 32. Use is done with two MB811171622A-100 chips by Fujitsu or compatibles.

To enhance performance, the SDRAM is unbuffered from the MPC, saving the delay associated with address and data buffers. Since only 2 memory chips are involved, it does not adversely effect overall system performance. The SDRAM does not reside on a SIMM but is soldered directly to the FADS pcb. The SDRAM may be enabled / disabled at any time by writing 1 / 0 to the SDRAMEN bit in BCSR1. See [TABLE 4-10. "BCSR1 Description" on page 48](#).

The SDRAM's timing is controlled by UPMB via its assigned CS (See [TABLE 4-1. "MPC8XXFADS Chip Selects' Assignment" on page 31](#)) line. Unlike a regular dram the synchronous dram has a CS input in addition to the RAS and CAS signals.

The sdram connection scheme is shown in [FIGURE 4-4 "SDRAM Connection Scheme" on page 38](#).

The SDRAM's performance figures, are shown in [TABLE 4-6. "Estimated SDRAM Performance Figures"](#):

TABLE 4-6. Estimated SDRAM Performance Figures

System Clock Frequency [MHz]	Number of System Clock Cycles	
	50	25
Single Read	5	3
Single Write	3+1 ^a	2 + 1 ^a
Burst Read	5,1,1,1	3,1,1,1
Burst Write	3,1,1,1 + 1 ^a	2,1,1,1 + 1 ^a
Refresh	21 ^b	13 ^b

a. One additional cycle for RAS precharge

b. 4-beat Refresh Burst, not including arbitration overhead.

FIGURE 4-4 SDRAM Connection Scheme



4•8•1 SDRAM Programming

After power-up, the sdram needs to be initialized by means of programming, to establish its mode of operation. Sdram is programmed by issuing a Mode Register Set command. During that command data is passed to the Mode Register through the sdram's address lines. This command is fully supported by the UPM by means of a dedicated Memory Address Register and a UPM command run option.

Mode Register programming values are shown in [TABLE 4-7. "SDRAM's Mode Register Program-](#)

ming" below:

TABLE 4-7. SDRAM's Mode Register Programming

SDRAM Option	Value @ Frequency	
	50MHz	25MHz
Burst Length	4	4
Burst Type	Sequential	Sequential
CAS Latency	2	1
Write Burst Length	Burst	Burst

4•8•1•1 SDRAM Initializing Procedure

After Power-up the SDRAM needs to be initialized in a certain manner, described below:

- 1) UPMB should be programmed with values described in TABLE 3-8. "UPMB Initializations for MB811171622A-100 upto 32MHz" on page 26 or in TABLE 3-9. "UPMB Initializations for MB811171622A-100, 32+MHz - 50MHz" on page 27.
- 2) Memory controller's MPTPR, MBMR, OR4 and BR4 registers should be programmed according to TABLE 3-6. "Memory Controller Initializations For 20Mhz" on page 22 or TABLE 3-3. "Memory Controller Initializations For 50Mhz" on page 19.
- 3) MAR should be set with proper value (0x48 for upto 32MHz or 0x88 for 32 - 50 MHz)
- 4) MCR should be written with 0x80808105 to run the MRS command programmed in locations 5 - 8 of UPMB.
- 5) MBMR's TLFB field should be changed to 8, to constitute 8-beat refresh Bursts.
- 6) MCR should be written with 0x80808130 to run the refresh sequence (8 refresh cycles are performed now)
- 7) MBMR's TLFB field should be restored to 4, to provide 4-beat refresh Bursts for normal operation. The SDRAM is initialized and ready for operation.

4•8•2 SDRAM Refresh

The SDRAM is refreshed using its auto-refresh mode. I.e., using UMPB's periodic timer, a burst of four auto-refresh commands is issued to the SDRAM every 62.4 μsec, so that all 2048 SDRAM rows are refreshed within specified 32.8 msec.

4•9 Communication Ports

Since the FADS platform is meant to serve all the MPC8XX family, it only contains modules that are common to all family members. The various communication ports for the present and future family members are shown in TABLE 4-8. "MPC8XX Family Comm. Ports" below:

TABLE 4-8. MPC8XX Family Comm. Ports

Comm. Port	Family Member - MPC					
	801	823	821	860	860SAR	860T
SCC1	Uart, IrDA	USB	✓ +Enet	✓ +Enet	✓ +Enet	✓ +Enet
SCC2	Uart, IrDA	✓ +Enet, Fast IrDA	✓ +IrDA	✓ +Enet, IrDA	✓ +Enet, IrDA	✓ +Enet, IrDA
SCC3				✓ +Enet	✓ +Enet	✓ +Enet
SCC4				✓ +Enet	✓ +Enet	✓ +Enet
SMC1		✓ Uart	✓ Uart	✓ Uart	✓ Uart	✓ Uart
SMC2		✓ TDM Only	✓ Uart	✓ Uart	✓ Uart	✓ Uart
SPI ^a	✓	✓	✓	✓	✓	✓
I ² C ^a	✓	✓	✓	✓	✓	✓
Fast Enet						✓
Utopia					✓	

a. This is an interchip protocol and therefore will not be supported for evaluation.

As can be seen from the above table the Ethernet, I/R and Uart (RS232) support are common to all^A family members. Therefore, the FADS is equipped with 2 port of RS232, each with independent enable via BCSR and an IRDA transceiver, supporting Fast IRDA.

4•9•1 Ethernet Port

An Ethernet port with T.P. (10-Base-T) I/F is provided on the MPC8XXFADS. The comm. port over which this port resides, is determined according to the MPC type^B. Use is done with the MC68160 EEST 10-base-T transceiver, used also with the MPC8XXFADS.

To allow alternative use of the Ethernet's SCC pins, they appear at the expansion connectors over the daughter-board and over the Comm. Ports expansion connector (P8) of the this board, while the Ethernet transceiver may be Disabled / Enabled at any time by writing '1' / '0' to the EthEn~ bit in BCSR1.

4•9•2 Infra-Red Port

An infra-Red communication port is provided with the FADS - the Temic's TFDS 6000 integrated transceiver, which incorporates both the receiver and transmitter optical devices with the translating logic and supports Fast IrDA (upto 4 Mbps). The comm. port over which this port resides, is deter-

A. Except for the MPC801 which does not have Ethernet support.

B. I.e., routing is done on the daughter board.

mined according to the MPC type^B.

To allow alternative use of the I/R's SCC or its pins, the infra-red transceiver may be disabled / enabled at any time, by writing '1' / '0' to the IrdEn~ bit in BCSR1, while all pins appear on the daughter-board expansion connector, as well as on P8 of this board.

4•9•2•1 Infra-Red Port Rate Range Selection

The TFDS6000 has 2 bit-rate ranges:

- 1) 9600 Bps to 1.2 MBps
- 2) 1.2 MBps to 4 MBps.

Selection between the 2 ranges is determined by the state of the transceiver's TX input on the falling edge of IrdEn~.

When TX input is LOW at least 200 nsec before the falling edge of IrdEn~, then, the LOWER range is selected. If TX is HIGH for that period of time, then, the HIGHER range is selected.

4•9•3 RS232 Ports

To assist user's applications and to provided convenient communication channels with both a terminal and a host computer, two identical RS232 ports are provided on the FADS. The MPC's communication ports to which these RS232 ports is routed, is established according to the type of MPC residing on the daughter board. Use is done with MC145707 transceivers which generates RS232 levels internally using a single 5V supply and are equipped with OE and shutdown mode. When the RS232EN1 or RS232EN2 bits in BCSR1 are asserted (low), the associated transceiver is enabled. When negated, the associated transceiver enters standby mode, in which the receiver outputs are tri-stated, enabling use of the associated port's pins, off-board via the expansion connectors.

Use is done with 9 pins, female D-Type stacked connector, configured to be directly (via a flat cable) connected to a standard IBM-PC like RS232 connector.

FIGURE 4-5 RS232 Serial Ports' Connector

DCD	1	6	DSR
TX	2	7	RTS
TX	3	8	CTS
DTR	4	9	N.C.
GND	5		

4•9•3•1 RS-232 Ports' Signal Description

In the list below, the directions 'I', 'O', and 'I/O' are relative to the FADS board. (I.e. 'I' means input to the FADS)

- CD (O) - Data Carrier Detect. This line is always asserted by the FADS.
- TX (O) - Transmit Data.
- RX (I) - Receive Data.
- DTR (I) - Data Terminal Ready. This signal may be used by the software on the FADS to detect if a terminal is connected to the FADS board.
- DSR^A (O) - Data Set Ready. This line is always asserted by the FADS.
- RTS (I) - Request To Send. This line is not connected in the FADS.
- CTS (O) - Clear To Send. This line is always asserted by the FADS.

A. Since there are only 3 RS232 transmitters in the device, DSR is connected to CD.

4•10 PCMCIA Port^A

To enhance PCMCIA i/f development, a dedicated PCMCIA port is provided on the FADS. Support **is** given to 5V **only** PC-Cards, PCMCIA standard 2.1+ compliant. All the necessary control signals **are** generated by the MPC itself. To protect MPC signals from external hazards, and to provide sufficient drive capability, a set of buffers and latches **is** provided over PC-Card's address, data & strobe lines.

To conform with the design spirit of the FADS, i.e., making as much as possible MPC resources available for external application development, input buffers **are** provided for input control signals, controlled by the PCC_EN~ bit in BCSR1, so the PCMCIA port may be Disabled / Enabled at any time, by writing '1' / '0' to that bit. When the PCMCIA channel **is** disabled, its associated pins **are** available for off-board use via the expansion connectors.

A loudspeaker **is** provided on board and connected to SPKROUT line of the MPC. The speaker is buffered from the MPC and low-pass filtered. When the PCC_EN~ bit in BCSR1 is negated (**high**) the speaker buffer is tri-stated so the SPKROUT signal of the MPC may be used for alternate function.

Since it is not desirable^B to apply control signals to unpowered PC-Card, the strobe / data signal buffers / transceivers **are** tri-stated and may be driven only when the PC-Card **is** powered.

The block diagram of the PCMCIA port is shown in [FIGURE 4-6 "PCMCIA Port Configuration"](#) on [page 43](#).

-
- A. As the MPC801 does not have a PCMCIA port, this port **is** not operational with an MPC801 daughter board.
B. This since the PC-Card might have protection diodes on its inputs, which will force down input signals regardless of their driven level.

FIGURE 4-6 PCMCIA Port Configuration



4•10•1 PCMCIA Power Control

To support hot-insertion^A the socket's power is controlled via a dedicated PCMCIA power controller the LTC1315 made by LINEAR TECHNOLOGY. This device, controlled by BCSR1, switches 12V VPP for card programming and controls gates of external MOSFET transistors, through which the PC Card VCC is switched.

When a card is inserted while the channel is enabled via BCSR1, i.e., both of the CD(1:2)* (Card Detect) lines are asserted (low), the status of the voltage select lines VS(1:2)* should be read to determine the PC Card's operation voltage level according to which, PCCVCC(0:1) bits in BCSR1 should be set, to drive the correct VCC (5V) to the PC-Card.

When a card is being removed from the socket while the channel is enabled via BCSR1, the negation of CD1~ and CD2~ may be sensed by the MPC and power supply to the card may be cut.

WARNING

Any application S/W handling the PCMCIA channel must check the Voltage-Sense lines before Power is applied to the PC-Card. Otherwise, if 5V power is applied to a 3.3V-Only card, permanent damage will be inflicted to the PC-Card.

4•11 Board Control & Status Register - BCSR

Most of the hardware options on the MPC8XXFADS are controlled or monitored by the BCSR, which is a 32^B bit wide read / write register file. The BCSR is accessed via the MPC's CS1 region and in fact includes 5 registers: BCSR0 to BCSR4. Since the minimum block size for a CS region is 32KBytes, BCSR0 - BCSR4 are multiply duplicated within that region. See also [TABLE 3-1. "MPC8XXADS Main Memory Map" on page 17.](#)

The following functions are controlled / monitored by the BCSR:

- 1) MPC's Hard Reset Configuration.
- 2) Flash Module Enable / Disable
- 3) Dram Module Enable / Disable
- 4) Dram port width - 32 bit / 16 bit.
- 5) SDRAM Module Enable / Disable.
- 6) Ethernet port Enable / Disable.
- 7) Infra-Red port Enable / Disable.
- 8) RS232 port 1 Enable / Disable.
- 9) RS232 port 2 Enable / Disable.
- 10) BCSR Enable / Disable.
- 11) Hard Reset Configuration Source - BCSR0 / Flash^C Memory
- 12) PCMCIA control which include:
 - Channel Enable / Disable.
 - PC Card VCC appliance.
 - PC Card VPP appliance.
- 13) USB^D Port Enable or Utopia^E Port Enable or 100-Base-T^F Port Enable

A. I.e., card insertion when the FADS is powered

B. In fact only the upper 16 bits - D(0:15) are used, but the BCSR is mapped as a 32 bit wide register and should be accessed as such.

C. Provided that support is provided also within the MPC.

- 14) USB Power Control.
- 15) Video Port Enable
- 16) Video Port Clock Select
- 17) Ethernet Port Control.
- 18) Dram Type / Size and Delay Identification.
- 19) Flash Size / Delay Identification.
- 20) External (off-board) tools identification or S/W option selection switch - DS1 status.
- 21) Daughter Board ID.
- 22) Mother Board Revision code
- 23) Daughter Board Revision code

Since all of the FADS's modules are controlled by the BCSR and since they may be disabled in favor of external hardware, the enable signals for these modules are presented at both the daughter board connector and at the expansion connector over the daughter board, so that off-board hardware may be mutually exclusive enabled with on-board modules.

4•11•1 BCSR Disable Protection Logic

The BCSR itself may be disabled in favor of off-board logic. To avoid accidental disable of the BCSR, an event from which only power re-appliance recovers, protection logic is provided:

The BCSR_EN~ bit resides on BCSR1. This bit wakes-up active (low) during power-up and may not be changed^A unless BCSR_EN_PROTECT~ bit in BCSR3 is written with '1' previously.

After the BCSR_EN_PROTECT~ is written with '1' to unprotect the BCSR_EN~ bit there is only one shot at disabling the BCSR, since, immediately after any write to BCSR1, BCSR_EN_PROTECT~ is re-activated and BCSR_EN~ is re-protected and the disabling procedure has to be repeated if desired.

4•11•2 BCSR0 - Hard Reset Configuration Register

BCSR0 is located at offset 0 on BCSR space. It may be read or written at any time^B. BCSR0 gets its defaults upon MAIN^C Power-On reset. During Hard-Reset data contained in BCSR0 is driven on the data bus to provide the Hard-Reset configuration for the MPC, this, if the Flash_Configuration_Enable~ bit in BCSR1 is not active. BCSR0 may be written at any time to change the Hard-Reset configuration of the MPC. The new values become valid when the next Hard-Reset is issued to the MPC regardless of the Hard-Reset source. The description of BCSR0 bits is

-
- D. For the MPC823 daughter board
 - E. For the MPC860SAR daughter board
 - F. For the MPC860T daughter board
 - A. It may be written but will not be influenced.
 - B. Provided that BCSR is not disabled.
 - C. I.e., when VDDH to the MPC is powered.

shown in TABLE 4-9. "BCSR0 Description" on page 46.

TABLE 4-9. BCSR0 Description

BIT	MNEMONIC	FUNCTION	PON DEF.	ATT
0	ERB	External Arbitration. When '0' during Hard-Reset, Arbitration is performed internally. When '1' during Hard-Reset, Arbitration is performed externally.	0	R,W
1	IP	Interrupt Prefix. When '0' during Hard-Reset, Interrupt prefix set to 0xFFFF0000, if '1' Interrupt Prefix set to 0.	0	R,W
2	Reserved	Implemented ^a	0	R,W
3	BDIS	Boot Disable. When '0' during Hard-Reset, CS0~ region is enabled for boot. When '1', CS0~ region is disabled for boot.	0	R,W
4 - 5	BPS(0:1)	Boot Port Size. Determines the port size for CS0~ at boot. '00' - 32 bit, '01' - 8 bit, '10' - 16 bit, '11' - reserved.	'00'	R,W
6	Reserved	Implemented ^a	0	R,W
7 - 8	ISB(0:1)	Initial Space Base. Value during Hard-Reset determines the initial base address of the internal MPC memory map. When '00' - initial space at 0, when '01' - initial space at 0x00F00000, when '10' - initial space at 0xFF000000, when '11' - initial space at 0xFFFF00000.	'10'	R,W
9 - 10	DBGC(0:1)	Debug Pins Configuration. Value during Hard-Reset determines the function of the PCMCIA channel II pins. When '00' - these pins function as PCMCIA channel II pins, when '01' - they serve as Watch-Points,'10' - Reserved, when '11' - they become show-cycle attribute pins, e.g., VFLS, VF...	'11'	R,W
11-12	DBPC(0:1)	Debug Port Pins Configuration. Value during Hard-Reset determines the location of the debug port pins. When '00' - debug port pins are on the JTAG port, when '01' - debug port non-existent, '10' - Reserved, when '11' debug port is on PCMCIA channel II pins.	'00'	R,W
13 - 14	EBDF(0:1) ^b	External Bus Division Factor. Value during Hard Reset determines the factor upon which the CLKOUT of the MPC external bus, is divided with respect to its internal MPC clock. When '00' - CLKOUT is GCLK2 divided by 1, when '01', CLKOUT is GCLK2 divided by 2.	'00'	R,W
15	Reserved	Implemented ^a .	'0'	R,W
16 - 31	Reserved	Un-Implemented	-	-

a. May be read and written as any other fields and are presented at their associated data pins during Hard-Reset.

b. Applicable for MPC's revision A or above. Otherwise have no influence.

4•11•3 BCSR1 - Board Control Register 1

The BCSR1 serves as a control register on the FADS. It is accessed at offset 4 from BCSR base address. It may be read or written at any time^A. BCSR1 gets its defaults upon Power-On reset. Most of BCSR1 pins are available at the daughter board connectors and on the expansion connectors

A. Provided that BCSR is not disabled.



residing over the daughter boards, providing visibility towards daughter boards' and external logic.

Freescale Semiconductor, Inc.

PRELIMINARY

BCSR1 fields are described in [TABLE 4-10. "BCSR1 Description" on page 48.](#)

TABLE 4-10. BCSR1 Description^a

<i>BIT</i>	<i>MNEMONIC</i>	<i>Function</i>	<i>PON DEF</i>	<i>ATT.</i>
0	FLASH_EN	Flash Enable. When this bit is active (low), the Flash memory module is enabled on the local memory map. When in-active, the Flash memory is removed from the local memory map and CS0~, to which the Flash memory is connected may be used off-board via the expansion connectors.	0	R,W
1	DRAM_EN	Dram Enable. When this bit is active (low), the DRAM module is enabled on the local memory map. When in-active, the DRAM is removed from the local memory map and CS2~ and CS3~ ^b , to which the DRAM is connected may be used off-board via the expansion connectors.	0	R,W
2	ETHEN	Ethernet Port Enable. When asserted (low) the EEST connected to SCC1 is enabled. When negated (high) that EEST is in standby mode, while all its system i/f signals are tri-stated.	1	R,W
3	IRDEN	Infra-Red Port Enable. When asserted (low), the Infra-Red transceiver, connected to SCC2 is enabled. When negated, the Infra-Red transceiver is put in shutdown mode. And SCC2 pins are available for off-board use via the expansion connectors.	1	R,W
4	FLASH_CFG_EN	Flash Configuration Enable. When this bit is asserted (low): (A) - the Hard-Reset configuration held in BCSR0 is NOT driven on the data bus during Hard-Reset and (B) - configuration data held at the 1 st word of the flash memory is driven to the data bus during Hard-Reset. ^c	1	R,W
5	CNT_REG_EN_P ROTECT	Control Register Enable Protect. When this bit is active (low) the BCSR_EN bit in that register can not be written. When in-active, BCSR_EN may be written to remove the BCSR from the memory map. After any write to BCSR1 this bit becomes active again. This bit is a read-only ^d bit on that register.	0	R
6	BCSR_EN	BCSR Enable. When this bit is active (low) the Board Control & Status Register is enabled on the local memory map. When inactive, the BCSR may not be read or written and its associated CS1~ is available for off-board use via the expansion connectors. This bit may be written with '1' only if CNT_REG_EN_PROTECT bit is negated (1). When the BCSR is disabled it still continues to configure the board according the last data held in it even during Hard-Reset.	0	R,W
7	RS232EN_1	RS232 port 1 Enable. When asserted (low) the RS232 transceiver for port 1, is enabled. When negated, the RS232 transceiver for port 1, is in standby mode and the relevant MPC communication port pins are available for off-board use via the expansion connectors.	1	R,W
8	PCCEN	PC Card Enable. When asserted (low), the on-board PCMCIA channel is enabled, i.e., address and strobe buffers are enabled to / from the card. When negated, all buffers to / from the PCMCIA channel are disabled allowing off-board use of its associated lines.	1	R,W
9	PCCVCC0	Pc Card VCC Select 0. These signal in conjunction with PCCVCC1 determine the voltage applied to the PCMCIA card's VCC. Possible values are 0 / 3.3 / 5 V. For the encoding of these lines and their associated voltages see TABLE 4-11. "PCCVCC(0:1) Encoding" on page 49.	0	R,W

TABLE 4-10. BCSR1 Description^a

<i>BIT</i>	<i>MNEMONIC</i>	<i>Function</i>	<i>PON DEF</i>	<i>ATT.</i>
10 - 11	PCCVPP(0:1)	PC Card VPP. These signals determine the voltage applied to the PCMCIA card's VPP. Possible values are 0 / 5 / 12 V. For the encoding of these lines and their associated voltages see TABLE 4-12. "PCCVPP(0:1) Encoding" on page 49.	'11'	R,W
12	Dram_Half_Word	Dram Half Word. When this bit is active (low) and the steps listed in 4-6-1 "DRAM 16 Bit Operation" on page 32 , are taken, the DRAM becomes 16 bit wide. When inactive the DRAM is 32 bit wide.	1	R,W
13	RS232EN_2	RS232 port 2 Enable. When asserted (low) the RS232 transceiver for port 2, is enabled. When negated, the RS232 transceiver for port 2, is in standby mode and the relevant MPC communication port pins are available for off-board use via the expansion connectors.	1	R,W
14	SDRAMEN	SDRAM Enable. When this bit is active (high), the SDRAM module is enabled on the local memory map. When in-active, the DRAM is place in low-power mode, in fact removed from the local memory map, allowing its associated CS line, to be used off-board via the expansion connectors.	1	R,W
15	PCCVCC1	Pc Card VCC Select 1. These signal in conjunction with PCCVCC0 determine the voltage applied to the PCMCIA card's VCC. Possible values are 0 / 3.3 / 5 V. For the encoding of these lines and their associated voltages see TABLE 4-11. "PCCVCC(0:1) Encoding" on page 49.	0	R,W
16 - 31	Reserved	Un-implemented	-	-

- a. Shaded areas are additions with respect to the MPC8XXFADS.
- b. In case a Single Bank DRAM SIMM is used CS3~ is free as well.
- c. Provided that this option is supported by the MPC by driving address lines low and asserting CS0~ during Hard-Reset.
- d. It is written in BCSR3.

TABLE 4-11. PCCVCC(0:1) Encoding

<i>PCCVCC(0:1)</i>	<i>PC-Card VCC [V]</i>
00	0
01	5
10	3.3
11	0

TABLE 4-12. PCCVPP(0:1) Encoding

<i>PCCVPP(0:1)</i>	<i>PC Card VPP [V]</i>
00	0

TABLE 4-12. PCCVPP(0:1) Encoding

<i>PCCVPP(0:1)</i>	<i>PC Card VPP [V]</i>
01	5
10	12 ^a
11	Hi-Z

a. Provided that a 12V power supply is applied.

4•11•4 BCSR2 - Board Control / Status Register - 2

BCSR2 is a status register which is accessed at offset 8 from the BCSR base address. Its a read only register which may be read at any time^A. BCSR2's various fields are described in [TABLE 4-13](#).

Freescale Semiconductor, Inc.

PRELIMINARY

A. Provided that BCSR is not disabled.

"BCSR2 Description" on page 51.

TABLE 4-13. BCSR2 Description^a

<i>BIT</i>	<i>MNEMONIC</i>	<i>Function</i>	<i>PON DEF</i>	<i>ATT.</i>
0 - 3	FLASH_PD(4:1)	Flash Presence Detect(4:1). These lines are connected to the Flash SIMM presence detect lines which encode the type of Flash SIMM mounted on the Flash SIMM socket. There are additional 3 presence detect lines which encode the SIMM's delay but appear in BCSR3. For the encoding of FLASH_PD(4:1) see TABLE 4-14. "Flash Presence Detect (4:1) Encoding" on page 51.	-	R
4	Reserved	Un-implemented	-	-
5 - 8	DRAM_PD(4:1)	Dram Presence Detect. These lines are connected to the DRAM SIMM presence detect lines which encode the size and the delay of the DRAM SIMM mounted on the DRAM SIMM socket. For the encoding of DRAM_PD(4:1) see TABLE 4-15. "DRAM Presence Detect (2:1) Encoding" on page 52 and TABLE 4-16. "DRAM Presence Detect (4:3) Encoding" on page 52.	-	R
9 - 12	EXTTOLI(0:3)	External Tools Identification. These lines, which are available at the expansion connectors over the daughter board, are intended to serve as tools' identifier or as S/W option selection. On board s/w may check these lines to detect The presence of various tools (h/w expansions) at the expansion connectors or the state of a dedicated 4 switches dip-switch which resides over the same lines or a combination of both. Half of the available combinations is reserved while the other half is available to users' applications. For the external tools' codes and their associated combinations see TABLE 4-17. "EXTTOOLI(0:3) Assignment" on page 52.	-	R
13 - 15	DBREVN(0:2)	Daughter Board Revision Number (0:2). This field represents the revision code, hard-assigned to each daughter board. This is a production revision which may be identical for different types of daughter boards. See TABLE 4-18. "MPC8XXFADS Daughter Boards' Revision Encoding" on page 53, for revisions' encoding.	-	R
13 - 31	Reserved	Un-implemented.	-	-

a. Shaded areas are additions with respect to the MPC812/860ADS.

TABLE 4-14. Flash Presence Detect (4:1) Encoding

<i>FLASH_PD(4:1)</i>	<i>FLASH TYPE / SIZE</i>
0 - 3	Reserved
4	SM732A2000 / SM73228 - 8 Mbyte SIMM, by SMART Modular Technologies.
5	SM732A1000A / SM73218 - 4 Mbyte SIMM, by SMART Modular Technologies.
6	MCM29080 - 8 MByte SIMM, by Motorola

TABLE 4-14. Flash Presence Detect (4:1) Encoding

<i>FLASH_PD(4:1)</i>	<i>FLASH TYPE / SIZE</i>
7	MCM29040 - 4 MByte SIMM, by Motorola
8	MCM29020 - 2 MByte SIMM, by Motorola
9 - F	Reserved

TABLE 4-15. DRAM Presence Detect (2:1) Encoding

<i>DRAM_PD(2:1)</i>	<i>DRAM TYPE / SIZE</i>
00	MCM36100 by Motorola or MT8D132X by Micron - 4 MByte SIMM
01	MCM36800 by Motorola or MT16D832X by Micron - 32 MByte SIMM
10	MCM36400 by Motorola or MT8D432X by Micron - 16 MByte SIMM
11	MCM36200 by Motorola or MT16D832X by Micron - 8 MByte SIMM

TABLE 4-16. DRAM Presence Detect (4:3) Encoding

<i>DRAM_PD(4:3)</i>	<i>DRAM DELAY</i>
00	Reserved
01	Reserved
10	70 nsec
11	60 nsec

TABLE 4-17. EXTTOOLI(0:3) Assignment

<i>EXTTOOLI(0:3)</i>	<i>External Tool</i>
0000-0111	Reserved
1000-1110	User Available
1111	Non Existent

WARNING

Since EXTOLI(0:3) lines may be DRIVEN LOW ('0') by the dip-switch, OFF-BOARD tools should NEVER DRIVE them HIGH. Failure in doing so, might result in PERMANENT DAMAGE to the FADS and / or to OFF-BOARD logic.

TABLE 4-18. MPC8XXFADS Daughter Boards' Revision Encoding

<i>Revision Number (0:3) [Hex]</i>	<i>MPC8XXFADS Daughter Board Revision</i>
0	ENG (Engineering)
1	PILOT
2 - 7	Reserved

4•11•5 BCSR3 - Board Control / Status Register 3

BCSR3 is an additional control / status register which may be accessed at offset 0xC from BCSR base address. BCSR3 gets its defaults during Power-On reset and may be read or written at any time.

PRELIMINARY

The description of BCSR3 is shown in [TABLE 4-19. "BCSR3 Description" on page 54.](#)

TABLE 4-19. BCSR3 Description

BIT	MNEMONIC	Function	PON DEF	ATT.
0 - 1	Reserved	Implemented	'00'	R
2 - 7	DBID(0:5)	Daughter Board ID. This field holds a code for the daughter board ID. Each Daughter board carries a unique ID code. For the specific daughter boards' codes see TABLE 4-20. "Daughter Boards' ID Codes" on page 54.	-	R
5 ^a	CNT_REG_EN_P ROTECT	Control Register Enable Protect. When this bit is active (low) the BCSR_EN bit in that register can not be written. When in-active, BCSR_EN may be written to remove the BCSR from the memory map. After any write to BCSR1 this bit becomes active again. This bit is a write-only bit on that register.	0	W
6 - 7	Reserved	Un-Implemented	-	-
8	BREVN0	Board Revision Number 0. This is the MS bit of the Board Revision Number. See TABLE 4-18. "MPC8XXFADS Daughter Boards' Revision Encoding" on page 53, for the interpretation of the Board Revision Number.	-	R
9 - 11	FLASH_PD(7:5)	Flash Presence Detect(7:5). These lines are connected to the Flash SIMM presence detect lines which encode the Delay of Flash SIMM mounted on the Flash SIMM socket - U15. There are additional 4 presence detect lines which encode the SIMM's Type but appear in BCSR2. For the encoding of FLASH_PD(7:5) see TABLE 4-22. "FLASH Presence Detect (7:5) Encoding" on page 55.	-	
12	BREVN1	Board Revision Number 1. Second bit of the Board Revision Number. See TABLE 4-18. "MPC8XXFADS Daughter Boards' Revision Encoding" on page 53, for the interpretation of the Board Revision Number.	-	R
13	Reserved	Implemented	'0'	R
14 - 15	BREVN(2:3)	Board Revision Number (2:3). The 2 LS bits of the Board Revision Number. See TABLE 4-18. "MPC8XXFADS Daughter Boards' Revision Encoding" on page 53, for the interpretation of the Board Revision Number.	-	R

a. This is a WRITE ONLY bit so it does not conflict with the DBID filed which is READ ONLY.

TABLE 4-20. Daughter Boards' ID Codes

DBID(0:5) [HEX]	MPC8XX On D/B
0	Reserved ^a .
1	MPC813 ^b

TABLE 4-20. Daughter Boards' ID Codes

<i>DBID(0:5) [HEX]</i>	<i>MPC8XX On D/B</i>
2	MPC821
3	MPC823
4 - 1F	Reserved
20	MPC801
21	MPC850 ^b
22	MPC860
23	MPC860SAR ^b
24	MPC860T ^b
25 - 3F	Reserved

- a. To distinguish between MPC8XXFADS and MPC8XXFADS
 b. Future 8XX Members

TABLE 4-21. MPC8XXFADS Revision Number Conversion Table

<i>Revision Number (0:3) [Hex]</i>	<i>MPC8XXFADS Revision</i>
0	ENG (Engineering)
1	PILOT
2 - F	Reserved

TABLE 4-22. FLASH Presence Detect (7:5) Encoding

<i>FLASH_PD(7:5)</i>	<i>Flash Delay [nsec]</i>
000	Not Supported
001	150
010	120
011	90
100 - 111	Not Supported

4•11•6 BCSR4 - Board Control / Status Register 4

The BCSR4 serves as a control register on the FADS. It is accessed at offset 10H from BCSR base address. It may be read or written at any time^A. BCSR4 gets its defaults upon Power-On reset. Most of BCSR4 pins are available at the daughter board connectors and on the expansion connectors

residing over the daughter boards, providing visibility towards daughter boards' and external logic. BCSR4 fields are described in [TABLE 4-23. "BCSR4 Description" on page 56.](#)

TABLE 4-23. BCSR4 Description^a

BIT	MNEMONIC	Function	PON DEF	ATT.
0	ETHLOOP	Ethernet port Diagnostic Loop-Back. When active (high), the MC68160 EEST is configured into diagnostic Loop-Back mode, where the transmit output is internally fed back into the receive section.	0	R,W
1	TFPLDL~	Twisted Pair Full-Duplex. When active (low), the MC68160 EEST is put into full-duplex mode, where, simultaneous receive and transmit are enabled.	1	R,W
2	TPSQEL~	Twisted Pair Signal Quality Error Test Enable. When active (low), a simulated collision state is generated within the EEST, so the collision detection circuitry within the EEST may be tested.	1	R,W
3	SIGNAL_LAMP	Signal Lamp. When this signal is active (low), a dedicated LED illuminates. When in-active, this led is darkened. This led is used for S/W signalling to user.	1	R,W
4	USB_EN ^b / UTOPIA_EN ^c / FETH_EN ^d	USB port Enable or Utopia Port Enable or Fast Ethernet Port Enable. When this signal is active (low) it enables the USB port transceiver in case an MPC823 daughter board is attached to the FADS or it enables the Utopia port in case an MPC860SAR daughter board is attached to the FADS or it enables the Fast Ethernet Port (100-Base-T) if an MPC860T daughter board is connected. This signal has no function with the MPC801, MPC821 and MPC860 daughter boards.	1	R,W
5	USB_SPEED	USB Port Speed. When this signal is active (high) the USB transceiver of the MPC823 daughter board is in full-speed mode. When inactive, the USB transceiver is in low-speed mode. This signal has no function with any daughter board other the MPC823 or MPC850 daughter boards.	1	R,W
6	USB_VCC0	USB Port VCC EN. When this signal is active (low), 5V power is enabled to the USB port. When inactive, power to the USB port is disconnected. This signal has no function with any daughter board other the MPC823 or MPC850 daughter boards.	1	R,W
7	Reserved.	Implemented.	0	R,W
8	VIDEO_ON	Video Port Enable. When this signal is active (low), the Video-On Led on the MPC823FADSDB is lit. When inactive, the led is darkened. This is merely an indication that should be set by application S/W to indicate activity of the Video Port, after it has been enabled via the I ² C port. This signal has no function with any daughter board other the MPC823 daughter board.	1	R,W

A. Provided that BCSR is not disabled.

TABLE 4-23. BCSR4 Description^a

BIT	MNEMONIC	Function	PON DEF	ATT.
9	VDO_EXT_CLK_EN	Video Port Clock Enable. When this signal is active (high), it enables an on-board 27MHz clock generator as a source for both the video encoder and the video port controller of the MPC823. The system programmer should avoid asserting this signal, until it is assured that the MPC823 is set to accept external video clock. Failure in doing so might result in permanent damage to the MPC823 and / or the on-board 27 MHz clock generator. This signal has no function with any daughter board other the MPC823 daughter board.	1	R,W
10	VIDEO_RST	Video Port Reset. when this active (low) signal is being ^e asserted, the Video Encoder, located on the MPC823FADSDB, is being reset. For further informations see 2•4 "VIDEO Support" on page 4 of the MPC823FADSDB spec. This signal has no function with any daughter board other the MPC823 daughter board	1	R,W
11	MODEM_EN	Modem Enable for MPC823. When this signal is active (low) while an MPC823FADSDB is connected to the FADS, it is possible to operate the MPC821 Modem Tool. This signal has no function with any other daughter board.	1	R,W
12	DATA_VOICE	Modem Tool Function Select. Effective only with MPC823AFDSDB. When This signal is high , the DATA function of the modem tool is selected. When low , the VOICE function of the modem tool is selected.	1	R,W
13 - 31	Reserved	Un-implemented	-	-

- a. Shaded areas are additions with respect to the MPC8XXFADS.
- b. MPC823 Daughter Board function.
- c. MPC860SAR Daughter Board function.
- d. MPC860T Daughter Board function.
- e. I.e., on the negative edge.

4•12 Debug Port Controller

The debug port of the MPC8XXFADS is implemented on-board, connected to the MPC via the JTAG^A port. Since the location^B of the debug port is determined via the Hard-Reset configuration, It is important that the relevant configuration bits (see 4•1•6 "Reset Configuration" on page 29) are not changed, if working with the local debug port is desired.

The debug port controller is interfaced to host computer via Motorola's ADI port, which is an 8-bit wide parallel port. Since the debug port is serial, conversion is done by hardware between the parallel and serial protocols.

The MPC's debug port is configured at SOFT-Reset to "Asynchronous Clock Mode" i.e., the debug port generates the debug clock - DSCK, which is asynchronous with the MPC system clock.

The debug port controller block diagram is shown in [FIGURE 4-7 "Debug Port Controller Block Diagram" on page 58.](#)

A. The debug port location is determined by the HARD - Reset configuration.

B. In terms of MPC pins.

FIGURE 4-7 Debug Port Controller Block Diagram



To allow for an external debug port controller to be incorporated with the FADS and to allow target system debug by the FADS, a standard 10 pin, debug port connector is provided and the local debug port controller may be disabled^A by removing the ADI bundle from the its connector.

When the ADI's 37 lead cable is disconnected from either the ADI connector or from the FADS's 37 pin connector, the debug port controller is disabled allowing either the connection of an external debug port controller, or independent s/w run, i.e., the MPC boots from the flash memory to run user's application without debug port controller intervention. This feature becomes especially handy regarding demo's.

In this state, VFLS(0:1) or FRZ^B signals are routed to the debug port connector, so that, the external debug port controller has run mode status information.

The ADI I/F supports upto 8 boards connected on the same bundle. Address selection is done by DS2 / 1,2,3. See 2•3•1 "ADI Port Address Selection" on page 7.

The debug port I/F has two registers: a control / status register and a data register. The control / status register hold I/F related control / status functions, while the data register serves as the parallel side of the Transmit / Receive shift register.

The control / status register is accessed when D_C~ bit is low while the data register is accessed when D_C~ is driven high by the host via the ADI port.

4•12•1 MPC8XXFADS As Debug Port Controller For Target System

The FADS may be used as a debug port controller for a target system, provided that the target system

A. I.e., debug port controller outputs are tri-stated, allowing debug port to be driven by an external debug-tool.
 B. Depended on H/W settings.

has a 10 pin header connector matching the one on the FADS.

In this mode of operation, the on-board debug port controller, is connected to the target system's debug-port connector (see [4•12•1•1 "Debug Port Connection - Target System Requirements" below](#)). Since DSDO signal is driven by the MPC, it is a must, to remove the local MPC from its socket, to avoid contention over this line.

When either the local MPC is removed from its socket or the daughter board is removed from the FADS, all FADS's modules are inaccessible, except for the debug-port controller. All module-enable indications are darkened, regardless of their associated enable bits in the BCSR. Pull-up resistors are connected to Chip-Select lines, so they do not float when the MPC is removed from its socket, avoiding possible contention over data-bus lines.

4•12•1•1 Debug Port Connection - Target System Requirements

In order for a target system may be connected to the FADS, as a debug port controller, few measures need to be taken on the target system:

- 1) A 10-pin header connector should be made available, with electrical connections matching [FIGURE 4-8 "Standard Debug Port Connector" on page 61](#).
- 2) Pull-down resistors, of app. 1K Ω should be connected over DSDI^A and DSCK^A signals. These resistors are to provide normal^B operation, when a debug-port controller, is not connected to the target system
- 3) The debug-port should be enabled and routed to the desired pins. See the DBGC and DBPC fields within the HARD-RESET configuration word.

4•12•2 Debug Port Control / Status Register

The control / status register is an 8 bit register (bit 7 stands for MSB). For the description of the ADI

A. Remember that the location of DSDI and DSCK is determined by the HARD-Reset configuration.

B. Normal - i.e., boot via CS0~.

control status register see [TABLE 4-24. "Debug Port Control / Status Register"](#) on page 60.

TABLE 4-24. Debug Port Control / Status Register

<i>BIT</i>	<i>MNEMONIC</i>	<i>Function</i>	<i>I/F Res et DEF</i>	<i>ATT.</i>
7	MpcRst	Mpc Reset. When this status only bit indicates when active (high) that either a SOFT or a HARD reset is driven by the MPC.	-	R
6	TxError	Transmit Error. When this status only bit is active (high) it indicates that the last transmission towards the MPC, was cut by an internal MPC8XX reset source. This bit is updated for each byte sent.	-	R
5	InDebug	In Debug Mode. When this status only bit is active (high) it indicates that the MPC is in debug mode ^a .	-	R
4 - 3	DebugClockFreq	Debug Clock Frequency Select. This field controls a frequency divider which divides DSCK. For the division factors and associated DSCK frequencies see TABLE 4-25. "DSCK Frequency Select" below.	'00'	R/W
2	StatusRequest	Status Request. When the host writes this bit active (low), the I/F will issue a status read request to the host by asserting ADS_REQ line to the host. When the host writes the control register with this bit negated, no status read request is issued. Upon I/F reset this bit wakes-up active.	0	R/W
1	DiagLoopBack	Diagnostic Loopback Mode. When this control bit is active (low) the I/F is placed in Diagnostic Loopback Mode. I.e., DSDI is connected internally to DSDO, DSDI is tri-stated, and each data byte sent to the I/F data register, is sampled back into the receive shift register. This mode allows for complete ADI I/F test, upto transmit and receive shift registers. Upon I/F reset this bit wakes-up active.	0	R/W
0	DebugEntry	Debug Mode Entry. When this bit is active (low), the MPC will enter debug mode instantly after SOFT reset. When inactive, the MPC will start executing normally and will enter debug mode only after exception. Upon I/F reset this bit wakes-up active.	0	R/W

a. Provided that the PCMCIA channel II pins are configured as debug pins - i.e, VFSL(0:1) signals are available. If not, the debug port can not be operated correctly.

TABLE 4-25. DSCK Frequency Select

<i>DebugClockFreq</i>	<i>DSCK Frequency [MHz]</i>
00	10
01	5
10	2.5
11	1.25

FIGURE 4-8 Standard Debug Port Connector

4•12•3 Standard MPCXXX Debug Port Connector Pin Description

The pins on the standard debug port connector are the maximal group needed to support debug port controllers for both the MPC5XX and MPC8XX families. Some of the pins are redundant for the MPC8XX family but are necessary for the MPC5XX family.

4•12•3•1 VFLS(0:1)

These pins indicate to the debug port controller whether or not the MPC is in debug mode. When both VFLS(0:1) are at '1', the MPC is in debug mode. These lines may serve alternate functions with the MPC, in which case FRZ needs to be selected, on either the FADS or target system^A.

4•12•3•2 HRESET*

This is the Hard-Reset bidirectional signal of the MPC. When this signal is asserted (low) the MPC enters hard reset sequence which includes hard reset configuration. This signal is made redundant with the MPC8XX debug port controller since there is a hard-reset command integrated within the debug port protocol. However, the local debug port controller uses this signal for compatibility with MPC5XX existing boards and s/w.

4•12•3•3 SRESET*

This is the Soft-Reset bidirectional signal of the MPC8XX. On the MPC5XX it is an output. The debug port configuration is sampled and determined on the rising-edge^B of SRESET* (for both processor families). On the MPC8XX it is a bidirectional signal which may be driven externally to generate soft reset sequence. This signal is in fact redundant regarding the MPC8XX debug port controller since there is a soft-reset command integrated within the debug port protocol. However, the local debug port controller uses this signal for compatibility with MPC5XX existing boards and s/w.

4•12•3•4 DSDI - Debug-port Serial Data In

Via the DSDI signal, the debug port controller sends its data to the MPC. The DSDI serves also a role during soft-reset configuration. (See 4•1•6•3 "Soft Reset Configuration" on page 29).

4•12•3•5 DSCK - Debug-port Serial Clock

During asynchronous clock mode, the serial data is clocked into the MPC according^C to the DSCK clock. The DSCK serves also a role during soft-reset configuration. (See 4•1•6•3 "Soft Reset Configuration" on page 29).

4•12•3•6 DSDO - Debug-port Serial Data Out

DSDO is clocked out by the MPC according to the debug port clock, in parallel^D with the DSDI being clocked in. The DSDO serves also as "READY" signal for the debug port controller to indicate that the debug port is ready to receive controller's command (or data).

- A. If a target system needs to use VFLS(0:1) alternate function, then, FRZ line should be connected to both VFLS(0:1) pins on the debug port connector.
- B. In fact that configuration is divided into 2 parts, the first is sampled 3 system clock cycles prior to the rising edge of SRESET* and the second is sampled 8 clocks after that edge.
- C. I.e., DSDI must meet setup / hold time to / from rising edge of the DSCK.
- D. I.e., full-duplex communication.

4•13 Power

There are 4 power buses with the MPC8XXs:

- 1) I/O
- 2) Internal Logic
- 3) Keep Alive
- 4) PLL

and there are 3 power buses on the MPC8XXFADS:

- 1) 5V bus
- 2) 3.3V bus
- 3) 12V bus

FIGURE 4-1 MPC8XXFADS Power Scheme



To support off-board application development, the power buses are connected to the expansion connectors, so that external logic may be powered directly from the board. The maximum current allowed to be drawn from the board on each bus is shown in [TABLE 4-26. "Off-board Application Maximum](#)

Current Consumption" below.

TABLE 4-26. Off-board Application Maximum Current Consumption

<i>Power BUS</i>	<i>Current</i>
5V	2A
3.3V	2A
2V	0.5A
12V	100 mA.

To protect on board devices against supply spikes, decoupling capacitors (typically 0.1 μ F) are provided between the devices' power leads and GND, located as close as possible to the power leads.

4•13•1 5V Bus

Some of the FADS peripherals reside on the 5V bus. Since the MPC is 5V friendly, it may operate with 5V levels on its lines with no damage. The 5V bus is connected to an external power connector via a fuse (5A).

To protect against reverse-voltage or over-voltage being applied to the 5V inputs a set of high-current diodes and zener diode is connected between the 5V bus and GND. When either over or reverse voltage is applied to the FADS, the protection logic will blow the fuse, while limiting the momentary effects on board.

4•13•2 3.3V Bus

The MPC itself as well as the SDRAM, the address and data buffers are powered by the 3.3^A bus, which is produced from the 5V bus using a special low-voltage drop, linear voltage regulator made by Micrel, the MIC29500-3.3BT which is capable of driving upto 5A, facilitating operation of external logic as well.

4•13•3 12V Bus

The sole purpose of the 12V bus is to supply VPP (programming voltage) for the PCMCIA card and for the Flash SIMM^B. It is connected to a dedicated input connector via a fuse (1A) and protected from over / reverse voltage application.

If the 12V supply is not required for either the PC-Card and for the flash SIMM, the 12V input to the FADS may be omitted.

A. At full speed. When lower performance is needed the internal logic may be powered from the 2V bus.
 B. If necessary.

5 - Support Information

In this chapter all information needed for support, maintenance and connectivity to the MPC8XXFADS is provided.

5•1 Interconnect Signals

The MPC8XXFADS interconnects with external devices via the following set of connectors:

- 1) P1 - ADI Port connector
- 2) PA2 - RS232 port 1
- 3) PB2 - RS232 port 2
- 4) P3 - Ethernet port
- 5) P4 - PCMCIA port
- 6) P5 - External Debug port controller input / output
- 7) P6 - 5V Power In
- 8) P7 - 12V Power In
- 9) P8 - Serial Ports' Expansion connector
- 10) PD1, PD2, PD3 & PD4 - Daughter-Board Connectors

5•1•1 P1 ADI - Port Connector

The ADI port connector - P1, is a 37-pin, Male, 90°, D-Type connector, signals of which are described in [TABLE 5-1 "P1 - ADI Port Interconnect Signals"](#) below:

TABLE 5-1 P1 - ADI Port Interconnect Signals

<i>Pin No.</i>	<i>Signal Name</i>	<i>Description</i>
1		Not connected with this application
2	D_C~	Data / Control selection. When '1', the debug port controller's data register is accessed, when '0' the debug port controller's control register is accessed.
3	HST_ACK	Host Acknowledge input signal from the host.
4	ADS_SRESET	When asserted ('1') and the FADS is selected by the host, generates Soft Reset to the MPC.
5	ADS_HRESET	When asserted ('1') and the FADS is selected by the host, generates Hard Reset to the MPC.
6	ADS_SEL2	ADI I/F address line 2 (MSB).
7	ADS_SEL1	ADI I/F address line 1.
8	ADS_SEL0	ADI I/F address line 0 (LSB).
9	HOST_REQ	HOST Request input signal from the host
10	ADS_REQ	ADS Request output signal from the MPC8XXFADS to the host
11	ADS_ACK	ADS Acknowledge output signal from the MPC8XXFADS to the host
12		Not connected with this application
13		Not connected with this application
14		Not connected with this application
15		Not connected with this application
16	PD1	Bit 1 of the ADI port data bus
17	PD3	Bit 3 of the ADI port data bus
18	PD5	Bit 5 of the ADI port data bus
19	PD7	Bit 7 of the ADI port data bus

TABLE 5-1 P1 - ADI Port Interconnect Signals

<i>Pin No.</i>	<i>Signal Name</i>	<i>Description</i>
20 - 25	GND	Ground.
26		Not connected with this application
27 - 29	HOST_VCC	HOST VCC input from the host. Used to qualify FADS selection by the host. When host is off, the debug port controller is disabled.
30	HOST_ENABLE~	HOST Enable input signal from the host. (Active low). Indicates that the host computer is connected to FADS. Used, in conjunction with HOST_VCC and ADS_SEL(2:0) to qualify FADS selection by the host.
31 - 33	GND	Ground.
34	PD0	Bit 0 of the ADI port data bus
35	PD2	Bit 2 of the ADI port data bus
36	PD4	Bit 4 of the ADI port data bus
37	PD6	Bit 6 of the ADI port data bus

5•1•2 PA2, PB2 - RS232 Ports' Connectors

The RS232 ports' connectors - PA2 and PB2 are 9 pin, 90°, female D-Type Stacked connectors, signals of which are presented in [TABLE 5-2. "PA2, PB2 Interconnect Signals"](#) below

TABLE 5-2. PA2, PB2 Interconnect Signals

<i>Pin No.</i>	<i>Signal Name</i>	<i>Description</i>
1	CD	Carrier Detect output from the MPC8XXFADS.
2	TX	Transmit Data output from the MPC8XXFADS.
3	RX	Receive Data input to the MPC8XXFADS.
4	DTR	Data Terminal Ready input to the MPC8XXFADS.
5	GND	Ground signal of the MPC8XXFADS.
6	DSR	Data Set Ready output from the MPC8XXFADS.
7	RTS (N.C.)	Request To Send. This line is not connected in the MPC8XXFADS.
8	CTS	Clear To Send output from the MPC8XXFADS.
9	-	Not connected

5•1•3 P3 - Ethernet Port Connector

The Ethernet connector on the MPC8XXFADS - P3, is a Twisted-Pair (10-Base-T) compatible connector. Use is done with 90°, 8-pin, RJ45 connector, signals of which are described in [TABLE 5-3. "P3 - Ethernet Port Interconnect Signals"](#) below.

TABLE 5-3. P3 - Ethernet Port Interconnect Signals

<i>Pin No.</i>	<i>Signal Name</i>	<i>Description</i>
1	TPTX	Twisted-Pair Transmit Data positive output from the MPC8XXFADS.
2	TPTX~	Twisted-Pair Transmit Data negative output from the MPC8XXFADS.

TABLE 5-3. P3 - Ethernet Port Interconnect Signals

<i>Pin No.</i>	<i>Signal Name</i>	<i>Description</i>
3	TPRX	Twisted-Pair Receive Data positive input to the MPC8XXFADS.
4	-	Not connected
5	-	Not connected
6	TPRX~	Twisted-Pair Receive Data negative input to the MPC8XXFADS.
7	-	Not connected
8	-	Not connected

5•1•4 PCMCIA Port Connector

The PCMCIA port connector - P4, is a 68 - pin, Male, 90°, PC Card type, signals of which are present in [TABLE 5-4. "P4 - PCMCIA Connector Interconnect Signals"](#) below

TABLE 5-4. P4 - PCMCIA Connector Interconnect Signals

<i>Pin No.</i>	<i>Signal Name</i>	<i>Attribute</i>	<i>Description</i>
1	GND		Ground.
2	PCCD3	I/O	PCMCIA Data line 3.
3	PCCD4	I/O	PCMCIA Data line 4.
4	PCCD5	I/O	PCMCIA Data line 5.
5	PCCD6	I/O	PCMCIA Data line 6.
6	PCCD7	I/O	PCMCIA Data line 7.
7	BCE1A~	O	PCMCIA Chip Enable 1. Active-low. Enables EVEN numbered address bytes.
8	PCCA10	O	PCMCIA Address line 10.
9	OE~	O	PCMCIA Output Enable signal. Active-low. Enables data outputs from PC-Card during memory read cycles.
10	PCCA11	O	PCMCIA Address line 11.
11	PCCA9	O	PCMCIA Address line 9.
12	PCCA8	O	PCMCIA Address line 8.
13	PCCA13	O	PCMCIA Address line 13.
14	PCCA14	O	PCMCIA Address line 14.
15	WE~/PGM~	O	PCMCIA Memory Write Strobe. Active-low. Strobes data to PC-Card during memory write cycles.
16	RDY	I	+Ready/-Busy signal from PC-Card. Allows PC-Card to stall access from the host, in case a previous access's processing is not completed.
17	PCCVCC	O	5V VCC for the PC-Card. Switched by the MPC8XXFADS, via BCSR1.

TABLE 5-4. P4 - PCMCIA Connector Interconnect Signals

<i>Pin No.</i>	<i>Signal Name</i>	<i>Attribute</i>	<i>Description</i>
18	PCCVPP	O	12V/5V VPP for the PC-Card programming. 12V available only if 12V is applied to P8. Controlled by the MPC8XXFADS, via BCSR1.
19	PCCA16	O	PCMCIA Address line 16.
20	PCCA15	O	PCMCIA Address line 15.
21	PCCA12	O	PCMCIA Address line 12.
22	PCCA7	O	PCMCIA Address line 7.
23	PCCA6	O	PCMCIA Address line 6.
24	PCCA5	O	PCMCIA Address line 5.
25	PCCA4	O	PCMCIA Address line 4.
26	PCCA3	O	PCMCIA Address line 3.
27	PCCA2	O	PCMCIA Address line 2.
28	PCCA1	O	PCMCIA Address line 1.
29	PCCA0	O	PCMCIA Address line 0.
30	PCCD0	I/O	PCMCIA Data line 0.
31	PCCD1	I/O	PCMCIA Data line 1.
32	PCCD2	I/O	PCMCIA Data line 2.
33	WP	I	Write Protect indication from the PC-Card.
34	GND		Ground
35	GND		Ground
36	CD1~	I	Card Detect 1~. Active-low. Indicates in conjunction with CD2~ that a PC-Card is placed correctly in socket.
37	PCCD11	I/O	PCMCIA Data line 11.
38	PCCD12	I/O	PCMCIA Data line 12.
39	PCCD13	I/O	PCMCIA Data line 13.
40	PCCD14	I/O	PCMCIA Data line 14.
41	PCCD15	I/O	PCMCIA Data line 15.
42	BCE2A~	O	PCMCIA Chip Enable 2. Active-low. Enables ODD numbered address bytes.
43	VS1	I	Voltage Sense 1 from PC-Card. Indicates in conjunction with VS2 the operation voltage for the PC-Card.
44	IORD~	O	I/O Read. Active-low. Drives data bus during I/O-Cards' read cycles.
45	IOWR~	O	I/O Write. Active-low. Strokes data to the PC-Card during I/O-Card write cycles.
46	PCCA17	O	PCMCIA Address line 17.

TABLE 5-4. P4 - PCMCIA Connector Interconnect Signals

<i>Pin No.</i>	<i>Signal Name</i>	<i>Attribute</i>	<i>Description</i>
47	PCCA18	O	PCMCIA Address line 18.
48	PCCA19	O	PCMCIA Address line 19.
49	PCCA20	O	PCMCIA Address line 20.
50	PCCA21	O	PCMCIA Address line 21.
51	PCCVCC	O	5V VCC for the PC-Card. Switched by the MPC8XXFADS, via BCSR1.
52	PCCVPP	O	12V/5V VPP for the PC-Card programming. 12V available only if 12V is applied to P8. Controlled by the MPC8XXFADS, via BCSR1.
53	PCCA22	O	PCMCIA Address line 22.
54	PCCA23	O	PCMCIA Address line 23.
55	PCCA24	O	PCMCIA Address line 24.
56	PCCA25	O	PCMCIA Address line 25.
57	VS2	I	Voltage Sense 2 from PC-Card. Indicates in conjunction with VS1 the operation voltage for the PC-Card.
58	RESET	O	Reset signal for PC-Card.
59	WAITA~	I	Cycle Wait from PC-Card. Active-low.
60	INPACK~	I	Input Port Acknowledge. Active-low. Indicates that the Pc-Card can respond to I/O access for a certain address.
61	PCREG~	O	Attribute Memory or I/O Space - Select. Active-low. Used to select either attribute (card-configuration) memory or I/O space.
62	BVD2	I	Battery Voltage Detect 2. Used in conjunction with BVD1 to indicate the condition of the PC-Card's battery.
63	BVD1	I	Battery Voltage Detect 1. Used in conjunction with BVD2 to indicate the condition of the PC-Card's battery.
64	PCCD8	I/O	PCMCIA Data line 8.
65	PCCD9	I/O	PCMCIA Data line 9.
66	PCCD10	I/O	PCMCIA Data line 10.
67	CD2~	I	Card Detect 2~. Active-low. Indicates in conjunction with CD1~ that a PC-Card is placed correctly in socket.
68	GND		Ground.

5•1•5 P5 - External Debug Port Controller Input Interconnect.

The debug port connector - P5, is a 10 pin, Male, header connector, signals of which are described

in TABLE 5-5. "P5 - Interconnect Signals" below

TABLE 5-5. P5 - Interconnect Signals

<i>Pin No.</i>	<i>Signal Name</i>	<i>Attribute</i>	<i>Description</i>
1	VFLS0	O	Visible history FLushes Status 0. Indicates in conjunction with VFLS1, the number of instructions flushed from the core's history buffer. Indicates also whether the MPC is in debug mode. If not using the debug port, may be configured for alternate function. When the FADS is disconnected from the ADI bundle, it may be FRZ signal, depended on J1's position.
2	SRESET~	I/O	Soft Reset line of the MPC. Active-low, Open-Drain.
3	GND		Ground.
4	DSCK	I/O	Debug Serial Clock. Over the rising edge of which serial date is sampled by the MPC from DSDI signal. Over the falling edge of which DSDI is driven towards the MPC and DSDO is driven by the MPC. Configured on the MPC's JTAG port. When the debug-port controller is on the local MPC or when the FADS is a debug-port controller for a target system - OUTPUT, when the FADI bundle is disconnected from the FADS - INPUT.
5	GND		Ground
6	VFLS1	O	See VFLS0. When the FADS is disconnected from the ADI bundle, it may be FRZ signal, depended on J1's position.
7	HRESET~	I/O	Hard Reset line of the MPC. Active-low, Open-Drain
8	DSDI	I/O	Debug Serial Data In of the debug port. Configured on the MPC's JTAG port. When the debug-port controller is on the local MPC or when the FADS is a debug-port controller for a target system - OUTPUT, when the ADI bundle is disconnected from the FADS - INPUT.
9	V3.3	O	3.3V Power indication. This line is merely for indication. No significant power may be drawn from this line.
10	DSDO	I/O	Debug Serial Data Output from the MPC. Configured on the MPC's JTAG port. When the debug-port controller is on the local MPC or when the ADI bundle is disconnected from the FADS - OUTPUT, when the FADS is a debug-port controller for a target system - INPUT.

5•1•6 P6 - 5V Power Connector

The 5V power connector - P6, is a 3-lead, two-part terminal block. The male part is soldered to the pcb, while the receptacle is connected to the power supply. That way fast connection / disconnection of power is facilitated and physical efforts are avoided on the solders, which therefore maintain solid connection over time.

TABLE 5-6. P6 - Interconnect Signals

<i>Pin Number</i>	<i>Signal Name</i>	<i>Description</i>
1	5V	5V input from external power supply.
2	GND	GND line from external power supply.

TABLE 5-6. P6 - Interconnect Signals

<i>Pin Number</i>	<i>Signal Name</i>	<i>Description</i>
3	GND	GND line from external power supply.

5•1•7 P7 - 12V Power Connector

The 12V power connector - P7, is a two-lead, 2 part, terminal block connector, identical in type to the 5V connector. P7 supplies, when necessary, programming voltage to the Flash SIMM and / or to the

TABLE 5-7. P7 - Interconnect Signals

<i>Pin Number</i>	<i>Signal Name</i>	<i>Description</i>
1	12V	12V input from external power supply.
2	GND	GND line from external power supply.

PCMCIA slot.

5•1•8 P8 - Serial Ports' Expansion Connector

P8 is the serial ports expansion connector. Its is compatible^A with the QUADS board and with the previous MPC8XXFADS.

P8 is a 96 pin, Female, DIN 41612 connector.

Since the pinout of P8 is specific to the Daughter-Board connected to the FADS, it is described in each Daughter-Board User's manual.

5•1•9 PD1, PD2, PD3 & PD4 - Daughter Boards' Connectors Interconnect Signals

To be described in the next edition of this document.

5•2 MPC8XXFADS Part List

In this section the MPC8XXFADS's bill of material is listed according to their reference designation.

To be added in the next edition of this document.

A. True for the MPC860, but true upto an extent for other derivatives.

APPENDIX A - Programmable Logic Equations

The MPC8XXFADS has 3 programmable logic devices on it. Use is done with MACH220-12 by AMD. These device support the following function on the FADS:

- 1) U7 - Debug Port Controller
- 2) U10 - auxiliary board control functions, e.g., buffers control, local interrupter, reset logic, etc'.
- 3) U11 - the BCSR.

PRELIMINARY

A•1 U2 - Debug Port Controller

```

*****
*****
"* MPC8XX FADS Debug Port Controller.                               *
"* Mach controller for an interface between Sun ADI port at one side, to *
"* debug port at the other.                                         *
*****
"* In this file (8):
"* - Added support for VFLS / FRZ switching, for both normal operation and
"*   external debug station connected to the FADS.
"*   Support includes:
"*   - separating vfls between MPC and debug port.
"*   - Selection between frz / vfls (default) is done by VflsFrz~ input pin.
"*   - Selection between on-board / off-board vfls/frz is done by Chins~ coming
"*     from the expansion connectors.
"*   - VFLS(0:1) are driven towards the debug-port connector when board is not
"*     selected, i.e., either ADI is disconnected or addresses don't match.
*****
"* In this file (7):
"* - BundleDelay field in the control register is changed to debug port
"*   clock frquency select according to the following values:
"*   0 - divide by 8 (1.25 Mhz)
"*   1 - divide by 4 (2.5 Mhz)
"*   2 - divide by 2 (5 Mhz)
"*   3 - divide by 1 (10 Mhz) default.
"* - Added clock divider for 2, 4, 8 output of which is routed externally
"*   to the i/f clock input.
*****
"* In this file (6):
"* - RUN siganl polarity was changed to active-high, this, to support
"*   other changes for revision PILOT of the fads.
*****
"* In this file (5) added:
"* - protection against spikes on the reset lines, so that the interface
"*   will not be reset by an accidental spike.
"* - D_C~ signal was synchronized to avoid accidental write to control
"*   during data write.
"* - DSDI is given value (H) prior to negation of SRESET* to comply with 5XX
"*   family
*****
"* In this file (4) the polarity of address selection lines is reversed so

```

Freescale Semiconductor, Inc.

```

AdsReq          PIN 2 ISTYPE 'reg, buffer';  "ADS to host, write
                "signal. (OUT,3s)

HstAck          PIN 54;          "Host to ADS, write ack.  (IN)

AdsHardReset   PIN 50;          "Host to ADS, Hard reset.  (IN)

AdsSoftReset   PIN 17;         "Host to ADS, Soft reset.  (IN)

HstEn~         PIN 3;          "Host connected to ADS.  (IN)

HostVcc        PIN 49;         "Host to ADS, host is on.  (IN)

D_C~           PIN 51;         "Host to ADS, select data
                "or control access.  (IN)

AdsSel0        PIN 22;
AdsSel1        PIN 21;
AdsSel2        PIN 9;  "Host to ADS, card addr.  (IN)

AdsAddr0       PIN 7;
AdsAddr1       PIN 6;
AdsAddr2       PIN 5;  "ADS board address switch. (IN)

AdsSelect~     NODE ISTYPE 'com, buffer'; "ADS selection indicator. (OUT)

*****
"* MPC pins. Including debug port.
*****

PdaHardReset~  PIN 40;          "Pda's hard reset input.  (I/O. o.d.)
PdaSoftReset~  PIN 65;          "Pda's soft reset output. (I/O. o.d.)
VFLS0          PIN 10 ;
VFLS1          PIN 11 ;          "Debug/Trap mode, report. (IN)
Freeze         PIN 24;          "Alternative debug mode report (IN)
DSCK           PIN 48 istype 'com'; "Pda's debug port clock. (Out)
DSDI           PIN 47 istype 'com'; "Pda's debug serial data in (Out)
DSDO           PIN 4;  " MPC8XX's debug serial data output (In)

*****
"* Dedicated Debug Port pins.
*****

```

Freescale Semiconductor, Inc.

```

VflsP0          PIN 38 istype 'com';
VflsP1          PIN 37 istype 'com';
VflsFrz~       PIN 13;          " selectes between VFLS/FRZ from MPC

```

```

*****
"* Mach to ADI data bus.                                     *
*****

```

```

PD7,
PD6,
PD5,
PD4,
PD3,
PD2,
PD1,
PD0 PIN 66,60,67,59,58,57,56,55; "ADI data bus.(I/O)

```

```

*****
"* Clock gen pins.                                         *
*****

```

```

DbgClk          PIN 16;          "Debug Clock input source. (IN)
DbgClkOut       PIN 33 istype 'com' ; " to be connected to IClk. (out)

```

```

Clk2           PIN 14 istype 'reg, buffer'; "IClk divided by 2 (Out)
              " (Out for testing, may be node)

```

```

IClk           PIN 15;          " Connected to Clkout externally (In)

```

```

*****
"* Misc.
*****

```

```

Run            PIN 23 istype 'com'; "external indication
ChinS~        PIN 12;          " active (L) when chips is In socket

```

```

*****
"*   ###                                     *
"*   #   #   #   #####   #####   #####   #   #   ##   #   #####   *
"*   #   ##   #   #   #   #   #   #   ##   #   #   #   #   #   #   *
"*   #   #   #   #   #   #####   #   #   #   #   #   #   #   #   #   *
"*   #   #   #   #   #   #   #   #   #   #   #   #   #   #   #   #   *
"*   #   #   ##   #   #   #   #   #   #   #   #   #   #   #   #   #   *

```

Freescale Semiconductor, Inc.





```

"*   ###   #   #   #   #####   #   #   #   #   #   #####   ####   *
*****
*****
"* Clock genrator Internals:
*****

DbgClkDivBy2   NODE istype 'reg, buffer';
DbgClkDivBy4   NODE istype 'reg, buffer';
DbgClkDivBy8   NODE istype 'reg, buffer'; " counter (divider) signals.

Cstr0          NODE istype 'reg, buffer';
Cstr1          NODE istype 'reg, buffer'; " Clock Safe Transition Register

*****
"* Reset active. (Active when at least one of the reset sources is active)   *
*****

PrimReset      NODE istype 'com';           " Primary Reset. Host initiated
D_PrimReset    NODE istype 'com';           " delayed Reset
DD_PrimReset   NODE istype 'com';           " double delayed primary reset.

Reset          NODE istype 'com';           " Interface reset.
PdaRst         NODE istype 'reg, buffer';   " MPC8XX continued / initiated.
              " part of the status register.

*****
"* ADS_ACK, ADS_REQ auxiliary internal control signals   *
*****

S_HstReqNODE  istype 'reg'; "sync. host req.
DS_HstReqNODE istype 'reg'; " double sync. host req.

S_D_C-NODE    istype 'reg, buffer'; " synchronized data/ control selection

S_HstAckNODE  istype 'reg, buffer'; " sync host ack
DS_HstAckNODE istype 'reg, buffer'; " double sync host ack

BundleDelay1,
BundleDelay0NODE istype 'reg, buffer'; "delay counter for bundle
              " delay compensation
BndTmrExpNODE istype 'com';" terminal count for bundle
              " delay timer.

PDOe NODE     istype 'com';           "Mach to ADI data OE.

```

Freescale Semiconductor, Inc.



PdaHardResetEnNODE istype 'com'; " enables hard reset buffer.

PdaSoftResetEnNODE istype 'com'; " enables soft reset buffer.

* Tx Shift Register *

TxReg7,

TxReg6,

TxReg5,

TxReg4,

TxReg3,

TxReg2,

TxReg1,

TxReg0NODE istype 'reg, buffer'; " Transmit latch and
" shift register

* Tx Control Logic *

TxWordLen3,

TxWordLen2,

TxWordLen1,

TxWordLen0NODE istype 'reg, buffer'; " Counter, counts (on fast clock,
" to gain 1/2 clock resolution)
" transmission length

TxWordEndNODE istype 'com'; " Terminal count, sets transmission
" length.

TxEn NODE istype 'reg, buffer'; " Transmit Enable.

TxCkSnsNODE istype 'reg, buffer'; " transmit clock polarity

* Rx Shift Register *

RxReg0NODE istype 'reg, buffer'; " receive shift register
" and latch

* Rx Control Logic *

DsdiEnNODE istype 'reg'; " enables dsdi towards

```

"* ADI control & status register bits.
*****
StatusRequest~    NODE istype 'reg, buffer';    "Status request
DebugEntry~      NODE istype 'reg, buffer';    "Debug enable after reset (L)
DiagLoopBack~   NODE istype 'reg, buffer';    "diagnostic loopback mode (L)
DbgClkDivSel0   NODE istype 'reg, buffer';
DbgClkDivSel1   NODE istype 'reg, buffer';    " DbgClk division select
InDebugMode     NODE istype 'reg, buffer';    " sync. VFLSs, became pin
TxError         NODE istype 'reg, buffer';    " tx interrupted by MPC8XX
                                           " internal reset.

```

```

*****
"* #####
"* # # ##### # # ##### ##### ## # # #####
"* # # # # # # # # # # # # # # # # #
"* # # # # # # # # # # # # # # # # # #
"* # # # # # # # # # # # # # # # # # #
"* # # # # # # # # # # # # # # # # # #
"* ##### ##### # # ##### # # # # # # #
"*
"* #####
"* # # ##### # # # # # # # # # # # # #
"* # # # # # # # # # # # # # # # # # #
"* # # ##### # # # # # # # # # # # # #

```

Freescale Semiconductor, Inc.

PRELIMINARY

```

"* # # # # ##### #####
"* # # # # # # # #
"* ##### ##### #### ##### # # # #
"*
"* ## ##### # #### # #
"* # # # # # # ## #
"* # # # # # # # # #
"* ##### # # # # # # #
"* # # # # # # # #
"* # # # # ##### # #
*****
H, L, X, Z = 1, 0, .X., .Z.;
C, D, U = .C., .D., .U.;

*****
"* Since all state machines operate at interface clock (IClk) there is no
"* need to have DbgClk driven during simulation (it will double the number
"* of vectors required). Therefore, an alternative clock generator was built
"* with which the 1/2 clock is the 1'st in the chain.
"* This alternative clock is compiled in if the SIMULATION variable is defined.
"* If not the original clock generator design is compiled, however simulation
"* will not pass then.
*****
"* SIMULATION = 1;
*****

*****
"* Signal groups
*****
AdsSel = [AdsSel2,AdsSel1,AdsSel0];
AdsAddr = [!AdsAddr2,!AdsAddr1,!AdsAddr0];

AdsRst = [AdsHardReset, AdsSoftReset];
Rst = [PdaHardReset~, PdaSoftReset~];

ClkOut = [Clk2];
DbgClkDiv = [DbgClkDivBy8, DbgClkDivBy4, DbgClkDivBy2];
DbgClkDivSel = [DbgClkDivSel1, DbgClkDivSel0];
Cstr = [Cstr1, Cstr0];

PD = [PD7,PD6,PD5,PD4,PD3,PD2,PD1,PD0];
VFLS = [VFLS0, VFLS1];

```



```

VflsP           = [VflsP0,VflsP1];
BndDly         = [BundleDelay1, BundleDelay0]; "bundle delay
               "compensation timer
TxReg          = [TxReg7..TxReg0];
RxReg          = [TxReg6,TxReg5,TxReg4,TxReg3,TxReg2,TxReg1,TxReg0,RxReg0];
AdiCtrlReg     = [DbgClkDivSel1, DbgClkDivSel0, StatusRequest~,
               DiagLoopBack~, DebugEntry~];
AdiStatReg     = [PdaRst, TxError, InDebugMode, DbgClkDivSel1, DbgClkDivSel0,
               StatusRequest~, DiagLoopBack~, DebugEntry~];
TxWordLen      = [TxWordLen3, TxWordLen2, TxWordLen1, TxWordLen0];
PortEn        = [AdsSel2,AdsSel1,AdsSel0,!AdsAddr2,!AdsAddr1,!AdsAddr0,
               HostVcc,HstEn~];

*****
"* Select Logic definitions
*****

HOST_VCC_ACTIVE = 1;
HOST_EN~_ACTIVE = 0;

HOST_IS_ON  = ((HstEn~==HOST_EN~_ACTIVE) & (HostVcc==HOST_VCC_ACTIVE));
HOST_IS_OFF = !HOST_IS_ON;

BOARD_IS_SELECTED = 0;
ADS_IS_SELECTED = (AdsSelect~.fb==BOARD_IS_SELECTED) ;

"Data_Cntrl~ line levels.
DATA      = 1;
CONTROL = !DATA;

*****
"* Reset Logic definitions
*****

ADS_HARD_RESET_ACTIVE      = 1;
ADS_SOFT_RESET_ACTIVE      = 1;

*****

"* Clock Logic definitions
*****

SELECT_CHANGE_ALLOWED = (DbgClkDiv.fb == 0);

DEBUG_CLOCK_DIV_BY_1 = (Cstr.fb == 0);
DEBUG_CLOCK_DIV_BY_2 = (Cstr.fb == 1);
DEBUG_CLOCK_DIV_BY_4 = (Cstr.fb == 2);

```

Freescale Semiconductor, Inc.

```
DEBUG_CLOCK_DIV_BY_8 = (Cstr.fb == 3);
```

```
*****
```

```
"* AdsAck Logic definitions
```

```
*****
```

```
BUNDLE_DELAY = 2;
```

```
HOST_REQ_ACTIVE = 1;
```

```
ADS_ACK_ACTIVE = 1; "The other state is - !ADS_ACK_ACTIVE
```

```
HOST_ACK_ACTIVE = 1;
```

```
HOST_WRITE_ADJ = ( (AdsSelect~.fb==BOARD_IS_SELECTED) &
                   (DS_HstReq.fb ==HOST_REQ_ACTIVE) &
                   (AdsAck==!ADS_ACK_ACTIVE) &
                   (HstAck==!HOST_ACK_ACTIVE) );
```

```
HOST_WRITE_ADJ_CONTROL = ( (AdsSelect~.fb==BOARD_IS_SELECTED) &
                            (DS_HstReq.fb ==HOST_REQ_ACTIVE) &
                            (AdsAck==!ADS_ACK_ACTIVE) &
                            (D_C~==CONTROL) &
                            (S_D_C~.fb == CONTROL) &
                            (HstAck==!HOST_ACK_ACTIVE) );
```

```
HOST_WRITE_ADJ_DATA = ( (AdsSelect~.fb==BOARD_IS_SELECTED) &
                        (DS_HstReq.fb==HOST_REQ_ACTIVE) &
                        (AdsAck==!ADS_ACK_ACTIVE) &
                        (D_C~==DATA) &
                        (S_D_C~.fb ==DATA) &
                        (HstAck==!HOST_ACK_ACTIVE) );
```

```
HOST_WRITE_COMPLETE = ( (AdsSelect~.fb==BOARD_IS_SELECTED) &
                          (DS_HstReq.fb==!HOST_REQ_ACTIVE) &
                          (AdsAck==!ADS_ACK_ACTIVE) );
```

```
*****
```

```
"* Control & Status register definitions
```

```
*****
```

```
STATUS_REQUEST= 0;
```

```
DEBUG_ENTRY= 0;
```

```
DIAG_LOOP_BACK= 0;
```

```
IN_DEBUG_MODE = 1;
```



```

TX_DONE_OK= 0;
TX_INTERRUPTED = !TX_DONE_OK;

FRZ_SELECTED = 0;

IS_STATUS_REQUEST = (StatusRequest~.fb == STATUS_REQUEST);
DEBUG_MODE_ENTRY = (DebugEntry~.fb == DEBUG_ENTRY);
IN_DIAG_LOOP_BACK = (DiagLoopBack~.fb == DIAG_LOOP_BACK);
IS_IN_DEBUG_MODE = (InDebugMode.fb == IN_DEBUG_MODE);
FRZ_IS_SELECTED = (VflsFrz~ == FRZ_SELECTED);

```

```

*****
* DSDI_ENABLE Logic definitions
*****

```

```

DSDI_ENABLED = 1;
DSDI_DISABLED = 0;

```

```

STATE_DSDI_ENABLED = (DsdEn.fb == DSDI_ENABLED);

```

```

*****
* Tx enable state machine
*****

```

```

TX_ENABLED = 1;
TX_DISABLED = 0;

```

```

STATE_TX_ENABLED = (TxEn.fb == TX_ENABLED);
STATE_TX_DISABLED = (TxEn.fb == TX_DISABLED);

```

```

TX_WORD_LENGTH = 14; " In 1/2 IClk clocks

```

```

*****
* TxClkSns state machine
*****

```

```

TX_ON_RISING = 0;
TX_ON_FALLING = 1;

```

```

STATE_TX_ON_RISING = (TxClkSns.fb == TX_ON_RISING);
STATE_TX_ON_FALLING = (TxClkSns.fb == TX_ON_FALLING);

```

```

*****
* AdsReq machine definitions.

```

Freescale Semiconductor, Inc.

```
ADS_REQ_ACTIVE = 1;      "The other state is - !ADS_REQ_ACTIVE
```

```
HOST_READ_ADI          = ( (AdsSelect~.fb==BOARD_IS_SELECTED) &
                           (DS_HstAck.fb==HOST_ACK_ACTIVE) &
                           (AdsReq==ADS_REQ_ACTIVE) &
                           (HstReq==!HOST_REQ_ACTIVE) );
```

```
HOST_READ_ADI_DATA     = ( (AdsSelect~.fb==BOARD_IS_SELECTED) &
                           (DS_HstAck.fb==HOST_ACK_ACTIVE) &
                           (HstReq==!HOST_REQ_ACTIVE) &
                           (AdsReq==ADS_REQ_ACTIVE) &
                           (D_C~==DATA) );
```

```
HOST_READ_ADI_CONTROL  = ( (AdsSelect~.fb==BOARD_IS_SELECTED) &
                           (DS_HstAck.fb==HOST_ACK_ACTIVE) &
                           (HstReq==!HOST_REQ_ACTIVE) &
                           (AdsReq==ADS_REQ_ACTIVE) &
                           (D_C~==CONTROL) );
```

```
ADS_SEND_STATUS        = ( (AdsSelect~.fb==BOARD_IS_SELECTED) &
                           (DS_HstReq.fb == !HOST_REQ_ACTIVE) &
                           (D_C~==CONTROL) &
                           (AdsAck==ADS_ACK_ACTIVE) &
                           IS_STATUS_REQUEST );
```

```
"* ADI Data Bus definitions
```

```
DATA_BUFFERS_ENABLE    = ( (AdsSelect~.fb==BOARD_IS_SELECTED) &
                           (HstAck==HOST_ACK_ACTIVE) &
                           (HstReq==!HOST_REQ_ACTIVE) );
```

```
STATUS_WORD_ON_ADI_BUS = ( (AdsSelect~.fb==BOARD_IS_SELECTED) &
                           (HstAck==HOST_ACK_ACTIVE) &
                           (HstReq==!HOST_REQ_ACTIVE) &
                           (D_C~==CONTROL) );
```

```
READ_DATA_WORD_ON_ADI_BUS = ( (AdsSelect~.fb==BOARD_IS_SELECTED) &
                               (HstAck==HOST_ACK_ACTIVE) &
                               (HstReq==!HOST_REQ_ACTIVE) &
                               (D_C~== DATA) );
```

```
"* Vfls / Frz select definitions
```



```

*****
CHIP_IN_SOCKET = 0;
CHIP_IS_IN_SOCKET = (ChinS~ == CHIP_IN_SOCKET);
*****

/* Equations, state diagrams.                                     *
*****

/*
/* #####
/* #      ##### # # ## ##### # ##### # # ##### *
/* #      # # # # # # # # # # # # # # # # # # # # *
/* ##### # # # # # # # # # # # # # # # # # # # # *
/* #      # # # # # ##### # # # # # # # # # # # # *
/* #      # # # # # # # # # # # # # # # # # # # # *
/* ##### # # # # # # # # # # # # # # # # # # # # *
/*
*****

*****

/* AdSelect.                                                    *
/* ADS selection indicator. At low state, when host accesses the ADS. *
*****

equations

!AdSelect~ = HOST_IS_ON & (AdSel==AdAddr); "AdAddr is already inverted

*****

/* Internal Logic Reset.
*****

equations

PrimReset = HOST_IS_OFF # "internal logic reset
              ( (AdsHardReset == ADS_HARD_RESET_ACTIVE) &
                (AdsSoftReset ==ADS_SOFT_RESET_ACTIVE) &
                ADS_IS_SELECTED );

D_PrimReset = PrimReset.fb;
DD_PrimReset = D_PrimReset.fb;

Reset = PrimReset.fb & D_PrimReset.fb & DD_PrimReset.fb;" spike filter

*****

```

Freescale Semiconductor, Inc.

```

"* Reset MPC8XX. (Connected to MPC8XX hard and reset inputs) Asynchronous.      *
*****
equations
    !PdaHardReset~ = H;
    PdaHardReset~.oe = PdaHardResetEn; "open-drain

    PdaHardResetEn = ADS_IS_SELECTED &
        (AdsHardReset==ADS_HARD_RESET_ACTIVE);
    !PdaSoftReset~ = H;

    PdaSoftReset~.oe = PdaSoftResetEn; "needs to be open-drain

    PdaSoftResetEn = ADS_IS_SELECTED &
        (AdsSoftReset==ADS_SOFT_RESET_ACTIVE );
*****
*****
"* Clock generator.
"* All i/f logic works on IClk, which is driven externally by the output
"* of DbgClk divider.
"* The debug clock divider is a 3 bit free-running counter, outputs of which
"* control a 4:1 mux, output of which drives IClk (externally).
"* Since mux control may change on the fly, a protection logic by means of
"* 2 bit register is provided, so that mux control is allowed to change
"* only when all divider outputs are high which assures a falling edge prior
"* to a rising edge.
"* Clk2 is infact the source for DSCK and is available outside for debug
"* purpose.
*****
equations
    DbgClkDiv.clk = DbgClk;

    DbgClkDiv := DbgClkDiv.fb + 1; " free running counter.

*****
"* Clock Safe Transition Register. (CSTR)
"* The goal of this register is to provide safe clock transitions, i.e., that
"* a transition will not cause races over the clockout. E.g., in a transition
"* between divide by 1 and divide by any bigger order, a possible race may
"* occur since the divided outputs are delayed with respect to DbgClk.
"* Therefore, a safe transition may be performed only when all clocks are LOW.
*****

```

Freescale Semiconductor, Inc.

equations

```
Cstr.clk = DbgClk;
"* Cstr.ar = Reset;
```

```
when (SELECT_CHANGE_ALLOWED) then
```

```
    Cstr := DbgClkDivSel.fb;
```

```
else
```

```
    Cstr := Cstr.fb;
```

```
*****
```

```
"* Clock selector.
```

```
"* Controlled by the CSTR.
```

```
*****
```

equations

```
DbgClkOut.oe = 1;
```

```
when (DEBUG_CLOCK_DIV_BY_1) then
```

```
    DbgClkOut = DbgClk;
```

```
else when (DEBUG_CLOCK_DIV_BY_2) then
```

```
    DbgClkOut = DbgClkDivBy2.fb;
```

```
else when (DEBUG_CLOCK_DIV_BY_4) then
```

```
    DbgClkOut = DbgClkDivBy4.fb;
```

```
else when (DEBUG_CLOCK_DIV_BY_8) then
```

```
    DbgClkOut = DbgClkDivBy8.fb;
```

```
*****
```

```
"* Clk2.
```

```
"* IClk divided by 2 .
```

```
*****
```

equations

```
    Clk2.clk = IClk;
```

```
    ClkOut.oe = 3;
```

```
    ClkOut.ar = Reset;
```

```
    Clk2 := !Clk2 & HOST_IS_ON;           "divide by 2
```

```
*****
```

```
"* Bundle delay timer. This timer ensures data validity in the following casses:
```

```
"* 1) Host write to adi. In that case AdsAck is ASSERTED only after that timer
```

```
"*    expired.
```



```

"* 2) Host read from adi. In that case AdsReq is NEGATED after that timer
"*   expired, ensuring enough time for data propagation over the bundle.
"* The timer is async reset when both soft and hard reset is applied to the i/f.
"* The timer is sync. reset a clock after it expires.
"* Count starts when either HstReq or HstAck are detected asserted
"* (after proper synchronization)
"* The value upon which the terminal count is asserted, is in the control
"* register. When the interface is reset by the host, this value defaults
"* to its upper bound. Using the diagnostic loop-back mode this value
"* may be re-established for optimal performance. (by means of test & error)
*****

```

equations

```

BndDly.ar = Reset;
BndDly.clk = IC1k;

```

```

when ( ( (HOST_WRITE_ADI_CONTROL # HOST_READ_ADI_CONTROL ) #
        (HOST_WRITE_ADI_DATA # HOST_READ_ADI_DATA) & !PdaRst.fb)
        & !BndTmrExp.fb) then
    BndDly := BndDly.fb +1;
else
    BndDly := 0;

```

```

BndTmrExp = (BndDly.fb == BUNDLE_DELAY) & !AdsAck ; "delay field
            "active low.

```

```

"* AdsAck.
"* Host write to ads ack. This state machine generates an automatic ADS_ACK,
"* during a host to ADS write.
"* When the host access the ADS data / control register, an automatic
"* acknowledge is generated, after data has been latched into either the
"* tx shift register or the control register.
"* Acknowledge is released when the host removes its write control line.
"* (HstReq)
"*
"* The machine steps through these states :
"* 0 - !ADS_ACK_ACTIVE
"* 1 - ADS_ACK_ACTIVE

```

equations

```

AdsAck.clk = IC1k;

```

```

AdsAck.ar    = Reset;
AdsAck.oe    = ADS_IS_SELECTED;
S_HstReq.clk = IClk;
DS_HstReq.clk = IClk;

S_HstReq := HstReq;
DS_HstReq := S_HstReq.fb & HstReq;"double synced

S_D_C~.clk = IClk;" synchronizing D_C~ selector
S_D_C~ := D_C~;
state_diagram AdsAck
state !ADS_ACK_ACTIVE:
    if ( (HOST_WRITE_ADI_CONTROL #
        (HOST_WRITE_ADI_DATA & !PdaRst.fb) ) & BndTmrExp.fb) then
        ADS_ACK_ACTIVE
    else
        !ADS_ACK_ACTIVE;

state ADS_ACK_ACTIVE:
    if ( DS_HstReq.fb==!HOST_REQ_ACTIVE ) then
        !ADS_ACK_ACTIVE
    else
        ADS_ACK_ACTIVE;
*****
/* Transmit Enable logic.
/* Enables transmit of serial data over DSDI and generation of serial
/* clock over DSCK.
/* Transmission begins immediately after data written by the host is latched
/* into the transmit shift register and ends after 7 shifts were made to the
/* tx shift register.
/* Termination is done using a 4 bit counter TxWordLength which has a terminal
/* count (and reset) TxWordEnd.
*****
equations

TxEn.ar = Reset;
TxEn.clk = IClk;" to provide 1/2 clock resolution

state_diagram TxEn
state TX_DISABLED:
    if(HOST_WRITE_ADI_DATA & BndTmrExp.fb & !PdaRst.fb) then
        TX_ENABLED

```

Freescale Semiconductor, Inc.

```

else
    TX_DISABLED;
state TX_ENABLED:
    if(TxWordEnd # PdaRst.fb) then
        TX_DISABLED
    else
        TX_ENABLED;
*****
"* Transmit Length Counter. This counter determines the length of transmission
"* towards the MPC. The fast clock is used here to allow 1/2 clock resolution
"* with the negation of TxEn, which enables DSCK outside.
*****
equations
TxWordLen.ar = Reset;
TxWordLen.clk = IClk;

TxWordEnd = (TxWordLen.fb == TX_WORD_LENGTH);

when ( STATE_TX_ENABLED & !TxWordEnd & !PdaRst.fb) then
    TxWordLen.d = TxWordLen.fb + 1;
else
    TxWordLen.d = 0;

*****
"* TxClkSns - Transmit Clock Sense.
"* Since Host req is synced acc to IClk and may be detected active when Clk2 is
"* either '1' or '0', DSCK and the clock according to which DSDI is sent and
"* DSDO is sampled should be changed.
"* When TxClkSns is '0' - DSCK will be !Clk2 while transmit will be done
"* according to Clk2 and recieve by !Clk2.
"* When TxClkSns is '1' - DSCK will be Clk2 while transmit will be done
"* according to !Clk2~ and recieve by Clk2.
*****
equations

TxClkSns.clk = IClk;
TxClkSns.ar = Reset;

state_diagram TxClkSns

state TX_ON_RISING:
    if (HOST_WRITE_ADI_DATA & BndTmrExp.fb & Clk2) then

```



```

        TX_ON_FALLING
    else
        TX_ON_RISING;
state TX_ON_FALLING:
    if (HOST_WRITE_ADI_DATA & BndTmrExp.fb & !Clk2) then
        TX_ON_RISING
    else
        TX_ON_FALLING;
        *****
** Tx shift Register.
** 8 bits shift register which either shifts data out (MSB first) or holds
** its data. The edge (in Clk2 terms) upon which the above actions are taken,
** is determined by TxClkSns. The Tx shift register operates according to IClk.
** The Tx shift register is 1'st written by the host (data cycle) and along
** with write being acknowledged to the host data is shifted out via DSDI.
**
** In order of saving logic, the Tx shift register is shared with the Receive
** shift register, this, due to the fact that when a bit is shifted out a FF
** becomes available. Since the Tx shift register is shifted MSB first, its
** LSB FFs are gradually becoming available for received data.
** To provide a 1/2 DACK hold time for DSDI, a single FF receive SR is used
** which is the source for the Tx shift register. (if 0 hold is required
** for DSDI this FF may be omitted)
        *****
equations

TxReg.clk = IClk;
TxReg.ar = Reset;

when ( HOST_WRITE_ADI_DATA & BndTmrExp.fb & !STATE_TX_ENABLED) then
    [TxReg7..TxReg1] := [PD7..PD1].pin;    " latching ADI data
else when (STATE_TX_ENABLED & STATE_TX_ON_RISING & !Clk2 #
    STATE_TX_ENABLED & STATE_TX_ON_FALLING & Clk2) then
    [TxReg7..TxReg1] := [TxReg6..TxReg0].fb;    " shifting out MSB 1'st.
else
    [TxReg7..TxReg1] := [TxReg7..TxReg1].fb;    " Holding value.

when ( HOST_WRITE_ADI_DATA & BndTmrExp.fb & !STATE_TX_ENABLED) then
    TxReg0 := PD0.pin;
else when (STATE_TX_ENABLED & STATE_TX_ON_RISING & !Clk2 #
    STATE_TX_ENABLED & STATE_TX_ON_FALLING & Clk2) then

```

Freescale Semiconductor, Inc.



```
TxReg0 := RxReg0.fb;
else
TxReg0 := TxReg0.fb;
```

```
"* Receive Shift Register.
"* A single stage shift register used as a source for the Tx shift register.
"* In normal mode the input for the Rx shift register is the MPC8XX's DSDO, while
"* in diagnostic loopback mode, data is taken directly from the Tx shift
"* serial output.
"*
"* The output of the Rx shift register is fed to the input of the Tx shift
"* register. When transmission (and reception) is done the received data
"* word is composed of the Rx shift register (LSB) concatenated with the
"* 7 LSBs of the Tx shift register.
"*
"* The edge (in Clk2 terms) upon which data is shifted in is determined by
"* TxClkSns as with the Tx shift register but on opposite edges, i.e.,
"* data is shifted Out from the Tx shift register on the Falling edge of
"* DSCK while is shifted In to the Rx shift register on the Rising edge
"* DSCK. (DSCK terms are constant in that regard).
```

equations

```
RxReg0.clk = IClk;
RxReg0.ar = Reset;

when ( STATE_TX_ENABLED & STATE_TX_ON_RISING & Clk2 #
STATE_TX_ENABLED & STATE_TX_ON_FALLING & !Clk2) & (!IN_DIAG_LOOP_BACK) then
RxReg0.d = DSDO; "shift in ext data
else when ( STATE_TX_ENABLED & STATE_TX_ON_RISING & Clk2 #
STATE_TX_ENABLED & STATE_TX_ON_FALLING & !Clk2) & IN_DIAG_LOOP_BACK then
RxReg0.d = TxReg7.fb;" shift in from transmit reg
else
RxReg0.d = RxReg0.fb;" hold value
```

```
"* AdsReq.
"* Host from ads, read acknowledge. This state machine generates an automatic
"* ADS read request from the host when either a byte of data is received in the
```

Freescale Semiconductor, Inc.

```

"* Rx shift register or the status request bit in the control register is
"* active during a previous host write to the control register.
"* When the host detects AdsReq asserted, it asserts HstAck in return. HstAck
"* double synchronized from the ADI port and delayed using the bundle delay
"* compensation timer to negate AdsReq. When the host detects AdsReq negated
"* it knows that data is valid to be read. After the host reads the data it
"* negates HstAck.
"* The machine steps through these states :
"* 0 - !ADS_REQ_ACTIVE
"* 1 - ADS_REQ_ACTIVE
*****

```

equations

```

AdsReq.clk = IClk;
AdsReq.ar = Reset;
AdsReq.oe = ADS_IS_SELECTED;

S_HstAck.clk = IClk;
DS_HstAck.clk = IClk;

S_HstAck := HstAck;
DS_HstAck := HstAck & S_HstAck;"double synced

```

state_diagram AdsReq

```

state !ADS_REQ_ACTIVE:
  if ( TxEn.fb & TxWordEnd #" end of data shift to MPC8XX
      ADS_SEND_STATUS) then" end of control write and status required
    ADS_REQ_ACTIVE
  else
    !ADS_REQ_ACTIVE;

state ADS_REQ_ACTIVE:
  if ( HOST_READ_ADI & BndTmrExp.fb ) then
    !ADS_REQ_ACTIVE
  else
    ADS_REQ_ACTIVE;

```

```

*****
"* ADI control register.
"* The ADI control register is written upon host to ADI write with a
"* D_C~ line is in control mode. It also may be read when StatusRequest~ bit
"* is active.
"*

```

Freescale Semiconductor, Inc.

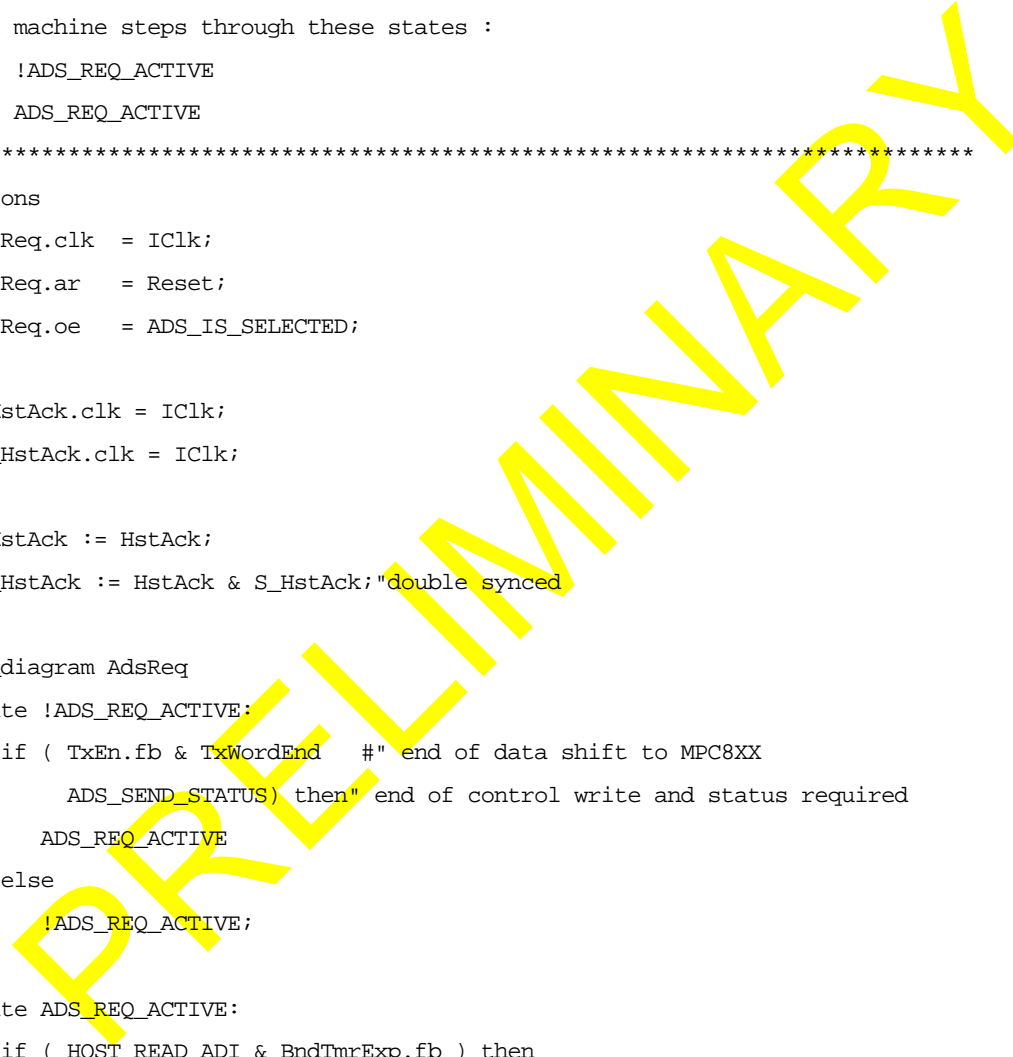

```

"* Control register bits description:
"*
"* DebugEntry~: (Bit 0). When this bit is active (L), the MPC8XX will enter debug
"* mode immediately after reset, i.e., DSCK will be held high
"* after the rising edge of SRESET*. When negated, DSCK will be
"* held low after the rising edge of SRESET so the MPC8XX will start
"* running instantly.
"* DiagLoopBack~: (Bit 1). When active (L), the interface is in Diagnostic
"* Loopback mode. I.e., the source for the Rx shift register is
"* the output of the Tx shift register. During that mode, DSCK
"* and DSDI are tri-stated, so no arbitrary data is sent to the
"* debug port. When inactive, the interface is in normal mode,
"* i.e., DSCK and DSDI are driven and the source of the Rx shift
"* register is DSDO.
"* StatusRequest~: (Bit 2). When active (L) any write to the control register
"* will be followed by a status read cycle initiated by the
"* debug port controller, i.e., AdsReq will be asserted after
"* the write cycle ends. When inactive, a write to the control
"* register will not be followed by a read from status register.
"* DbgClkDivSel(1:0) : (Bits 4,3). This field selects the division of the
"*          DbgClk input. Division factors are set as follows:
"*          0 - by 1
"*          1 - by 2
"*          2 - by 4
"*          3 - by 8
"*
"* Important!!! All bits wake up active (L) after reset.
"*
"*****
equations
    AdiCtrlReg.clk = IClk;
    AdiCtrlReg.ar = Reset;"All active low.

when ( HOST_WRITE_ADI_CONTROL & BndTmrExp.fb) then
    AdiCtrlReg.d = [PD4.pin, PD3.pin, PD2.pin, PD1.pin, PD0.pin];
else
    AdiCtrlReg.d = AdiCtrlReg.fb;

"*****

"* ADI Data Bus.
"* The Adi data bus is driven towards the host when the host reads the i/f.

```

Freescale Semiconductor, Inc.

PRELIMINARY

```

"* When D_C~ line is high (data) the Rx shift register contents is driven. If
"* D_C~ is low (control) the status register contents is driven.
"* The status register contains all control register's bits (4:0) with the
"* addition of the following:
"*
"* InDebugMode: (Bit 5). When this bit is active (H), the mpc is in debug mode,
"* i.e., either Freeze or VFLS(0:1) lines are driven high.
"*     When mpc is not in socket, VflsP(0:1) coming from the debug port
"*     are selected.
"* TxError: (Bit 6). When this bit is active (H), it signals that the MPC8XX was
"* reset (internally) during data transmission. (i.e., data received
"* during that transmission is corrupted). This bit is reset (L) when
"* either happens: (1) - The interface is reset by the host (both
"* AdsHardReset and AdsSoftReset are asserted (H) by the host
"* while the board is selected). (2) - The host writes the interface with
"* D_C~ signal low (control) and with data bit 6 high. (3) - a new data
"* word is written to the Tx shift register. (I.e., error is not kept
"* indefinitely).
"* PdaRst: (Bit 7). When this bit is active (H), it means that either SRESET*
"* or HRESET* or both are driven by the MPC8XX. The host have to wait until
"* this bit negates so that data may be written to the debug port.
*****
equations
    PDoe = DATA_BUFFERS_ENABLE ;

    PD.oe = PDoe;

    when ( READ_DATA_WORD_ON_ADI_BUS) then
        PD = RxReg.fb;
    elseif ( STATUS_WORD_ON_ADI_BUS ) then
        PD = [PdaRst.fb, TxError.fb, InDebugMode.fb, DbgClkDivSel1.fb, DbgClkDivSel0.fb,
            StatusRequest~.fb, DiagLoopBack~.fb, DebugEntry~.fb ];

*****
"* Reset Status
*****

    PdaRst.clk = IClk;

    PdaRst := (!PdaHardReset~ # !PdaSoftReset~) &
              (AdsSelect~.fb==BOARD_IS_SELECTED);    " synchronized inside.

*****

```

Freescale Semiconductor, Inc.

```

"* In debug Mode
*****

InDebugMode.clk = IClk;

when (FRZ_IS_SELECTED & CHIP_IS_IN_SOCKET) then
    InDebugMode := Freeze;
else when (!FRZ_IS_SELECTED & CHIP_IS_IN_SOCKET) then
    InDebugMode := (VFLS0 & VFLS1);
else when (!CHIP_IN_SOCKET) then
    InDebugMode := (VflsP0.pin & VflsP1.pin);

*****

"* TxError.
"* This bit of the status register is set ('1') when the MPC8XX internally resets
"* during data transmission over the debug port.
"* When this bit is written '1' by the adi port (control) the status bit is
"* cleared. Writing '0' has no influence on that bit.
*****

equations

TxError.clk = IClk;
TxError.ar = Reset;

state_diagram TxError

state TX_DONE_OK:
    if (STATE_TX_ENABLED & PdaRst.fb) then
        TX_INTERRUPTED
    else
        TX_DONE_OK;

state TX_INTERRUPTED:
    if (HOST_WRITE_ADI_CONTROL & BndTmrExp.fb & PD6.pin
        # HOST_WRITE_ADI_DATA & BndTmrExp.fb & !PdaRst.fb) then
        TX_DONE_OK
    else
        TX_INTERRUPTED;

*****

"* DSCK.
"* MPC8XX debug port, gated serial clock.

```

Freescale Semiconductor, Inc.



```
*****
equations
  Dsck.Oe = ADS_IS_SELECTED;

  when ( ADS_IS_SELECTED & !PdaSoftReset~ ) then
    Dsck = H;"debug mode enable
  else when ( ADS_IS_SELECTED & !TxEn.fb & PdaSoftReset~ ) then
    Dsck = !DebugEntry~.fb;"debug mode direct entry
  else when (ADS_IS_SELECTED & TxEn.fb & STATE_TX_ON_RISING) then
    Dsck = !Clk2;"debug port clock
  else when (ADS_IS_SELECTED & TxEn.fb & STATE_TX_ON_FALLING) then
    Dsck = Clk2;"debug port inverted clock
  else when (!ADS_IS_SELECTED) then
    Dsck = H;"default value, infact X

*****
/* DSDI.
/* Debug Port Serial Data in. (from MPC8XX).
/* To provide better hold time for DSDI from the last rising edge of Dsck,
/* a dedicated enable for DSDI is provided - DSDI_ENABLE.
*****
equations
  DsdiEn.ar = Reset;
  DsdiEn.clk = IClk;

state_diagram DsdiEn
  state DSDI_DISABLED;
    if(HOST_WRITE_ADI_DATA & BndTmrExp.fb & !PdaRst.fb) then
      DSDI_ENABLED
    else
      DSDI_DISABLED;
  state DSDI_ENABLED:
    if(STATE_TX_DISABLED # PdaRst.fb) then
      DSDI_DISABLED
    else
      DSDI_ENABLED;

equations
  DSDI.Oe = ADS_IS_SELECTED & !IN_DIAG_LOOP_BACK; "avoid junk driven on DSDI input
    "during diagnostic loop back mode.

  when (ADS_IS_SELECTED & !PdaSoftReset~) then
    DSDI = H;

  else when (ADS_IS_SELECTED & !STATE_DSDI_ENABLED & PdaSoftReset~ ) then
```

```
DSDI = L;
else when (ADS_IS_SELECTED & STATE_DSDI_ENABLED) then
  DSDI = TxReg7.fb;
else
  DSDI = L;

*****
"* Debug Port VFLS pins.
*****

equations

VflsP.oe = !ADS_IS_SELECTED;

when (!FRZ_IS_SELECTED) then
  VflsP = [VFLS0,VFLS1];
else when (FRZ_IS_SELECTED) then
  VflsP = [Freeze,Freeze];

*****
"* Run Led
*****

Run.oe = H;
!Run = IS_IN_DEBUG_MODE;"when 1 lits a led.

end dbg_prt7
```

PRELIMINARY

Freescale Semiconductor, Inc.

A•2 U11 - Board Control & Status Register

```

*****
** In this file (6):
** - Added board revision # at BCSR3: 0 ENG
**       1 - PILOT.
** - Flash Presence detect lines - added FlashPD(7:5).
** - Changed polarity of Power-On Reset (now active high)
** - DramEn becomes active-low to enhance debug-station support changes.
*****
** In this file (7):
** - Board revisiob code @ BCSR3 is changed to 2 - Rev A.
*****
** In this file (8):
** - Board revisiob code @ BCSR3 is changed to 3 - Rev B.
** - Added RS232En2~ for 2'nd RS232 port.
*****
** In this file (9):
** - All status bits (except CntRegEnProtect~) are removed for external buffers.
** - Added address line A27
** - Added BCSR2CS~ and BCSR3CS~ for external status registers.
** - Added controls on bcsr1:
**   - SdramEn~
**   - PccVcc1~
** - Added BCSR4 with following controls:
**   - UsbUtpFethEn~ (bit 0) enables Usb or Utopia or Fast Ethernet ports
**   - UsbSpeed (bit 1) Usb speed control ('1'- full speed)
**   - UsbVcc0(bit 2) enables VCC for Usb channel
**   - UsbVcc1 (bit 3) reserved for possible 3.3V usb power
**   - VideoOn~(bit 4) enables video transceiver
**   - VideoExtClkEn (bit 5) enables ext 27Mhz clock for video encoder
**   - VideoRst~(bit 6) resets the video encoder.
**   - Signalamp(bit 7) used for s/w signaling to user.
*****
** In this file (10):
** - Added ethernet transceiver control signals to BCSR4:
**   - EthLoop (bit 8) sets the transceiver to internal loopback (H)
**   - TPFFLDL~ (bit 9) sets the trans. to full-duplex mode. (L)
**   - TPSQEL~ (bit 10) allows for testing the colission circuitry
**             of the 68160.
**   - ModemEne~ (bit 11) enables the modem tool with the MPC823FADSDB
**   - Modem_Audio~ (bit 12) selects between modem / audio function for

```

Freescale Semiconductor, Inc.

```

**                                  modem tool with MPC823 daughter board.
*****

module bcsr10
title 'MPC8XXFADS Board Control and Status Register'

*****
** Device declaration.
*****

U11 device 'mach220a';

*****
** #####           *
** #           #   #   #####   #####   #   #   ##   #   #####   *
** #           #   #   #   #   #   #   #   #   #   #   #   #   #   *
** #####       ##   #   #####   #   #   #   #   #   #   #   #   *
** #           ##   #   #   #####   #   #   #   #####   #   #   *
** #           #   #   #   #   #   #   #   #   #   #   #   #   #   *
** #####      #   #   #   #####   #   #   #   #   #   #   #   #   *
*****

*****
** Pins declaration.
*****

** System i/f pins
*****

SYSCLKPIN 15;

RGPORInPIN 54;
ResetConf~PIN 45;

BrdContRegCs~PIN 49;

TA~ PIN 16;
R_W~ PIN 50;

A27 PIN 17;
A28 PIN 20;
A29 PIN 51;

D0 PIN 10;

```



D1 PIN 11;
 D2 PIN 12;
 D3 PIN 13;
 D4 PIN 33;
 D5 PIN 14;
 D6 PIN 25;
 D7 PIN 24;
 D8 PIN 23;
 D9 PIN 22;
 D10 PIN 21;
 D11 PIN 29;
 D12 PIN 30;
 D13 PIN 31;
 D14 PIN 32;
 D15 PIN 9;

```

*****
"* Board Control Pins. Read/Write.
*****
FlashEn~PIN 62 istype 'reg,buffer'; " flash enable.
DramEn~PIN 7 istype 'reg,buffer'; " dram enable
EthEn~PIN 6 istype 'reg,buffer'; " ethernet port enable
InfRedEn~PIN 41 istype 'reg,buffer'; " infra-red port enable
FlashCfgEn~PIN 37 istype 'reg,buffer'; " flash configuration enable
CntRegEn~PIN 36 istype 'reg,buffer'; " control register access enable
RS232En1~PIN 63 istype 'reg,buffer'; " RS232 port 1 enable
PccEn~PIN 40 istype 'reg,buffer'; " PCMCIA port enable
PccVcc0PIN 65 istype 'reg,buffer'; " PCMCIA operation voltage select 0
PccVpp0PIN 59 istype 'reg,buffer'; " PCMCIA programming voltage select
PccVpp1PIN 66 istype 'reg,buffer'; " PCMCIA programming voltage select
HalfWord~PIN 58 istype 'reg,buffer'; " 32/16 bit dram operation select
RS232En2~PIN 64 istype 'reg,buffer'; " RS232 port 2 enable
SdramEn~PIN 56 istype 'reg,buffer'; " sdram enable
PccVcc1PIN 57 istype 'reg,buffer'; " PCMCIA operation voltage select 1

EthLoop PIN 60 istype 'reg,buffer'; " 68160 internal loop back
TPFLDL~ PIN 43 istype 'reg,buffer'; " 68160 full-duplex
TPSQEL~ PIN 44 istype 'reg,buffer'; " 68160 colission circuitry test.
SignalLamp~PIN 4 istype 'reg,buffer'; " status lamp for misc s/w visual signaling
UsbUtpFethEn~ PIN 67 istype 'reg,buffer'; " Usb or Utopia or Fast ethernet port enable
UsbSpeedPIN 46 istype 'reg,buffer'; " Usb speed control
UsbVcc0PIN 3 istype 'reg,buffer'; " Usb VCC select 0 line

```

Freescale Semiconductor, Inc.



```

UsbVcc1PIN 2 istype 'reg,buffer'; " Usb VCC select 1 line
VideoOn~PIN 39 istype 'reg,buffer'; " Video encoder enable
VideoExtClkEn PIN 38 istype 'reg,buffer'; " Enable external clock gen for video encoder
VideoRst~PIN 5 istype 'reg,buffer'; " Video Encoder reset
ModemEn~ PIN 28 istype 'reg,buffer'; " modem tool enable for MPC823FADSDDB
Modem_Audio~ PIN 55 istype 'reg,buffer'; " Modem / Audio functions select
" for modem tool with MPC823 d/b.
*****
"* Board Status Pins. Read only.
*****
"* removed to external buffers

*****
"* Board Status Registers Chip-Selects
*****
Bcsr2Cs~PIN 47 istype 'com';
Bcsr3Cs~PIN 48 istype 'com';
*****
"* Auxiliary Pins.
*****

*****
"* ### *
"* # # # ##### ##### # # ## # # ## #
"* # ## # # # # # # # # # # # # # #
"* # # # # # ##### # # # # # # # # # # #
"* # # # # # # # # # # # # # # # # # # #
"* # # ## # # # # # # # # # # # # # # # #
"* ### # # # ##### # # # # # # # # # # # # #
*****
"* System Hard Reset Configuration.
*****

ERBNODE istype 'reg,buffer'; " External Arbitration
IP~NODE istype 'reg,buffer'; " Interrupt Prefix in MSR
BDISNODE istype 'reg,buffer'; " Boot Disable
RSV2NODE istype 'reg,buffer'; " reserved config bit 2
BPS0,
BPS1NODE istype 'reg,buffer'; " Boot Port Size
RSV6NODE istype 'reg,buffer'; " reserved config bit 6
ISB0,

```

Freescale Semiconductor, Inc.



```

ISB1NODE istype 'reg,buffer';    " Internal Space Base
DBG0,
DBG1NODE istype 'reg,buffer';    " Debug pins Config.
DBPC0,
DBPC1NODE istype 'reg,buffer';    " Debug Port pins Config
RSV13  NODE istype 'reg,buffer';    " reserved config bit 13
RSV14  NODE istype 'reg,buffer';    " reserved config bit 14
RSV15  NODE istype 'reg,buffer';    " reserved config bit 15

```

```

DataOeNODE istype 'com';" data bus output enable on read.

```

```

*****
"* Control Register Enable Protection.
*****

```

```

CntRegEnProtect~NODE istype 'reg,buffer';

```

```

*****
"* Control Register Write (space saving) Mach 10 required for 52Mhz
*****

```

```

Bcsr0Write~ NODE istype 'com';
Bcsr1Write~ NODE istype 'com';
Bcsr4Write~ NODE istype 'com';

```

```

*****
"* #####
"* # # ##### # # ##### ##### ## # # #####
"* # # # # # # # # # # # # # # # # #
"* # # # # # # # # # # # # # # # # #
"* # # # # # # # # # # # # # # # # #
"* # # # # # # # # # # # # # # # # #
"* ##### ##### # # ##### # # # # # # # #
"*

```

Freescale Semiconductor, Inc.





```

"* #####
"* # # ##### # # # # # # # # # # #
"* # # # # # # # # # # # # # # # # #
"* # # ##### # # # # # # # # # # # # # # #
"* # # # # # # # # # # # # # # # # # # # # #
"* # # # # # # # # # # # # # # # # # # # # #
"* ##### # # # # # # # # # # # # # # # # # # # # #
"
"* # # # # # # # # # # # # # # # # # # # # # # # # # # # #
"* # # # # # # # # # # # # # # # # # # # # # # # # # # # #
"* # # # # # # # # # # # # # # # # # # # # # # # # # # # #
"* ##### # # # # # # # # # # # # # # # # # # # # # # # # # # # #
"* # # # # # # # # # # # # # # # # # # # # # # # # # # # #
"* # # # # # # # # # # # # # # # # # # # # # # # # # # # #

```

H, L, X, Z = 1, 0, .X., .Z.;
C, D, U = .C., .D., .U.;

```

"* SIMULATION = 1;
"* SLOW_PLL_LOCK = 1;
"* DRAM_8_BIT_OPERATION = 1;

```

```

"* Signal groups

```

```

Add = [A27,A29];
Data = [D0..D15];

```

```

ConfigReg = [ERB,IP~,RSV2,BDIS,
             BPS0,BPS1,RSV6,ISB0,
             ISB1,DBGC0,DBGC1,DBPC0,
             DBPC1,RSV13,RSV14,RSV15];

```

```

BPS = [BPS0,BPS1];" boot port size
ISB = [ISB0,ISB1];" Initial Internal Space Base
DBGC = [DBGC0,DBGC1];" Debug Pins Configuration
DBPC = [DBPC0,DBPC1];" Debug port location

```

```

ContReg = [FlashEn~,
           DramEn~,EthEn~,InfRedEn~,FlashCfgEn~,
           CntRegEnProtect~,CntRegEn~,RS232En1~,PccEn~,
           PccVcc0,PccVpp0,PccVpp1,HalfWord~,
           RS232En2~,SdramEn~,PccVcc1,EthLoop,

```

Freescale Semiconductor, Inc.

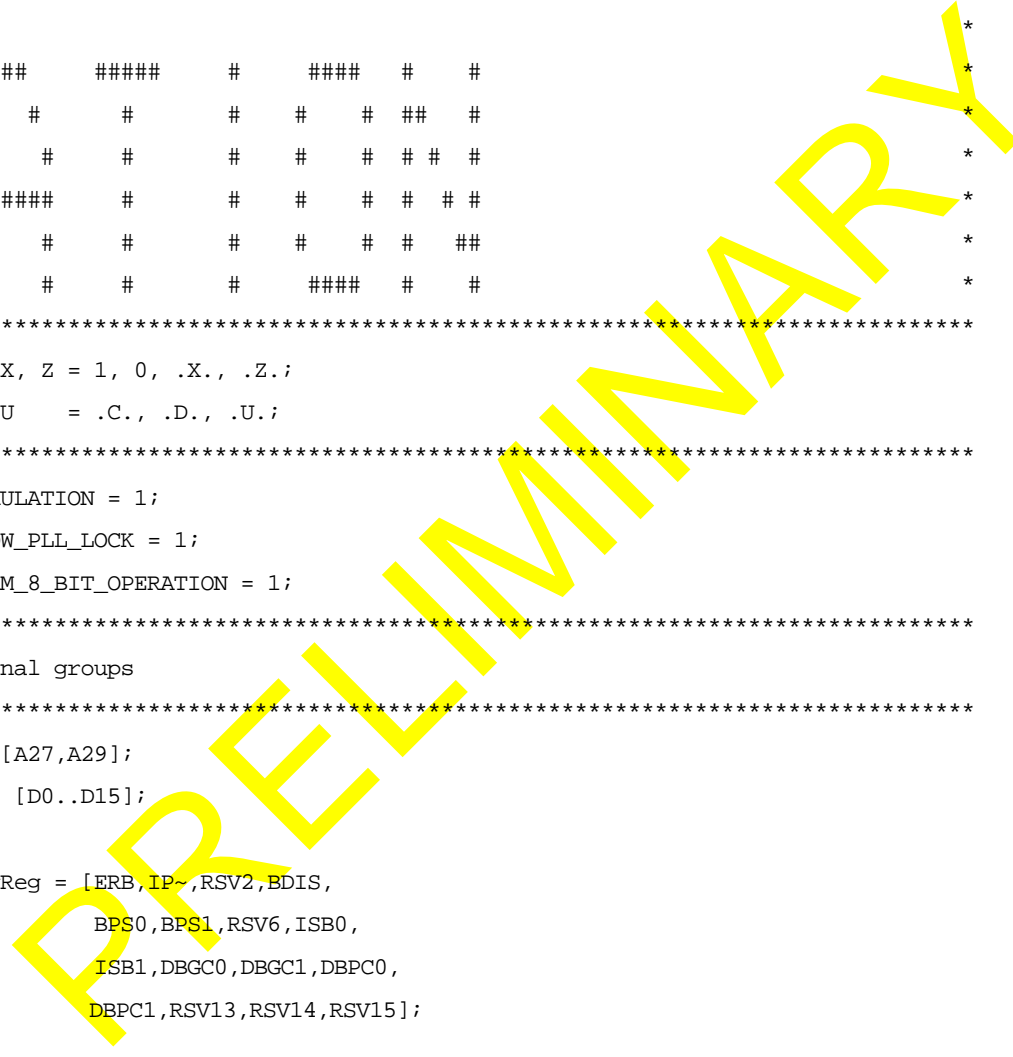

```

TPFLDL~,TPSQEL~,SignalLamp~,UsbUtpFethEn~,
UsbSpeed,UsbVcc0,UsbVcc1,VideoOn~,
VideoExtClkEn,VideoRst~,ModemEn~,Modem_Audio~];

```

```

ReadBcsr1 = [FlashEn~,DramEn~,EthEn~,InfRedEn~,
FlashCfgEn~,CntRegEnProtect~.fb,CntRegEn~,RS232En1~,
PccEn~,PccVcc0,PccVpp0,PccVpp1,
HalfWord~,RS232En2~,SdramEn~,PccVcc1];

```

```

ReadBcsr4 = [EthLoop,
TPFLDL~,TPSQEL~,SignalLamp~,UsbUtpFethEn~,
UsbSpeed,UsbVcc0,UsbVcc1,VideoOn~,
VideoExtClkEn,VideoRst~,ModemEn~,Modem_Audio~];

```

```

DrivenContReg = [FlashEn~,DramEn~,EthEn~,InfRedEn~,
FlashCfgEn~,CntRegEn~,RS232En1~,PccEn~,
PccVcc0,PccVpp0,PccVpp1,HalfWord~,
RS232En2~,SdramEn~,PccVcc1,EthLoop,
TPFLDL~,TPSQEL~,SignalLamp~,UsbUtpFethEn~,
UsbSpeed,UsbVcc0,UsbVcc1,VideoOn~,
VideoExtClkEn,VideoRst~,ModemEn~,Modem_Audio~];

```

```

PccVcc = [PccVcc0,PccVcc1];
PccVpp = [PccVpp0,PccVpp1];

```

```

WideContReg = [FlashEn~,
DramEn~,EthEn~,InfRedEn~,FlashCfgEn~,
CntRegEnProtect~,CntRegEn~,RS232En1~,PccEn~,
PccVcc0,PccVpp0,PccVpp1,HalfWord~,
RS232En2~,SdramEn~,PccVcc1,EthLoop,
TPFLDL~,TPSQEL~,SignalLamp~,UsbUtpFethEn~,
UsbSpeed,UsbVcc0,UsbVcc1,VideoOn~,
VideoExtClkEn,VideoRst~,ModemEn~,Modem_Audio~];

```

```

Bcsr2_3Cs~ = [Bcsr2Cs~,Bcsr3Cs~];

```

```

*****
"* Power On Reset definitions
*****
FLASH_CFG_ENABLE = 0;

```

```

K_A_PON_RESET_ACTIVE = 1;

```



```
RESET_CONFIG_ACTIVE = 0;
```

```
***** changed due to long lock delay of the pda *** 17,7,95 *****
```

```
@ifndef SLOW_PLL_LOCK {
```

```
    KA_PON_RESET = (RGPORIn == K_A_PON_RESET_ACTIVE);
}
```

```
@ifdef SLOW_PLL_LOCK {
```

```
    PON_DEFAULT_ACTIVE = 0;

    KA_PON_RESET = (PonDefault~ == PON_DEFAULT_ACTIVE);
}
```

```
***** end of change *****
```

```
RESET_CONFIG_DRIVEN = ((ResetConf~ == RESET_CONFIG_ACTIVE) &
    (FlashCfgEn~ != FLASH_CFG_ENABLE));
```

```
*****
```

```
"* Register Access definitions
```

```
*****
```

```
CONFIG_REG_ADD = 0;
```

```
CONTROL_REG_1_ADD = 1;
```

```
STATUS_REG2_ADD = 2;
```

```
STATUS_REG3_ADD = 3;
```

```
CONTROL_REG_4_ADD = 4;
```

```
" MPC_WRITE_BCSR_0 = (!BrdContRegCs~ & !TA~ & !R_W~ & !A27 & !A28 & !A29 & !CntRegEn~);
```

```
" MPC_WRITE_BCSR_1 = (!BrdContRegCs~ & !TA~ & !R_W~ & !A27 & !A28 & A29 & !CntRegEn~);
```

```
MPC_WRITE_BCSR_3 = (!BrdContRegCs~ & !TA~ & !R_W~ & !A27 & A28 & A29 & !CntRegEn~);
```

```
"MPC_WRITE_BCSR_4 = (!BrdContRegCs~ & !TA~ & !R_W~ & A27 & !A28 & !A29 & !CntRegEn~);
```

```
BCSR_WRITE_ACTIVE = 0;
```

```
MPC_WRITE_BCSR_0 = (Bcsr0Write~.fb == BCSR_WRITE_ACTIVE);
```

```
MPC_WRITE_BCSR_1 = (Bcsr1Write~.fb == BCSR_WRITE_ACTIVE);
```

```
MPC_WRITE_BCSR_4 = (Bcsr4Write~.fb == BCSR_WRITE_ACTIVE);
```

```

MPC_READ = (!BrdContRegCs~ & R_W~ & !CntRegEn~);

MPC_READ_BCSR_0 = (!BrdContRegCs~ & R_W~ & !A27 & !A28 & !A29 & !CntRegEn~);
MPC_READ_BCSR_1 = (!BrdContRegCs~ & R_W~ & !A27 & !A28 & A29 & !CntRegEn~);
MPC_READ_BCSR_2 = (!BrdContRegCs~ & R_W~ & !A27 & A28 & !A29 & !CntRegEn~);
MPC_READ_BCSR_3 = (!BrdContRegCs~ & R_W~ & !A27 & A28 & A29 & !CntRegEn~);
MPC_READ_BCSR_4 = (!BrdContRegCs~ & R_W~ & A27 & !A28 & !A29 & !CntRegEn~);

*****
*****
"* BCSR 0 definitions
*****
*****

INTERNAL_ARBITRATION = 0;
EXTERNAL_ARBITRATION = !INTERNAL_ARBITRATION;

IP_AT_0xFFF00000 = 0;"active low
IP_AT_0x00000000 = !IP_AT_0xFFF00000;

RSV2_ACTIVE = 1;

BOOT_DISABLE = 1;
BOOT_ENABLE = !BOOT_DISABLE;

BOOT_PORT_32 = 0;
BOOT_PORT_8 = 1;
BOOT_PORT_16 = 2;
BOOT_PORT_RESERVED = 3;

RSV6_ACTIVE = 1;

INT_SPACE_BASE_0x00000000 = 0;
INT_SPACE_BASE_0x00F00000 = 1;
INT_SPACE_BASE_0xFF000000 = 2;
INT_SPACE_BASE_0xFFFF00000 = 3;

DEBUG_PINS_PCMCIA_2 = 0;
DEBUG_PINS_WATCH_POINTS = 1;
DEBUG_PINS_RESREVED = 2;
DEBUG_PINS_FOR_SHOW = 3;

```

Freescale Semiconductor, Inc.



```

DEBUG_PORT_ON_JTAG = 0;
DEBUG_PORT_NON_EXISTANT = 1;
DEBUG_PORT_RESERVED = 2;
DEBUG_PORT_ON_DEBUG_PINS = 3;
RSV13_ACTIVE = 1;
RSV14_ACTIVE = 1;
RSV15_ACTIVE = 1;

```

```

*****
***** Power On Defaults Assignments *****
*****

```

```

ERB_PON_DEFAULT = INTERNAL_ARBITRATION;
IP~_PON_DEFAULT = IP_AT_0x00000000;
RSV2_PON_DEFAULT = !RSV2_ACTIVE;
BDIS_PON_DEFAULT = BOOT_ENABLE;
BPS_PON_DEFAULT = BOOT_PORT_32;
RSV6_PON_DEFAULT = !RSV6_ACTIVE;
ISB_PON_DEFAULT = INT_SPACE_BASE_0xFF000000;
DBGC_PON_DEFAULT = DEBUG_PINS_PCMCIA_2;
DBPC_PON_DEFAULT = DEBUG_PORT_ON_JTAG;
RSV13_PON_DEFAULT = !RSV13_ACTIVE;
RSV14_PON_DEFAULT = !RSV14_ACTIVE;
RSV15_PON_DEFAULT = !RSV15_ACTIVE;

```

```

*****
***** Data Bits Assignments *****
*****

```

```

ERB_DATA_BIT = [D0];
IP~_DATA_BIT = [D1];
RSV2_DATA_BIT = [D2];
BDIS_DATA_BIT = [D3];
BPS_DATA_BIT = [D4,D5];
RSV6_DATA_BIT = [D6];
ISB_DATA_BIT = [D7,D8];
DBGC_DATA_BIT = [D9,D10];
DBPC_DATA_BIT = [D11,D12];
RSV13_DATA_BIT = [D13];
RSV14_DATA_BIT = [D14];
RSV15_DATA_BIT = [D15];

```

```

*****

```

Freescale Semiconductor, Inc.





```

*****
"* BCSR 1 definitions.
*****
*****

HALF_WORD = 0;
ETH_ENABLED = 0;
DRAM_ENABLED = 0;
CONT_REG_ENABLE = 0;
RS232_1_ENABLE = 0;
RS232_2_ENABLE = 0;
PCC_ENABLE = 0;
PCC_VCC_CONT_0 = 0;
PCC_VCC_CONT_1 = 1;
PCC_VPP0 = 1;
PCC_VPP1 = 1;
FLASH_ENABLED = 0;
INF_RED_ENABLE = 0;
"* FLASH_CFG_ENABLE = 0; needed to be defined ealier
DRAM_5V = 0;
DRAM_3V = !DRAM_5V;
CNT_REG_EN_PROTECT = 0; " inadvertant write protect
SDRAM_ENABLED = 1;
*****
***** Power On Defaults Assignments *****
*****
FLASH_ENABLE_PON_DEFAULT = FLASH_ENABLED;
FLASH_CFG_ENABLE_PON_DEFAULT = !FLASH_CFG_ENABLE;
DRAM_ENABLE_PON_DEFAULT = DRAM_ENABLED;
ETH_ENABLE_PON_DEFAULT = !ETH_ENABLED;
CONT_REG_ENABLE_PON_DEFAULT = CONT_REG_ENABLE;
RS232_1_ENABLE_PON_DEFAULT = !RS232_1_ENABLE;
RS232_2_ENABLE_PON_DEFAULT = !RS232_2_ENABLE;
PCC_ENABLE_PON_DEFAULT = !PCC_ENABLE;
PCC_VCC_0_PON_DEFAULT = PCC_VCC_CONT_0;
PCC_VCC_1_PON_DEFAULT = PCC_VCC_CONT_0;
PCC_VPP0_PON_DEFAULT = PCC_VPP0;
PCC_VPP1_PON_DEFAULT = PCC_VPP1; " T.S. as default
INF_RED_ENABLE_PON_DEFAULT = !INF_RED_ENABLE;
HALF_WORD_PON_DEFAULT = !HALF_WORD;
SDRAM_ENABLE_PON_DEFAULT = SDRAM_ENABLED;
CNT_REG_EN_PROTECT_PON_DEFAULT = CNT_REG_EN_PROTECT;
*****

```

Freescale Semiconductor, Inc.

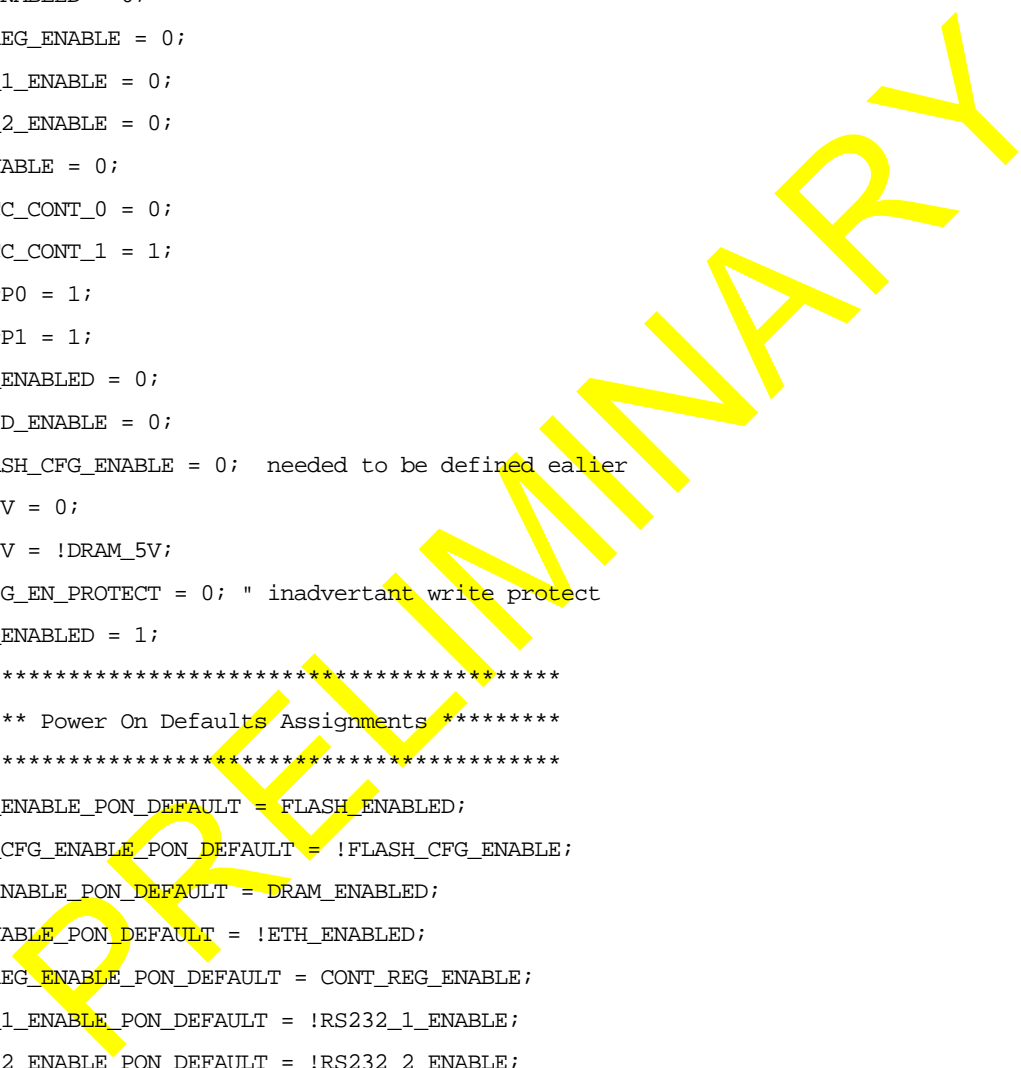

***** Data Bits Assignments *****

```
FLASH_ENABLE_DATA_BIT = [D0];
DRAM_ENABLE_DATA_BIT = [D1];
ETH_ENABLE_DATA_BIT = [D2];
INF_RED_ENABLE_DATA_BIT = [D3];
FLASH_CFG_ENABLE_DATA_BIT = [D4];
CNT_REG_EN_PROTECT_DATA_BIT = [D5];
CONT_REG_ENABLE_DATA_BIT = [D6];
RS232_1_ENABLE_DATA_BIT = [D7];
PCC_ENABLE_DATA_BIT = [D8];
PCC_VCC_0_DATA_BIT = [D9];
PCC_VPP0_DATA_BIT = [D10];
PCC_VPP1_DATA_BIT = [D11];
HALF_WORD_DATA_BIT = [D12];
RS232_2_ENABLE_DATA_BIT = [D13];
SDRAM_ENABLE_DATA_BIT = [D14];
PCC_VCC_1_DATA_BIT = [D15];
```

* BCSR 4 definitions.

```
ETH_LOOP = 1;
ETH_FULLL_DUP = 0;
ETH_CLSN_TEST = 0;
SIGNAL_LAMP_ON = 0;
USB_UTP_FETH_ENABLED = 0;
USB_FULLL_SPEED = 1;
USB_VCC_CONT_0 = 0;
VIDEO_ENABLED = 0;
VIDEO_EXT_CLK_ENABLED = 1;
VIDEO_RESET_ACTIVE = 0;
MODEM_ENABLED_FOR_823 = 0;
MODEM = 1;
```

***** Power On Defaults Assignments *****

```
ETH_LOOP_PON_DEFAULT = !ETH_LOOP;
ETH_FULLL_DUP_PON_DEFAULT = !ETH_FULLL_DUP;
ETH_CLSN_TEST_PON_DEFAULT = !ETH_CLSN_TEST;
```

Freescale Semiconductor, Inc.





```

SIGNAL_LAMP_PON_DEFAULT = !SIGNAL_LAMP_ON;
USB_UTP_FETH_EN_PON_DEFAULT = !USB_UTP_FETH_ENABLED;
USB_SPEED_PON_DEFAULT = USB_FULL_SPEED;
USB_VCC_0_CONT_PON_DEFAULT = !USB_VCC_CONT_0;
USB_VCC_1_CONT_PON_DEFAULT = !USB_VCC_CONT_0;
VIDEO_ENABLE_PON_DEFAULT = !VIDEO_ENABLED;
VIDEO_EXT_CLK_EN_PON_DEFAULT = !VIDEO_EXT_CLK_ENABLED;
VIDEO_RESET_PON_DEFAULT = !VIDEO_RESET_ACTIVE;
MODEM_ENABLE_PON_DEFAULT = !MODEM_ENABLED_FOR_823;
MODEM_FUNC_SEL_PON_DEFAULT = MODEM;
*****
***** Data Bits Assignments *****
*****
ETH_LOOP_DATA_BIT = [D0];
ETH_FULL_DUP_DATA_BIT = [D1];
ETH_CLSN_TEST_DATA_BIT = [D2];
SIGNAL_LAMP_DATA_BIT = [D3];
USB_UTP_FETH_EN_DATA_BIT = [D4];
USB_SPEED_DATA_BIT = [D5];
USB_VCC_0_DATA_BIT = [D6];
USB_VCC_1_DATA_BIT = [D7];
VIDEO_ENABLE_DATA_BIT = [D8];
VIDEO_EXT_CLK_EN_DATA_BIT = [D9];
VIDEO_RESET_DATA_BIT = [D10];
MODEM_ENABLE_DATA_BIT = [D11];
MODEM_FUNC_SEL_DATA_BIT = [D12];
*****
/* Equations, state diagrams.                                     *
*****
/*
/* #####
/* #      ##### # # ## ##### #   ##### # #   ##### *
/* #      # # # # # # # # # # # # # # # # # # # # # # *
/* ##### # # # # # # # # # # # # # # # # # # # # # # # *
/* #      # # # # # ##### # # # # # # # # # # # # # # *
/* #      # # # # # # # # # # # # # # # # # # # # # # # *
/* ##### # # # # # # # # # # # # # # # # # # # # # # # *
/*
*****
/* Configuration Register.
/* Gets its default pon reset values which are driven to the data bus when
/* during hard reset configuration.

```

Freescale Semiconductor, Inc.



"* If other values are required, this register may be written with new values
 "* to become active for the next hard reset.
 "* The state machines are built in a way that its power on value is changed in
 "* one place - the declarations area.
 "*****

equations

```
@ifdef SLOW_PLL_LOCK {
```

```
    !PonDefault~ = !ResetConf~ #
    RGPORIn;
```

```
}
```

```
!Bcsr0Write~ = (!BrdContRegCs~ & !TA~ & !R_W~ & !A27 & !A28 & !A29 & !CntRegEn~);
!Bcsr1Write~ = (!BrdContRegCs~ & !TA~ & !R_W~ & !A27 & !A28 & A29 & !CntRegEn~);
!Bcsr4Write~ = (!BrdContRegCs~ & !TA~ & !R_W~ & A27 & !A28 & !A29 & !CntRegEn~);
```

```
ConfigReg.clk = SYSCLK;
```

```
state_diagram ERB
```

```
state INTERNAL_ARBITRATION:
    if (MPC_WRITE_BCSR_0 &
        (ERB_DATA_BIT.pin == EXTERNAL_ARBITRATION) &
        (!KA_PON_RESET # (ERB_PON_DEFAULT != INTERNAL_ARBITRATION)) #
        (KA_PON_RESET & (ERB_PON_DEFAULT == EXTERNAL_ARBITRATION)) ) then
        EXTERNAL_ARBITRATION
    else
        INTERNAL_ARBITRATION;
state EXTERNAL_ARBITRATION:
    if (MPC_WRITE_BCSR_0 &
        (ERB_DATA_BIT.pin == INTERNAL_ARBITRATION) &
        (!KA_PON_RESET # (ERB_PON_DEFAULT != EXTERNAL_ARBITRATION)) #
        (KA_PON_RESET & (ERB_PON_DEFAULT == INTERNAL_ARBITRATION)) ) then
        INTERNAL_ARBITRATION
    else
        EXTERNAL_ARBITRATION;
```

```
state_diagram IP~
```

```
state IP_AT_0xFFFF0000:
```

Freescale Semiconductor, Inc.



```

    if (MPC_WRITE_BCSR_0 &
        (IP~_DATA_BIT.pin == IP_AT_0x00000000) &
        (!KA_PON_RESET # (IP~_PON_DEFAULT != IP_AT_0xFFFF0000)) #
        (KA_PON_RESET & (IP~_PON_DEFAULT == IP_AT_0x00000000)) ) then
        IP_AT_0x00000000
    else
        IP_AT_0xFFFF0000;
state IP_AT_0x00000000:
    if (MPC_WRITE_BCSR_0 &
        (IP~_DATA_BIT.pin == IP_AT_0xFFFF0000) &
        (!KA_PON_RESET # (IP~_PON_DEFAULT != IP_AT_0x00000000)) #
        (KA_PON_RESET & (IP~_PON_DEFAULT == IP_AT_0xFFFF0000)) ) then
        IP_AT_0xFFFF0000
    else
        IP_AT_0x00000000;
*****
state_diagram RSV2
state !RSV2_ACTIVE:
    if (MPC_WRITE_BCSR_0 &
        (RSV2_DATA_BIT.pin == RSV2_ACTIVE) &
        (!KA_PON_RESET # (RSV2_PON_DEFAULT != !RSV2_ACTIVE)) #
        (KA_PON_RESET & (RSV2_PON_DEFAULT == RSV2_ACTIVE)) ) then
        RSV2_ACTIVE
    else
        !RSV2_ACTIVE;
state RSV2_ACTIVE:
    if (MPC_WRITE_BCSR_0 &
        (RSV2_DATA_BIT.pin == !RSV2_ACTIVE) &
        (!KA_PON_RESET # (RSV2_PON_DEFAULT != RSV2_ACTIVE)) #
        (KA_PON_RESET & (RSV2_PON_DEFAULT == !RSV2_ACTIVE)) ) then
        !RSV2_ACTIVE
    else
        RSV2_ACTIVE;
*****
state_diagram BDIS
state BOOT_ENABLE:
    if (MPC_WRITE_BCSR_0 &
        (BDIS_DATA_BIT.pin == BOOT_DISABLE) &
        (!KA_PON_RESET # (BDIS_PON_DEFAULT != BOOT_ENABLE)) #
        (KA_PON_RESET & (BDIS_PON_DEFAULT == BOOT_DISABLE)) ) then
        BOOT_DISABLE
    else

```

Freescale Semiconductor, Inc.



```

BOOT_ENABLE;
state BOOT_DISABLE:
  if (MPC_WRITE_BCSR_0 &
      (BDIS_DATA_BIT.pin == BOOT_ENABLE) &
      (!KA_PON_RESET # (BDIS_PON_DEFAULT != BOOT_DISABLE)) #
      (KA_PON_RESET & (BDIS_PON_DEFAULT == BOOT_ENABLE)) ) then
    BOOT_ENABLE
  else
    BOOT_DISABLE;
*****
state_diagram BPS
state BOOT_PORT_32:
  if (MPC_WRITE_BCSR_0 &
      (BPS_DATA_BIT.pin == BOOT_PORT_8) &
      (!KA_PON_RESET # (BPS_PON_DEFAULT != BOOT_PORT_32)) #
      (KA_PON_RESET & (BPS_PON_DEFAULT == BOOT_PORT_8)) ) then
    BOOT_PORT_8
  else if (MPC_WRITE_BCSR_0 &
      (BPS_DATA_BIT.pin == BOOT_PORT_16) &
      (!KA_PON_RESET # (BPS_PON_DEFAULT != BOOT_PORT_32)) #
      (KA_PON_RESET & (BPS_PON_DEFAULT == BOOT_PORT_16)) ) then
    BOOT_PORT_16
  else if (MPC_WRITE_BCSR_0 &
      (BPS_DATA_BIT.pin == BOOT_PORT_RESERVED) &
      (!KA_PON_RESET # (BPS_PON_DEFAULT != BOOT_PORT_32)) #
      (KA_PON_RESET & (BPS_PON_DEFAULT == BOOT_PORT_RESERVED)) ) then
    BOOT_PORT_RESERVED
  else
    BOOT_PORT_32;
state BOOT_PORT_8:
  if (MPC_WRITE_BCSR_0 &
      (BPS_DATA_BIT.pin == BOOT_PORT_32) &
      (!KA_PON_RESET # (BPS_PON_DEFAULT != BOOT_PORT_8)) #
      (KA_PON_RESET & (BPS_PON_DEFAULT == BOOT_PORT_32)) ) then
    BOOT_PORT_32
  else if (MPC_WRITE_BCSR_0 &
      (BPS_DATA_BIT.pin == BOOT_PORT_16) &
      (!KA_PON_RESET # (BPS_PON_DEFAULT != BOOT_PORT_8)) #
      (KA_PON_RESET & (BPS_PON_DEFAULT == BOOT_PORT_16)) ) then
    BOOT_PORT_16
  else if (MPC_WRITE_BCSR_0 &
      (BPS_DATA_BIT.pin == BOOT_PORT_RESERVED) &

```

Freescale Semiconductor, Inc.



```

        (!KA_PON_RESET # (BPS_PON_DEFAULT != BOOT_PORT_8)) #
        (KA_PON_RESET & (BPS_PON_DEFAULT == BOOT_PORT_RESERVED)) ) then
    BOOT_PORT_RESERVED
else
    BOOT_PORT_8;
state BOOT_PORT_16:
    if (MPC_WRITE_BCSR_0 &
        (BPS_DATA_BIT.pin == BOOT_PORT_32) &
        (!KA_PON_RESET # (BPS_PON_DEFAULT != BOOT_PORT_16)) #
        (KA_PON_RESET & (BPS_PON_DEFAULT == BOOT_PORT_32)) ) then
        BOOT_PORT_32
    else if (MPC_WRITE_BCSR_0 &
        (BPS_DATA_BIT.pin == BOOT_PORT_8) &
        (!KA_PON_RESET # (BPS_PON_DEFAULT != BOOT_PORT_16)) #
        (KA_PON_RESET & (BPS_PON_DEFAULT == BOOT_PORT_8)) ) then
        BOOT_PORT_8
    else if (MPC_WRITE_BCSR_0 &
        (BPS_DATA_BIT.pin == BOOT_PORT_RESERVED) &
        (!KA_PON_RESET # (BPS_PON_DEFAULT != BOOT_PORT_16)) #
        (KA_PON_RESET & (BPS_PON_DEFAULT == BOOT_PORT_RESERVED)) ) then
        BOOT_PORT_RESERVED
    else
        BOOT_PORT_16;
state BOOT_PORT_RESERVED:
    if (MPC_WRITE_BCSR_0 &
        (BPS_DATA_BIT.pin == BOOT_PORT_32) &
        (!KA_PON_RESET # (BPS_PON_DEFAULT != BOOT_PORT_RESERVED)) #
        (KA_PON_RESET & (BPS_PON_DEFAULT == BOOT_PORT_32)) ) then
        BOOT_PORT_32
    else if (MPC_WRITE_BCSR_0 &
        (BPS_DATA_BIT.pin == BOOT_PORT_16) &
        (!KA_PON_RESET # (BPS_PON_DEFAULT != BOOT_PORT_RESERVED)) #
        (KA_PON_RESET & (BPS_PON_DEFAULT == BOOT_PORT_16)) ) then
        BOOT_PORT_16
    else if (MPC_WRITE_BCSR_0 &
        (BPS_DATA_BIT.pin == BOOT_PORT_8) &
        (!KA_PON_RESET # (BPS_PON_DEFAULT != BOOT_PORT_RESERVED)) #
        (KA_PON_RESET & (BPS_PON_DEFAULT == BOOT_PORT_8)) ) then
        BOOT_PORT_8
    else
        BOOT_PORT_RESERVED;

```

```

state_diagram RSV6
state !RSV6_ACTIVE:
    if (MPC_WRITE_BCSR_0 &
        (RSV6_DATA_BIT.pin == RSV6_ACTIVE) &
        (!KA_PON_RESET # (RSV6_PON_DEFAULT != !RSV6_ACTIVE)) #
        (KA_PON_RESET & (RSV6_PON_DEFAULT == RSV6_ACTIVE)) ) then
        RSV6_ACTIVE
    else
        !RSV6_ACTIVE;
state RSV2_ACTIVE:
    if (MPC_WRITE_BCSR_0 &
        (RSV6_DATA_BIT.pin == !RSV6_ACTIVE) &
        (!KA_PON_RESET # (RSV6_PON_DEFAULT != RSV6_ACTIVE)) #
        (KA_PON_RESET & (RSV6_PON_DEFAULT == !RSV6_ACTIVE)) ) then
        !RSV6_ACTIVE
    else
        RSV6_ACTIVE;
*****
state_diagram ISB
state INT_SPACE_BASE_0x00000000:
    if (MPC_WRITE_BCSR_0 &
        (ISB_DATA_BIT.pin == INT_SPACE_BASE_0x00F00000) &
        (!KA_PON_RESET # (ISB_PON_DEFAULT != INT_SPACE_BASE_0x00000000)) #
        (KA_PON_RESET & (ISB_PON_DEFAULT == INT_SPACE_BASE_0x00F00000)) ) then
        INT_SPACE_BASE_0x00F00000
    else if (MPC_WRITE_BCSR_0 &
        (ISB_DATA_BIT.pin == INT_SPACE_BASE_0xFF000000) &
        (!KA_PON_RESET # (ISB_PON_DEFAULT != INT_SPACE_BASE_0x00000000)) #
        (KA_PON_RESET & (ISB_PON_DEFAULT == INT_SPACE_BASE_0xFF000000)) ) then
        INT_SPACE_BASE_0xFF000000
    else if (MPC_WRITE_BCSR_0 &
        (ISB_DATA_BIT.pin == INT_SPACE_BASE_0xFFF00000) &
        (!KA_PON_RESET # (ISB_PON_DEFAULT != INT_SPACE_BASE_0x00000000)) #
        (KA_PON_RESET & (ISB_PON_DEFAULT == INT_SPACE_BASE_0xFFF00000)) ) then
        INT_SPACE_BASE_0xFFF00000
    else
        INT_SPACE_BASE_0x00000000;

state INT_SPACE_BASE_0x00F00000:
    if (MPC_WRITE_BCSR_0 &
        (ISB_DATA_BIT.pin == INT_SPACE_BASE_0x00000000) &
        (!KA_PON_RESET # (ISB_PON_DEFAULT != INT_SPACE_BASE_0x00F00000)) #

```

Freescale Semiconductor, Inc.

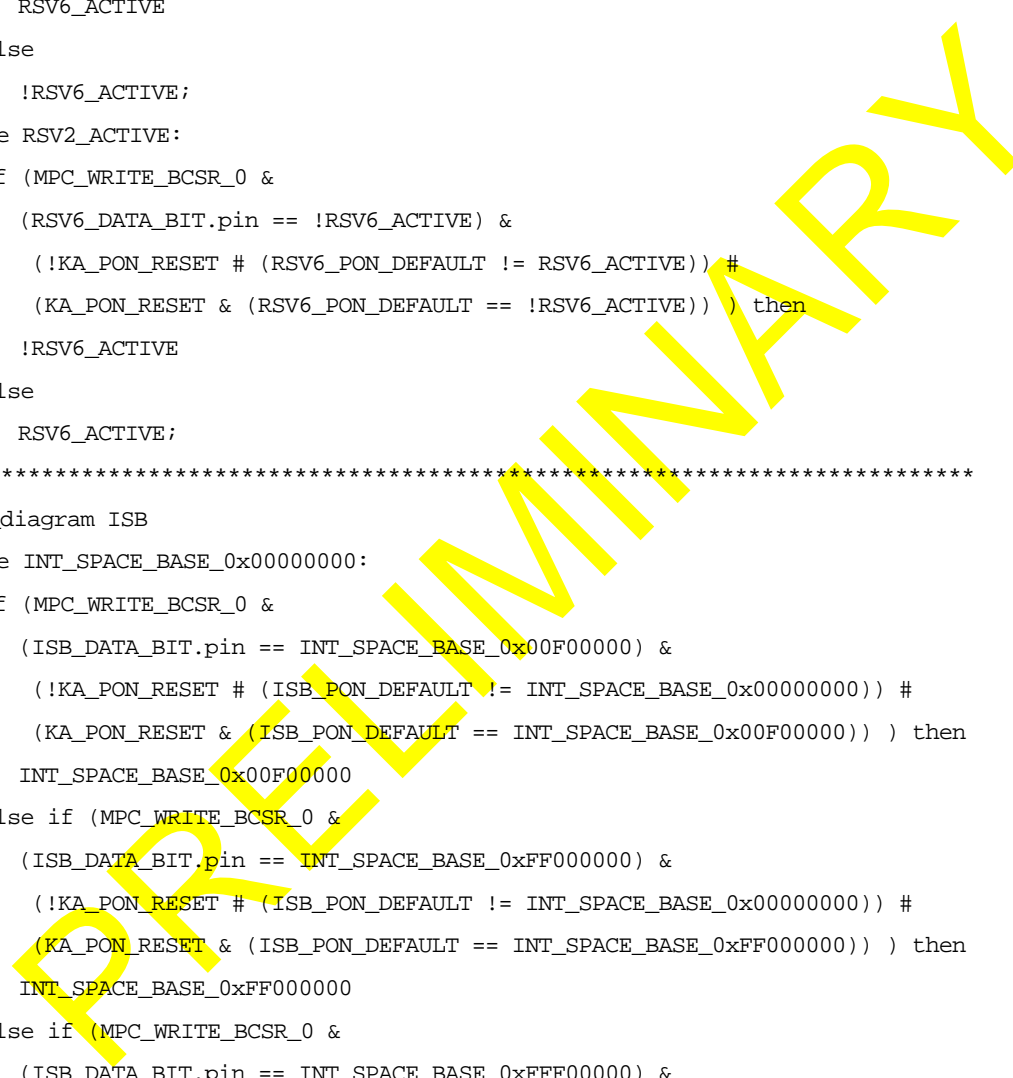



```
(KA_PON_RESET & (ISB_PON_DEFAULT == INT_SPACE_BASE_0x00000000)) ) then
INT_SPACE_BASE_0x00000000
else if (MPC_WRITE_BCSR_0 &
(ISB_DATA_BIT.pin == INT_SPACE_BASE_0xFF000000) &
(!KA_PON_RESET # (ISB_PON_DEFAULT != INT_SPACE_BASE_0x00F00000)) #
(KA_PON_RESET & (ISB_PON_DEFAULT == INT_SPACE_BASE_0xFF000000)) ) then
INT_SPACE_BASE_0xFF000000
else if (MPC_WRITE_BCSR_0 &
(ISB_DATA_BIT.pin == INT_SPACE_BASE_0xFFFF0000) &
(!KA_PON_RESET # (ISB_PON_DEFAULT != INT_SPACE_BASE_0x00F00000)) #
(KA_PON_RESET & (ISB_PON_DEFAULT == INT_SPACE_BASE_0xFFFF0000)) ) then
INT_SPACE_BASE_0xFFFF0000
else
INT_SPACE_BASE_0x00F00000;

state INT_SPACE_BASE_0xFF000000:
if (MPC_WRITE_BCSR_0 &
(ISB_DATA_BIT.pin == INT_SPACE_BASE_0x00000000) &
(!KA_PON_RESET # (ISB_PON_DEFAULT != INT_SPACE_BASE_0xFF000000)) #
(KA_PON_RESET & (ISB_PON_DEFAULT == INT_SPACE_BASE_0x00000000)) ) then
INT_SPACE_BASE_0x00000000
else if (MPC_WRITE_BCSR_0 &
(ISB_DATA_BIT.pin == INT_SPACE_BASE_0x00F00000) &
(!KA_PON_RESET # (ISB_PON_DEFAULT != INT_SPACE_BASE_0xFF000000)) #
(KA_PON_RESET & (ISB_PON_DEFAULT == INT_SPACE_BASE_0x00F00000)) ) then
INT_SPACE_BASE_0x00F00000
else if (MPC_WRITE_BCSR_0 &
(ISB_DATA_BIT.pin == INT_SPACE_BASE_0xFFFF0000) &
(!KA_PON_RESET # (ISB_PON_DEFAULT != INT_SPACE_BASE_0xFF000000)) #
(KA_PON_RESET & (ISB_PON_DEFAULT == INT_SPACE_BASE_0xFFFF0000)) ) then
INT_SPACE_BASE_0xFFFF0000
else
INT_SPACE_BASE_0xFF000000;

state INT_SPACE_BASE_0xFFFF0000:
if (MPC_WRITE_BCSR_0 &
(ISB_DATA_BIT.pin == INT_SPACE_BASE_0x00000000) &
(!KA_PON_RESET # (ISB_PON_DEFAULT != INT_SPACE_BASE_0xFFFF0000)) #
(KA_PON_RESET & (ISB_PON_DEFAULT == INT_SPACE_BASE_0x00000000)) ) then
INT_SPACE_BASE_0x00000000
else if (MPC_WRITE_BCSR_0 &
(ISB_DATA_BIT.pin == INT_SPACE_BASE_0x00F00000) &
```

```

(!KA_PON_RESET # (ISB_PON_DEFAULT != INT_SPACE_BASE_0xFFFF0000)) #
(KA_PON_RESET & (ISB_PON_DEFAULT == INT_SPACE_BASE_0x00F00000)) ) then
INT_SPACE_BASE_0x00F00000
else if (MPC_WRITE_BCSR_0 &
(ISB_DATA_BIT.pin == INT_SPACE_BASE_0xFF000000) &
(!KA_PON_RESET # (ISB_PON_DEFAULT != INT_SPACE_BASE_0xFFFF0000)) #
(KA_PON_RESET & (ISB_PON_DEFAULT == INT_SPACE_BASE_0xFF000000)) ) then
INT_SPACE_BASE_0xFF000000
else
INT_SPACE_BASE_0xFFFF0000;
*****
state_diagram DBG_C
state DEBUG_PINS_PCMCIA_2:
if (MPC_WRITE_BCSR_0 &
(DBGC_DATA_BIT.pin == DEBUG_PINS_WATCH_POINTS) &
(!KA_PON_RESET # (DBG_C_PON_DEFAULT != DEBUG_PINS_PCMCIA_2)) #
(KA_PON_RESET & (DBG_C_PON_DEFAULT == DEBUG_PINS_WATCH_POINTS)) ) then
DEBUG_PINS_WATCH_POINTS
else if (MPC_WRITE_BCSR_0 &
(DBGC_DATA_BIT.pin == DEBUG_PINS_RESREVED) &
(!KA_PON_RESET # (DBG_C_PON_DEFAULT != DEBUG_PINS_PCMCIA_2)) #
(KA_PON_RESET & (DBG_C_PON_DEFAULT == DEBUG_PINS_RESREVED)) ) then
DEBUG_PINS_RESREVED
else if (MPC_WRITE_BCSR_0 &
(DBGC_DATA_BIT.pin == DEBUG_PINS_FOR_SHOW) &
(!KA_PON_RESET # (DBG_C_PON_DEFAULT != DEBUG_PINS_PCMCIA_2)) #
(KA_PON_RESET & (DBG_C_PON_DEFAULT == DEBUG_PINS_FOR_SHOW)) ) then
DEBUG_PINS_FOR_SHOW
else
DEBUG_PINS_PCMCIA_2;

state DEBUG_PINS_WATCH_POINTS:
if (MPC_WRITE_BCSR_0 &
(DBGC_DATA_BIT.pin == DEBUG_PINS_PCMCIA_2) &
(!KA_PON_RESET # (DBG_C_PON_DEFAULT != DEBUG_PINS_WATCH_POINTS)) #
(KA_PON_RESET & (DBG_C_PON_DEFAULT == DEBUG_PINS_PCMCIA_2)) ) then
DEBUG_PINS_PCMCIA_2
else if (MPC_WRITE_BCSR_0 &
(DBGC_DATA_BIT.pin == DEBUG_PINS_RESREVED) &
(!KA_PON_RESET # (DBG_C_PON_DEFAULT != DEBUG_PINS_WATCH_POINTS)) #
(KA_PON_RESET & (DBG_C_PON_DEFAULT == DEBUG_PINS_RESREVED)) ) then
DEBUG_PINS_RESREVED

```

Freescale Semiconductor, Inc.

```

else if (MPC_WRITE_BCSR_0 &
        (DBGC_DATA_BIT.pin == DEBUG_PINS_FOR_SHOW) &
        (!KA_PON_RESET # (DBGC_PON_DEFAULT != DEBUG_PINS_WATCH_POINTS)) #
        (KA_PON_RESET & (DBGC_PON_DEFAULT == DEBUG_PINS_FOR_SHOW)) ) then
    DEBUG_PINS_FOR_SHOW
else
    DEBUG_PINS_WATCH_POINTS;

state DEBUG_PINS_RESREVED:
    if (MPC_WRITE_BCSR_0 &
        (DBGC_DATA_BIT.pin == DEBUG_PINS_PCMCIA_2) &
        (!KA_PON_RESET # (DBGC_PON_DEFAULT != DEBUG_PINS_RESREVED)) #
        (KA_PON_RESET & (DBGC_PON_DEFAULT == DEBUG_PINS_PCMCIA_2)) ) then
        DEBUG_PINS_PCMCIA_2
    else if (MPC_WRITE_BCSR_0 &
        (DBGC_DATA_BIT.pin == DEBUG_PINS_WATCH_POINTS) &
        (!KA_PON_RESET # (DBGC_PON_DEFAULT != DEBUG_PINS_RESREVED)) #
        (KA_PON_RESET & (DBGC_PON_DEFAULT == DEBUG_PINS_WATCH_POINTS)) ) then
        DEBUG_PINS_WATCH_POINTS
    else if (MPC_WRITE_BCSR_0 &
        (DBGC_DATA_BIT.pin == DEBUG_PINS_FOR_SHOW) &
        (!KA_PON_RESET # (DBGC_PON_DEFAULT != DEBUG_PINS_RESREVED)) #
        (KA_PON_RESET & (DBGC_PON_DEFAULT == DEBUG_PINS_FOR_SHOW)) ) then
        DEBUG_PINS_FOR_SHOW
    else
        DEBUG_PINS_RESREVED;
state DEBUG_PINS_FOR_SHOW:
    if (MPC_WRITE_BCSR_0 &
        (DBGC_DATA_BIT.pin == DEBUG_PINS_PCMCIA_2) &
        (!KA_PON_RESET # (DBGC_PON_DEFAULT != DEBUG_PINS_FOR_SHOW)) #
        (KA_PON_RESET & (DBGC_PON_DEFAULT == DEBUG_PINS_PCMCIA_2)) ) then
        DEBUG_PINS_PCMCIA_2
    else if (MPC_WRITE_BCSR_0 &
        (DBGC_DATA_BIT.pin == DEBUG_PINS_WATCH_POINTS) &
        (!KA_PON_RESET # (DBGC_PON_DEFAULT != DEBUG_PINS_FOR_SHOW)) #
        (KA_PON_RESET & (DBGC_PON_DEFAULT == DEBUG_PINS_WATCH_POINTS)) ) then
        DEBUG_PINS_WATCH_POINTS
    else if (MPC_WRITE_BCSR_0 &
        (DBGC_DATA_BIT.pin == DEBUG_PINS_RESREVED) &
        (!KA_PON_RESET # (DBGC_PON_DEFAULT != DEBUG_PINS_FOR_SHOW)) #
        (KA_PON_RESET & (DBGC_PON_DEFAULT == DEBUG_PINS_RESREVED)) ) then
        DEBUG_PINS_RESREVED

```

Freescale Semiconductor, Inc.



```

else
    DEBUG_PINS_FOR_SHOW;
*****
state_diagram DBPC
state DEBUG_PORT_ON_JTAG:
    if (MPC_WRITE_BCSR_0 &
        (DBPC_DATA_BIT.pin == DEBUG_PORT_NON_EXISTANT) &
        (!KA_PON_RESET # (DBPC_PON_DEFAULT != DEBUG_PORT_ON_JTAG)) #
        (KA_PON_RESET & (DBPC_PON_DEFAULT == DEBUG_PORT_NON_EXISTANT))) then
        DEBUG_PORT_NON_EXISTANT
    else if (MPC_WRITE_BCSR_0 &
        (DBPC_DATA_BIT.pin == DEBUG_PORT_RESERVED) &
        (!KA_PON_RESET # (DBPC_PON_DEFAULT != DEBUG_PORT_ON_JTAG)) #
        (KA_PON_RESET & (DBPC_PON_DEFAULT == DEBUG_PORT_RESERVED))) then
        DEBUG_PORT_RESERVED
    else if (MPC_WRITE_BCSR_0 &
        (DBPC_DATA_BIT.pin == DEBUG_PORT_ON_DEBUG_PINS) &
        (!KA_PON_RESET # (DBPC_PON_DEFAULT != DEBUG_PORT_ON_JTAG)) #
        (KA_PON_RESET & (DBPC_PON_DEFAULT == DEBUG_PORT_ON_DEBUG_PINS))) then
        DEBUG_PORT_ON_DEBUG_PINS
    else
        DEBUG_PORT_ON_JTAG;

state DEBUG_PORT_NON_EXISTANT:
    if (MPC_WRITE_BCSR_0 &
        (DBPC_DATA_BIT.pin == DEBUG_PORT_ON_JTAG) &
        (!KA_PON_RESET # (DBPC_PON_DEFAULT != DEBUG_PORT_NON_EXISTANT)) #
        (KA_PON_RESET & (DBPC_PON_DEFAULT == DEBUG_PORT_ON_JTAG))) then
        DEBUG_PORT_ON_JTAG
    else if (MPC_WRITE_BCSR_0 &
        (DBPC_DATA_BIT.pin == DEBUG_PORT_RESERVED) &
        (!KA_PON_RESET # (DBPC_PON_DEFAULT != DEBUG_PORT_NON_EXISTANT)) #
        (KA_PON_RESET & (DBPC_PON_DEFAULT == DEBUG_PORT_RESERVED))) then
        DEBUG_PORT_RESERVED
    else if (MPC_WRITE_BCSR_0 &
        (DBPC_DATA_BIT.pin == DEBUG_PORT_ON_DEBUG_PINS) &
        (!KA_PON_RESET # (DBPC_PON_DEFAULT != DEBUG_PORT_NON_EXISTANT)) #
        (KA_PON_RESET & (DBPC_PON_DEFAULT == DEBUG_PORT_ON_DEBUG_PINS))) then
        DEBUG_PORT_ON_DEBUG_PINS
    else
        DEBUG_PORT_NON_EXISTANT;

```

```

state DEBUG_PORT_RESERVED:
  if (MPC_WRITE_BCSR_0 &
      (DBPC_DATA_BIT.pin == DEBUG_PORT_ON_JTAG) &
      (!KA_PON_RESET # (DBPC_PON_DEFAULT != DEBUG_PORT_RESERVED)) #
      (KA_PON_RESET & (DBPC_PON_DEFAULT == DEBUG_PORT_ON_JTAG)) ) then
    DEBUG_PORT_ON_JTAG
  else if (MPC_WRITE_BCSR_0 &
      (DBPC_DATA_BIT.pin == DEBUG_PORT_NON_EXISTANT) &
      (!KA_PON_RESET # (DBPC_PON_DEFAULT != DEBUG_PORT_RESERVED)) #
      (KA_PON_RESET & (DBPC_PON_DEFAULT == DEBUG_PORT_NON_EXISTANT)) ) then
    DEBUG_PORT_NON_EXISTANT
  else if (MPC_WRITE_BCSR_0 &
      (DBPC_DATA_BIT.pin == DEBUG_PORT_ON_DEBUG_PINS) &
      (!KA_PON_RESET # (DBPC_PON_DEFAULT != DEBUG_PORT_RESERVED)) #
      (KA_PON_RESET & (DBPC_PON_DEFAULT == DEBUG_PORT_ON_DEBUG_PINS)) ) then
    DEBUG_PORT_ON_DEBUG_PINS
  else
    DEBUG_PORT_RESERVED;

```

```

state DEBUG_PORT_ON_DEBUG_PINS:
  if (MPC_WRITE_BCSR_0 &
      (DBPC_DATA_BIT.pin == DEBUG_PORT_ON_JTAG) &
      (!KA_PON_RESET # (DBPC_PON_DEFAULT != DEBUG_PORT_ON_DEBUG_PINS)) #
      (KA_PON_RESET & (DBPC_PON_DEFAULT == DEBUG_PORT_ON_JTAG)) ) then
    DEBUG_PORT_ON_JTAG
  else if (MPC_WRITE_BCSR_0 &
      (DBPC_DATA_BIT.pin == DEBUG_PORT_NON_EXISTANT) &
      (!KA_PON_RESET # (DBPC_PON_DEFAULT != DEBUG_PORT_ON_DEBUG_PINS)) #
      (KA_PON_RESET & (DBPC_PON_DEFAULT == DEBUG_PORT_NON_EXISTANT)) ) then
    DEBUG_PORT_NON_EXISTANT
  else if (MPC_WRITE_BCSR_0 &
      (DBPC_DATA_BIT.pin == DEBUG_PORT_RESERVED) &
      (!KA_PON_RESET # (DBPC_PON_DEFAULT != DEBUG_PORT_ON_DEBUG_PINS)) #
      (KA_PON_RESET & (DBPC_PON_DEFAULT == DEBUG_PORT_RESERVED)) ) then
    DEBUG_PORT_RESERVED
  else
    DEBUG_PORT_ON_DEBUG_PINS;

```

```

state_diagram RSV13
  state !RSV13_ACTIVE:
    if (MPC_WRITE_BCSR_0 &

```

```

(RSV13_DATA_BIT.pin == RSV13_ACTIVE) &
(!KA_PON_RESET # (RSV13_PON_DEFAULT != !RSV13_ACTIVE)) #
(KA_PON_RESET & (RSV13_PON_DEFAULT == RSV13_ACTIVE)) ) then
RSV13_ACTIVE
else
!RSV13_ACTIVE;
state RSV13_ACTIVE:
if (MPC_WRITE_BCSR_0 &
(RSV13_DATA_BIT.pin == !RSV13_ACTIVE) &
(!KA_PON_RESET # (RSV13_PON_DEFAULT != RSV13_ACTIVE)) #
(KA_PON_RESET & (RSV13_PON_DEFAULT == !RSV13_ACTIVE)) ) then
!RSV13_ACTIVE
else
RSV13_ACTIVE;
*****
state_diagram RSV14
state !RSV14_ACTIVE:
if (MPC_WRITE_BCSR_0 &
(RSV14_DATA_BIT.pin == RSV14_ACTIVE) &
(!KA_PON_RESET # (RSV14_PON_DEFAULT != !RSV14_ACTIVE)) #
(KA_PON_RESET & (RSV14_PON_DEFAULT == RSV14_ACTIVE)) ) then
RSV14_ACTIVE
else
!RSV14_ACTIVE;
state RSV14_ACTIVE:
if (MPC_WRITE_BCSR_0 &
(RSV14_DATA_BIT.pin == !RSV14_ACTIVE) &
(!KA_PON_RESET # (RSV14_PON_DEFAULT != RSV14_ACTIVE)) #
(KA_PON_RESET & (RSV14_PON_DEFAULT == !RSV14_ACTIVE)) ) then
!RSV14_ACTIVE
else
RSV14_ACTIVE;
*****
state_diagram RSV15
state !RSV15_ACTIVE:
if (MPC_WRITE_BCSR_0 &
(RSV15_DATA_BIT.pin == RSV15_ACTIVE) &
(!KA_PON_RESET # (RSV15_PON_DEFAULT != !RSV15_ACTIVE)) #
(KA_PON_RESET & (RSV15_PON_DEFAULT == RSV15_ACTIVE)) ) then
RSV15_ACTIVE
else
!RSV15_ACTIVE;

```

Freescale Semiconductor, Inc.

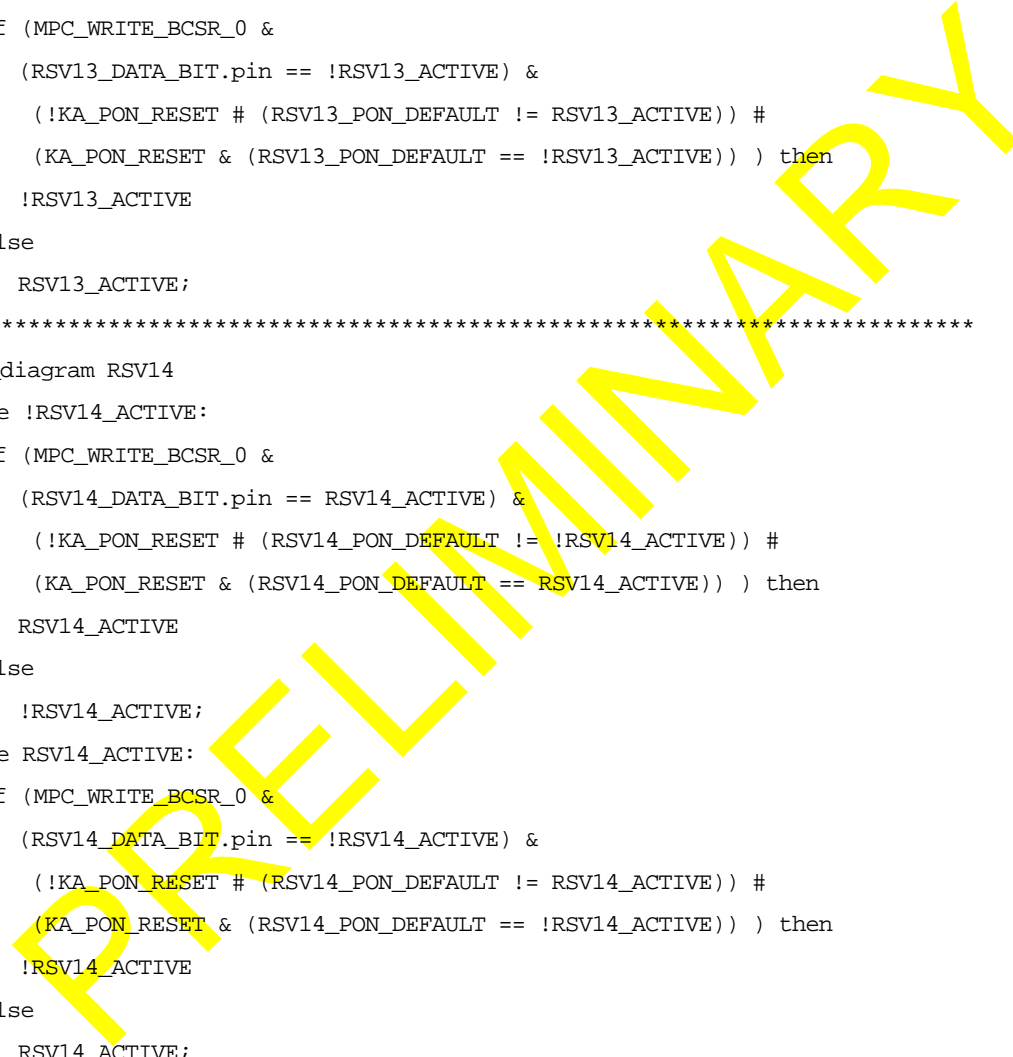

```

state RSV15_ACTIVE:
    if (MPC_WRITE_BCSR_0 &
        (RSV15_DATA_BIT.pin == !RSV15_ACTIVE) &
        (!KA_PON_RESET # (RSV15_PON_DEFAULT != RSV15_ACTIVE)) #
        (KA_PON_RESET & (RSV15_PON_DEFAULT == !RSV15_ACTIVE)) ) then
        !RSV15_ACTIVE
    else
        RSV15_ACTIVE;
*****
*****
"* BCSR 1
*****
*****
equations

WideContReg.clk = SYSCLK;
DrivenContReg.oe = ^hfffffff;

state_diagram FlashEn~
state FLASH_ENABLED:
    if (MPC_WRITE_BCSR_1 &
        (FLASH_ENABLE_DATA_BIT.pin == !FLASH_ENABLED) &
        (!KA_PON_RESET # (FLASH_ENABLE_PON_DEFAULT != FLASH_ENABLED)) #
        (KA_PON_RESET & (FLASH_ENABLE_PON_DEFAULT == !FLASH_ENABLED)) ) then
        !FLASH_ENABLED
    else
        FLASH_ENABLED;
state !FLASH_ENABLED:
    if (MPC_WRITE_BCSR_1 &
        (FLASH_ENABLE_DATA_BIT.pin == FLASH_ENABLED) &
        (!KA_PON_RESET # (FLASH_ENABLE_PON_DEFAULT != !FLASH_ENABLED)) #
        (KA_PON_RESET & (FLASH_ENABLE_PON_DEFAULT == FLASH_ENABLED)) ) then
        FLASH_ENABLED
    else
        !FLASH_ENABLED;
*****

state_diagram DramEn~
state DRAM_ENABLED:
    if (MPC_WRITE_BCSR_1 &
        (DRAM_ENABLE_DATA_BIT.pin == !DRAM_ENABLED) &
        (!KA_PON_RESET # (DRAM_ENABLE_PON_DEFAULT != DRAM_ENABLED)) #
        (KA_PON_RESET & (DRAM_ENABLE_PON_DEFAULT == !DRAM_ENABLED)) ) then

```

Freescale Semiconductor, Inc.



```

!DRAM_ENABLED
else
    DRAM_ENABLED;
state !DRAM_ENABLED:
    if (MPC_WRITE_BCSR_1 &
        (DRAM_ENABLE_DATA_BIT.pin == DRAM_ENABLED) &
        (!KA_PON_RESET # (DRAM_ENABLE_PON_DEFAULT != !DRAM_ENABLED)) #
        (KA_PON_RESET & (DRAM_ENABLE_PON_DEFAULT == DRAM_ENABLED)) ) then
        DRAM_ENABLED
    else
        !DRAM_ENABLED;

*****
state_diagram EthEn~
state ETH_ENABLED:
    if (MPC_WRITE_BCSR_1 &
        (ETH_ENABLE_DATA_BIT.pin == !ETH_ENABLED) &
        (!KA_PON_RESET # (ETH_ENABLE_PON_DEFAULT != ETH_ENABLED)) #
        (KA_PON_RESET & (ETH_ENABLE_PON_DEFAULT == !ETH_ENABLED)) ) then
        !ETH_ENABLED
    else
        ETH_ENABLED;
state !ETH_ENABLED:
    if (MPC_WRITE_BCSR_1 &
        (ETH_ENABLE_DATA_BIT.pin == ETH_ENABLED) &
        (!KA_PON_RESET # (ETH_ENABLE_PON_DEFAULT != !ETH_ENABLED)) #
        (KA_PON_RESET & (ETH_ENABLE_PON_DEFAULT == ETH_ENABLED)) ) then
        ETH_ENABLED
    else
        !ETH_ENABLED;

*****
state_diagram InfRedEn~
state INF_RED_ENABLE:
    if (MPC_WRITE_BCSR_1 &
        (INF_RED_ENABLE_DATA_BIT.pin == !INF_RED_ENABLE) &
        (!KA_PON_RESET # (INF_RED_ENABLE_PON_DEFAULT != INF_RED_ENABLE)) #
        (KA_PON_RESET & (INF_RED_ENABLE_PON_DEFAULT == !INF_RED_ENABLE)) ) then
        !INF_RED_ENABLE
    else
        INF_RED_ENABLE;
state !INF_RED_ENABLE:
    if (MPC_WRITE_BCSR_1 &

```

Freescale Semiconductor, Inc.



```

(INF_RED_ENABLE_DATA_BIT.pin == INF_RED_ENABLE) &
(!KA_PON_RESET # (INF_RED_ENABLE_PON_DEFAULT != !INF_RED_ENABLE)) #
(KA_PON_RESET & (INF_RED_ENABLE_PON_DEFAULT == INF_RED_ENABLE)) ) then
INF_RED_ENABLE
else
!INF_RED_ENABLE;
*****
state_diagram FlashCfgEn~
state FLASH_CFG_ENABLE:
if (MPC_WRITE_BCSR_1 &
(FLASH_CFG_ENABLE_DATA_BIT.pin == !FLASH_CFG_ENABLE) &
(!KA_PON_RESET # (FLASH_CFG_ENABLE_PON_DEFAULT != FLASH_CFG_ENABLE)) #
(KA_PON_RESET & (FLASH_CFG_ENABLE_PON_DEFAULT == !FLASH_CFG_ENABLE)) ) then
!FLASH_CFG_ENABLE
else
FLASH_CFG_ENABLE;
state !FLASH_CFG_ENABLE:
if (MPC_WRITE_BCSR_1 &
(FLASH_CFG_ENABLE_DATA_BIT.pin == FLASH_CFG_ENABLE) &
(!KA_PON_RESET # (FLASH_CFG_ENABLE_PON_DEFAULT != !FLASH_CFG_ENABLE)) #
(KA_PON_RESET & (FLASH_CFG_ENABLE_PON_DEFAULT == FLASH_CFG_ENABLE)) ) then
FLASH_CFG_ENABLE
else
!FLASH_CFG_ENABLE;
*****
"* To avoid in advertant write to the Control Register Enable bit, which might
"* result in a need to re-power the board - protection logic is provided.
"* In order of writing the Control Register Enable this bit in the status register
"* must be negated. After any write to the control register, this bit asserts
"* again (to protected mode)
*****
equations

CntRegEnProtect~.clk = SYSCLK;

state_diagram CntRegEnProtect~
state CNT_REG_EN_PROTECT:
if (MPC_WRITE_BCSR_3 &
(CNT_REG_EN_PROTECT_DATA_BIT.pin == !CNT_REG_EN_PROTECT) &
(!KA_PON_RESET # (CNT_REG_EN_PROTECT_PON_DEFAULT != CNT_REG_EN_PROTECT)) #
(KA_PON_RESET & (CNT_REG_EN_PROTECT_PON_DEFAULT == !CNT_REG_EN_PROTECT)) ) then
!CNT_REG_EN_PROTECT

```

Freescale Semiconductor, Inc.

```

else
    CNT_REG_EN_PROTECT;
state !CNT_REG_EN_PROTECT:
    if (MPC_WRITE_BCSR_3 &
        (CNT_REG_EN_PROTECT_DATA_BIT.pin == CNT_REG_EN_PROTECT) &
        (!KA_PON_RESET # (CNT_REG_EN_PROTECT_PON_DEFAULT != !CNT_REG_EN_PROTECT)) #
        (KA_PON_RESET & (CNT_REG_EN_PROTECT_PON_DEFAULT == CNT_REG_EN_PROTECT)) #
        MPC_WRITE_BCSR_1) then " any write to control reg 1
        CNT_REG_EN_PROTECT
    else
        !CNT_REG_EN_PROTECT;
*****
"* protected by CntRegEnProtect~ to prevent from inadvertant write
*****
state_diagram CntRegEn~
state CONT_REG_ENABLE:
    if (MPC_WRITE_BCSR_1 & (CntRegEnProtect~.fb != CNT_REG_EN_PROTECT) &
        (CONT_REG_ENABLE_DATA_BIT.pin == !CONT_REG_ENABLE) &
        (!KA_PON_RESET # (CONT_REG_ENABLE_PON_DEFAULT != CONT_REG_ENABLE)) #
        (KA_PON_RESET & (CONT_REG_ENABLE_PON_DEFAULT == !CONT_REG_ENABLE)) ) then
        !CONT_REG_ENABLE
    else
        CONT_REG_ENABLE;
state !CONT_REG_ENABLE:" in fact not applicable
    if (MPC_WRITE_BCSR_1 &
        (CONT_REG_ENABLE_DATA_BIT.pin == CONT_REG_ENABLE) &
        (!KA_PON_RESET # (CONT_REG_ENABLE_PON_DEFAULT != !CONT_REG_ENABLE)) #
        (KA_PON_RESET & (CONT_REG_ENABLE_PON_DEFAULT == CONT_REG_ENABLE)) ) then
        CONT_REG_ENABLE
    else
        !CONT_REG_ENABLE;
*****
state_diagram RS232En1~
state RS232_1_ENABLE:
    if (MPC_WRITE_BCSR_1 &
        (RS232_1_ENABLE_DATA_BIT.pin == !RS232_1_ENABLE) &
        (!KA_PON_RESET # (RS232_1_ENABLE_PON_DEFAULT != RS232_1_ENABLE)) #
        (KA_PON_RESET & (RS232_1_ENABLE_PON_DEFAULT == !RS232_1_ENABLE)) ) then
        !RS232_1_ENABLE
    else
        RS232_1_ENABLE;
state !RS232_1_ENABLE:

```

Freescale Semiconductor, Inc.



```

if (MPC_WRITE_BCSR_1 &
(RS232_1_ENABLE_DATA_BIT.pin == RS232_1_ENABLE) &
(!KA_PON_RESET # (RS232_1_ENABLE_PON_DEFAULT != !RS232_1_ENABLE)) #
(KA_PON_RESET & (RS232_1_ENABLE_PON_DEFAULT == RS232_1_ENABLE)) ) then
RS232_1_ENABLE
else
!RS232_1_ENABLE;
*****
state_diagram PccEn~
state PCC_ENABLE:
if (MPC_WRITE_BCSR_1 &
(PCC_ENABLE_DATA_BIT.pin == !PCC_ENABLE) &
(!KA_PON_RESET # (PCC_ENABLE_PON_DEFAULT != PCC_ENABLE)) #
(KA_PON_RESET & (PCC_ENABLE_PON_DEFAULT == !PCC_ENABLE)) ) then
!PCC_ENABLE
else
PCC_ENABLE;
state !PCC_ENABLE:
if (MPC_WRITE_BCSR_1 &
(PCC_ENABLE_DATA_BIT.pin == PCC_ENABLE) &
(!KA_PON_RESET # (PCC_ENABLE_PON_DEFAULT != !PCC_ENABLE)) #
(KA_PON_RESET & (PCC_ENABLE_PON_DEFAULT == PCC_ENABLE)) ) then
PCC_ENABLE
else
!PCC_ENABLE;
*****
state_diagram PccVcc0
state PCC_VCC_CONT_0:
if (MPC_WRITE_BCSR_1 &
(PCC_VCC_0_DATA_BIT.pin == !PCC_VCC_CONT_0) &
(!KA_PON_RESET # (PCC_VCC_0_PON_DEFAULT != PCC_VCC_CONT_0)) #
(KA_PON_RESET & (PCC_VCC_0_PON_DEFAULT == !PCC_VCC_CONT_0)) ) then
!PCC_VCC_CONT_0
else
PCC_VCC_CONT_0;
state !PCC_VCC_CONT_0:
if (MPC_WRITE_BCSR_1 &
(PCC_VCC_0_DATA_BIT.pin == PCC_VCC_CONT_0) &
(!KA_PON_RESET # (PCC_VCC_0_PON_DEFAULT != !PCC_VCC_CONT_0)) #
(KA_PON_RESET & (PCC_VCC_0_PON_DEFAULT == PCC_VCC_CONT_0)) ) then
PCC_VCC_CONT_0
else

```

Freescale Semiconductor, Inc.

```

!PCC_VCC_CONF_0;
*****
state_diagram PccVpp0
state PCC_VPP0:
    if (MPC_WRITE_BCSR_1 &
        (PCC_VPP0_DATA_BIT.pin == !PCC_VPP0) &
        (!KA_PON_RESET # (PCC_VPP0_PON_DEFAULT != PCC_VPP0)) #
        (KA_PON_RESET & (PCC_VPP0_PON_DEFAULT == !PCC_VPP0)) ) then
        !PCC_VPP0
    else
        PCC_VPP0;
state !PCC_VPP0:
    if (MPC_WRITE_BCSR_1 &
        (PCC_VPP0_DATA_BIT.pin == PCC_VPP0) &
        (!KA_PON_RESET # (PCC_VPP0_PON_DEFAULT != !PCC_VPP0)) #
        (KA_PON_RESET & (PCC_VPP0_PON_DEFAULT == PCC_VPP0)) ) then
        PCC_VPP0
    else
        !PCC_VPP0;
*****
state_diagram PccVpp1
state PCC_VPP1:
    if (MPC_WRITE_BCSR_1 &
        (PCC_VPP1_DATA_BIT.pin == !PCC_VPP1) &
        (!KA_PON_RESET # (PCC_VPP1_PON_DEFAULT != PCC_VPP1)) #
        (KA_PON_RESET & (PCC_VPP1_PON_DEFAULT == !PCC_VPP1)) ) then
        !PCC_VPP1
    else
        PCC_VPP1;
state !PCC_VPP1:
    if (MPC_WRITE_BCSR_1 &
        (PCC_VPP1_DATA_BIT.pin == PCC_VPP1) &
        (!KA_PON_RESET # (PCC_VPP1_PON_DEFAULT != !PCC_VPP1)) #
        (KA_PON_RESET & (PCC_VPP1_PON_DEFAULT == PCC_VPP1)) ) then
        PCC_VPP1
    else
        !PCC_VPP1;
*****
state_diagram HalfWord~
state HALF_WORD:
    if (MPC_WRITE_BCSR_1 &

```

Freescale Semiconductor, Inc.



```

(HALF_WORD_DATA_BIT.pin == !HALF_WORD) &
(!KA_PON_RESET # (HALF_WORD_PON_DEFAULT != HALF_WORD)) #
(KA_PON_RESET & (HALF_WORD_PON_DEFAULT == !HALF_WORD)) ) then
!HALF_WORD
else
HALF_WORD;
state !HALF_WORD:
if (MPC_WRITE_BCSR_1 &
(HALF_WORD_DATA_BIT.pin == HALF_WORD) &
(!KA_PON_RESET # (HALF_WORD_PON_DEFAULT != !HALF_WORD)) #
(KA_PON_RESET & (HALF_WORD_PON_DEFAULT == HALF_WORD)) ) then
HALF_WORD
else
!HALF_WORD;
*****
state_diagram RS232En2~
state RS232_2_ENABLE:
if (MPC_WRITE_BCSR_1 &
(RS232_2_ENABLE_DATA_BIT.pin == !RS232_2_ENABLE) &
(!KA_PON_RESET # (RS232_2_ENABLE_PON_DEFAULT != RS232_2_ENABLE)) #
(KA_PON_RESET & (RS232_2_ENABLE_PON_DEFAULT == !RS232_2_ENABLE)) ) then
!RS232_2_ENABLE
else
RS232_2_ENABLE;
state !RS232_2_ENABLE:
if (MPC_WRITE_BCSR_1 &
(RS232_2_ENABLE_DATA_BIT.pin == RS232_2_ENABLE) &
(!KA_PON_RESET # (RS232_2_ENABLE_PON_DEFAULT != !RS232_2_ENABLE)) #
(KA_PON_RESET & (RS232_2_ENABLE_PON_DEFAULT == RS232_2_ENABLE)) ) then
RS232_2_ENABLE
else
!RS232_2_ENABLE;
*****
state_diagram PccVcc1
state PCC_VCC_CONT_0:
if (MPC_WRITE_BCSR_1 &
(PCC_VCC_1_DATA_BIT.pin == !PCC_VCC_CONT_0) &
(!KA_PON_RESET # (PCC_VCC_1_PON_DEFAULT != PCC_VCC_CONT_0)) #
(KA_PON_RESET & (PCC_VCC_1_PON_DEFAULT == !PCC_VCC_CONT_0)) ) then
!PCC_VCC_CONT_0
else
PCC_VCC_CONT_0;

```

Freescale Semiconductor, Inc.



```

state !PCC_VCC_CONT_0:
  if (MPC_WRITE_BCSR_1 &
      (PCC_VCC_1_DATA_BIT.pin == PCC_VCC_CONT_0) &
      (!KA_PON_RESET # (PCC_VCC_1_PON_DEFAULT != !PCC_VCC_CONT_0)) #
      (KA_PON_RESET & (PCC_VCC_1_PON_DEFAULT == PCC_VCC_CONT_0)) ) then
    PCC_VCC_CONT_0
  else
    !PCC_VCC_CONT_0;
*****
state_diagram SdramEn~
  state SDRAM_ENABLED:
    if (MPC_WRITE_BCSR_1 &
        (SDRAM_ENABLE_DATA_BIT.pin == !SDRAM_ENABLED) &
        (!KA_PON_RESET # (SDRAM_ENABLE_PON_DEFAULT != SDRAM_ENABLED)) #
        (KA_PON_RESET & (SDRAM_ENABLE_PON_DEFAULT == !SDRAM_ENABLED)) ) then
      !SDRAM_ENABLED
    else
      SDRAM_ENABLED;
  state !SDRAM_ENABLED:
    if (MPC_WRITE_BCSR_1 &
        (SDRAM_ENABLE_DATA_BIT.pin == SDRAM_ENABLED) &
        (!KA_PON_RESET # (SDRAM_ENABLE_PON_DEFAULT != !SDRAM_ENABLED)) #
        (KA_PON_RESET & (SDRAM_ENABLE_PON_DEFAULT == SDRAM_ENABLED)) ) then
      SDRAM_ENABLED
    else
      !SDRAM_ENABLED;
*****
*****
"* BCSR4 State Machines
*****
*****

state_diagram UsbUtpFethEn~
  state USB_UTP_FETH_ENABLED:
    if (MPC_WRITE_BCSR_4 &
        (USB_UTP_FETH_EN_DATA_BIT.pin == !USB_UTP_FETH_ENABLED) &
        (!KA_PON_RESET # (USB_UTP_FETH_EN_PON_DEFAULT != USB_UTP_FETH_ENABLED)) #
        (KA_PON_RESET & (USB_UTP_FETH_EN_PON_DEFAULT == !USB_UTP_FETH_ENABLED)) ) then
      !USB_UTP_FETH_ENABLED
    else

```

Freescale Semiconductor, Inc.



```

        USB_UTP_FETH_ENABLED;
state !USB_UTP_FETH_ENABLED:
    if (MPC_WRITE_BCSR_4 &
        (USB_UTP_FETH_EN_DATA_BIT.pin == USB_UTP_FETH_ENABLED) &
        (!KA_PON_RESET # (USB_UTP_FETH_EN_PON_DEFAULT != !USB_UTP_FETH_ENABLED)) #
        (KA_PON_RESET & (USB_UTP_FETH_EN_PON_DEFAULT == USB_UTP_FETH_ENABLED)) ) then
        USB_UTP_FETH_ENABLED
    else
        !USB_UTP_FETH_ENABLED;

*****
state_diagram UsbSpeed
state USB_FULL_SPEED:
    if (MPC_WRITE_BCSR_4 &
        (USB_SPEED_DATA_BIT.pin == !USB_FULL_SPEED) &
        (!KA_PON_RESET # (USB_SPEED_PON_DEFAULT != USB_FULL_SPEED)) #
        (KA_PON_RESET & (USB_SPEED_PON_DEFAULT == !USB_FULL_SPEED)) ) then
        !USB_FULL_SPEED
    else
        USB_FULL_SPEED;
state !USB_FULL_SPEED:
    if (MPC_WRITE_BCSR_4 &
        (USB_SPEED_DATA_BIT.pin == USB_FULL_SPEED) &
        (!KA_PON_RESET # (USB_SPEED_PON_DEFAULT != !USB_FULL_SPEED)) #
        (KA_PON_RESET & (USB_SPEED_PON_DEFAULT == USB_FULL_SPEED)) ) then
        USB_FULL_SPEED
    else
        !USB_FULL_SPEED;

*****
state_diagram UsbVcc0
state USB_VCC_CONT_0:
    if (MPC_WRITE_BCSR_4 &
        (USB_VCC_0_DATA_BIT.pin == !USB_VCC_CONT_0) &
        (!KA_PON_RESET # (USB_VCC_0_CONT_PON_DEFAULT != USB_VCC_CONT_0)) #
        (KA_PON_RESET & (USB_VCC_0_CONT_PON_DEFAULT == !USB_VCC_CONT_0)) ) then
        !USB_VCC_CONT_0
    else
        USB_VCC_CONT_0;
state !USB_VCC_CONT_0:
    if (MPC_WRITE_BCSR_4 &

```

Freescale Semiconductor, Inc.



```

(PCC_VCC_0_DATA_BIT.pin == PCC_VCC_CONT_0) &
(!KA_PON_RESET # (USB_VCC_0_CONT_PON_DEFAULT != !USB_VCC_CONT_0)) #
(KA_PON_RESET & (USB_VCC_0_CONT_PON_DEFAULT == USB_VCC_CONT_0)) ) then
USB_VCC_CONT_0
else
!USB_VCC_CONT_0;
*****
state_diagram UsbVcc1
state USB_VCC_CONT_0:
if (MPC_WRITE_BCSR_4 &
(USB_VCC_1_DATA_BIT.pin == !USB_VCC_CONT_0) &
(!KA_PON_RESET # (USB_VCC_1_CONT_PON_DEFAULT != USB_VCC_CONT_0)) #
(KA_PON_RESET & (USB_VCC_1_CONT_PON_DEFAULT == !USB_VCC_CONT_0)) ) then
!USB_VCC_CONT_0
else
USB_VCC_CONT_0;
state !USB_VCC_CONT_0:
if (MPC_WRITE_BCSR_4 &
(PCC_VCC_1_DATA_BIT.pin == PCC_VCC_CONT_0) &
(!KA_PON_RESET # (USB_VCC_1_CONT_PON_DEFAULT != !USB_VCC_CONT_0)) #
(KA_PON_RESET & (USB_VCC_1_CONT_PON_DEFAULT == USB_VCC_CONT_0)) ) then
USB_VCC_CONT_0
else
!USB_VCC_CONT_0;
*****
state_diagram VideoOn~
state VIDEO_ENABLED:
if (MPC_WRITE_BCSR_4 &
(VIDEO_ENABLE_DATA_BIT.pin == !VIDEO_ENABLED) &
(!KA_PON_RESET # (VIDEO_ENABLE_PON_DEFAULT != VIDEO_ENABLED)) #
(KA_PON_RESET & (VIDEO_ENABLE_PON_DEFAULT == !VIDEO_ENABLED)) ) then
!VIDEO_ENABLED
else
VIDEO_ENABLED;
state !VIDEO_ENABLED:
if (MPC_WRITE_BCSR_4 &
(VIDEO_ENABLE_DATA_BIT.pin == VIDEO_ENABLED) &
(!KA_PON_RESET # (VIDEO_ENABLE_PON_DEFAULT != !VIDEO_ENABLED)) #
(KA_PON_RESET & (VIDEO_ENABLE_PON_DEFAULT == VIDEO_ENABLED)) ) then
VIDEO_ENABLED
else

```

Freescale Semiconductor, Inc.





!VIDEO_ENABLED;

state_diagram VideoExtClkEn

state VIDEO_EXT_CLK_ENABLED:

if (MPC_WRITE_BCSR_4 &
(VIDEO_EXT_CLK_EN_DATA_BIT.pin == !VIDEO_EXT_CLK_ENABLED) &
(!KA_PON_RESET # (VIDEO_EXT_CLK_EN_PON_DEFAULT != VIDEO_EXT_CLK_ENABLED)#
(KA_PON_RESET & (VIDEO_EXT_CLK_EN_PON_DEFAULT ==!VIDEO_EXT_CLK_ENABLED)))then
!VIDEO_EXT_CLK_ENABLED

else

VIDEO_EXT_CLK_ENABLED;

state !VIDEO_EXT_CLK_ENABLED:

if (MPC_WRITE_BCSR_4 &
(VIDEO_EXT_CLK_EN_DATA_BIT.pin == VIDEO_EXT_CLK_ENABLED) &
(!KA_PON_RESET # (VIDEO_EXT_CLK_EN_PON_DEFAULT != !VIDEO_EXT_CLK_ENABLED)) #
(KA_PON_RESET & (VIDEO_EXT_CLK_EN_PON_DEFAULT == VIDEO_EXT_CLK_ENABLED))) then
VIDEO_EXT_CLK_ENABLED

else

!VIDEO_EXT_CLK_ENABLED;

state_diagram VideoRst~

state VIDEO_RESET_ACTIVE:

if (MPC_WRITE_BCSR_4 &
(VIDEO_RESET_DATA_BIT.pin == !VIDEO_RESET_ACTIVE) &
(!KA_PON_RESET # (VIDEO_RESET_PON_DEFAULT != VIDEO_RESET_ACTIVE)) #
(KA_PON_RESET & (VIDEO_RESET_PON_DEFAULT == !VIDEO_RESET_ACTIVE))) then
!VIDEO_RESET_ACTIVE

else

VIDEO_RESET_ACTIVE;

state !VIDEO_RESET_ACTIVE:

if (MPC_WRITE_BCSR_4 &
(VIDEO_RESET_DATA_BIT.pin == VIDEO_RESET_ACTIVE) &
(!KA_PON_RESET # (VIDEO_RESET_PON_DEFAULT != !VIDEO_RESET_ACTIVE)) #
(KA_PON_RESET & (VIDEO_RESET_PON_DEFAULT == VIDEO_RESET_ACTIVE))) then
VIDEO_RESET_ACTIVE

else

!VIDEO_RESET_ACTIVE;

state_diagram SignalLamp~

state SIGNAL_LAMP_ON:

if (MPC_WRITE_BCSR_4 &

```

(SIGNAL_LAMP_DATA_BIT.pin == !SIGNAL_LAMP_ON) &
(!KA_PON_RESET # (SIGNAL_LAMP_PON_DEFAULT != SIGNAL_LAMP_ON)) #
(KA_PON_RESET & (SIGNAL_LAMP_PON_DEFAULT == !SIGNAL_LAMP_ON)) ) then
!SIGNAL_LAMP_ON
else
SIGNAL_LAMP_ON;
state !SIGNAL_LAMP_ON:
if (MPC_WRITE_BCSR_4 &
(SIGNAL_LAMP_DATA_BIT.pin == SIGNAL_LAMP_ON) &
(!KA_PON_RESET # (SIGNAL_LAMP_PON_DEFAULT != !SIGNAL_LAMP_ON)) #
(KA_PON_RESET & (SIGNAL_LAMP_PON_DEFAULT == SIGNAL_LAMP_ON)) ) then
SIGNAL_LAMP_ON
else
!SIGNAL_LAMP_ON;
*****
state_diagram EthLoop
state ETH_LOOP:
if (MPC_WRITE_BCSR_4 &
(ETH_LOOP_DATA_BIT.pin == !ETH_LOOP) &
(!KA_PON_RESET # (ETH_LOOP_PON_DEFAULT != ETH_LOOP)) #
(KA_PON_RESET & (ETH_LOOP_PON_DEFAULT == !ETH_LOOP)) ) then
!ETH_LOOP
else
ETH_LOOP;
state !ETH_LOOP:
if (MPC_WRITE_BCSR_4 &
(ETH_LOOP_DATA_BIT.pin == ETH_LOOP) &
(!KA_PON_RESET # (ETH_LOOP_PON_DEFAULT != !ETH_LOOP)) #
(KA_PON_RESET & (ETH_LOOP_PON_DEFAULT == ETH_LOOP)) ) then
ETH_LOOP
else
!ETH_LOOP;
*****
state_diagram TPFIDL~
state ETH_FULL_DUP:
if (MPC_WRITE_BCSR_4 &
(ETH_FULL_DUP_DATA_BIT.pin == !ETH_FULL_DUP) &
(!KA_PON_RESET # (ETH_FULL_DUP_PON_DEFAULT != ETH_FULL_DUP)) #
(KA_PON_RESET & (ETH_FULL_DUP_PON_DEFAULT == !ETH_FULL_DUP)) ) then
!ETH_FULL_DUP
else
ETH_FULL_DUP;

```

Freescale Semiconductor, Inc.



```

state !ETH_FULL_DUP:
  if (MPC_WRITE_BCSR_4 &
      (ETH_FULL_DUP_DATA_BIT.pin == ETH_FULL_DUP) &
      (!KA_PON_RESET # (ETH_FULL_DUP_PON_DEFAULT != !ETH_FULL_DUP)) #
      (KA_PON_RESET & (ETH_FULL_DUP_PON_DEFAULT == ETH_FULL_DUP)) ) then
    ETH_FULL_DUP
  else
    !ETH_FULL_DUP;
*****
state_diagram TPSQEL~
state ETH_CLSN_TEST:
  if (MPC_WRITE_BCSR_4 &
      (ETH_CLSN_TEST_DATA_BIT.pin == !ETH_CLSN_TEST) &
      (!KA_PON_RESET # (ETH_CLSN_TEST_PON_DEFAULT != ETH_CLSN_TEST)) #
      (KA_PON_RESET & (ETH_CLSN_TEST_PON_DEFAULT == !ETH_CLSN_TEST)) ) then
    !ETH_CLSN_TEST
  else
    ETH_CLSN_TEST;
state !ETH_CLSN_TEST:
  if (MPC_WRITE_BCSR_4 &
      (ETH_CLSN_TEST_DATA_BIT.pin == ETH_CLSN_TEST) &
      (!KA_PON_RESET # (ETH_CLSN_TEST_PON_DEFAULT != !ETH_CLSN_TEST)) #
      (KA_PON_RESET & (ETH_CLSN_TEST_PON_DEFAULT == ETH_CLSN_TEST)) ) then
    ETH_CLSN_TEST
  else
    !ETH_CLSN_TEST;
*****
state_diagram ModemEn~
state MODEM_ENABLED_FOR_823:
  if (MPC_WRITE_BCSR_4 &
      (MODEM_ENABLE_DATA_BIT.pin == !MODEM_ENABLED_FOR_823) &
      (!KA_PON_RESET # (MODEM_ENABLE_PON_DEFAULT != MODEM_ENABLED_FOR_823)) #
      (KA_PON_RESET & (MODEM_ENABLE_PON_DEFAULT == !MODEM_ENABLED_FOR_823)) ) then
    !MODEM_ENABLED_FOR_823
  else
    MODEM_ENABLED_FOR_823;
state !MODEM_ENABLED_FOR_823:
  if (MPC_WRITE_BCSR_4 &
      (MODEM_ENABLE_DATA_BIT.pin == MODEM_ENABLED_FOR_823) &
      (!KA_PON_RESET # (MODEM_ENABLE_PON_DEFAULT != !MODEM_ENABLED_FOR_823)) #
      (KA_PON_RESET & (MODEM_ENABLE_PON_DEFAULT == MODEM_ENABLED_FOR_823)) ) then
    MODEM_ENABLED_FOR_823

```

Freescale Semiconductor, Inc.

```

else
    !MODEM_ENABLED_FOR_823;
*****
state_diagram Modem_Audio~
state MODEM:
    if (MPC_WRITE_BCSR_4 &
        (MODEM_FUNC_SEL_DATA_BIT.pin == !MODEM) &
        (!KA_PON_RESET # (MODEM_FUNC_SEL_PON_DEFAULT != MODEM)) #
        (KA_PON_RESET & (MODEM_FUNC_SEL_PON_DEFAULT == !MODEM)) ) then
        !MODEM
    else
        MODEM;
state !MODEM:
    if (MPC_WRITE_BCSR_4 &
        (MODEM_FUNC_SEL_DATA_BIT.pin == MODEM) &
        (!KA_PON_RESET # (MODEM_FUNC_SEL_PON_DEFAULT != !MODEM)) #
        (KA_PON_RESET & (MODEM_FUNC_SEL_PON_DEFAULT == MODEM)) ) then
        MODEM
    else
        !MODEM;
*****
*****
" External Read Registers' Chip-Selects
*****
*****
equations
Bcsr2_3Cs~.oe = 3;
!Bcsr2Cs~ = MPC_READ_BCSR_2;
!Bcsr3Cs~ = MPC_READ_BCSR_3;
*****
*****
"* Read Registers.
"* All registers have read capabilty.
*****
*****
equations
DataOe = MPC_READ_BCSR_0 #
        MPC_READ_BCSR_1 #
        MPC_READ_BCSR_4 #

```

Freescale Semiconductor, Inc.

PRELIMINARY



```

RESET_CONFIG_DRIVEN;

Data.oe = DataOe;
" Data.oe = ^hffff;

when (MPC_READ_BCSR_0 #
RESET_CONFIG_DRIVEN) then
Data = [ERB.fb,IP~.fb,RSV2.fb,BDIS.fb,BPS0.fb,BPS1.fb,RSV6.fb,
ISB0.fb,ISB1.fb,DBGC0.fb,DBGC1.fb,DBPC0.fb,DBPC1.fb,
RSV13.fb,RSV14.fb,RSV15.fb];
else when (MPC_READ_BCSR_1) then
Data = ReadBcsr1;
else when (MPC_READ_BCSR_4) then
" Data = [UsbUtpFethEn~,UsbSpeed,UsbVcc0, UsbVcc1, VideoOn~,VideoExtClkEn,
" VideoRst~,Signalamp~,EthLoop,TPFLDL~,TPSQEL~,Modem_Audio~,0,0,0,0];
Data = [EthLoop,TPFLDL~,TPSQEL~,Signalamp~,UsbUtpFethEn~,Usb
Speed,UsbVcc0,
UsbVcc1, VideoOn~,VideoExtClkEn,VideoRst~,Mode-
mEn~,Modem_Audio~,0,0,0];

end bcsr10
"*****

```

Freescale Semiconductor, Inc.

PRELIMINARY

A•3 U22 - Auxiliary Board Control

```

*****
*****
"* In this file (5):
"* 1) The use of BCLOSE~ is removed. This due to the assignment
"*   BCLOSE~ to GPL4A. In order of using of GPL4A bit in the upm to determine
"*   data sampling edge, GPL4A may not be used as a GPL. Therefore DramBankXCcs~
"*   must envelope the cycle so that data buffers remain open throughout the
"*   cycle.
"* 2) Removed CS support for flash configuration. I.e., FlashCsl~ will not be
"*   asserted during hard reset. Flash configuration will be supported on
"*   silicon next revisions.
"*   data buffers will still open for flash configuration when hard reset
"*   asserted and flash configuration option bit, asserted.
"* 3) Since Bclose~ is no longer available, the data buffers will open
"*   asynchronously. I.e., driven directly by the various chip-selects.
"*   to provide data hold (0) on write cycles to flash, CSNT bit in the OR
"*   should be programmed active, while ACS == 00.
*****
"* In This file (6), A12 and A11 are removed from the flash selection equation
"* since they can select only a 1/2 Mbyte of flash rather than 2Mbyte selection
"* needed. Therefore, only one bank of 2 Mbyte flash may be used (MCM29F020).
"* The rest of the CS are driven high constantly.
*****
"* In this file (7):
"* - Pon Reset Out is removed. Pon Reset is driven directly to MPC.
"* - Modck0 becomes Modck2
"* - A9 and A10 replace A11 and A12 in flash bank selection
"* - Optional BufClose~ is removed.
"* - DramEn becomes active-low to support debug-station support changes.
"* - Added F_PD(1:3) to support SMART Flash SIMMs.
"* - Support for 32KHz crystal - renewed.
*****
"* In this file (8):
"* - Added protection against data contention for write cycles after
"*   Flash read cycle. This is achieved using a state-machine which identifies
"*   end of flash read and a chain of internal gates serving as a delay line.
"*   This kind of solution guaranties a fixed delay over the data buffer enable
"*   signal, that is, only after a flash read cycle.
*****
"* In this file (9):

```

Freescale Semiconductor, Inc.



```

"* - The addressing scheme of the flash is changed so that the bank does
"* not occupy a space bigger than its real size. I.e. A9 and A10 use
"* is conditioned with the module type.

```

```

*****

```

```

" In this file (10):

```

```

"* - A bug is fixed in Smart flash memories presence detect encoding:
"* for SM732A1000A - F_PD == 5 (was 2)
"* for SM732A2000 - F_PD == 4 (was 3)

```

```

*****

```

```

"* In this file (11):

```

```

"* - KAPORIn (power-on reset input) line is removed. It was unused previously.
"* - Instead of the the above, F_PD4 input is added, so exact identification
"* may be given to any flash memory.
"* - Number of delay stages for flash turn-off time protection is decreased
"* This to avoid possible problem in write to 0-w.s. memories.

```

```

*****

```

```

"* In This file (12):

```

```

"* - Added ATA support for PCMCIA. I.e., PccEvenEn~ and PccOddEn~ become
"* identical, enabled by logic OR of CE1~ and CE2~

```

```

*****

```

```

module brdctl12

```

```

title 'MPC821ADS Board Misc. Control Functions.

```

```

    Originated for MPC821ADS, Yair Liebman - (MSIL) - April 10, 1995'

```

```

*****

```

```

"* Device declaration.

```

```

*****

```

```

U22 device 'mach220a';

```

```

*****

```

```

"* #####      *
"* #          # # ##### ##### # # ## #      ## #
"* #          # # # # # # # # # # # # # # # # #
"* #####      ## # ##### # # # # # # # # # # # #
"* #          ## # # ##### # # # ##### # # # #
"* #          # # # # # # # # # # # # # # # # # #
"* ##### # # # # ##### # # # # # # # # # # # #

```

```

*****

```

Freescale Semiconductor, Inc.

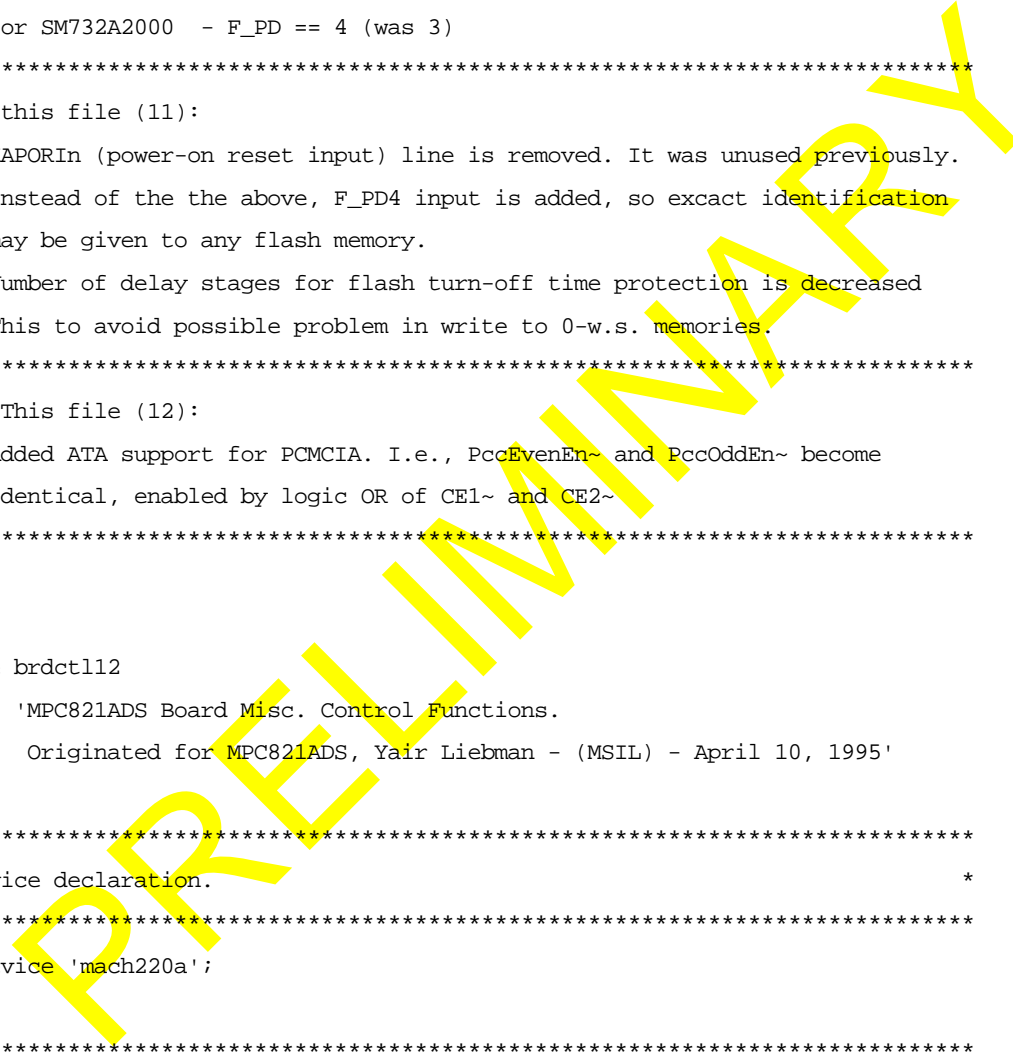

```

*****
"* Pins declaration.                                     *
*****

*****
"* clock generator
*****

SYSCLKPIN 50;" pda clkout

*****
"* Dram Associated Pins.
*****

A9  PIN 55;
A10 PIN 39;
A19 PIN 38;
A20 PIN 2;
A30 PIN 36;" pda address lines inputs (IN)

R_W~ PIN 23;

SizeDetect1PIN 26;
SizeDetect0PIN 20;" dram simm size detect lines (IN)

HalfWord~PIN 51;" dram port width selection from control register:
    " '1' - 32 bit
    " '0' - 16 bit
DramBank1Cs~PIN 45;" 1'st bank chip-select(IN, L)
DramBank2Cs~PIN 46;" 2'nd bank chip-select (IN, L)

DramEn~PIN 54;" Dram enable from control reg. (IN, H). Active
    " high to support power control.

DramAdd10PIN 32 istype 'com';
DramAdd9PIN 33 istype 'com';" dram address lines

Ras1~PIN 28 istype 'com';
Ras1DD~PIN 30 istype 'com';
Ras2~PIN 29 istype 'com';
Ras2DD~PIN 31 istype 'com';" dram RAS lines.

```

Freescale Semiconductor, Inc.



```

*****
"* Flash Associated Pins.
*****

F_PD1PIN 7;
F_PD2PIN 65;
F_PD3PIN 41;
F_PD4PIN 25;

FlashCs~ PIN 49;" flash bank chip-select
FlashEn~PIN 15;" flash enable from control reg.

FlashCs1~PIN 12 istype 'com';" Flash bank1 chip-select
FlashCs2~PIN 22 istype 'com';" Flash bank2 chip-select
FlashCs3~PIN 57 istype 'com';" Flash bank3 chip-select
FlashCs4~PIN 24 istype 'com';" Flash bank4 chip-select

FlashOe~PIN 58 istype 'com';" Flash output enable.

*****
"* Control Register pins
*****
ContRegCs~PIN 59;" control register cs from MPC8XX
ContRegEn~PIN 56;" control register enable from control register.

*****
"* Reset & Interrupt Logic Pins.
*****

Rst0 PIN 13; " connected to N.C. of Reset P.B.
Rst1 PIN 21; " connected to N.O. of Reset P.B.

!RegPORIn~PIN 9; " Regular Power On Reset In. (H)

HardReset~PIN 48 istype 'com'; " Actual hard reset output (O.D.)
SoftReset~PIN 40 istype 'com'; " Actual soft reset output (O.D.)
ResetConfig~PIN 67 istype 'com'; " Drives the RSTCONF* signal of the MPC8XX.
DriveConfig~PIN 63 istype 'com';" Drives configuration data to the MPC8XX

Abr0 PIN 10; " connected to N.C. of Abort P.B.
Abr1 PIN 11; " connected to N.O. of Abort P.B.

NMIEnNODE istype 'com'; " enables T.S. NMI pin

```

Freescale Semiconductor, Inc.



```

*****

*****

"* Reset & Interrupt Logic Pins.
*****

RstDeblNODE istype 'com';    " reset push button debouncer
AbrDeblNODE istype 'com';    " abort push button debouncer

HardResetEnNODE istype 'com';    " enables T.S. hard reset pin
SoftResetEnNODE istype 'com';    " enables T.S. soft reset pin

ConfigHold2,
ConfigHold1,
ConfigHold0node istype 'reg,buffer';" supplies data hold time for
                                " hard reset configuration

ConfigHoldEndnode istype 'com';
*****

"* data buffers enable.
*****

SyncHardReset~NODE istype 'reg,buffer';    " synchronized hard reset
DSyncHardReset~  NODE istype 'reg,buffer';" double synchronized hard reset

SyncTEA~NODE istype 'reg,buffer';    " needed since TEA~ is O.D.

HoldOffConsidered NODE istype 'reg,buffer';" data drive hold-off state
                                " machine.

D_FlashOe~NODE istype 'com';    " delayed flash output enable
DD_FlashOe~NODE istype 'com';" double delayed flash output
                                " enable
TD_FlashOe~NODE istype 'com';" triple delayed flash output
                                " enable

" QD_FlashOe~NODE istype 'com';    quad delayed
" PD_FlashOe~NODE istype 'com';    penta delayed

KeepPinsConnected node istype 'com';

*****

"* #####
"* #      #      #####  #      #      #####  #####  ##      #      #      #####
"* #      #      #      ##  #      #      #      #      ##  #      #      #

```



```

"* # # # # # ##### # # # # # # #
"* # # # # # # # # # # # # # #
"* # # # # # # # # # # # # # #
"* ##### # # # # # # # # # # #
"*
"* #####
"* # # ##### # # # # # # # #
"* # # # # # # # # # # # #
"* # # ##### # # # # # # # #
"* # # # # # # # # # # # # #
"* # # # # # # # # # # # #
"* ##### # # # # # # # # # #
"*
"* # # # # # # # # # # # #
"* # # # # # # # # # # # #
"* # # # # # # # # # # # #
"* ##### # # # # # # # # # #
"* # # # # # # # # # # # #
"* # # # # # # # # # # # #

```

H, L, X, Z = 1, 0, .X., .Z.;
 C, D, U = .C., .D., .U.;

```

"* SLOW_32K_LOCK = 1;
*****
"* Signal groups
*****
PdaAdd = [A9,A10,A19,A20,A30];
DramAdd = [DramAdd10,DramAdd9];
DramCS~ =[DramBank2Cs~,DramBank1Cs~];
RAS = [Ras1~,Ras1DD~,Ras2~,Ras2DD~];
SD = [SizeDetect1,SizeDetect0];
FlashCsOut = [FlashCs4~,FlashCs3~,FlashCs2~,FlashCs1~];
Reset = [HardReset~,SoftReset~];
ResetEn = [HardResetEn,SoftResetEn];
Rst = [Rst1,Rst0];
Abr = [Abr1,Abr0];
Debounce = [RstDeb1,AbrDeb1];
DramCs = [DramBank2Cs~,DramBank1Cs~];
Cs = [ContRegCs~,FlashCs~,DramBank1Cs~,DramBank2Cs~];
PccCs = [PccCE1~,PccCE2~];

```

```

LocDataBufEn = [UpperHalfEn~,LowerHalfEn~];
PccDataBufEn = [PccEvenEn~,PccOddEn~];
ModuleEn = [DramEn~,FlashEn~,PccEn~,ContRegEn~];
SyncReset = [SyncHardReset~,DSyncHardReset~];
RstCause = [Rst1,Rst0,Abr1,Abr0,RegPORIn~];
Stp = [TA~];
Modck = [Modck2, Modck1];
ConfigHold =[ConfigHold2, ConfigHold1, ConfigHold0];
F_PD = [F_PD4, F_PD3, F_PD2, F_PD1];
*****
"* Dram Declarations.
*****
DRAM_ENABLE_ACTIVE = 0;

DRAM_ENABLED = (DramEn~ == DRAM_ENABLE_ACTIVE);

SIMM36100 = (SD == 0);
SIMM36200 = (SD == 3);
SIMM36400 = (SD == 2);
SIMM36800 = (SD == 1);

IS_HALF_WORD = (HalfWord~ == 0);

*****
"* Flash Declarations.
*****
FLASH_ENABLE_ACTIVE = 0;

FLASH_ENABLED = (FlashEn~ == FLASH_ENABLE_ACTIVE);

MCM29020 = (F_PD == 8);
MCM29040 = (F_PD == 7);
MCM29080 = (F_PD == 6);
SM732A1000A = (F_PD == 5);
SM732A2000 = (F_PD == 4);

FLASH_BANK1 = ( (MCM29020 # SM732A1000A) #
                (MCM29040 & !A10) #
                (MCM29080 & !A9 & !A10) #
                (SM732A2000 & !A9) );

FLASH_BANK2 = ( (MCM29040 & A10) #

```

Freescale Semiconductor, Inc.

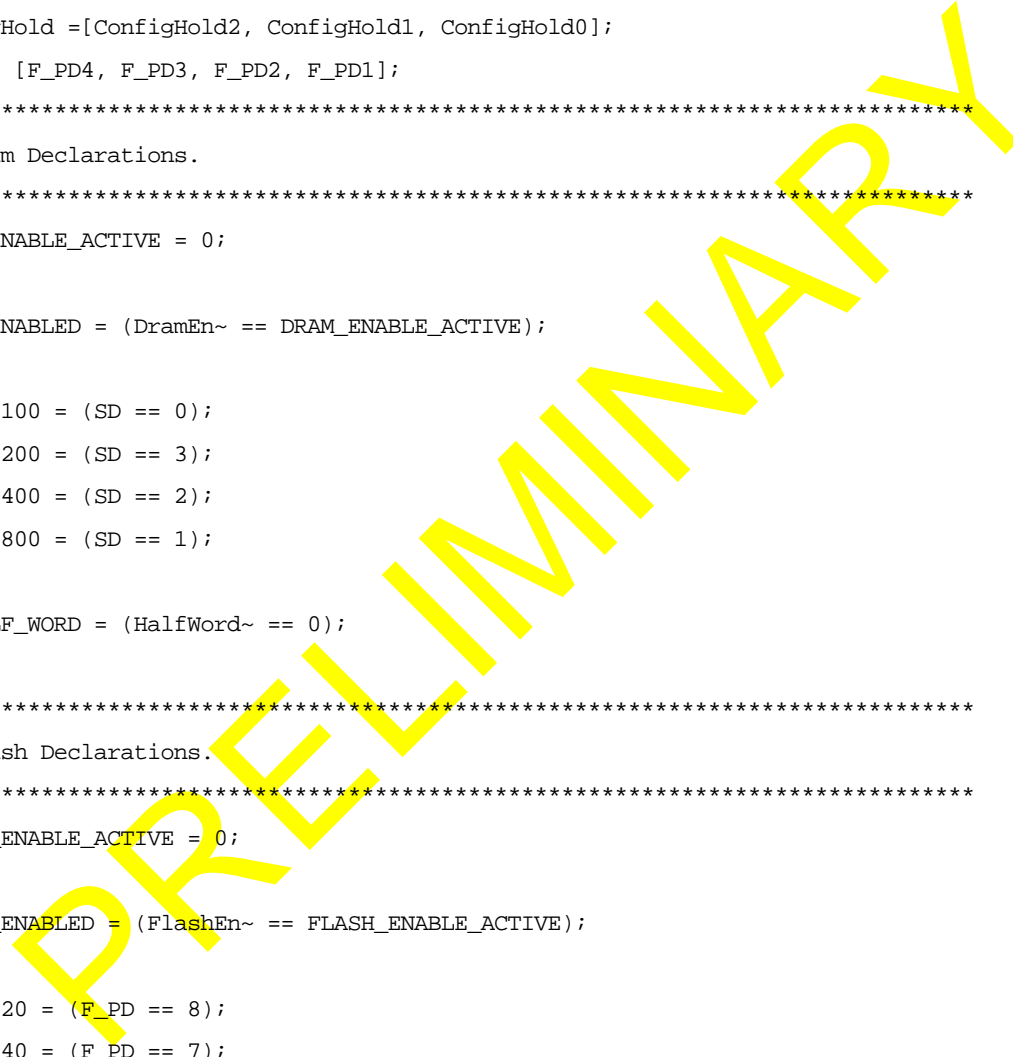

PRELIMINARY

```
(MCM29080 & !A9 & A10) #
(SM732A2000 & A9) );
```

```
FLASH_BANK3 = (A9 & !A10 & MCM29080);
```

```
FLASH_BANK4 = (A9 & A10 & MCM29080);
```

```
*****
"* Reset Declarations.
```

```
*****
```

```
KEEP_ALIVE_PON_RESET_ACTIVE = 0;
```

```
REGULAR_PON_RESET_ACTIVE = 0;
```

```
HARD_RESET_ACTIVE = 0;
```

```
SOFT_RESET_ACTIVE = 0;
```

```
HARD_CONFIG_HOLD_VALUE = 4;
```

```
DRIVE_MODCK_TO_PDA = (HardReset~ == HARD_RESET_ACTIVE);" have modck stable
" during hard reset.
```

```
REGULAR_POWER_ON_RESET = (RegPORIn~ == REGULAR_PON_RESET_ACTIVE);
```

```
HARD_RESET_ASSERTED = (SyncHardReset~.fb == HARD_RESET_ACTIVE);
```

```
HARD_RESET_NEGATES = ( (SyncHardReset~.fb != HARD_RESET_ACTIVE )
& (DSyncHardReset~.fb == HARD_RESET_ACTIVE));
" detecting hard reset negation
```

```
*****
```

```
"* data buffers enable.
```

```
*****
```

```
BUFFER_DISABLED = 1;
```

```
BUFFER_ENABLED = !BUFFER_DISABLED;
```

```
CONTROL_REG_ENABLE_ACTIVE = 0;
```

```
FLASH_CONFIG_ENABLED_ACTIVE = 0;
```

```
PCMCIA_ENABLE_ACTIVE = 0;
```

```
GPL_ACTIVE = 0;
```



```

TEA_ASSERTS = (!TEA~ & SyncTEA~.fb);" first clock of TEA~ asserted

CONTROL_REG_ENABLED = (ContRegEn~ == CONTROL_REG_ENABLE_ACTIVE);

FLASH_CONFIGURATION_ENABLED = (FlashCfgEn~ == FLASH_CONFIG_ENABLED_ACTIVE);

PCC_ENABLED = (PccEn~ == PCMCIA_ENABLE_ACTIVE);

NO_HOLD_OFF = 0;
HOLD_OFF_CONSIDERED = 1;

STATE_HOLD_OFF_CONSIDERED = (HoldOffConsidered.fb == HOLD_OFF_CONSIDERED);
STATE_NO_HOLD_OFF = (HoldOffConsidered.fb == NO_HOLD_OFF);

END_OF_FLASH_READ = !TA~ & !FlashCs~ & R_W~;" end of flash read cycle.
END_OF_OTHER_CYCLE = (!TA~ & FlashCs~ # " another access or
    !TA~ & !FlashCs~ & !R_W~); " flash write

"* HOLD_OFF_PERIOD = (!R_W~ & !PD_FlashOe~.fb);
HOLD_OFF_PERIOD = (!R_W~ & !TD_FlashOe~.fb);

*****
"* Equations, state diagrams.
*****
"*
"* #####
"* # ##### # # ## ##### # ##### # # # # #
"* # # # # # # # # # # # # # # # # #
"* ##### # # # # # # # # # # # # # # # # # # # # # # #
"* # # # # # # # # # # # # # # # # # # # # # # #
"* # # # # # # # # # # # # # # # # # # # # # # #
"* ##### # # # # # # # # # # # # # # # # # # # # # # #
"*
*****
"* Reset Logic
*****
equations

Reset.oE = ResetEn;

```

Freescale Semiconductor, Inc.

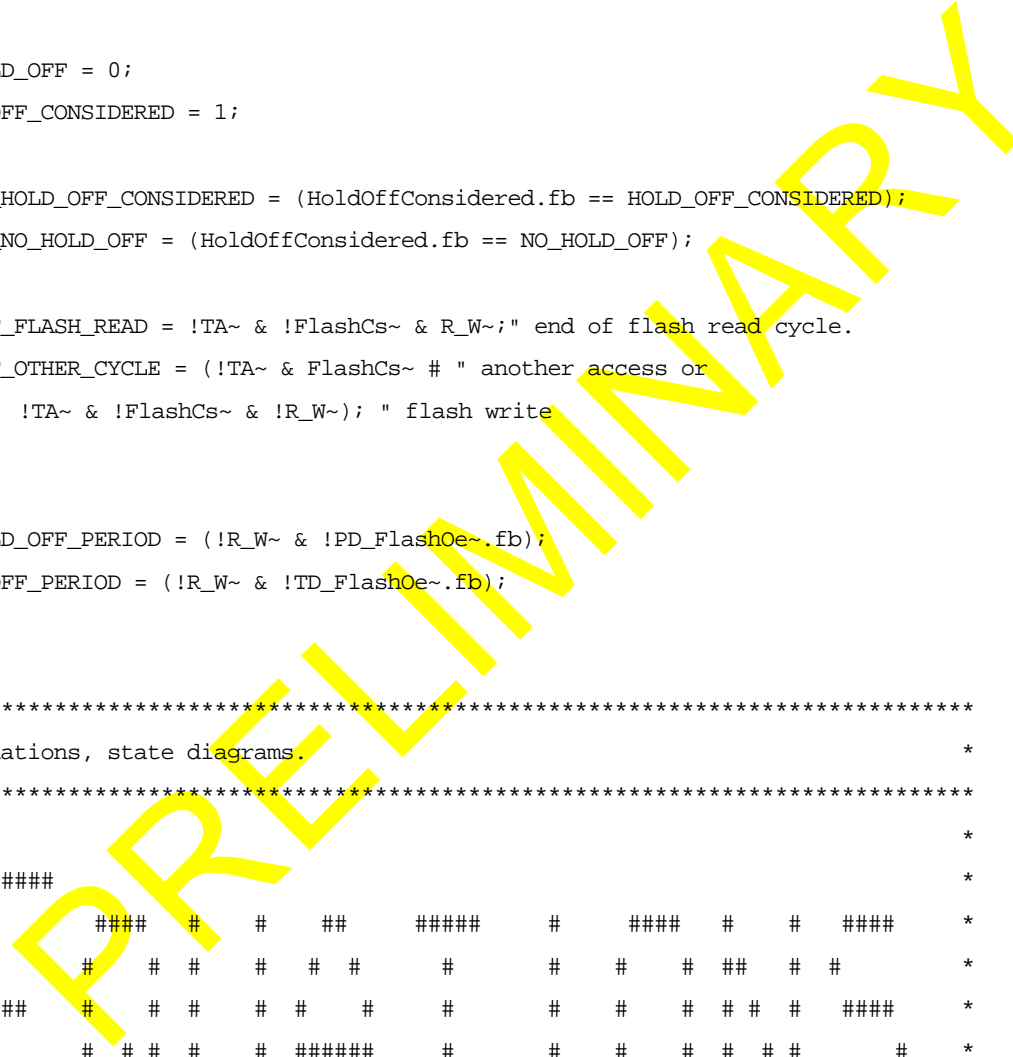

```

Reset = 0;" open drain

RstDebl = !( Rst1 & (!( RstDebl.fb & Rst0) ) );    " Reset push-button debouncer

AbrDebl = !( Abr1 & (!( AbrDebl.fb & Abr0) ) );    " Abort push-button debouncer

HardResetEn = RstDebl.fb & AbrDebl.fb " both buttons are depressed;
                # REGULAR_POWER_ON_RESET;

SoftResetEn = RstDebl.fb & !AbrDebl.fb;" only reset button depressed

*****
"* Power On reset configuration
*****
equations

Modck.oe = ModckOe;

ModckOe = DRIVE_MODCK_TO_PDA;

Modck2 = L;
#ifdef SLOW_32K_LOCK {

    Modck2 = ModIn;" support for 1:513 (32KHz crystal) or
    Modck1 = ModIn;" 1:5 (5MHz clock gen.) via CLK4IN
}

#ifdef SLOW_32K_LOCK {

    Modck2 = !ModIn;" support for 1:1 or 1:5 from CLK4IN only
    Modck1 = H;" no support for 32K oscillator.
}

*****
"* Hard reset configuration
*****
equations

ResetConfig~.oe = H;
DriveConfig~.oe = H;
    
```

Freescale Semiconductor, Inc.

PRELIMINARY



```

"* Configuration hold counter. Since the rise time of the HARD RESET signal
"* is relatively slow, there is a need to provide a hold time for reset
"* configuration.

```

```

ConfigHold.clk = SYSCLK;

```

```

when (SyncHardReset~.fb & !ConfigHoldEnd.fb) then ConfigHold := ConfigHold.fb +1;
else when (SyncHardReset~.fb & ConfigHoldEnd.fb) then ConfigHold := ConfigHold.fb;
else when (!SyncHardReset~.fb) then ConfigHold := 0;

```

```

ConfigHoldEnd = (ConfigHold.fb == HARD_CONFIG_HOLD_VALUE); " terminal count

```

```

!ResetConfig~ = !HardReset~;" drives RSTCONF~ to MPC8XX

```

```

!DriveConfig~ = !ConfigHoldEnd.fb; " drives configuration data on the bus.

```

```

*****
"* NMI generation
*****

```

```

equations

```

```

NMI~.oe = NMIEn;

```

```

NMI~ = 0;" O.D.

```

```

NMIEn = !RstDebl.fb & AbrDebl.fb;" only abort button depressed

```

```

*****
"* local data buffers enable
*****

```

```

equations

```

```

SyncHardReset~.clk = SYSCLK;

```

```

DSyncHardReset~.clk = SYSCLK;

```

```

SyncHardReset~ := HardReset~;

```

```

DSyncHardReset~ := SyncHardReset~.fb;

```

```

SyncTEA~.clk = SYSCLK;

```

```

SyncTEA~ := TEA~;

```

```

LocDataBufEn.oe = 3;

```

Freescale Semiconductor, Inc.

```
!UpperHalfEn~ = (!DramBank1Cs~ & DRAM_ENABLED #
                !DramBank2Cs~ & (SIMM36200 # SIMM36800) & DRAM_ENABLED #
                !FlashCs~ & FLASH_ENABLED #
                !ContRegCs~ & CONTROL_REG_ENABLED #
                !PccCE1~ & PCC_ENABLED #
                !PccCE2~ & PCC_ENABLED #
                !ConfigHoldEnd.fb) &
                (STATE_HOLD_OFF_CONSIDERED & (!HOLD_OFF_PERIOD) #
                STATE_NO_HOLD_OFF);
```

```
!LowerHalfEn~ = (!DramBank1Cs~ & DRAM_ENABLED & !IS_HALF_WORD #
                !DramBank2Cs~ & (SIMM36200 # SIMM36800) &
                !IS_HALF_WORD & DRAM_ENABLED #
                !FlashCs~ & FLASH_ENABLED #
                !ConfigHoldEnd.fb & FLASH_CONFIGURATION_ENABLED) &
                (STATE_HOLD_OFF_CONSIDERED & !HOLD_OFF_PERIOD #
                STATE_NO_HOLD_OFF);
```

* local data buffers disable (data contention protection)

equations

HoldOffConsidered.clk = SYSCLK;

D_FlashOe~ = FlashOe~;

DD_FlashOe~ = D_FlashOe~.fb;

TD_FlashOe~ = DD_FlashOe~.fb;

* QD_FlashOe~ = TD_FlashOe~.fb;

* PD_FlashOe~ = QD_FlashOe~.fb;

@ifdef DEBUG {

equations

HoldOffConsidered := HOLD_OFF_CONSIDERED;

}

@ifndef DEBUG {

state_diagram HoldOffConsidered

state NO_HOLD_OFF:



```

    if (END_OF_FLASH_READ & DSyncHardReset~.fb) then
        HOLD_OFF_CONSIDERED
    else
        NO_HOLD_OFF;
state HOLD_OFF_CONSIDERED:
    if (END_OF_OTHER_CYCLE # !DSyncHardReset~.fb) then
        NO_HOLD_OFF
    else
        HOLD_OFF_CONSIDERED;
}

*****
"* pcc data buffers enable
*****
equations

PccDataBufEn.oe = 3;

!PccEvenEn~ = (!PccCE1~ # !PccCE2~) & PCC_ENABLED & !HARD_RESET_ASSERTED &
    (STATE_HOLD_OFF_CONSIDERED & HOLD_OFF_PERIOD #
    STATE_NO_HOLD_OFF);
!PccOddEn~ = (!PccCE1~ # !PccCE2~) & PCC_ENABLED & !HARD_RESET_ASSERTED &
    (STATE_HOLD_OFF_CONSIDERED & HOLD_OFF_PERIOD #
    STATE_NO_HOLD_OFF);

*****
"* pcc data buffers direction
*****
equations

PccR_W~.oe = H;

PccR_W~ = R_W~;

*****
"* Dram Address lines.
"* These lines are conected to the dram high order address lines A9 and A10
"* (if available). These lines change value according to the dram size and
"* port size.
"* The dram size is encoded from the presence detect lines (see definitions
"* above) and the port size is determined by the control register.

```

Freescale Semiconductor, Inc.



equations

DramAdd.oe = 3;

when (!IS_HALF_WORD # IS_HALF_WORD & (SIMM36400 # SIMM36800)) then

 DramAdd9 = A20;

else

 DramAdd9 = A30;

when ((SIMM36400 # SIMM36800) & !IS_HALF_WORD) then

 DramAdd10 = A19;

else when ((SIMM36400 # SIMM36800) & IS_HALF_WORD) then

 DramAdd10 = A30;

else

 DramAdd10 = 0;

* RAS generation.

* Since the dram simm requires RAS signals to be split due to high capacitive

* load and to allow 16 bit operation. When working with 16 bit port size,

* the double drive RAS signals are disabled.

equations

RAS.oe = ^hf;

!Ras1~ = !DramBank1Cs~ & DramBank2Cs~ & DRAM_ENABLED;

!Ras2~ = !DramBank2Cs~ & DramBank1Cs~ & DRAM_ENABLED & (SIMM36200 # SIMM36800);

!Ras1DD~ = !DramBank1Cs~ & DramBank2Cs~ & DRAM_ENABLED;

!Ras2DD~ = !DramBank2Cs~ & DramBank1Cs~ & DRAM_ENABLED & (SIMM36200 # SIMM36800);

* Flash Chip Select

equations

FlashCsOut.oe = ^hf;

!FlashCs1~ = FLASH_ENABLED & !FlashCs~ & FLASH_BANK1;

!FlashCs2~ = FLASH_ENABLED & !FlashCs~ & FLASH_BANK2 ;

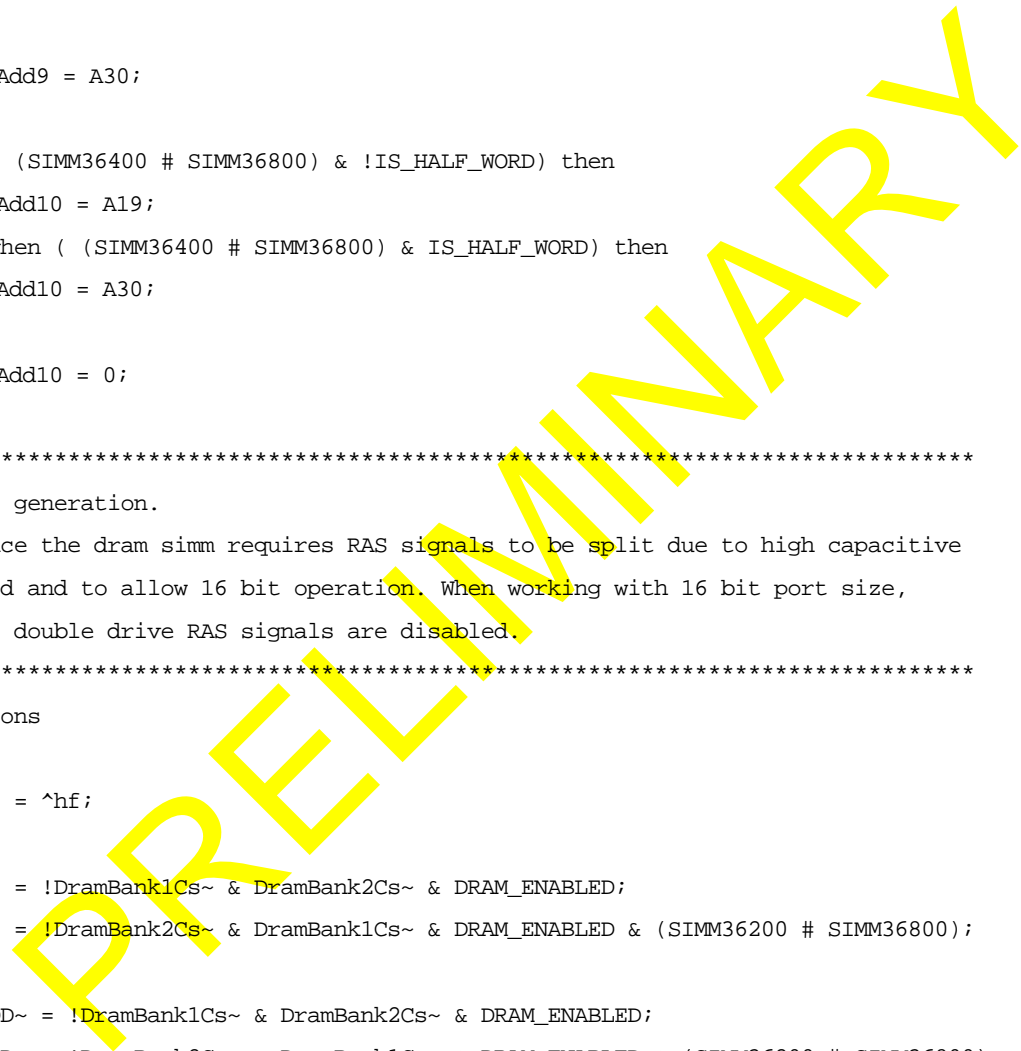



```
!FlashCs3~ = FLASH_ENABLED & !FlashCs~ & FLASH_BANK3 ;
!FlashCs4~ = FLASH_ENABLED & !FlashCs~ & FLASH_BANK4 ;
```

```
FlashOe~.oe = H;
```

```
!FlashOe~ = FLASH_ENABLED & R_W~;
```

```
*****
```

```
"* Auxiliary functions
```

```
*****
```

```
equations
```

```
KeepPinsConnected = TA~ ;
```

```
end brdctl12
```

```
*****
```

PRELIMINARY

Freescale Semiconductor, Inc.

APPENDIX B - ADI I/F

The ADI parallel port supplies parallel link from the MPC8XXFADS to various host computers. This port is connected via a 37 line cable to a special board called ADI (Application Development Interface) installed in the host computer. Four versions of the ADI board are available to support connection to IBM-PC/XT/AT, MAC II, VMEbus computers and SUN-4 SPARC stations. It is possible to connect the MPC281ADS board to these computers provided that the appropriate software drivers are installed on them.

Each MPC281ADS can have 8 possible slave addresses set for its ADI port, enabling up to 8 MPC281ADS boards to be connected to the same ADI board.

The ADI port connector is a 37 pin, male, D type connector. The connection between the MPC281ADS and the host computer is by a 37 line flat cable, supplied with the ADI board. [FIGURE A-1](#) below shows the pin configuration of the connector.

FIGURE A-1 ADI Port Connector

Gnd	20	1	N.C.
Gnd	21	2	D_C~
Gnd	22	3	HST_ACK
Gnd	23	4	ADS_SRESET
Gnd	24	5	ADS_HRESET
Gnd	25	6	ADS_SEL2
Gnd	26	7	ADS_SEL1
(+ 12 v) N.C.	27	8	ADS_SEL0
HOST_VCC	28	9	HOST_REQ
HOST_VCC	29	10	ADS_REQ
HOST_VCC	30	11	ADS_ACK
HOST_ENABLE~	31	12	N.C.
Gnd	32	13	N.C.
Gnd	33	14	N.C.
Gnd	34	15	N.C.
PD0	35	16	PD1
PD2	36	17	PD3
PD4	37	18	PD5
PD6		19	PD7

NOTE: Pin 26 on the ADI is connected to +12 v power supply, but it is not used in the MPC281ADS.

B•1 ADI Port Signal Description

The ADI port on the MPC281ADS was slightly modified to generate either hard reset or soft reset. This feature was added to comply with the MPC's reset mechanism.

In the list below, the directions 'I', 'O', and 'I/O' are relative to the MPC8XXFADS board. (I.E. 'I' means input to the MPC8XXFADS)

NOTE:

Since the ADI was originated for the DSP56001ADS some of its signals throughout the boards it was used with, were designated with the prefix "ADS". This convention is kept with this design also.

- ADS_SEL(0:2) - 'I'

These three input lines determine the slave address of the MPC8XXFADS being accessed by the host computer. Up to 8 boards can be addressed by one ADI board.

- ADS_SRESET - 'I'
This input line is used to generate Soft Reset for the MPC. When an ads is selected and this line is asserted by the host computer, Soft Reset will be generated to the MPC along with the Soft Reset configuration applied during that sequence.
- HOST_ENABLE~ - 'I'
This line is always driven low by the ADI board. When an ADI is connected to the MPC8XXFADS, this signals enabled the operation of the debug port controller. Otherwise the debug port controller is disabled and its outputs are tri-stated.
- ADS_HRESET - 'I'
When a host is connected, this line is used in conjunction with the addressing lines to generate a Hard Reset to the MPC8XXFADS board. When this signal is driven in conjunction with the ADS_SRESET signal, the ADI I/F state machines and registers are reset.
- HOST_REQ - 'I'
This signal initiates a host to MPC8XXFADS write cycle.
- ADS_ACK - 'O'
This signal is the MPC8XXFADS response to the HOST_REQ signal, indicating that the board has detected the assertion of HOST_REQ.
- ADS_REQ - 'O'
This signal initiates an MPC8XXFADS to host write cycle.
- HST_ACK - 'I'
This signal serves as the host's response to the ADS_REQ signal.
- HOST_VCC - 'I' (three lines)
These lines are power lines from the host computer. In the MPC8XXFADS, these lines are used by the hardware to determine if the host computer is powered on.
- PD(0:7) - 'I/O'

These eight I/O lines are the parallel data bus. This bus is used to transmit and receive data from the host computer.

APPENDIX C - ADI Installation

C•1 INTRODUCTION

This appendix describes the hardware installation of the ADI board into various host computers.

The installation instructions cover the following host computers:

- 1) IBM-PC/XT/AT
- 2) SUN - 4 (SBus interface)

C•2 IBM-PC/XT/AT to MPC8XXFADS Interface

The ADI board should be installed in one of the IBM-PC/XT/AT motherboard system expansion slots. A single ADI can control up to eight MPC8XXFADS boards. The ADI address in the computer is configured to be at I/O memory addresses 100-102 (hex), but it may be reconfigured for an alternate address space.

CAUTION

BEFORE REMOVING OR INSTALLING ANY EQUIPMENT IN THE IBM-PC/XT/AT COMPUTER, TURN THE POWER OFF AND REMOVE THE POWER CORD.

C•2•1 ADI Installation in IBM-PC/XT/AT

Refer to the appropriate Installation and Setup manual of the IBM-PC/XT/AT computer for instructions on removing the computer cover.

The ADI board address block should be configured at a free I/O address space in the computer. The address must be unique and it must not fall within the address range of another card installed in the computer.

The ADI board address block can be configured to start at one of the three following addresses:

- \$100 - This address is unassigned in the IBM-PC
- \$200 - This address is usually used for the game port
- \$300 - This address is defined as a prototype port

The ADI board is factory configured for address decoding at 100-102 hex in the IBM-PC/XT/AT I/O address map. These are undefined peripheral addresses.

FIGURE A-1 Physical Location of jumper JG1 and JG2



NOTE: Jumper JG2 should be left unconnected.

The following figure shows the required jumper connection for each address configuration. Address 0 hex is not recommended, and its usage might cause problems.

FIGURE A-2 JG1 Configuration Options



To properly install the ADI board, position its front bottom corner in the plastic card guide channel at the front of the IBM-PC/XT/AT chassis. Keeping the top of the ADI board level and any ribbon cables out of the way, lower the board until its connectors are aligned with the computer expansion slot connectors. Using evenly distributed pressure, press the ADI board straight down until it seats in the expansion slot.

Secure the ADI board to the computer chassis using the bracket retaining screw. Refer to the computer Installation and Setup manual for instructions on reinstalling the computer cover.

C•3 SUN-4 to MPC8XXFADS Interface

The ADI board should be installed in one of the SBus expansion slots in the Sun-4 SPARCstation computer. A single ADI can control up to eight MPC8XXFADS boards.

CAUTION

BEFORE REMOVING OR INSTALLING ANY EQUIPMENT IN THE SUN-4 COMPUTER, TURN THE POWER OFF AND REMOVE THE POWER CORD.

C•3•1 ADI Installation in the SUN-4

There are no jumper options on the ADI board for the Sun-4 computer. The ADI board can be inserted into any available SBus expansion slot on the motherboard.

Refer to the appropriate Installation and Setup manual for the Sun-4 computer for instructions on removing the computer cover and installing the board in an expansion slot.

FIGURE A-3 ADI board for SBus



Following is a summary of the Instructions in the Sun manual:

1. Turn off power to the system, but keep the power cord plugged in. Be sure to save all open files and then the following steps should shut down your system:
 - hostname% /bin/su
 - Password: mypasswd
 - hostname# /usr/etc/halt
 - wait for the following messages.

```
Syncing file systems... done
Halted
Program Terminated
Type b(boot), c(continue), n(new command mode)
```
 - When these messages appear, you can safely turn off the power to the system unit.
2. Open the system unit. Be sure to attach a grounding strap to your wrist and to the metal casing of the power supply. Follow the instructions supplied with your system to gain access to the SBus slots.
3. Remove the SBus slot filler panel for the desired slot from the inner surface of the back panel of the system unit. Note that the ADI board is a slave only board and thus will function in any available SBus slot.
4. Slide the ADI board at an angle into the back panel of the system unit. Make sure that the mounting plate on the ADI board hooks into the holes on the back panel of the system unit.

5. Push the ADI board against the back panel and align the connector with its mate and gently press the corners of the board to seat the connector firmly.
6. Close the system unit.
7. Connect the 37 pin interface flat cable to the ADI board and secure.
8. Turn power on to the system unit and check for proper operation.

PRELIMINARY

Freescale Semiconductor, Inc.



MOTOROLA INC.	
PROJECT : MPC8XXFADS	REV : ENG
ENG : YAIR LIEBMAN	BLOCK : SDRAM
CHK :	DESCRIP :
SHEET 1 OF 14	

For More Information On This Product, Go to: www.freescale.com

Freescale Semiconductor, Inc.

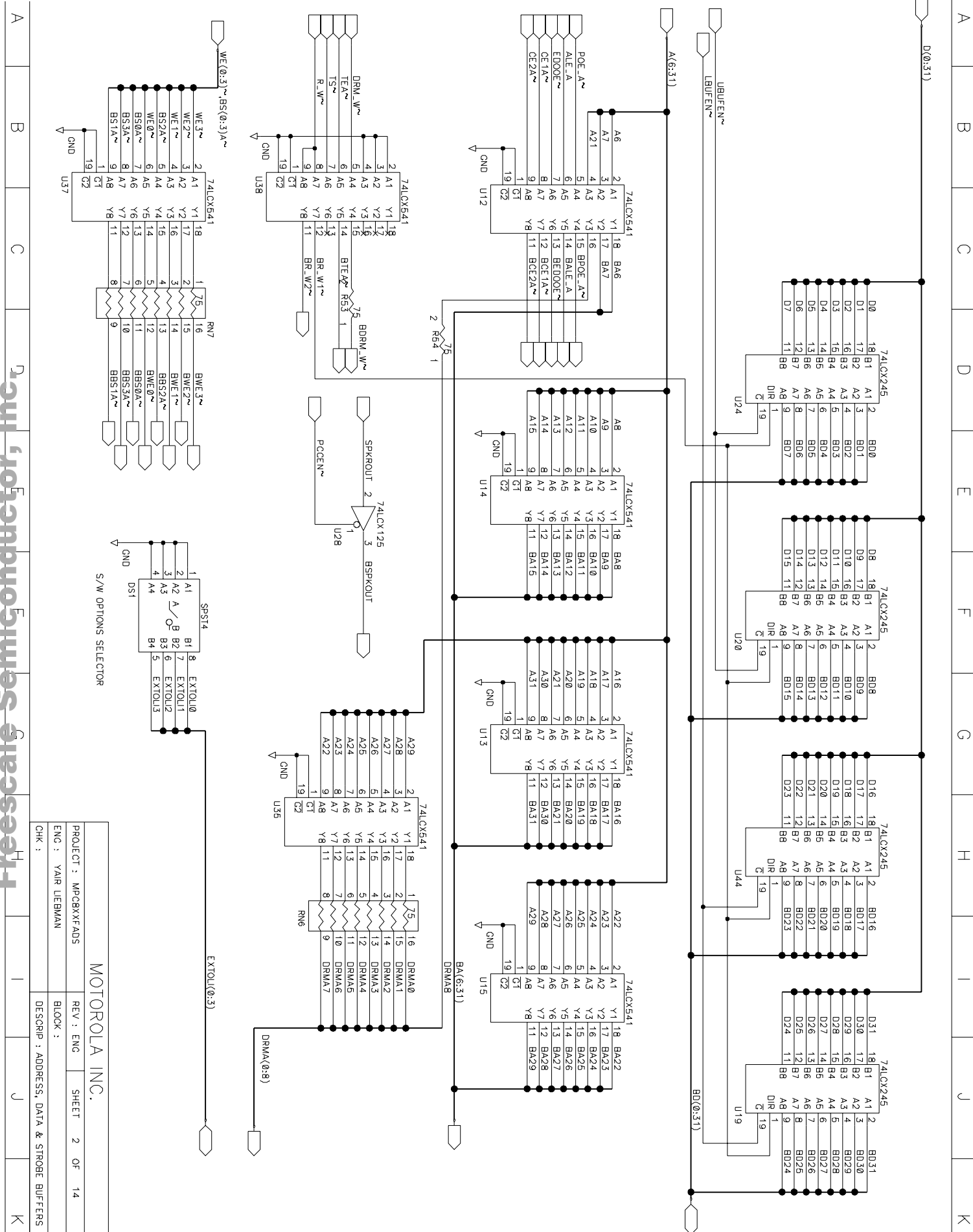

MOTOROLA INC.

PROJECT :	MPC8XXFADS	SHEET	2 OF 14
REV :	ENG	BLOCK :	
ENG :	YAIR LIEBMAN	DESCRIP :	ADDRESS, DATA & STROBE BUFFERS
CHK :			

For More Information On This Product, Go to: www.freescale.com

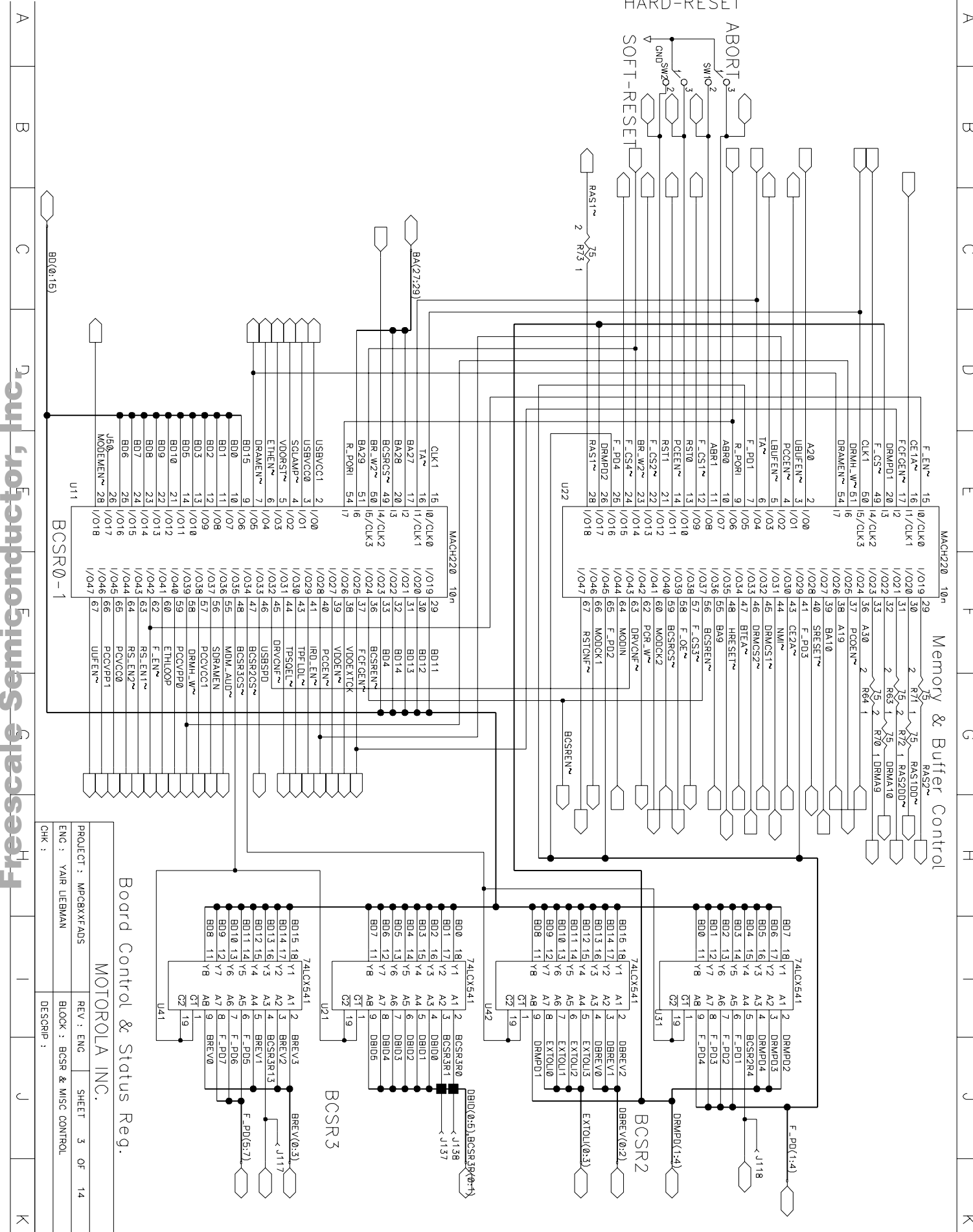



Freescale Semiconductor, Inc.

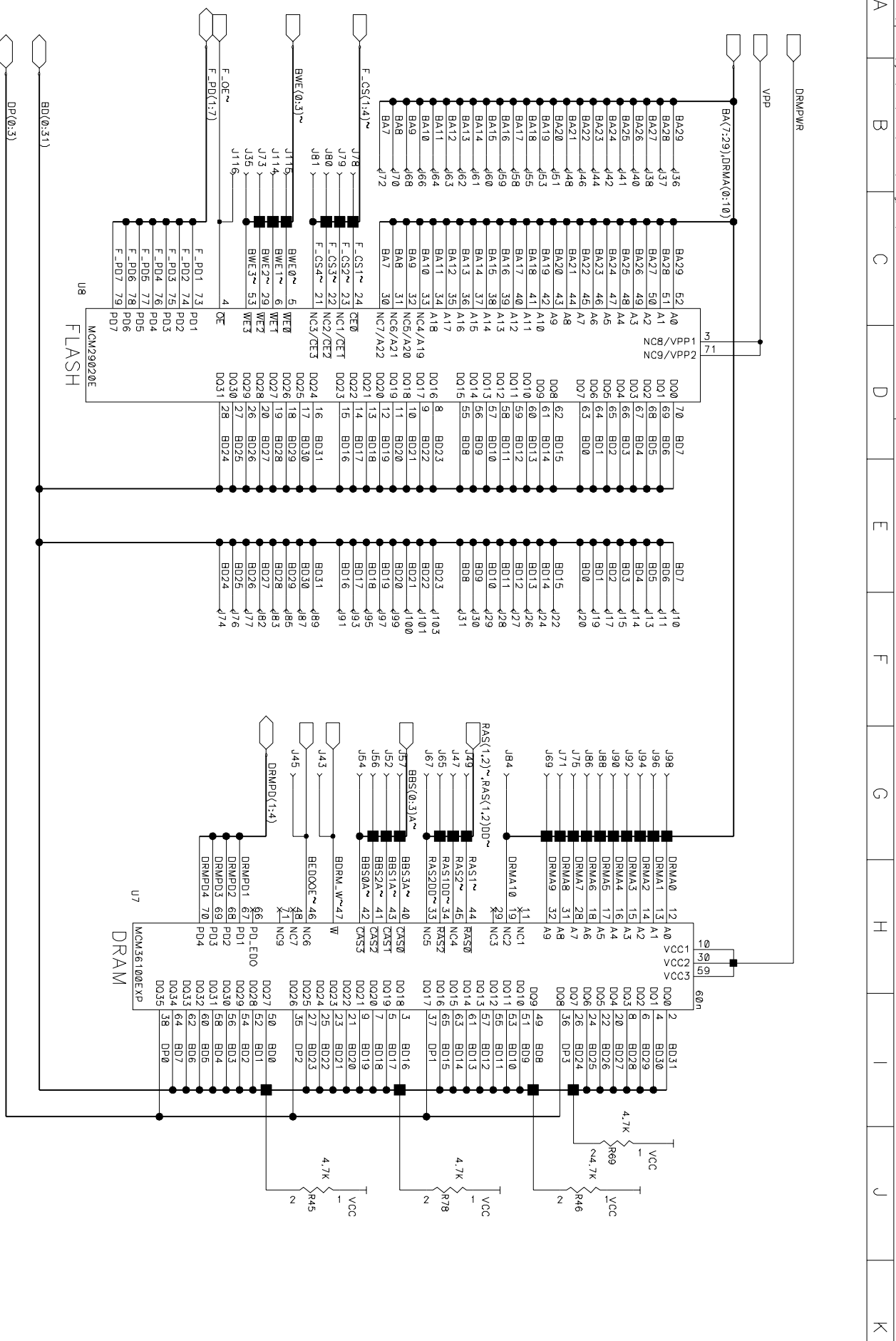

A	B	C	D	E	F	G	H	I	J	K
<p>MOTOROLA INC.</p> <p>PROJECT : MPCRXXFADS REV : ENG SHEET 4 OF 14</p> <p>ENG : YAIR LIEBMAN BLOCK : DRAM & FLASH MODULES</p> <p>CHK :</p> <p>DESCRIP :</p>										

For More Information On This Product, Go to: www.freescale.com

Freescale Semiconductor, Inc.

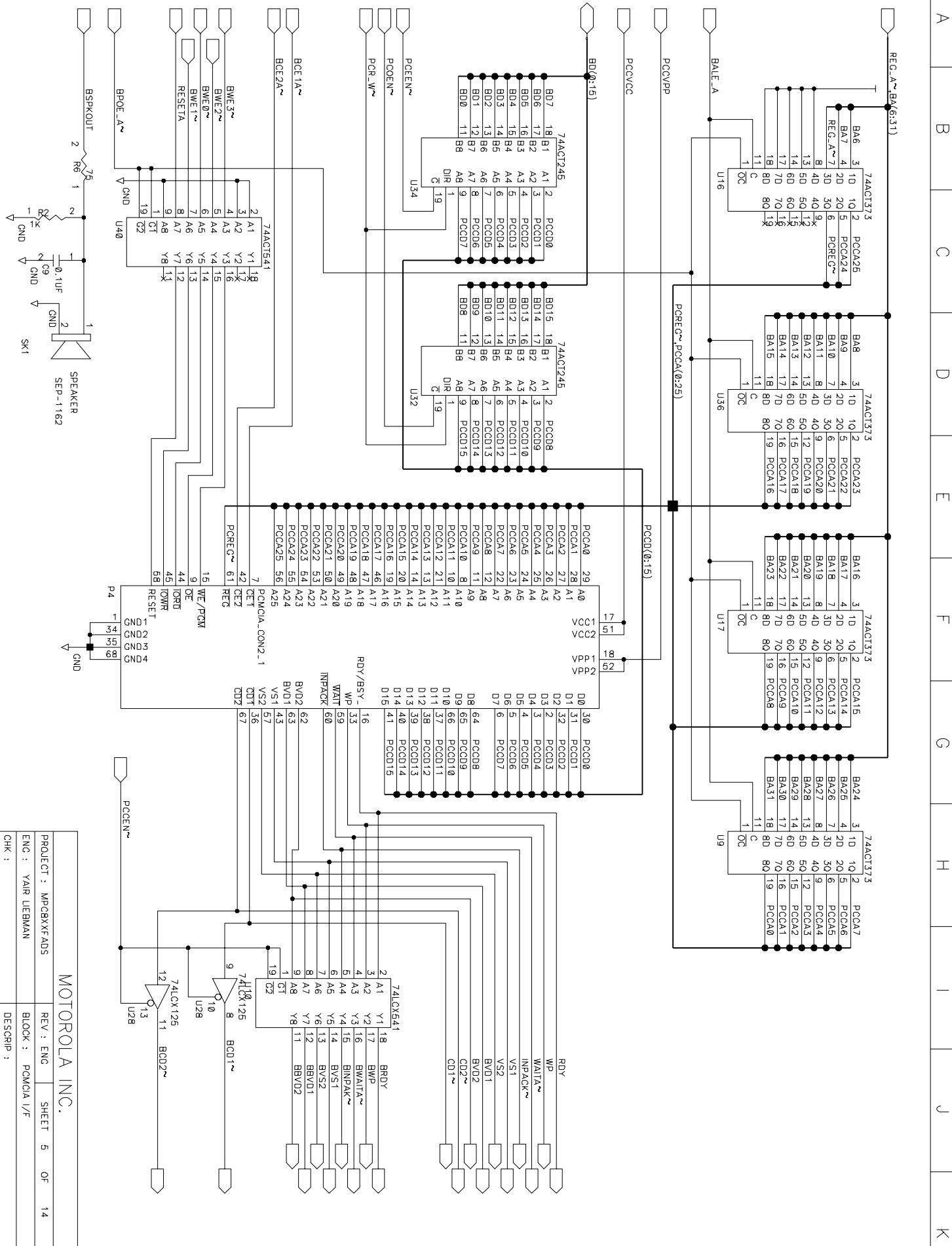

A B C D E F G H I J K

PROJECT :	MPC8XXFADS	SHEET	5	OF	14
ENG :	YAIR LIEBMAN	BLOCK :	PCMICA I/F	DESCRIP :	
CHK :					

MOTOROLA INC.

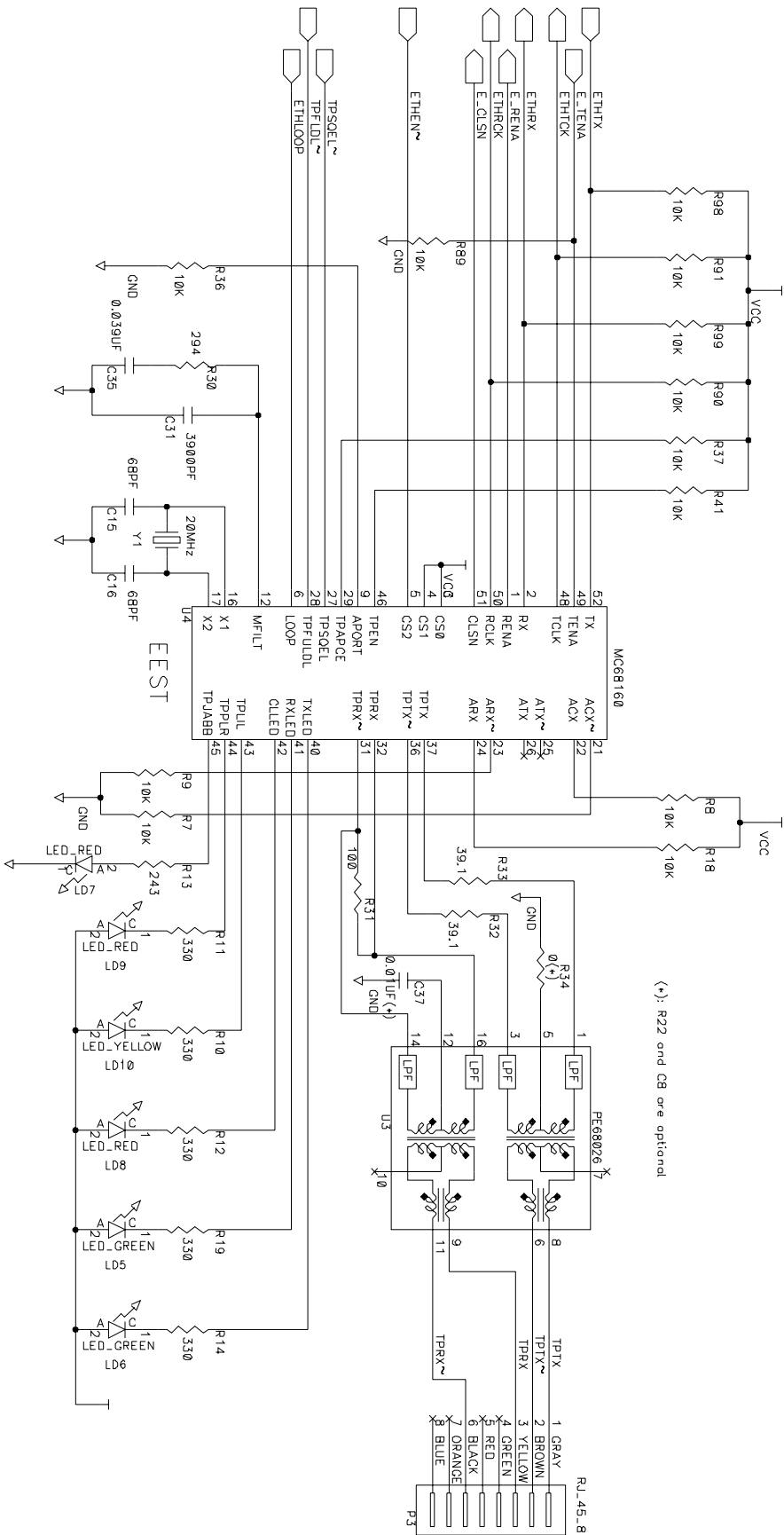

MOTOROLA INC.

PROJECT :	MPGBXXFA05	SHEET	6	OF	1
ENG :	YAIR LIEBMAN	BLOCK :	T.P. ETHERNET PORT		
CHK :		DESCRIP :			

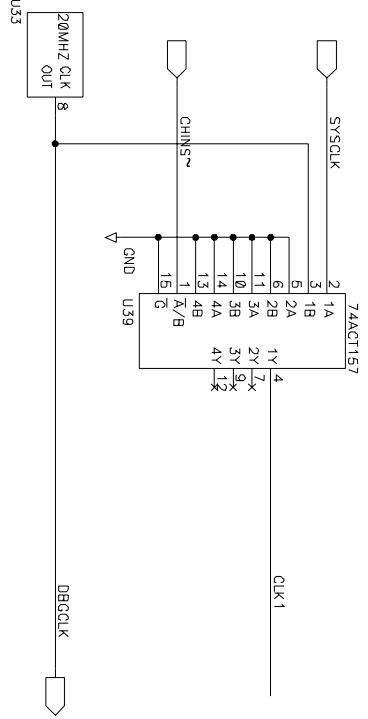
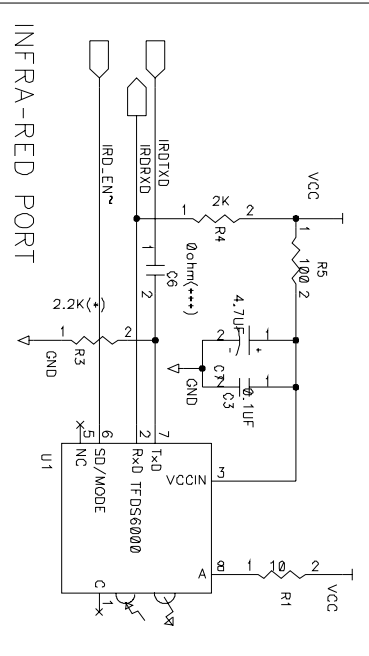
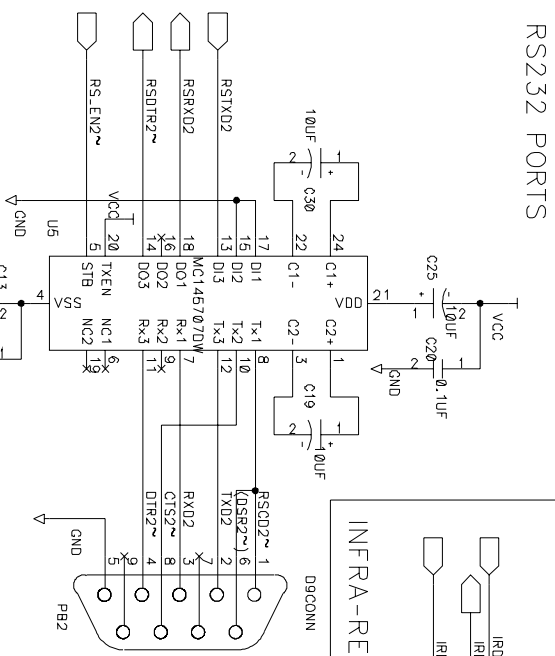
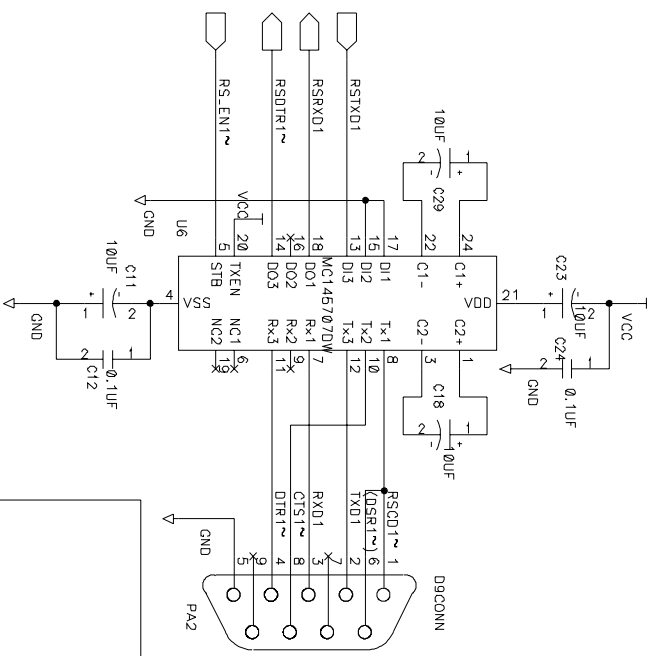

(+): R6 SHOULD NOT BE ASSEMBLED
 (***): C7 IS SHORTED WITH 0ohm RESISTOR

MOTOROLA INC.			
PROJECT :	MPC8XXFADS	REV :	ENG
ENG :	YAIR LIEBMAN	BLOCK :	RS232, Infra Red & Clock Generator
CHK :		DESCRIP :	
SHEET 7 OF 14			

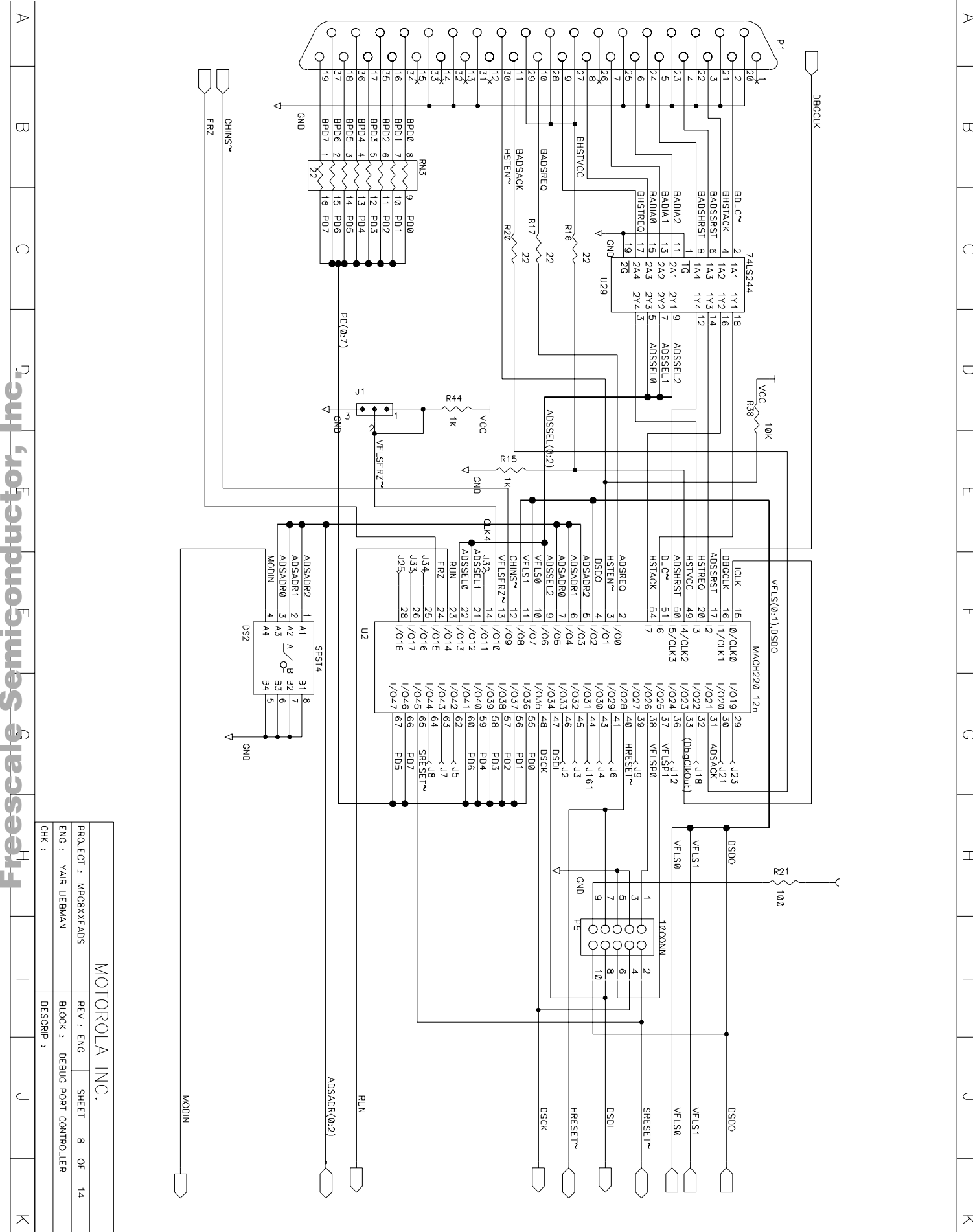

MOTOROLA INC.

PROJECT :	MPC8XXFADS	REV :	ENG	SHEET	8	OF	14
ENG :	YAIR LIEBMAN	BLOCK :	DEBUG PORT CONTROLLER	DESCRIP :			
CHK :							

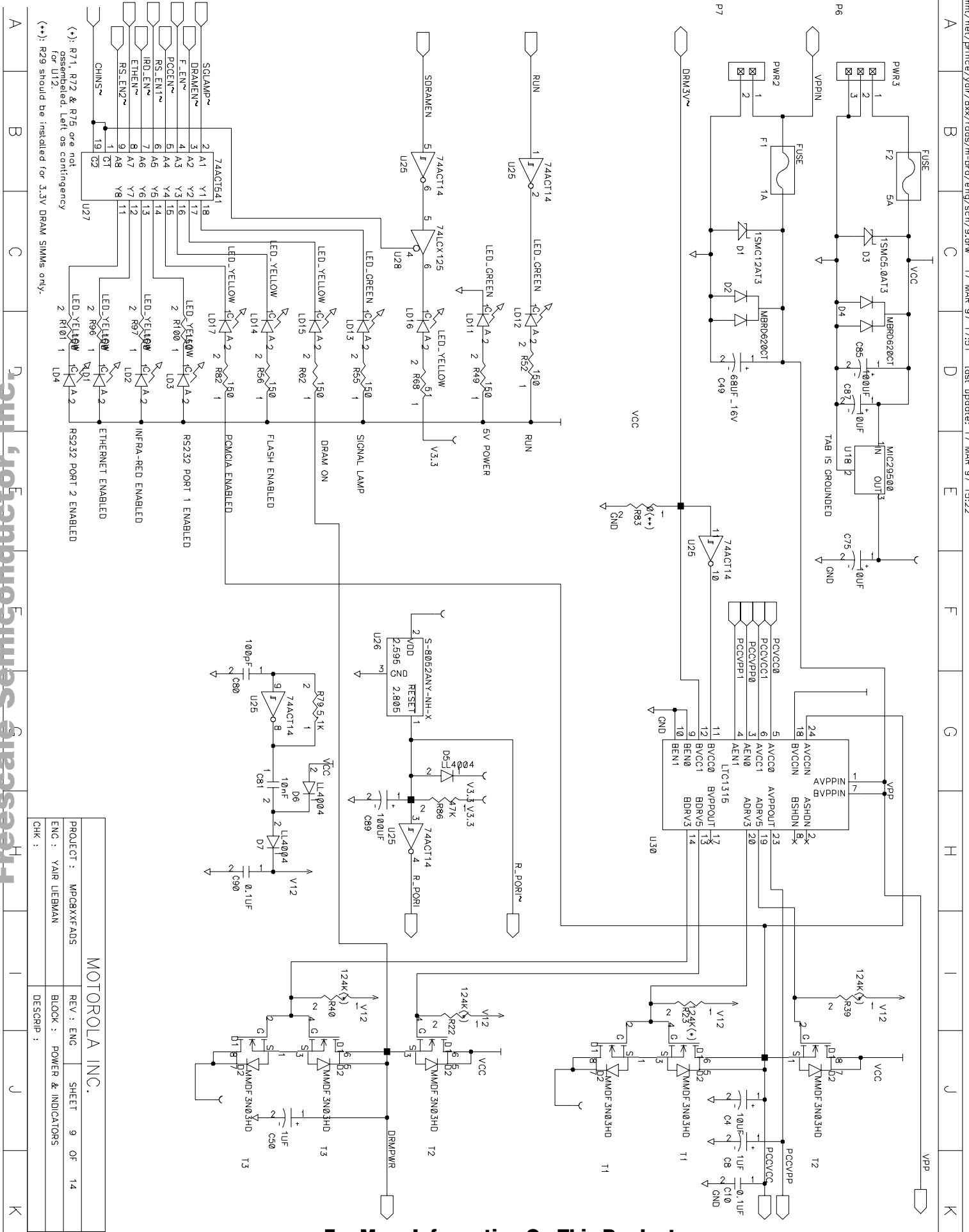

For More Information On This Product,
Go to: www.freescale.com



PROJECT :	MP68XXFA05	SHEET	9	OF	14
ENG :	YAIR LIEBMAN	BLOCK :	POWER & INDICATORS		
CHK :		DESCRIP :			

MOTOROLA INC.

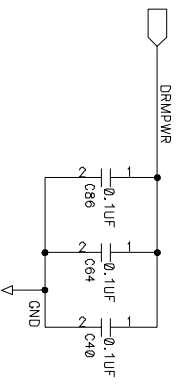

MOTOROLA INC.	
PROJECT : MPRBXXFADS	SHEET 10 OF 14
ENG : YAIR LEBMAN	BLOCK : DECOUPLING CAPS.
CHK :	DESCRIP :



Freescale Semiconductor, Inc.



Freescale Semiconductor, Inc.

PULL-DOWNS

SPARE PARTS

MOTOROLA INC.

PROJECT :	MPC8XXFADS	REV :	ENG	SHEET	11	OF	14
ENG :	YAIR LIEBMAN	BLOCK :	PULL-UP / DOWN RESISTORS				
CHK :	DESCRIP :						

Freescale Semiconductor, Inc.

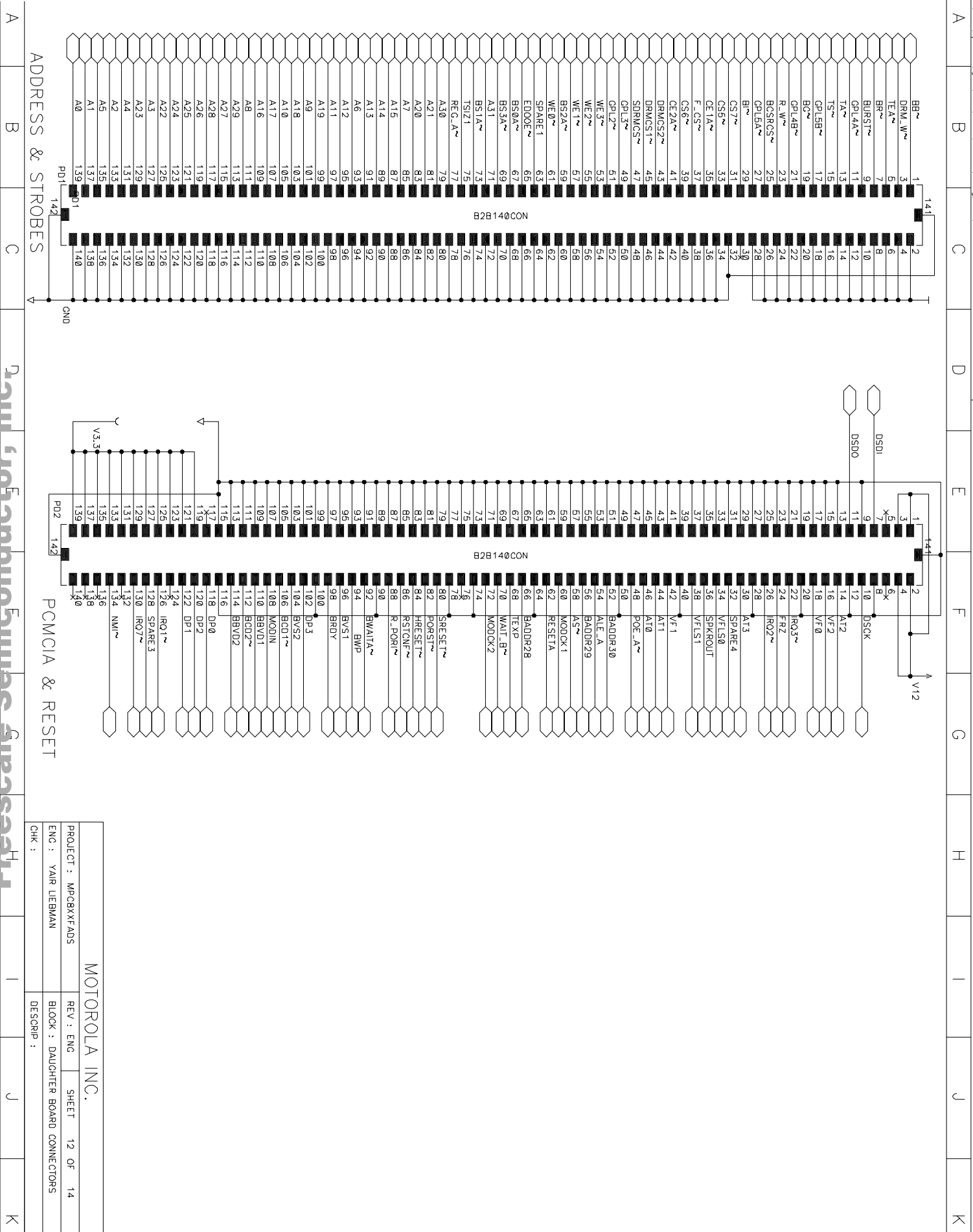

Freescale Semiconductor, Inc.

MOTOROLA INC.			
PROJECT :	MPC8XXFADS	REV :	ENG
ENG :	YAIR LIEBMAN	BLOCK :	DAUGHTER BOARD CONNECTORS
CHK :		DESCRIP :	

Freescale Semiconductor, Inc.

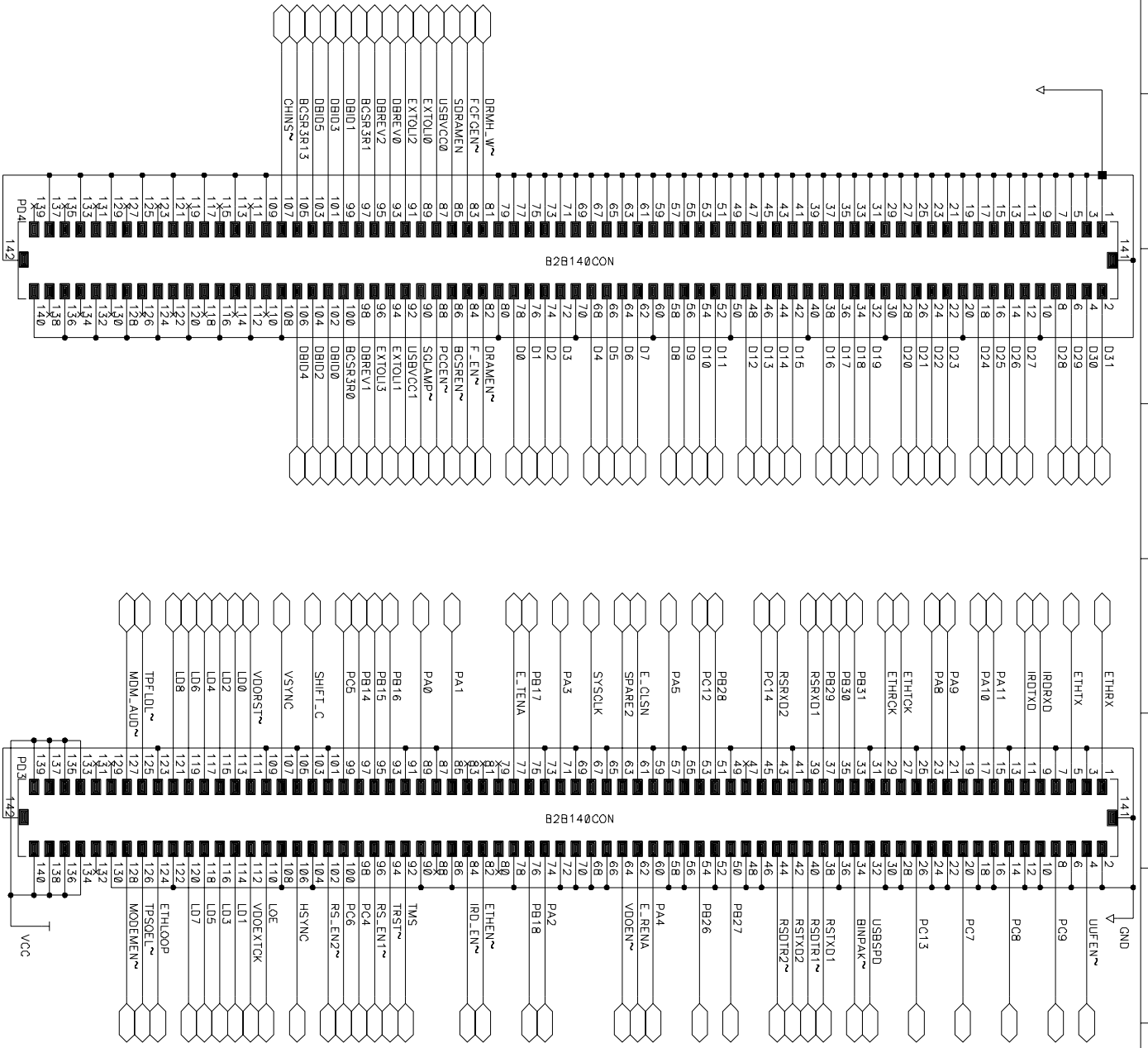

Freescale Semiconductor, Inc.

MOTOROLA INC.			
PROJECT :	MPC8XXFADS	SHEET	13 OF 14
ENG :	YAIR LIEBMAN	BLOCK :	DAUGHTER BOARD CONNECTOR
CHK :		DESCRIP :	



QUADS COMPATIBLE EXPANSION CONNECTOR



A	B	C	D	E	F	G	H	I	J	K
---	---	---	---	---	---	---	---	---	---	---

MOTOROLA INC.			
PROJECT :	MPC8XXFADS	SHEET	14 OF 14
ENG :	YAIR LIEBMAN	BLOCK :	QUADS COMPATIBLE EXPANSION CONN.
CHK :		DESCRIP :	

MPC860TFADS Daughter Board Design Specification—Rev 0.1

PRELIMINARY





Motorola reserves the right to make changes without further notice to any products herein. Motorola makes no warranty, representation or guarantee regarding the suitability of its products for any particular purpose, nor does Motorola assume any liability arising out of the application or use of any product or circuit, and specifically disclaims any and all liability, including without limitation consequential or incidental damages. "Typical" parameters can and do vary in different applications. All operating parameters, including "Typicals" must be validated for each customer application by customer's technical experts. Motorola does not convey any license under its patent rights nor the rights of others. Motorola products are not designed, intended, or authorized for use as components in systems intended for surgical implant into the body, or other applications intended to support or sustain life, or for any other application in which the failure of the Motorola product could create a situation where personal injury or death may occur. Should Buyer purchase or use Motorola products for any such unintended or unauthorized application, Buyer shall indemnify and hold Motorola and its officers, employees, subsidiaries, affiliates, and distributors harmless against all claims, costs, damages, and expenses, and reasonable attorney fees arising out of, directly or indirectly, any claim of personal injury or death associated with such unintended or unauthorized use, even if such claim alleges that Motorola was negligent regarding the design or manufacture of the part.

Motorola and  are registered trademarks of Motorola, Inc. Mfax is a trademark of Motorola, Inc. Motorola, Inc. is an Equal Opportunity/Affirmative Action Employer.

**For More Information On This Product,
Go to: www.freescale.com**

1 - General Information

1•1 Introduction

This document is the operation guide for the MPC8XXFADS Daughter Board for the MPC860T-named the MPC860TFADSDB.

The daughter board holds the evaluated MPC860T along with some necessary logic, which is required to be in the nearest vicinity of the MPC860T as well as peripherals, that are dedicated to the MPC860T and are not required for any other member of the MPC8XX family.

The daughter board has 2 sets of matching connectors - on the print^A side and on the component^B side. Those on the print side, connect to a matching set found on the MPC8XXFADS while those on the component side, are to serve hardware expansion via a dedicated adaptor.

In addition, a set of logic analyzer connector is featured matching the new high density HP16500 logic analyzer adaptors, this to provide fast connection to logic analyzer while saving on board's space and reducing EMI.

1•2 Abbreviations' List

- FADS^C - the MPC8XXFADS, to which this board connects.
- UPM - User Programmable Machine
- GPCM - General Purpose Chip-select Machine
- GPL - General Purpose Line (associated with the UPM)
- DB - Daughter Board the MPC860TFADSDB, the subject of this document.
- MPC860T - MPC860 + Fast Ethernet Controller.
- BSCR - Board Control & Status Register.
- ZIF - Zero Input Force
- BGA - Ball Grid Array
- Spec - engineering Specification Document.

1•3 Related Documentation

- MPC860T User's Manual.
- ADI Board Specification.
- MPC8XXFADS Engineering Specification
- Level One's LXT970 Data Sheet. May be obtained from <http://www.level1/ds/970.html>

A. Board's bottom.

B. Board's top.

C. Not to be mistaken for the M683XX Family Ads

1•4 SPECIFICATIONS

The MPC860TFADSDB specifications are given in [TABLE 1-1](#).

TABLE 1-1. 860TFADSDB Specifications

CHARACTERISTICS	SPECIFICATIONS
Microprocessor	MPC860T @ 50 MHz
Operating temperature	0°C - 30°C
Storage temperature	-25°C to 85°C
Relative humidity	5% to 90% (non-condensing)
Dimensions:	
Length	5.87" (149 mm)
Width	4.37" (111 mm)
Thickness	0.063" (1.6 mm)

1•5 MPC860T-FADSDB Features

- MPC860T running upto 50 MHz
- On-Board Fast Ethernet Level One LXT970, with shutdown option over Twisted pair (Ethernet 100Base TX).
- 5 Dip Switches for the LXT970 power up configuration.
- Option, for Fast Ethernet over Fiber Optics (Ethernet 100Base FX).
- Selectable KAPWR source: 3.3V or externally supplied
- Selectable VDDL source: 3.3V or 2V
- Selectable clock source: 32768Hz crystal resonator or 4^A MHz Clock generator.
- On-Board Expansion connectors, including all MPC pins and MPC8XXFADS control / status signals.
- On-Board High Density Logic Analyzer connectors, supporting fast connection to HP 16500 logic analyzer (AMP Mictor).

A. May be easily changed to any 3.3V powered oscillator oscillating in 3 - 5 MHz frequency range.

FIGURE 1-1 MPC860T-FADSDB Block Diagram



Freescale Semiconductor, Inc.

PRELIMINARY

2 - Hardware Preparation and Installation

2•1 INTRODUCTION

This chapter provides unpacking instructions, hardware preparation, and installation instructions for the MPC860TFADSDB.

2•2 UNPACKING INSTRUCTIONS

NOTE

If the shipping carton is damaged upon receipt, request carrier's agent to be present during unpacking and inspection of equipment.

Unpack equipment from shipping carton. Refer to packing list and verify that all items are present. Save packing material for storing and reshipping of equipment.

CAUTION

AVOID TOUCHING AREAS OF INTEGRATED CIRCUITRY; STATIC DISCHARGE CAN DAMAGE CIRCUITS.

2•3 HARDWARE PREPARATION

To select the desired configuration and ensure proper operation of the MPC860TFADSDB board, changes of the jumpers settings may be required before installation. The location of the switches, LEDs, and connectors is illustrated in [FIGURE 2-1 "MPC860TFADSDB Top Side Part Location diagram" on page 5](#). The board has been factory tested and is shipped with Dip-Switch settings as described in the following paragraphs. Parameters can be changed for the following conditions:

- Clock generator.
- Power-On Reset Source.
- MPC Keep Alive Power Source
- MPC Internal Logic Supply Source
- LXT970 power up configuration.

FIGURE 2-1 MPC860TFADSDB Top Side Part Location diagram



2•3•1 Clock Generator Replacement - U1

When replacing U1 with another clock generator it should be noticed that there are 2 supply level available at U1:

- 1) 5V supply at pin 14.
- 2) 3.3V supply available at pin 11.

FIGURE 2-2 U1 Power Sources



From looking at [FIGURE 2-2 "U1 Power Sources"](#) above, we see that 5V (with 3.3V output only!) oscillator may be used with 14 pins only form-factor while 3.3V oscillators may be used with 8 pins only form-factor.

WARNING

IF A 14 Pin Form-Factor, 3.3V Clock Generator is inserted to U1, PERMANENT DAMAGE Might Be Inflicted To The Device.

WARNING

Since the MPC clock input is NOT 5V TOLERANT, any clock generator inserted to U1, MUST HAVE 3.3V compatible output. If a 5V output clock generator is inserted to U1, PERMANENT DAMAGE might be inflicted to the MPC.

2•3•2 Power-On Reset Source Selection

As there are differences between MPC revisions regarding the functionality of the Power-On Reset logic, it is therefore necessary to select different sources for Power-ON reset generation.

J1 on the MPC860TFADSDB is used to select Power-On Reset source: when a jumper is placed between positions 1 - 2 of J1, Power-On reset to the MPC is generated by the Keep-Alive power rail. I.e., When KAPWR goes below 2.005V - Power-On reset is generated. When a jumper is placed between position 2 - 3 of J1, Power-On reset to the MPC is generated from the MAIN 3.3V power rail. I.e., when the MAIN 3.3V power rail goes below 2.805V Power-On reset is generated.

FIGURE 2-3 Power-On Reset Source Selection



2•3•3 VDDL Source Selection

J3 serves as a selector for VDDL - MPC internal logic supply. When a jumper is placed between positions 1 - 2 of J3, VDDL is supplied with 3.3V. When a jumper is placed between positions 2 - 3 of J3, VDDL is supplied by 2V power source. The jumper on J3 is factory set between positions 1 - 2 to supply 3.3 to VDDL.

FIGURE 2-4 VDDL Source Selection

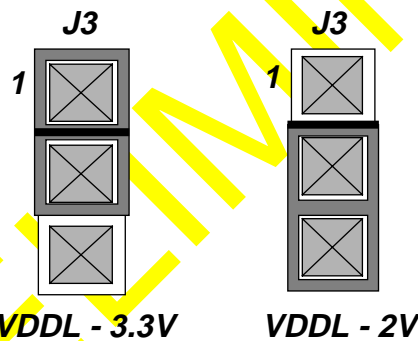

2•3•4 Keep Alive Power Source Selection

J2 selects the Keep Alive power source of the MPC. When a jumper is placed between positions 1 - 2 of J2, the Keep Alive power is fed from the main 3.3V bus. When an external power source^A is to be connected to the Keep Alive power rail, it should be connected between positions 2 (the positive pole) and position 3 (GND) of J2.

^A. E.g., a battery.

FIGURE 2-5 Keep Alive Power Source Selection



2•3•5 LXT970 Power Up HW Configuration

The LXT970 can be configured for power up by 9 pins 5 of them are connected to the LXT970 through DS1 (DS1 is a 16 pin contain 8 dip switches) they are the HW configuration pins. The pins MF0 - MF4 can configure the following options:

- MF0 enables the autonegotiation, if DS1(1) is OFF it enable the autonegotiation
- MF1 selects DTE or Repeater, if DS1(2) is ON it enable the DTE mode.
- MF2 selects symbol (5B) or Nibble (4B) if DS1(3) is ON Nibble (4B) is selected.
- MF3 enables scrambler operation, if DS1(4) is ON the scrambler operation is enabled.
- MF4 select the output possibility options, twisted pair or the fiber optic.



DS1 Default Configuration.

2•4 INSTALLATION INSTRUCTIONS

The MPC860TFADSDB should be plugged into the MPC8XXFADS Mother Board. This should be done when the FADS is disconnected from any power supply. The 860TDB should be placed over the mother board connectors in a way that the mother board connectors of the 860TDB, PM1 - PM4 match the daughter connectors of the FADS and than pressed gently into position.

The connectors are arranged in a non symmetrical form, so miss-insertion is inhibited.

3 - OPERATING INSTRUCTIONS

3•1 INTRODUCTION

This chapter provides necessary information to use the MPC860TFADSDB

3•2 CONTROLS AND INDICATORS

The MPC860TFADSDB has in addition to the switches a few indicators - described below..

3•2•1 GND Bridges

There are 4 GND bridges on the MPC860TFADSDB. They are meant to assist general measurements and logic-analyzer connection.

Warning

The GND bridges on board, physically resemble J4. Do not mistake J4 to be a GND jumper, otherwise, permanent damage might be inflicted to the MPC860TFADSDB and or to the MPC8XXFADS.

Warning

When connecting to a GND bridge, use only INSULATED GND clips. Failure in doing so, might result in permanent damage to the MPC860TFADSDB.

3•2•2 3.3V Indicator - LD1

The yellow 3.3V led LD1 indicates that the 3.3V power bus is powered from the MPC8XXFADS.

3•2•3 Receive Led - LD2

When the yellow LD4 is light, the fast ethernet receive is in process, for 10M or for 100M.

3•2•4 Transmit Led - LD3

When the yellow LD5 is light, the fast ethernet transmit is in process, for 10M or for 100M.

3•2•5 Link Led - LD4

When the yellow LD6 is light, during the 100Mbps operation indicates scrambler lock and receipt of valid idle codes. During 10Mbps operation, indicates link valid status.

3•2•6 Collision Led - LD5

When the yellow LD7 is light, in the default mode it indicates a collision. However this led is a programmable led and it can indicate other definitions. For a programming options see configuration register, register 19 in the LXT970 user guide.

3•2•7 Speed Led- LD6

When the Speed Led is light it indicates that the LXT970 operate in 100Mbps. When this led is off and the led on indication is on so the ethernet speed is 10M. Note the 10M ethernet means 10M operating through the MII bus.

3•2•8 Fast - Ethernet - On Indicator - LD7

When the yellow Fast - Ethernet-ON indicator led LD2 is lit, it designates that the LXT970 transceiver is enabled for the Fast - Ethernet operation. When it is darkened, the LXT970 is tri-stated and the MII pins output from the LXT970 are in three-state. these pins with the input to the LXT970 pins may be used for any alternate function. See also [TABLE 4-23. "BCSR4 Description" on page 57](#) of the MPC8XXFADS User's Manual.

3•3 MEMORY MAP

The memory map is identical to all daughter boards, therefore described in the MPC8XXFADS User's Manual - section 3•3 "MEMORY MAP" on page 16.

3•4 MPC Registers' Programming

See 3•4 "MPC Registers' Programming" on page 10 of the MPC8XXFADS User's Manual.

PRELIMINARY

4 - Functional Description

In this chapter the various modules combining the MPC860TFADSDB are described to their design details.

4•1 Reset & Reset - Configuration

There are 3 reset sources for the MPC:

- 1) Power-On Reset^A
- 2) Hard Reset
- 3) Soft Reset

4•1•1 Power-On Reset

The Power - On Reset on the MPC860T-FADSDB is generated out of 2 alternative power buses:

- 1) The keep alive power bus
- 2) The MAIN power bus.

Selection between the 2 options is done by means of jumper.

When option (1) above is selected, the power-on reset is generated by a dedicated voltage detector made by Seiko the S-8051HN-CD-X with detection voltage range of 1.795 to 2.005V. During keep alive power-on or when there is a voltage drop of that input into the above range Power-On Reset is generated, i.e., PORESET* input of the MPC is asserted for a period of approximately 4 sec.

When option (2) above is selected, the power-on reset is generated by a dedicated voltage detector made

by Seiko the S-8052ANY-NH-X with detection voltage range of 2.595V to 2.805V. During MAIN 3.3V bus power-on or when there is a voltage drop of that input into the above range Power-On Reset is generated, i.e., PORESET* input of the MPC is asserted for a period of approximately 4 sec. The MAIN power on reset also generates power-on reset to all logic located on the motherboard.

When PORESET* is asserted to the MPC, the Power-On reset configuration is made available to MPC. See [4•1•6•1 "Power - On Reset Configuration" on page 29](#) of MPC8XXFADS User's Manual.

4•1•2 Hard Reset

Hard Reset is generated to the MPC860T by the following sources:

- 1) The MAIN power-on reset
- 2) Manual Hard Reset generated on the mother board
- 3) The debug port Hard reset
- 4) and by MPC860T's internal sources.

When the open-drain signal Hard Reset is asserted, Hard reset configuration is driven on the data bus by logic on the motherboard. See [4•1•6•2 "Hard Reset Configuration" on page 29](#) on MPC8XXFADS User's Manual.

4•1•3 Soft Reset

Soft Reset is generated to the MPC860T by the following sources:

- 1) The debug port controller located on the motherboard
- 2) Manual Soft Reset generated on the motherboard

A. In fact generated on the daughter board.

3) and by MPC860T internal sources.

When Soft reset is generated to the MPC860T, Soft Reset configuration is made available to the MPC by logic residing over the motherboard. See [4•1•6•3 "Soft Reset Configuration" on page 29](#) on MPC8XXFADS User's Manual.

4•2 Interrupts

Two external interrupts are applied to the MPC via its interrupt controller the ABORT (NMI), which is generated by a push-button & logic residing over the motherboard, and the other on is the IRQ2 which is the interrupt of the LXT970 Fast Ethernet Transceiver.

4•3 Clock Generator

Although most of clock generator logic is found on this board, it is documented within the motherboard User's Manual, since, it is common to all daughter boards. See [4•3 "Clock Generator" on page 30](#) of the MPC8XXFADS User's Manual.

4•4 Fast Ethernet Support

The 860TDB has on-board full support for 802.3 Media Independent Interface (MII), made by the Level One LXT970 device, the connection between the LXT970 and the line can be made by twisted pair RJ45 connector or by fiber optic connector which is an optional only.

The LXT970 used in the 860TDB has the following features: it is a IEEE 802.3 Compatible which is a 10BASE-T and 100BASE-TX using a single RJ45 connector. It support an auto-negotiation via Fast Link Pulse (FLP) exchange and parallel detection for legacy 10BASE-T and 100BASE-TX systems. MII interface, 100BASE-FX fiber optic capable, configurable through the MII serial port, it can be DTE repeater or switch application.

The LXT970 has several control pins that can configure the mode of operation these pins are separated to two pins groups the WH control pins and the SW control pins, the HW control pins are the MF(0:4) connected to the DS1, the SW control pins are the TRSTE, FDE and CFG(0:1) which are controlled via the BCSR4 register.

The following tables illustrate the LXT970 configuration options.

TABLE 4-1. MF0 - MF4 Function Description Pins

PIN NAME	FUNCTION	DS1 ON CONDITION	DS1 OFF CONDITION	Default
MF0	Auto-negotiation	Disable	Enable	Enable
MF1	Repeater/DTE mode	DTE	Repeater	DTE
MF2	Nibble 4B/Symbol 5B	Nibble 4B	Symbol 5B	Nibble 4B
MF3	Scrambler Operation	Enable	Disable	Enable
MF4	Select TX or FX	100TX	100FX	100TX

The following table describe the SW control pins controlled via the BCSR4 register which is on the motherboard

TABLE 4-2. BCSR4 The control pins for the LXT970

<i>BIT</i>	<i>MNEMONIC</i>	<i>FUNCTION</i>	<i>PON DEF</i>	<i>ATT.</i>
4	UUFEN~	When this signal is active (LOW) it enable the LXT970 device. This signal connected to the TRSTE signal of the LXT970. In DTE mode when this pin is high the LXT970 isolate it self from the MII data interface. In repeater mode when it is high the LXT970 tree state the MII output pins.	1	R,W
5	FETHCFG0	Fast Ethernet CFG0 signal When the LXT970 is in auto negotiation a low to high transition in this pin cause an auto negotiate to re-start. When auto negotiation is disabled this input selects operating speed bit 0.13 When this pin is high the 100Mbps is selected 0.13 = 1. When this pin is low the 10Mbps is selected 0.13 = 0.	1	R,W
6	FETHFDE	Full Duplex Enable when auto negotiation is enable the FDE pin of the LXT970 determine full duplex advertisement capability in combination with MF4 and CFG1. See the LXT970 documentation. When auto negotiation is disable the FDE pin of the LXT970 effects full duplex and determines the value of bit 0.8 Duplex Mode. When this pin is high Full Duplex in Enable, 0.8 = 1. When this pin is low Full Duplex is Disable 0.8 = 0.	1	R,W
9	FETHCFG1	Fast Ethernet CFG1 signal When the LXT970 is in auto negotiation this pin determines operating speed advertisement capability in combination with MF4. see See the LXT970 documentation. When auto negotiation is disabled this input enables 10Mbps link test function and directly affects bit 19.8. When this pin is high, 10Mbps link test is disabled 19.8 = 1. When this pin is low, 10Mbps link test is enabled 19.8 = 0.	1	R,W
10	FETHRST~	Fast Ethernet Reset. When this pin active (LOW) signal is being asserted the Fast ethernet tranceiver is being reset.	1	R,W

The Fast Ethernet transceiver support two physical interfaces:

- RJ45 8pin connector for the twisted pair use this connector is mounted on the board.
- Fiber Optic multi mode tranceiver not mounted on the board, it is an optional. The board design for the HP HFBR-5103 or HFBR-5105.

4•5 Board Control & Status Register - BCSR

Most BCSR control signals and some of BCSR's status signals are available on the motherboard connectors and on the expansion connectors. The BCSR control most of the functions available on the MPC860TDB and on the MPC8XXFADS.

See [4•11 "Board Control & Status Register - BCSR" on page 45](#) of MPC8XXFADS User's Manual.

5 - Support Information

In this chapter all information needed for support, maintenance and connectivity to the MPC860TFADSDB is provided.

5•1 Interconnect Signals

The MPC860TFADSDB interconnects with external devices via the following set of connectors:

- 1) P1, P2, P3, P4, P5, P6 and P8 - Logic Analyzer connectors
- 2) P9 RJ45 connector for the Fast Ethernet.
- 3) U3 Fiber Optic Transceiver (Connector not mounted on the board).
- 4) PM1, PM2, PM3 and PM4 - Mother Board Connectors
- 5) PX1, PX2, PX3 & PX4 - Expansion Connectors
- 6) MPC8XXFADS's P8 - Serial Ports' Expansion Connector^A

5•1•1 P1, P2, P3, P4, P5, P6 and P8 - Logic Analyzer Connectors

These connectors are 38 pin, receptacle MICTOR connectors made by AMP. Each connector connects to a dedicated adaptor for HP 16500 series of logic analyzer, which interconnects to two 16 bit pods. Since all the signals that appear on these connectors appear also on the mother-board connectors and on the expansion connectors, they are described there.

A. This connector is located on the Mother Board. It is documented here since its contents depends on the Daughter Board.

TABLE 5-1 P1 Interconnect Signals

<i>Pin #</i>	<i>Signal Name</i>	<i>Pin #</i>	<i>Signal Name</i>
1	N.C.	2	N.C.
3	GND	4	N.C.
5	TS~	6	TA~
7	TS~	8	TA~
9	F_CS~	10	VFLS0
11	BCSRCS~	12	VFLS1
13	DRMCS1~	14	AT0
15	DRMCS2~	16	AT1
17	SDRMCS~	18	AT2
19	CS5~	20	AT3
21	CS6~	22	VF0
23	CS7~	24	VF1
25	N.C.	26	VF2
27	R_W~	28	WAIT_B~
29	REG_A~	30	RESETA
31	TSIZE1	32	POE_A~
33	BURST~	34	MODCK1
35	TEA~	36	MODCK2
37	SPKROUT	38	EXTCLK

TABLE 5-1 P2 - Interconnect Signals

<i>Pin #</i>	<i>Signal Name</i>	<i>Pin #</i>	<i>Signal Name</i>
1	N.C.	2	N.C.
3	GND	4	N.C.
5	NC	6	BSWE0~
7	ALE_A	8	BSWE0~
9	CE1A~	10	BSWE1~
11	CE2A~	12	BSWE2~
13	BWAITA~	14	BSWE3~
15	BB~	16	WE0~
17	BR~	18	WE1~
19	BWP	20	WE2~

TABLE 5-1 P2 - Interconnect Signals

<i>Pin #</i>	<i>Signal Name</i>	<i>Pin #</i>	<i>Signal Name</i>
21	BCD2~	22	WE3~
23	BCD1~	24	DRM_W~
25	BG~	26	EDOOE~
27	BI~	28	GPL2~
29	BRDY	30	GPL3~
31	BADDR28	32	GPL4A~
33	BADDR29	34	GPL4B~
35	BADDR30	36	GPL5A~
37	AS~	38	GPL5B~

TABLE 5-2. P3 - Interconnect Signals

<i>Pin #</i>	<i>Signal Name</i>	<i>Pin #</i>	<i>Signal Name</i>
1	N.C.	2	N.C.
3	GND	4	
5	TEA~	6	
7	A0	8	A16
9	A1	10	A17
11	A2	12	A18
13	A3	14	A19
15	A4	16	A20
17	A5	18	A21
19	A6	20	A22
21	A7	22	A23
23	A8	24	A24
25	A9	26	A25
27	A10	28	A26
29	A11	30	A27
31	A12	32	A28
33	A13	34	A29
35	A14	36	A30
37	A15	38	A31

TABLE 5-3. P5 - Interconnect Signals

<i>Pin #</i>	<i>Signal Name</i>	<i>Pin #</i>	<i>Signal Name</i>
1	N.C.	2	N.C.
3	GND	4	
5	MIITCLK	6	
7	UUFEN~	8	DSDI
9	FETHFDE	10	DSCK
11	FETHCFG1	12	DSDO
13	FETHCFG0	14	TMS
15	FETHRST~	16	TRST~
17	BVS1	18	NMI~
19	BVS2	20	IRQ1~
21	BBVD1	22	IRQ2~
23	BBVD2	24	IRQ3~
25	RSTCNF~	26	FRZ
27	TEXP	28	BINPAK~
29	HRESET~	30	DP0
31	SRESET~	32	DP1
33	PORST~	34	DP2
35	R_POR1~	36	DP3
37	MIITCLK	38	V3.3

TABLE 5-4. P6 - Interconnect Signals

<i>Pin #</i>	<i>Signal Name</i>	<i>Pin #</i>	<i>Signal Name</i>
1	N.C.	2	N.C.
3	GND	4	N.C.
5	N.C.	6	SYSCLK
7	PB14	8	SYSCLK
9	PB15	10	PB30
11	PB16	12	PB31
13	PB17	14	PC4
15	PB18	16	PC5
17	E_TENA	18	PC6
19	RSRXD2	20	PC7

TABLE 5-4. P6 - Interconnect Signals

<i>Pin #</i>	<i>Signal Name</i>	<i>Pin #</i>	<i>Signal Name</i>
21	RSTXD2	22	PC8
23	RSDTR2~	24	PC9
25	RSDTR1~	26	E_RENA
27	RSRXD1	28	E_CLSN
29	RSTXD1	30	PC12
31	PB26	32	PC13.
33	PB27	34	PC14
35	PB28	36	MIICOL
37	PB29	38	N.C.

TABLE 5-5. P4 - Interconnect Signals

<i>Pin #</i>	<i>Signal Name</i>	<i>Pin #</i>	<i>Signal Name</i>
1	N.C.	2	N.C.
3	GND	4	
5	N.C.	6	MIIRXCLK
7	PA0	8	MIIRXD3
9	PA1	10	MIIRXD2
11	PA2	12	MIIRXD1
13	PA3	14	MIIMDC
15	PA4	16	MIITXER
17	PA5	18	MIIRXD0
19	PA6	20	MIITXD0
21	PA7	22	MIIRXCLK
23	PA8	24	MIIRXER
25	PA9	26	MIIRXDV
27	PA10	28	MIITXD3
29	PA11	30	MIITXD2
31	IRDTXD	32	MIITXD1
33	IRDRXD	34	MIICRS
35	ETHTX	36	MIIMDIO
37	ETHRXS	38	MIITXEN

TABLE 5-6. P8 - Interconnect Signals

<i>Pin #</i>	<i>Signal Name</i>	<i>Pin #</i>	<i>Signal Name</i>
1	N.C.	2	N.C.
3	GND	4	N.C.
5	N.C.	6	N.C.
7	D0	8	D16
9	D1	10	D17
11	D2	12	D18
13	D3	14	D19
15	D4	16	D20
17	D5	18	D21
19	D6	20	D22
21	D7	22	D23
23	D8	24	D24
25	D9	26	D25
27	D10	28	D26
29	D11	30	D27
31	D12	32	D28
33	D13	34	D29
35	D14	36	D30
37	D15	38	D31

5•1•2 P9 & U3 - Fast Ethernet Connector

The 823FADSDB supports both types of connectors for fast ethernet RJ45 (P3) and fiber optic transceiver (it is not mounted on the board) U3. The signals of P9 are described in [TABLE 5-7. "P9 Interconnect Signal"](#) below:

TABLE 5-7. P9 Interconnect Signal

<i>Pin No.</i>	<i>Signal Name</i>
1	TPO-
2	TPO+
3	TPI+
4	COMMON_O
5	COMMON_O
6	TPI-

TABLE 5-7. P9 Interconnect Signal

<i>Pin No.</i>	<i>Signal Name</i>
7	COMMON_I
8	COMMON_I

5•1•3 P7 - LCD Panel Connector Interconnect Signals

The LCD Panel connector is a 40 pin (2 X 20) header connector, which is compatible with the LCD panel connector, existed on the MPC821ADS To allow convenient migration for MPC821 users, the signal are assigned in a way that allows for panels that were connected to the MPC821ADS, to be connected directly. The signals of P7 are described in [TABLE 5-8. "P7 Interconnect Signals" below](#):

TABLE 5-8. P7 Interconnect Signals

<i>Pin No.</i>	<i>Signal Name</i>	<i>Attribute</i>	<i>Description</i>
1	SHIFT_C	I/O	LCD Shift Clock.
2	GND	-	
3			
4			
5	LOE	I/O	Output Enable for TFT displays or Passive panels LCD_AC~signal.
6	GND	-	
7	HSYNC	I/O	Display Line beginning mark.
8	GND	-	
9	VSYNC	I/O	New Frame beginning mark.
10	GND	-	
11			
12			
13	LD0	I/O	LCD Data Line 0.
14	GND	-	
15	LD1	I/O	LCD Data Line 1.
16	GND	-	
17	LD2	I/O	LCD Data Line 2.
18	GND	-	
19	LD3	I/O	LCD Data Line 3.
20	GND	-	
21	LD4	I/O	LCD Data Line 4.
22	GND	-	

TABLE 5-8. P7 Interconnect Signals

<i>Pin No.</i>	<i>Signal Name</i>	<i>Attribute</i>	<i>Description</i>
23	LD5	I/O	LCD Data Line 5.
24	GND	-	
25	LD6	I/O	LCD Data Line 6.
26	GND	-	
27	LD7	I/O	LCD Data Line 7.
28	GND	-	
29	LD8	I/O	LCD Data Line 8.
30	GND	-	
31	N.C.	-	Pin is cut to allow 30 pin connector insertion.
32			
33			
34			
35	N.C.	I/O	Mux'ed on PB31. The MSB for the LCD data word.
36	VCC	O	5V supply.
37	N.C.	I/O	Mux'ed on PB19. The middle of the additional 3 LCD data bits.
38	VCC	O	5V supply.
39	N.C.	I/O	Mux'ed on PB17. The LSB of the additional 3 LCD data bits.
40	VCC	O	5V supply.

5•1•4 PM1 - PM4, Mother Board Connectors

These connectors which connect to their mates on the motherboard (hence their name) are 140 pin inter-board, mail connectors made by Molex. These connectors are arranged in a quadratic shape, this to provide the shortest PCB routes as possible. As can be seen from their mechanical assembly shown in [FIGURE 5-1 "Motherboard Connectors Mechanical Assembly" below](#) - the connectors are not set in a perfect symmetric shape, this, to prevent the possibility of daughter-board's miss-insertion.

FIGURE 5-1 Motherboard Connectors Mechanical Assembly^{A B}



The motherboard connectors's signals are described in [TABLE 5-9. "PM1 Interconnect Signals"](#) on page 23, [TABLE 5-10. "PM2 Interconnect Signals"](#) on page 28, [TABLE 5-11. "PM3 Interconnect Signals"](#) on page 36 and [TABLE 5-12. "PM4 Interconnect Signals"](#) on page 43. [TABLE 5-13. "PX1 -](#)

- A. Top View (from Component side)
- B. All measures are in mm.

PM1 Interconnect Signals' Differences" on page 49

TABLE 5-9. PM1 Interconnect Signals

<i>Pin No.</i>	<i>Signal Name</i>	<i>Attribute</i>	<i>Description</i>
1	BB~	I/O, L	MPC's Bus Busy signal. Pulled - up on the FADS.
2	VCC	-	
3	DRM_W~	I,L	MPC's GPL0~ lines used as R/W~ signal for the DRAM simm or as A10 line for the SDRAM.
4	VCC	-	5V Bus.
5	TEA~	I/O, L, O.D.	Transfer Error Acknowledge. Pulled-up, not driven on board.
6	VCC		
7	BR~	I/O,L	MPC's Bus Request signal. Pulled - up on the FADS, but otherwise unused.
8	VCC		
9	BURST~	I/O, L	MPC's Burst indication. Pulled - up on the FADS, but otherwise unused.
10	VCC		
11	GPL4A~	X,L	UPMA general purpose line 4. Not used on the FADS.
12	VCC		
13	TA~	I/O, L	MPC's transfer Acknowledge signal. Indicates end of bus cycle, used with FADS logic.
14	VCC		
15	TS~	I/O, L	MPC's Transfer Start indication. Pulled - up, but otherwise unused on the FADS.
16	VCC		
17	GPL5B~	O, L	General Purpose Line 5 of UPMB. Not used on the FADS.
18	VCC		
19	BG~	I/O, L	MPC's Bus grant signal. Pulled - up on the FADS, but otherwise unused.
20	VCC		
21	GPL4B~	O, L	General Purpose Line 4 of UPMB. Not used on the FADS.
22	VCC		
23	R_W~	I/O, L	MPC's Read/Write~ indication. Pulled - up on the FADS and used by FADS logic.
24	VCC		
25	BCSRCS~	I/O, L	In fact CS1~ of the MPC. Used as chip-select for the BCSRs. Pulled - up. When BCSR is removed from the local map, may be used off-board via the daughter-board's expansion connectors.
26	VCC	O	5V Bus.

TABLE 5-9. PM1 Interconnect Signals

<i>Pin No.</i>	<i>Signal Name</i>	<i>Attribute</i>	<i>Description</i>
27	GPL5A~	X,L	UPMA general purpose line 5. Not used on the FADS.
28	VCC	O	5V Bus.
29	BI~	I/O,L	MPC's Burst Inhibit input. Pulled - up, but otherwise unused on the FADS.
30	N.C.	-	Not Connected. Reserved.
31	CS7~		
32	GND	-	FADS Ground plane.
33	CS5~	-	MPC's Chip Select line 5. Unused on the FADS.
34	GND		
35	CE1A~	I, L	PC-Card Enable 1 for PCMCIA slot A. Enables the EVEN address bytes. Used by on-board PCMCIA port.
36	GND		
37	F_CS~	I/O, L	In fact MPC's chip-select line 0. Used as chip-select for the Flash Simm. Pulled - up. When the Flash is disabled via BCSR, may be used off-board via the daughter-board's expansion connectors.
38	GND		
39	CS6~	-	MPC's Chip Select line 6. Unused on the FADS.
40	GND		
41	CE2A~	I, L	PC-Card Enable 2 for PCMCIA slot A. Enables the ODD address bytes. Used by on-board PCMCIA port.
42	GND		
43	DRMCS2~	I/O, L	In fact MPC's chip-select line 3. Used as chip-select line for the 2'nd bank of the Dram Simm. Pulled - up. When the Dram is disabled via BCSR or when a single-bank Dram Simm is being used - may be used off-board via the daughter board's expansion connectors.
44	GND		
45	DRMCS1~	I/O, L	In fact MPC's chip-select line 2. Used as chip-select line for the 1'st bank of the Dram Simm. Pulled - up. When the Dram is disabled via BCSR - may be used off-board via the daughter board's expansion connectors.
46	GND		
47	SDRMCS~	I/O, L	In fact MPC's chip-select line 4. Used as chip-select for the Synchronous Dram. Pulled - up. When the SDRAM is disabled via BCSR, may be used off-board via the daughter board
48	GND		
49	GPL3~	I/O, L	UPMA or UPMB general purpose line 3. Used as WR~ signal for the SDRAM.
50	GND		

TABLE 5-9. PM1 Interconnect Signals

<i>Pin No.</i>	<i>Signal Name</i>	<i>Attribute</i>	<i>Description</i>
51	GPL2~	I, L	General Purpose Line 2 for UPMA or UPMB. Used with the SDRAM, as a CAS~ signal.
52	GND		
53	WE3~	I, L	GPCM Write Enable 3 or PCMCIA WE~. Selects the LSB within a word for the Flash Simm or qualifies Writes for the PC-Card.
54	GND		
55	WE2~	I, L	GPCM Write Enable 2 or PCMCIA OE~. Selects the offset 2 Byte within a word for the Flash Simm or open data buffers for read from PC-Card.
56	GND		
57	WE1~	I, L	GPCM Write Enable1 or PCMCIA I/O Write. Used to qualify write cycles to the Flash memory and as I/O Write for the PCMCIA channel.
58	GND		
59	BS2A~	I, L	Byte Select 2 for UPMA. Selects offset 2 bytes within Word. Used for Dram access.
60	GND		
61	WE0~	I, L	GPCM Write Enable 0 or PCMCIA I/O Read. Used to qualify write cycles to the Flash memory and as I/O Reads from PC-Card.
62	GND		
63	SPARE1	I,O, L	MPC spare line 1. Pulled - up but otherwise unused on the FADS.
64	GND		
65	EDOOE~	I,L	In fact UPMA or UPMB General Purpose Line 1. Used for Output Enable with EDO Dram simms, which have this input (most of them don't). Used also as RAS signal for the SDRAM.
66	GND		
67	BS0A~	I, L	Byte Select 0 from UPMA. Selects offset 0 Bytes within a word. Used as one of the CAS~ lines for Dram access.
68	GND		
69	BS3A~	I, L	Byte Select 3 from UPMA. Selects offset 3 Bytes within a word. Used as one of the CAS~ lines for Dram access.
70	GND		
71	A31	I, T.S.	MPC's Address line 31.
72	GND		
73	BS1A~	I, L	Byte Select 1 from UPMA. Selects offset 1 Bytes within a word. Used as one of the CAS~ lines for Dram access.
74	GND		

TABLE 5-9. PM1 Interconnect Signals

<i>Pin No.</i>	<i>Signal Name</i>	<i>Attribute</i>	<i>Description</i>
75	TSIZ1	x, T.S.	Transfer Size 1. Used in conjunction with TSIZ0 to indicate the number of bytes remaining in an operand transfer. Not used on the FADS.
76	GND		
77	REG_A~	I, T.S., L	In fact TSIZ0/REG~. Transfer Size 0 or PCMCIA slot A REG~. Used with the PCMCIA port as Attribute memory select or I/O space select.
78	GND		
79	A30	I, T.S.	MPC's Address line 30.
80	GND		
81	A21	I, T.S.	MPC's Address line 21.
82	GND		
83	A20	I, T.S.	MPC's Address line 20.
84	GND		
85	A7	I, T.S.	MPC's Address line 7.
86	GND		
87	A15	I, T.S.	MPC's Address line 15.
88	GND		
89	A14	I, T.S.	MPC's Address line 14.
90	GND		
91	A13	I, T.S.	MPC's Address line 13.
92	GND		
93	A6	I, T.S.	MPC's Address line 6.
94	GND		
95	A12	I, T.S.	MPC's Address line 12.
96	GND		
97	A11	I, T.S.	MPC's Address line 11.
98	GND		
99	A19	I, T.S.	MPC's Address line 19.
100	GND		
101	A9	I, T.S.	MPC's Address line 9.
102	GND		
103	A18	I, T.S.	MPC's Address line 18.
104	GND		

TABLE 5-9. PM1 Interconnect Signals

<i>Pin No.</i>	<i>Signal Name</i>	<i>Attribute</i>	<i>Description</i>
105	A10	I, T.S.	MPC's Address line 10.
106	GND		
107	A17	I, T.S.	MPC's Address line 17.
108	GND		
109	A16	I, T.S.	MPC's Address line 16.
110	GND		
111	A8	I, T.S.	MPC's Address line 8.
112	GND		
113	A29	I, T.S.	MPC's Address line 29.
114	GND		
115	A27	I, T.S.	MPC's Address line 27.
116	GND		
117	A28	I, T.S.	MPC's Address line 28.
118	GND		
119	A26	I, T.S.	MPC's Address line 26.
120	GND		
121	A25	I, T.S.	MPC's Address line 25.
122	GND		
123	A24	I, T.S.	MPC's Address line 24.
124	GND		
125	A22	I, T.S.	MPC's Address line 22.
126	GND		
127	A3	I, T.S.	MPC's Address line 3. Not used on the FADS.
128	GND		
129	A23	I, T.S.	MPC's Address line 23.
130	GND		
131	A4	I, T.S.	MPC's Address line 4. Not used on the FADS.
132	GND		
133	A2	I, T.S.	MPC's Address line 2. Not used on the FADS.
134	GND		
135	A5	I, T.S.	MPC's Address line 5. Not used on the FADS.
136	GND		
137	A1	I, T.S.	MPC's Address line 1. Not used on the FADS.

TABLE 5-9. PM1 Interconnect Signals

<i>Pin No.</i>	<i>Signal Name</i>	<i>Attribute</i>	<i>Description</i>
138	GND		
139	A0	I, T.S.	MPC's Address line 0. Not used on the FADS.
140	GND		

TABLE 5-10. PM2 Interconnect Signals

<i>Pin No.</i>	<i>Signal Name</i>	<i>Attribute</i>	<i>Description</i>
1	V12	O	10V output from voltage doubler. Used to switch TMOS gates on both mother and daughter boards. Should not be used for any other purpose.
2			
3			
4			
5	N.C.		
6			
7	DSDI	I/O	DSDI/TDI. Debug Port Serial Data Input or JTAG port serial Data Input. Used on the FADS as debug port serial data, driven by the debug-port controller. If the ADI bundle is not connected to the FADS, may be driven by external debug / JTAG ^a port controller.
8	GND		
9			
10	DSCK	I/O	DSCK/TCK. Debug Port Serial Clock input or JTAG port serial clock input. Used on the FADS as debug port serial clock, driven by the debug-port controller. If the ADI bundle is not connected to the FADS, may be driven by an external debug / JTAG ^a port controller.
11	DSDO	I	DSDO/TDO. Debug Port Serial Data Output or JTAG port Data Output. Used on the FADS as debug port serial data. If the ADI bundle is not connected to the FADS, may be used by an external debug / JTAG ^a port controllers.
12	GND		
13			
14	AT2	I/O	IP_B2/IOIS16~/AT2. PCMCIA slot B Input Port 2 or PCMCIA 16 bit I/O capability indication or Address Type 2. For MPC823 or MPC850 daughter boards - configured as IP_B2/IOIS16~. For all other daughter boards, configured as AT2, but may be configured to alternate function as no use is done with AT2 on the FADS.
15	GND		

TABLE 5-10. PM2 Interconnect Signals

<i>Pin No.</i>	<i>Signal Name</i>	<i>Attribute</i>	<i>Description</i>
16	VF2	I/O	IP_B3/IWP2/VF2. PCMCIA slot B Input Port 3 or Instruction Watch-Point 2 or Visible Instruction Queue Flushes Status 2. For MPC823 or MPC850 daughter boards - configured as IP_B3. For all other daughter boards, configured as VF2, but may be configured to alternate function as no use is done with VF2 on the FADS.
17	GND		
18	VF0	I/O	IP_B4/LWP0/VF0. PCMCIA slot B Input Port 4 or Data Watch-Point 0 or Visible Instruction Queue Flushes Status 0. For MPC823 or MPC850 daughter boards - configured as IP_B4. For all other daughter boards, configured as VF0, but may be configured to alternate function as no use is done with VF0 on the FADS.
19	GND		
20			
21			
22	IRQ3~	I/O, L	IRQ3~/CR~. MPC's interrupt request 3 or Cancel Reservation. Pulled - up but otherwise not used on the FADS.
23	GND		
24	FRZ	I, X	Freeze / IRQ6~. MPC debug state indication or Interrupt request line 6. Used by the debug port controller as debug state indication. May be configured to alternate function provided that VFLS(0:1) function as VFLS and J1 is moved to position 1-2.
25	GND		
26	IRQ2~	I/O, L	RSV~/IRQ2~. Reservation or Interrupt Request 2. Pulled - up but otherwise unused on the FADS.
27	GND		
28			
29			
30	AT3	I/O	IP_B7/PTR/AT3. PCMCIA slot B Input Port 7 or Program Trace (instruction fetch indication or Address Type 3. For MPC823 or MPC850 daughter boards - configured as IP_B7. For all other daughter boards, configured as AT3, but may be configured to alternate function as no use is done with AT3 on the FADS.
31	GND		
32	SPARE4	I/O	MPC's spare line 4. Pulled - up but otherwise unused on the FADS.
33	GND		

TABLE 5-10. PM2 Interconnect Signals

<i>Pin No.</i>	<i>Signal Name</i>	<i>Attribute</i>	<i>Description</i>
34	VFLS0	I/O	IP_B0/IWP0/VFLS0. PCMCIA slot B Input Port 0 or Instruction Watchpoint 0 or Visible history Flushes Status 0. For the MPC823 or MPC850 daughter boards, configured as IP_B0. For all other daughter boards - configured as VFLS0. May be configured to any alternate function. Indicates in conjunction with VFLS1, the number of instructions flushed from the core's history buffer. Indicates also whether the MPC is in debug mode. If not using the debug port, may be configured for alternate function.
35	GND		
36	SPKROUT	I, X	KR~/IRQ4~/SPKROUT. Kill Reservation input or Interrupt Request 4 input or PCMCIA Speaker Output. Configured on the FADS as SPKROUT. May be configured to alternate function.
37	GND		
38	VFLS1	I/O	IP_B1/IWP1/VFLS1. PCMCIA slot B Input Port 1 or Instruction Watchpoint 1 or Visible history Flushes Status 1. For the MPC823 or MPC850 daughter boards, configured as IP_B1. For all other daughter boards - configured as VFLS0. May be configured. Indicates in conjunction with VFLS1, the number of instructions flushed from the core's history buffer. Indicates also whether the MPC is in debug mode. If not using the debug port, may be configured for alternate function.
39	GND		
40			
41			
42	VF1	-	IP_B5/LWP1/VF1. PCMCIA slot B Input Port 5 or Load/Store Watch-Point 1 or Visible Instruction Queue Flushes Status 1. For MPC823 or MPC850 configured as IP_B5, for all other daughter boards configured as VF1. May be configured to any alternate function as no use is done with it on the FADS.
43	GND		
44	AT1	-	ALE_B/DSCK/AT1. Address Latch Enable for PCMCIA slot B or Debug Serial Clock or Address Type 1. For MPC823 or MPC850 daughter boards configured as ALE_B for all other daughter boards configured as AT1. Not used on the FADS. May be configured to any alternate function.
45	GND		
46	AT0	I	IP_B6/DSDI/AT0. Input Port B 6 or Debug Serial Data Input or Address Type 0. Configured on the as AT0. May be used for alternate function.
47	GND		
48	POE_A~	I, L	In fact OP1 of the PCMCIA I/F. Enables address buffers towards the PC-Card.

TABLE 5-10. PM2 Interconnect Signals

<i>Pin No.</i>	<i>Signal Name</i>	<i>Attribute</i>	<i>Description</i>
49	GND		
50			
51			
52	BADDR30	I/O,X	Burst Address Line 30. Dedicated for external master support. Used to generate Burst address during external master burst cycles. Pulled - up but otherwise unused on the FADS.
53	GND		
54	ALE_A	I, H	Address Latch Enable for PCMCIA slot A. Latches address in external latches at the beginning of access to a PC-Card.
55	GND		
56	BADDR29	I/O,X	Burst Address Line 29. Dedicated for external master support. Used to generate Burst address during external master burst cycles. Pulled - up but otherwise unused on the FADS.
57	GND		
58	AS~	I/O, L	Asynchronous external master Address Strobe signal. When asserted (L) by the external master, the MPC recognizes an asynchronous cycle in progress. Pulled - up but otherwise unused on the FADS.
59	GND		
60	MODCK1	I/O	OP2/MODCK1/STS~. PCMCIA Output Port 2 or Mode Clock 1 input or Special Transfer Start output. Used at Power-On reset as MODCK1. For MPC823 or MPC850 daughter boards configured afterwards as a OP2 for all other daughter boards configured afterwards as STS~.
61	GND		
62	RESETA	I,H	PC-Card reset signal.
63	GND		
64			
65			
66	BADDR28	I/O,X	Burst Address Line 28. Dedicated for external master support. Used to generate Burst address during external master burst cycles. Pulled - up but otherwise unused on the FADS.
67	GND		
68	TEXP	X,X	MPC Timer Expired. Not used on the FADS.
69	GND		
70	WAIT_B~	I/O, L	This signal is PCMCIA slot B wait signal. Pulled-up but otherwise not used on the FADS.
71	GND		

TABLE 5-10. PM2 Interconnect Signals

<i>Pin No.</i>	<i>Signal Name</i>	<i>Attribute</i>	<i>Description</i>
72	MODCK2	I/O	OP3/MODCK2/DSDO. PCMCIA Output Port 3 or Mode Clock 2 input or Special Transfer Start output. Used at Power-On reset as MODCK2 and configured afterwards as a OP3. May be used with alternate function.
73	GND		
74			
75			
76	N.C.		
77	GND		
78			
79			
80	SRESET~	I/O, L, O.D.	MPC Soft Reset. Driven by on-board logic and may be driven by off-board logic with Open-Drain gate only.
81	GND		
82	PORST~	X, L	Power On reset for the MPC. Not used on the FADS, generated on the daughter boards
83	GND		
84	HRESET~	I/O, L, O.D.	MPC Hard Reset. Driven by on-board logic and may be driven by off-board logic with Open-Drain gate only.
85	GND		
86	RSTCNF~	O, L	Hard Reset Configuration output. Driven during Hard Reset to the daughter board to signal the MPC that it should sample Hard Reset configuration from the data bus.
87	GND		
88	R_PORI~	O, L	Main battery power-on reset. Generated as a result of main 3.3V bus going through power up or power-down. Drives on-board logic as well either HARD-RESET or Power-On reset to the MPC.
89	GND		
90			
91			
92	BWAITA~	O, L	Buffered PCMCIA slot A WAIT signal. Used to prolong cycles to slow PC-Cards. In case of MPC823 or MPC850 daughter boards, connected to WAIT_B~ signal of the MPC.
93	GND		
94	BWP	O, H	Buffered PCMCIA slot A Write Protect. In fact IP_A2/IOIS16A~. Used as PC-card write protect indication or as 16 bit I/O capability indication for PCMCIA slot A. In case of MPC823 or MPC850 daughter boards, connected to IP_B2 signal of the MPC.

TABLE 5-10. PM2 Interconnect Signals

<i>Pin No.</i>	<i>Signal Name</i>	<i>Attribute</i>	<i>Description</i>
95	GND		
96	BVS1	O,X	Buffered PCMCIA slot A Voltage Sense 1. In fact IP_A0. Used in conjunction with BVS2 to determine the operation voltage of a PCMCIA card. In case of MPC823 or MPC850 daughter boards, connected to IP_B0 signal of the MPC.
97	GND		
98	BRDY	O, H	Buffered PCMCIA slot A Ready signal. In fact IP_A7. Used as PCMCIA port A Card Ready indication. In case of MPC823 or MPC850 daughter boards, connected to IP_B7 signal of the MPC.
99	GND		
100			
101			
102	DP3	I/O, X	DP3/IRQ6~. Data Parity line 3 or Interrupt Request 6. May generate and receive parity data for D(24:31) bits connected to the DRAM SIMM. May also be configured as IRQ6~ input for the MPC.
103	GND		
104	BVS2	O, X	Buffered PCMCIA slot A Voltage Sense 2. In fact IP_A1. Used in conjunction with BVS1 to determine the operation voltage of a PCMCIA card. In case of MPC823 or MPC850 daughter boards, connected to IP_B1 signal of the MPC.
105	GND		
106	BCD1~	O, L	Buffered PCMCIA slot A Card Detect 1. In fact IP_A4. Input Port 4 of PCMCIA slot A. Used as Card Detect indication in conjunction with BCD2~. In case of MPC823 or MPC850 daughter boards, connected to IP_B4 signal of the MPC.
107	GND		
108	MODIN	O, X	This signal selects between clock generator and the 32768 Hz crystal as clock sources for the MPC. Its is driven by DS2/4. See 2•3•2 "Clock Source Selection "on page 7. In the motherboard documentations.
109	GND		
110	BBVD1	O, X	Buffered PCMCIA slot A Battery Voltage Detect 1. In fact IP_A6. Used in conjunction with BBVD2 to determine the battery status of a PC-Card. In case of MPC823 or MPC850 daughter boards, connected to IP_B6 signal of the MPC.
111	GND		
112	BCD2~	O, L	Buffered PCMCIA slot A Card Detect 2. In fact IP_A3. Input Port 3 of PCMCIA slot A. Used as Card Detect indication in conjunction with BCD1~. In case of MPC823 or MPC850 daughter boards, connected to IP_B3 signal of the MPC.
113	GND		

TABLE 5-10. PM2 Interconnect Signals

<i>Pin No.</i>	<i>Signal Name</i>	<i>Attribute</i>	<i>Description</i>
114	BBVD2	O, X	Buffered PCMCIA slot A Battery Voltage Detect 2. In fact IP_A5. Used in conjunction with BBVD1 to determine the battery status of a PC-Card. In case of MPC823 or MPC850 daughter boards, connected to IP_B5 signal of the MPC.
115	GND		
116			
117	N.C.		
118	DP0	I/O	DP0/IRQ3~. Data Parity line 0 or Interrupt Request 3. May generate and receive parity data for D(0:7) bits connected to the DRAM SIMM. May not be configured as IRQ3~.
119	V3.3		
120	DP2	I/O	DP2/IRQ5~. Data Parity line 2 or Interrupt Request 5. May generate and receive parity data for D(16:23) bits connected to the DRAM SIMM. May not be configured as IRQ5~.
121	V3.3		
122	DP1	I/O	DP1/IRQ4~. Data Parity line1 or Interrupt Request 4. May generate and receive parity data for D(8:15) bits connected to the DRAM SIMM. May not be configured as IRQ4~.
123	V3.3		
124	N.C.		
125	V3.3		
126	IRQ1~	I/O, L	Interrupt Request 1. Pulled-up but otherwise not used on the FADS.
127	V3.3		
128	SPARE3	I/O, X	MPC's spare line 3. Pulled - up but otherwise unused on the FADS.
129	V3.3		
130	IRQ7~	I/O, L	Interrupt Request 7. The lowest priority interrupt request line. Pulled - up but otherwise not used on the FADS.
131	V3.3		
132	N.C.		
133	V3.3		
134	NMI~	I/O, L	Non-Makable Interrupt. In fact IRQ0~ of the MPC. Driven by on-board logic by O.D. gate. Pulled - up. May be driven off-board by O.D. gate only.
135	V3.3		
136	N.C.		
137	V3.3		

TABLE 5-10. PM2 Interconnect Signals

<i>Pin No.</i>	<i>Signal Name</i>	<i>Attribute</i>	<i>Description</i>
138	N.C.		
139	V3.3		
140	N.C.		

a. Be aware that TRST~ is connected to GND with a zero ohm resistor.

PRELIMINARY

TABLE 5-11. PM3 Interconnect Signals

<i>Pin No.</i>	<i>Signal Name</i>	<i>Attribute</i>	<i>Description</i>
1	ETHRX	O, X	Ethernet port Receive Data. When the ethernet port is disabled via BCSR1 - tri-stated. Appears also at P8.
2	GND		
3			
4	UUFEN~	O, L	When this signal is active (LOW) it enable the LXT970 device. This signal connected to the TRSTE signal of the LXT970. In DTE mode when this pin is high the LXT970 isolate it self from the MII data interface. In repeater mode when it is high the LXT970 tree state the MII output pins.
5	ETHTX	I, X	Ethernet Port Transmit Data. Appears also at P8.
6	GND		
7			
8	PC9	X, X	MPC's PI/O C 9 pin. Appears also at P8 but otherwise unused on the FADS.
9	IRDRXD	O, X	InfraRed Port Receive Data. When the I/R port is disabled via BCSR1 - tri-stated. Appears also at P8.
10	GND		
11	IRDTXD	I, X	InfraRed Port Transmit Data. Appears also at P8.
12	GND		
13			
14	PC8	I/O, X	MPC PI/O port C 8. Appears also at P8 but otherwise unused.
15	PA11	I/O, X	MPC PI/O port A 11. Appears also at P8 but otherwise unused.
16	GND		
17	PA10	I/O, X	MPC PI/O port A 10. Appears also at P8 but otherwise unused.
18	GND		
19			
20	PC7	I/O, X	MPC PI/O port C 7. Appears also at P8 but otherwise unused.
21	PA9	I/O, X	MPC PI/O port A 9. Appears also at P8 but otherwise unused.
22	GND		
23	PA8	I/O, X	MPC PI/O port A 9. Appears also at P8 but otherwise unused.
24	GND		
25			
26	PC13	I/O, X	MPC PI/O port C 13. Appears also at P8 but otherwise unused.

TABLE 5-11. PM3 Interconnect Signals

<i>Pin No.</i>	<i>Signal Name</i>	<i>Attribute</i>	<i>Description</i>
27	ETHTCK	O, X	Ethernet port Transmit Clock. When the ethernet port is disabled via BCSR1 - tri-stated. Appears also at P8.
28	GND		
29	ETHRCK	O, X	Ethernet port Receive Clock. When the ethernet port is disabled via BCSR1 - tri-stated. Appears also at P8.
30	GND		
31			
32	FETHCFG0	O, X	Fast Ethernet CFG0 signal When the LXT970 is in auto negotiation a low to high transition in this pin cause an auto negotiate to re-start. When auto negotiation is disabled this input selects operating speed bit 0.13 When this pin is high the 100Mbps is selected 0.13 = 1. When this pin is low the 10Mbps is selected 0.13 = 0.
33	PB31	I/O, X	MPC PI/O port B 31. Appears also at P8 but otherwise unused.
34	BINPAK~	I/O	PCMCIA port Input Port Acknowledge. In fact PC15/DREQ1~/RTS1~/L1ST1. When the PCMCIA port is disabled via BCSR1, may be used off-board for any alternate function.
35	PB30	I/O, X	MPC PI/O port B 30. Appears also at P8 but otherwise unused.
36	GND		
37	PB29	I/O, X	MPC PI/O port B 29. Appears also at P8 but otherwise unused.
38	RSTXD1	I, X	RS232 Port 1 Transmit Data. When RS232 port 1 is disabled via BCSR1, may be used for any alternate function. Appears also at P8.
39	RSRXD1	O, X	RS232 Port 1 Receive Data. When RS232 port 1 is disabled via BCSR1 - tri-stated and may be used for any alternate function. Appears also at P8.
40	RSDTR1~	O, L	RS232 port 1 DTR~ signal. When RS232 port 1 is disabled via BCSR1 - tri-stated and may be used for any alternate function. Appears also at P8.
41	GND		
42	RSTXD2	I, X	RS232 Port 2 Transmit Data. When RS232 port 2 is disabled via BCSR1, may be used for any alternate function. Appears also at P8.
43	RSRXD2	O, X	RS232 Port 2 Receive Data. When RS232 port 2 is disabled via BCSR1 - tri-stated and may be used for any alternate function. Appears also at P8.
44	RSDTR2~	O, L	RS232 port 2 DTR~ signal. When RS232 port 2 is disabled via BCSR1 - tri-stated and may be used for any alternate function. Appears also at P8.
45	PC14	I/O, X	MPC PI/O port C 14. Appears also at P8 but otherwise unused.
46	GND		

TABLE 5-11. PM3 Interconnect Signals

<i>Pin No.</i>	<i>Signal Name</i>	<i>Attribute</i>	<i>Description</i>
47	N.C.		
48	GND		
49			
50	PB27	I/O, X	MPC PI/O port B 27. Appears also at P8 but otherwise unused.
51	PB28	I/O, X	MPC PI/O port B 28. Appears also at P8 but otherwise unused.
52	GND		
53	PC12	I/O, X	MPC PI/O port C 12. Appears also at P8 but otherwise unused.
54	PB26	I/O, X	MPC PI/O port C 26. Appears also at P8 but otherwise unused.
55	GND		
56			
57	PA5	I/O, X	MPC PI/O port A 5. Appears also at P8 but otherwise unused.
58	GND		
59			
60	PA4	I/O, X	MPC PI/O port A 4. Appears also at P8 but otherwise unused.
61	E_CLSN	I/O, H	Ethernet Port Collision indication signal. Connected to the SCC's CTS~ signal. When the ethernet port is disabled via BCSR1, may be used off-board for any alternate function.
62	E_RENA	I/O, H	Ethernet Receive Enable. Connected to the SCC's CD~ signal. Active when there is network activity. When the ethernet port is disabled via BCSR1, may be used off-board for any alternate function.
63	SPARE2	I/O, X	MPC spare line 2. Pulled - up but otherwise unused on the FADS.
64	VDOEN~	O, L	Applies only for MPC823 daughter board. Video Encoder Enable Indication. Generated by BCSR4. Not USED IN THE 860TDB
65	GND		
66			
67	SYSCLK	I, X	System Clock. In fact the CLKOUT of the MPC.
68	GND		
69			
70			
71	PA3	I/O, X	MPC PI/O port A 3. Appears also at P8 but otherwise unused.
72	GND		
73			
74	PA2	I/O, X	MPC PI/O port A 2. Appears also at P8 but otherwise unused.
75	PB17	I/O, X	MPC PI/O port B 17. Appears also at P8 but otherwise unused.

TABLE 5-11. PM3 Interconnect Signals

<i>Pin No.</i>	<i>Signal Name</i>	<i>Attribute</i>	<i>Description</i>
76	PB18	I/O, X	MPC PI/O port B 18. Appears also at P8 but otherwise unused.
77	E_TENA	I/O, H	Ethernet port Transmit Enable. Connected to the SCC's RTS~ signal. When active, transmit is enabled via the MC68160 EEST. When the ethernet port is disabled via BCSR1, may be used off-board for any alternate function.
78	GND		
79	N.C.		
80			
81			
82	ETHEN~	O, L	Ethernet Port Enable. Connected to BCSR1. See TABLE 4-10. "BCSR1 Description" on page 49. In the motherboard documentations.
83	N.C.		
84	IRD_EN~	O, L	Infra-Red Enable. Connected to BCSR1. See TABLE 4-10. "BCSR1 Description" on page 49. In the motherboard documentations.
85	PA1	I/O, X	MPC PI/O port A 1. Appears also at P8 but otherwise unused.
86	GND		
87			
88	N.C.		
89	PA0	I/O, X	MPC PI/O port A 0. Appears also at P8 but otherwise unused.
90	GND		
91			
92	TMS	I/O, X	JTAG port Test Mode Select input. Used to select test through the JTAG port. Pulled-up but otherwise not used on the FADS.
93	PB16	I/O, X	MPC PI/O port B 16. Appears also at P8 but otherwise unused.
94	TRST~	O, L	JTAG port Reset. Pulled down with a zero ohm resistor, so that the JTAG logic is constantly reset. Otherwise unused on the FADS.
95	PB15	I/O, X	MPC PI/O port B 15. Appears also at P8 but otherwise unused.
96	RS_EN1~	O, L	RS232 port 1 Enable. Connected to BCSR1. See TABLE 4-10. "BCSR1 Description" on page 49. In the motherboard documentations.
97	PB14	I/O, X	MPC PI/O port B 14. Appears also at P8 but otherwise unused.
98	PC4	I/O, X	MPC PI/O port C 4. Appears also at P8 but otherwise unused.
99	PC5	I/O, X	MPC PI/O port C 5. Appears also at P8 but otherwise unused.
100	PC6	I/O, X	MPC PI/O port C 6. Appears also at P8 but otherwise unused.
101	GND		

TABLE 5-11. PM3 Interconnect Signals

<i>Pin No.</i>	<i>Signal Name</i>	<i>Attribute</i>	<i>Description</i>
102	RS_EN2~	O, L	RS232 port 1 Enable. Connected to BCSR1. See TABLE 4-10. "BCSR1 Description" on page 49. In the motherboard documentation.
103	SHIFT_C	I/O, X	MPC821's or MPC823's PD3/SHIFT/CLK or MPC860s' PD3/RRJECT4~. Not used on the FADS. Appears also at P8. On MPC823 or MPC821 daughter boards appears also at a dedicated LCD connector. On MPC823 daughter board used as Video Clock input.
104	GND		
105			
106	HSYNC	I/O, X	MPC821's or MPC823's PD4/LOAD/HSYNC or MPC860s' PD4/RRJECT3~. Not used on the FADS. Appears also at P8. On MPC823 or MPC821 daughter boards appears also at a dedicated LCD connector. On MPC823 daughter board used as HSYNC for the video encoder.
107	VSYNC	I/O, X	MPC821's or MPC823's PD5/FIELD/VSYNC or MPC860s' PD5/RRJECT2~. Not used on the FADS. Appears also at P8. On MPC823 or MPC821 daughter boards appears also at a dedicated LCD connector. On MPC823 daughter board used as FIELD signal for the video encoder.
108	GND		
109			
110	LOE	I/O, X	MPC821's or MPC823's PD6/LCD_AC/LOE or MPC860s' PD6/RTS4~. Not used on the FADS. Appears also at P8. On MPC823 or MPC821 daughter boards appears also at a dedicated LCD connector. On the MPC823 daughter board used also as BLANK~ signal for the video encoder.
111	FETHRST~	O, L	Fast Ethernet Reset. When this pin active (LOW) signal is being asserted the Fast ethernet tranceiver is being reset.
112	FETHCFG1	O, H	Fast Ethernet CFG1 signal When the LXT970 is in auto negotiation this pin determines operating speed advertisement capability in combination with MF4. see See the LXT970 documentation. When auto negotiation is disabled this input enables 10Mbps link test function and directly affects bit 19.8. When this pin is high, 10Mbps link test is disabled 19.8 = 1. When this pin is low, 10Mbps link test is enabled 19.8 = 0.
113	LD0	I/O, X	MPC821's or MPC823's PD7/LD0 or MPC860s' PD7/RTS3~. Not used on the FADS. Appears also at P8. On MPC823 or MPC821 daughter boards appears also at a dedicated LCD connector. On MPC823 daughter board used as video data 7.
114	LD1		MPC821's or MPC PD8/LD1 or MPC860s' PD8/TXD4. Not used on the FADS. Appears also at P8. On MPC823 or MPC821 daughter boards appears also at a dedicated LCD connector. On MPC823 daughter board used as video data 6.

TABLE 5-11. PM3 Interconnect Signals

<i>Pin No.</i>	<i>Signal Name</i>	<i>Attribute</i>	<i>Description</i>
115	LD2	I/O, X	MPC821's or MPC823's PD9/LD2 or MPC860s' PD9/RXD4. Not used on the FADS. Appears also at P8. On MPC823 or MPC821 daughter boards appears also at a dedicated LCD connector. On MPC823 daughter board used as video data 5.
116	LD3	I/O, X	MPC821's or MPC823's PD10/LD3 or MPC860s' PD10/TXD3. Not used on the FADS. Appears also at P8. On MPC823 or MPC821 daughter boards appears also at a dedicated LCD connector. On MPC823 daughter board used as video data 4.
117	LD4	I/O, X	MPC821's or MPC823's PD11/LD4 or MPC860s' PD11/RXD3. Not used on the FADS. Appears also at P8. On MPC823 or MPC821 daughter boards appears also at a dedicated LCD connector. On MPC823 daughter board used as video data 3.
118	LD5	I/O	MPC821's or MPC823's PD12/LD5 or MPC860s' PD12/L1RSYNCB. Not used on the FADS. Appears also at P8. On MPC823 or MPC821 daughter boards appears also at a dedicated LCD connector. On MPC823 daughter board used as video data 2.
119	LD6	I/O, X	MPC821's or MPC823's PD13/LD6 or MPC860s' PD13/L1TSYNCB. Not used on the FADS. Appears also at P8. On MPC823 or MPC821 daughter boards appears also at a dedicated LCD connector. On MPC823 daughter board used as video data 1.
120	LD7	I/O, X	MPC821's or MPC823's PD14/LD7 or MPC860s' PD14/L1RSYNCA. Not used on the FADS. Appears also at P8. On MPC823 or MPC821 daughter boards appears also at a dedicated LCD connector. On MPC823 daughter board used as video data 0.
121	LD8	I/O, X	MPC821's or MPC823's PD15/LD8 or MPC860s' PD15/L1TSYNCA. Not used on the FADS. Appears also at P8. On MPC823 or MPC821 daughter boards appears also at a dedicated LCD connector.
122	GND		
123			
124	ETHLOOP	O, H	Ethernet Transceiver Diagnostic Loop-Back Control. Generated by BCSR4. See TABLE 4-23. "BCSR4 Description" on page 57 . In the motherboard documentations.
125	TPFLDL~	O, L	Twisted Pair Full Duplex. Allows for full-duplex operation over the Ethernet Twisted-Pair channel. See TABLE 4-23. "BCSR4 Description" on page 57 . In the motherboard documentations.
126	TPSQEL~	O, L	Twisted Pair Signal Quality Error Test Enable. See TABLE 4-23. "BCSR4 Description" on page 57 . In the motherboard documentations.
127	MDM_AUD~	O, L	Applies only for MPC823 daughter board. Selects between the Data / Voice paths of the MPC821 Modem Tool. See TABLE 4-23. "BCSR4 Description" on page 57 . In the motherboard documentations.

TABLE 5-11. PM3 Interconnect Signals

<i>Pin No.</i>	<i>Signal Name</i>	<i>Attribute</i>	<i>Description</i>
128	MODEMEN~	O, L	Applies only for MPC823 daughter board. Enables the MPC821 Modem Tool as well as a multiplexer for data / voice signals on the MPC823 daughter board. See TABLE 4-23. "BCSR4 Description" on page 57. In the motherboard documentations.
129	N.C.		
130	GND		
131	N.C.		
132			
133	VCC		
134			
135			
136			
137			
138			
139			
140			

PRELIMINARY

TABLE 5-12. PM4 Interconnect Signals

<i>Pin No.</i>	<i>Signal Name</i>	<i>Attribute</i>	<i>Description</i>
1	GND		
2	D31	I/O, X	MPC's Data line 31.
3	GND		
4	D30	I/O, X	MPC's Data line 30.
5	GND		
6	D29	I/O, X	MPC's Data line 29.
7	GND		
8	D28	I/O, X	MPC's Data line 28.
9	GND		
10			
11			
12	D27	I/O, X	MPC's Data line 27.
13	GND		
14	D26	I/O, X	MPC's Data line 26.
15	GND		
16	D25	I/O, X	MPC's Data line 25.
17	GND		
18	D24	I/O, X	MPC's Data line 24.
19	GND		
20			
21			
22	D23	I/O, X	MPC's Data line 23.
23	GND		
24	D22	I/O, X	MPC's Data line 22.
25	GND		
26	D21	I/O, X	MPC's Data line 21.
27	GND		
28	D20	I/O, X	MPC's Data line 20.
29	GND		
30			
31			

TABLE 5-12. PM4 Interconnect Signals

<i>Pin No.</i>	<i>Signal Name</i>	<i>Attribute</i>	<i>Description</i>
32	D19	I/O, X	MPC's Data line 191.
33	GND		
34	D18	I/O, X	MPC's Data line 18.
35	GND		
36	D17	I/O, X	MPC's Data line 17.
37	GND		
38	D16	I/O, X	MPC's Data line 16.
39	GND		
40			
41			
42	D15	I/O, X	MPC's Data line 15.
43	GND		
44	D14	I/O, X	MPC's Data line 14.
45	GND		
46	D13	I/O, X	MPC's Data line 13.
47	GND		
48	D12	I/O, X	MPC's Data line 12.
49	GND		
50			
51			
52	D11	I/O, X	MPC's Data line 11.
53	GND		
54	D10	I/O, X	MPC's Data line 10.
55	GND		
56	D9	I/O, X	MPC's Data line 9.
57	GND		
58	D8	I/O, X	MPC's Data line 8.
59	GND		
60			
61			
62	D7	I/O, X	MPC's Data line 7.
63	GND		
64	D6	I/O, X	MPC's Data line 6.

TABLE 5-12. PM4 Interconnect Signals

<i>Pin No.</i>	<i>Signal Name</i>	<i>Attribute</i>	<i>Description</i>
65	GND		
66	D5	I/O, X	MPC's Data line 5.
67	GND		
68	D4	I/O, X	MPC's Data line 4.
69	GND		
70			
71			
72	D3	I/O, X	MPC's Data line 3.
73	GND		
74	D2	I/O, X	MPC's Data line 2.
75	GND		
76	D1	I/O, X	MPC's Data line 1.
77	GND		
78	D0	I/O, X	MPC's Data line 0.
79	GND		
80			
81	DRMH_W~	O, L	Dram Half Word. Sets the Dram to 16 bit data bus width. See TABLE 4-10. "BCSR1 Description" on page 49 . In the motherboard documentations.
82	DRAMEN~	O, L	Dram Enable. Enables Dram to the FADS memory map. See TABLE 4-10. "BCSR1 Description" on page 49 . In the motherboard documentations.
83	FCFGEN~	O, L	Flash Configuration Enable. Allows for Hard Reset Configuration to be obtained from the Flash memory provided that this option is supported by the MPC. See TABLE 4-10. "BCSR1 Description" on page 49 . In the motherboard documentations.
84	F_EN~	O, L	Flash Enable. Enables the Flash memory to the FADS memory map. See TABLE 4-10. "BCSR1 Description" on page 49 In the motherboard documentations.
85	SDRAMEN	O, H	Sdram Enable. Enables the Synchronous Dram to the FADS memory map. See TABLE 4-10. "BCSR1 Description" on page 49 . In the motherboard documentations.
86	BCSREN~	O, L	BCSR Enable. Enables the BCSR to the FADS memory map. See TABLE 4-10. "BCSR1 Description" on page 49 . In the motherboard documentations.

TABLE 5-12. PM4 Interconnect Signals

<i>Pin No.</i>	<i>Signal Name</i>	<i>Attribute</i>	<i>Description</i>
87	FETHFDE	O, X	Full Duplex Enable when auto negotiation is enable the FDE pin of the LXT970 determine full duplex advertisement capability in combination with MF4 and CFG1. See than LXT970 documentation. When auto negotiation is disable the FDE pin of the LXT970 effects full duplex and determines the value of bit 0.8 Duplex Mode. When this pin is high Full Duplex is Enable. 0.8 = 1. When this pin is low Full Duplex is Disable 0.8 = 0.
88	PCCEN~	O, L	PC- Card Enable. Enables the PC-Card to be accessed by the FADS.
89	EXTOLI0	I/O, X	External Tool Identification 0. Connected to BCSR2. See 4•11•4 "BCSR2 - Board Control / Status Register - 2" on page 51 . In the motherboard documentations.
90	SGLAMP~	O, L	Signaling Lamp. Used for misc. s/w signaling purpose. See TABLE 4-23. "BCSR4 Description" on page 57 . In the motherboard documentations.
91	EXTOLI2	I/O, X	External Tool Identification 2. Connected to BCSR2. See 4•11•4 "BCSR2 - Board Control / Status Register - 2" on page 51 . In the motherboard documentations.
92	USBVCC1	O, X	Applies only for MPC823DB. Reserved Signal for USB Power. See TABLE 4-23. "BCSR4 Description" on page 57 . In the motherboard documentations.
93	DBREV0	I, X	Daughter Board Revision Code Signal 0. The MSB of the D/B revision Code. See TABLE 4-13. "BCSR2 Description" on page 52 . In the motherboard documentations.
94	EXTOLI1	I/O, X	External Tool Identification 1. Connected to BCSR2. See 4•11•4 "BCSR2 - Board Control / Status Register - 2" on page 51 . In the motherboard documentations.
95	DBREV2	I, X	Daughter Board Revision Code Signal 2. The LMSB of the D/B revision Code. See TABLE 4-13. "BCSR2 Description" on page 52 . In the motherboard documentations.
96	EXTOLI3	I/O, X	External Tool Identification 3. Connected to BCSR2. See 4•11•4 "BCSR2 - Board Control / Status Register - 2" on page 51 . In the motherboard documentations.
97	BCSR3R1	I/O, X	Reserved signal 1 in BCSR3. See TABLE 4-19. "BCSR3 Description" on page 55 . In the motherboard documentations.
98	DBREV1	I/O, X	Daughter Board Revision Code Signal 1. See TABLE 4-13. "BCSR2 Description" on page 52 . In the motherboard documentations.
99	DBID1	I/O, X	Daughter Board ID Code 1. Part of the field which designates the type of daughter board connected. See TABLE 4-19. "BCSR3 Description" on page 55 In the motherboard documentations.
100	BCSR3R0	I/O, X	Reserved signal 0 in BCSR3. See TABLE 4-19. "BCSR3 Description" on page 55 In the motherboard documentations.

TABLE 5-12. PM4 Interconnect Signals

<i>Pin No.</i>	<i>Signal Name</i>	<i>Attribute</i>	<i>Description</i>
101	DBID3	I/O, X	Daughter Board ID Code 3. Part of the field which designates the type of daughter board connected. See TABLE 4-19. "BCSR3 Description" on page 55 in the motherboard documentations.
102	DBID0	I/O, X	Daughter Board ID Code 0. Part of the field which designates the type of daughter board connected. See TABLE 4-19. "BCSR3 Description" on page 55 in the motherboard documentations.
103	DBID5	I/O, X	Daughter Board ID Code 5. Part of the field which designates the type of daughter board connected. See TABLE 4-19. "BCSR3 Description" on page 55 in the motherboard documentations.
104	DBID2	I/O, X	Daughter Board ID Code 2. Part of the field which designates the type of daughter board connected. See TABLE 4-19. "BCSR3 Description" on page 55 in the motherboard documentations.
105	BCSR3R13	I/O, X	Reserved signal 13 in BCSR3. See TABLE 4-19. "BCSR3 Description" on page 55 in the motherboard documentations.
106	DBID4	I/O, X	Daughter Board ID Code 4. Part of the field which designates the type of daughter board connected. See TABLE 4-19. "BCSR3 Description" on page 55 in the motherboard documentations.
107	CHINS~	I/O, L	Chip In Socket. When this signal is active (low), FADS logic is noticed that the evaluated MPC8XX resides in its socket. If inactive, either the MPC is out of socket or a daughter board is not connected, in which case the FADS becomes a debug station.
108	GND		
109			
110	N.C.		
111			
112	GND		
113			
114	N.C.		
115			
116	GND		
117			
118	N.C.		
119			
120	GND		
121			
122	N.C.		
123			

TABLE 5-12. PM4 Interconnect Signals

<i>Pin No.</i>	<i>Signal Name</i>	<i>Attribute</i>	<i>Description</i>
124	GND		
125			
126	N.C.		
127			
128	GND		
129			
130	N.C.		
131			
132	GND		
133			
134	N.C.		
135			
136	GND		
137			
138	N.C.		
139			
140	GND		

5•1•5 PX1 - PX4 Hardware Expansion Connectors

These connectors are receptacle inter-board connectors made by Molex. They are identical to those exist on the MPC8XXFADS mother board. Their mechanical assembly is similar as well and is shown in [FIGURE 5-2 "Expansion Connectors Mechanical Assembly"](#) below:

FIGURE 5-2 Expansion Connectors Mechanical Assembly

In principle, the expansion connectors are identical in signals assignment to the mother boards connectors. However, there is a difference mainly between PM3 and PX3, resulting from the difference between the various members of the 8XX family. Therefore, in the following tables only the differences are documented per each connector pair - PM1 - PX1...

TABLE 5-13. PX1 - PM1 Interconnect Signals' Differences

<i>Pin No.</i>	<i>Signal Name</i>	<i>Attribute</i>	<i>Description</i>
			No Difference

TABLE 5-14. PX2 - PM2 Interconnect Signals' Differences

<i>Pin No.</i>	<i>Signal Name</i>	<i>Attribute</i>	<i>Description</i>
76	EXTCLK	O, X	External Clock. 4MHz clock generator output, the input clock to the MPC.

TABLE 5-15. PX3 - PM3 Interconnect Signals' Differences

<i>Pin No.</i>	<i>Signal Name</i>	<i>Attribute</i>	<i>Description</i>
			No Difference

TABLE 5-16. PX4 - PM4 Interconnect Signals' Differences

<i>Pin No.</i>	<i>Signal Name</i>	<i>Attribute</i>	<i>Description</i>
			No Difference

5•1•6 MPC8XXFADS's P8 - Serial Ports' Expansion Connector

P8 is a 96 pin, 900, DIN 41612 connector, which allows for convenient expansion of the MPC's serial ports. Although this connector resides on the mother board it is documented here, this, since it's signal assignment is unique per each MPC8XX. For the 860SAR this connector is the connector which through it the user will operate the 860SAR-PHY board. In the 860SAR-PHY board this connector called P13.

PRELIMINARY

Note:

The contents of TABLE 5-17. "P13 - Interconnect Signals" below, might conflict with MPC8XXFADS's schematic page 14. This since, that the schematic page is named in MPC821/860 terms. In such case, this table overrides!

TABLE 5-17. P13 - Interconnect Signals

<i>Pin No.</i>	<i>Signal Name</i>	<i>Attribute</i>	<i>Description</i>
A1	ETHRX	I/O	Ethernet port receive data. See PM3(1)
A2	ETHTX	I/O	Ethernet Port transmit data. See PM3(5,11,42)
A3	IRDRXD	I/O	IrDA port receive data. See PM3(9).
A4	IRDTXD	I/O	IrDA port transmit data. See PM3(5,11,42)
A5	LD4	I/O	Also VD3. See PM3(117)
A6	LD3	I/O	Also VD2. See PM3(116)
A7	LD2	I/O	Also VD1. See PM3(115)
A8	LD1	I/O	Also VD0. See PM3(114)
A9	ETHTCK	I/O	Ethernet port transmit clock. See PM3(27).
A10	ETHRCK	I/O	Ethernet port receive clock. See PM3(29)
A11	N.C.	-	
A12	PA4	I/O	BRGCLK2/TOUT2/CLK4/PA[4]. See PM3(60)
A13	N.C.	-	
A14	L1RCLKB	I/O	See PM3(74).
A15	N.C.	-	
A16			
A17	VCC	-	
A18	PA9	I/O	See PM3(15,21).
A19	L1RXDB	I/O	See PM3(17).
A20	PA9	I/O	See PM3(21).
A21	L1RXDA	I/O	See PM3(23)
A22	GND	-	
A23	GND	-	
A24	IRQ7~	I, L	See PM2(130)
A25	FRZ	I/O	See PM2(24).
A26	ETHEN~	O	See PM3(82)
A27	N.C.	-	

TABLE 5-17. P13 - Interconnect Signals

<i>Pin No.</i>	<i>Signal Name</i>	<i>Attribute</i>	<i>Description</i>
A28	IRQ2~	I, L	RSV/IRQ2~. See PM2(26).
A29	IRQ1~	I, L	See PM2(126).
A30	NMI~	I, L	See PM2(134).
A31	RS_EN1~	O,L	See PM3(96).
A32	GND	-	
B1	LCD_A	I/O	LCD_A/PB31. See PM3(33).
B2	PB30	I/O	See PM3(35).
B3	PB29	I/O	See PM3(37).
B4	PB28	I/O	See PM3(51).
B5	I2CDAT	I/O	PB27/I2CDAT. See PM3(50).
B6	I2CCLK	I/O	PB26/I2CCLK. See PM3(54).
B7	RSTXD1	I/O	See PM3(38).
B8	RSRXD1	I/O	See PM3(39).
B9	RSDTR1~	I/O	See PM3(40).
B10	RSDTR2~	I/O	See PM3(44).
B11	TXD2.	I/O	See PM3(5,11,42).
B12	RSRXD2	I/O	See PM3(43)
B13	E_TENA	I/O	See PM3(77).
B14	LCD_B	I/O	PB19/LCD_B. See PM3(76).
B15	LCD_C	I/O	PB17/LCD_C. See PM3(75).
B16	PB16	I/O	See PM3(93).
B17	N.C.	-	
B18	N.C.	-	
B19	GND	-	
B20	BINPAK~	I/O	See PM3(34).
B21	PC14	I/O	See PM3(45).
B22	PC13	I/O	See PM3(26).
B23	PC12	I/O	See PM3(53).
B24	E_CLSN	I/O	See PM3(61).
B25	E_RENA	I/O	See PM3(62).
B26	USBRXP	I/O	PC11/USBRXP. See PM3(8).
B27	USBRXN	I/O	PC10/USBRXN. See PM3(14).
B28	USBTXP	I/O	PC7/USBTXP. See PM3(20).

TABLE 5-17. P13 - Interconnect Signals

<i>Pin No.</i>	<i>Signal Name</i>	<i>Attribute</i>	<i>Description</i>
B29	L1RSYNCB	I/O	See PM3(100).
B30	PC5	I/O	See PM3(99).
B31	L1RSYNCA	I/O	See PM3(98).
B32	GND	-	
C1	VCC		
C2			
C3			
C4			
C5			
C6	RS_EN2~	O, L	See PM3(102).
C7	GND		
C8			
C9			
C10			
C11			
C12			
C13			
C14			
C15	VD7	I/O	See PM3(121).
C16	VD6	I/O	See PM3(120).
C17	VD5	I/O	See PM3(119).
C18	VD4	I/O	See PM3(118).
C19	FIELD	I/O	See PM3(113).
C20	BLANK~	I/O	See PM3(110).
C21	VCC	-	
C22	HRESET~	I/O, L	See PM2(84).
C23	SRESET~	I/O, L	See PM2(80).
C24	N.C.	-	Not Connected
C25	VCC	-	
C26	VDOCLK	I/O	See PM3(103)
C27	VPPIN	I/O	+12V input for PCMCIA flash programming. Parallel to P7 of the MPC8XXFADS.
C28			
C29	GND	-	

TABLE 5-17. P13 - Interconnect Signals

<i>Pin No.</i>	<i>Signal Name</i>	<i>Attribute</i>	<i>Description</i>
C30	HSYNC	I/O	See PM3(106).
C31	GND	-	
C32	VSYNC	I/O	See PM3(107).

PRELIMINARY

5•2 MPC860TFADSDB Part List

In this section the MPC860TFADSDB bill of material is listed according to their reference designation.

TABLE 5-18. MPC860TFADSDB Part List

<i>Reference Designation</i>	<i>Part Description</i>	<i>Manufacturer</i>	<i>Part #</i>
C5 C6 C7 C8 C9 C10 C11 C12 C14 C15 C16 C17 C19 C20 C22 C23 C24 C25 C28 C29 C32 C37 C38 C39 C40 C43 C47 C48 C49 C52 C53	Capacitor 0.1 μ F,16V, 10%, SMD 0603, Ceramic	AVX	0603YC104KAT20
C2 C3 C4 C31 C33 C34 C36 C51	Capacitor 10 μ F, 20V, 10%, SMD Size C, Tantalum	SIEMENS	B45196-H4475-K20
C13	Capacitor 100 μ F, 10V, 10%, SMD Size D, Tantalum	SIEMENS	B45196-H2107-K10
C30 C35	Capacitor 1 μ F, 25V, 10%, SMD Size A, Tantalum	SIEMENS	B45196-H5105-K10
C18 C21	Capacitor 10pF, 50V 10%, COG, SMD 1206, Ceramic	AVX	AV12065A100KAT00J
C26	Capacitor 5000pF, 50V, 10%, SMD 1206, Ceramic	AVX	AV12065C 502K A700J
C27	Capacitor 0.68 μ F, 20V, 10%, SMD, Size A, Tantalum	SIEMENS	B45196-E4684-K9
C1 C44 C45 C46	Cap 0.01 μ F 50V 10% NPO 1206	VTRAMON	VJ1210A103KXAT
C41 C42	Cap 18pF 50V COG 1206 SMD CER T/R	AVX	12065A180JAT
C50	Cap 1nF2KV X7R 1210 SMD CER CAP T/R	AVX	1210B102K202NT
D1	Diode SMD	Motorola	LL4004G
DS1	Dip Switch	BOURNS	90HBW08S
H1 H2 H3	Gnd Bridge, Gold Plated	PRECIDIP	999-11-112-10
J1 J2 J3	Jumper Header, 3 Pole with Fabricated Jumper		
J4 J5	Jumper, Soldered.		
L1	Inductor 8.2 mHy	BOURNS	PT12133
L2 L3 L4 L5 L6 L7	Ferrite bid SMD	FAIR-RITE	2743021447
LD1 LD2 LD3 LD4 LD5 LD6 LD7	Led Green SMD	SIEMENS	LG-T679-C0
P1 P2 P4 P5 P6 P8 P9	Connector 38 pin, Receptacle MICTOR.	AMP	2-767004-2
P3	RJ_45 8PIN CONNECTOR	KCC	90015-8P8C
P7	Connector Header, 40 pin, Dual In-line, SMD	SAMTEC	TSM-115-04-S-DV

TABLE 5-18. MPC860TFADSDB Part List

<i>Reference Designation</i>	<i>Part Description</i>	<i>Manufacturer</i>	<i>Part #</i>
PM1 PM2 PM3 PM4	Connector Inter-board, 7mm Height, 140 pin, Plug, SMD	MOLEX	53481-1409
PX1 PX2 PX3 PX4	Connector Inter-board 140 pin, Receptacle, SMD	MOLEX	52760-1409
R11	Resistor 124 K Ω , 5%, SMD 1206, 1/8W	RODERSTEIN	D25 124K FCS
R4 R5 R6 R42 R43	Resistor 75 Ω , 5%, SMD 1206, 1/8W	DRALORIC	CR1206 100 75RJ
R13	Resistor 4.7 K Ω , 5%, SMD 1206, 1/8W	BOURNS	CR1206 JW 472E
R7	Resistor 47 K Ω , 1%, SMD 1206, 1/8W	KYOCERA	CR32 473JT
R8	Resistor 200 K Ω , 5%, SMD 1206, 1/8W	RODERSTEIN	D25 200K FCS
R9	Resistor 20 M Ω , 5%, SMD 1206, 1/8W	RODERSTEIN	D25 020MJS
R10 R12 R15 R17 R18 R19 R20 R28 R29	Resistor 0 Ω , SMD 1206, 1/8W	TYOHM	RMC 1206 0E 1%
R14 R16 (Not populated)	Resistor 0 Ω , SMD 1206, 1/8W	TYOHM	RMC 1206 0E 1%
R34	Resistor 143 Ω , 5%, SMD 1206, 1/8W	RODERSTEIN	D25 143R FCS
R33	Resistor 243 Ω , 1%, SMD 1206, 1/8W	RODERSTEIN	D25 243R FCS
R1 R21 R22 R23 R24 R25	Resistor 330 Ω , 5%, SMD 1206, 1/8W		1002G43300J
R2 R3 R36 R37	Resistor 191 Ω , 1%, SMD 1206, 1/8W	DALE	
R26	Resistor 22.1K Ω , 1%, SMD 1206, 1/8W	DRALORIK	D25-22K1SCS
R30	Resistor 100 Ω , 1%, SMD 1206, 1/8W	DRALORIK	D25-100RFCS
R31 R38 R39 R40 R41 R46 R47 R48	Resistor 50 Ω , 1%, SMD 1206, 1/8W		
R32 R 35 R44 R45	Resistor 69.8 Ω , 1%, SMD 1206, 1/8W	DALE	
RN1 RN2 RN3	Resistor Network 75 Ω , 5%, 8 resistors, 16 pin.	BOURNS	4816P 001 750J
RN5 RN6	Resistor Network 1K Ω , 5%, 8 resistors, 16 pin.	BOURNS	D OMC 1401 472
RN4	Resistor Network 4.7K, 5%, 8 resistors, 14 pin.	DALE	SOMC1603-102GTR

TABLE 5-18. MPC860TFADSDB Part List

<i>Reference Designation</i>	<i>Part Description</i>	<i>Manufacturer</i>	<i>Part #</i>
T1S	Transistor TMOS, Dual, 3A	Motorola	MMDF3N03HD
U1	4 MHz Clock generator. 3.3V, CMOS levels.	MGR-Tech	MH14FAD 3.3V 4.00MHz
U2	MPC860T, 19 X 19, 357 pin BGA.	Motorola	MPC860 or MPC860SAR or MPC860T
U3	OPTICAL TRANCEIVER This device is not mounted on the board. if the user wants to use fiber optic he should populate it.	HP	HFBR-5103 or HFBR-5105
U4	F-ETHERNET TRANCEIVER	LENEZONE	LXT970
U5	LAN Magnetics	HALO	TG-223506
U6	Quad Low Voltage CMOS AND Gate.	Motorola	74LCX08D
U7	Voltage level detector. Range 1.795V to 2.005V. O.D. output.	Seiko	S-8051HN-CD-X
U8	Variable Output Voltage regulator.	Motorola	LM317MDT
Y1	25Mhz CRYSTAL	CTS	CTX093
Y2	Crystal resonator, 32.768 KHz, Frequency tolerance ± 30 ppm, Drive-level - 10 μ W Max, Shunt capacitance - 2pF Max., Load capacitance - 12.5pF Max., Equivalent Series Resistance - 35 K Ω Max.	RALTRON	RSM-200-32.768 KHZ
	14 pin PC Socket	PD	110-93-314
	361 pin 19 X 19 BGA ZIF Socket	ENPLUS	BGA357(441)-1.27-01

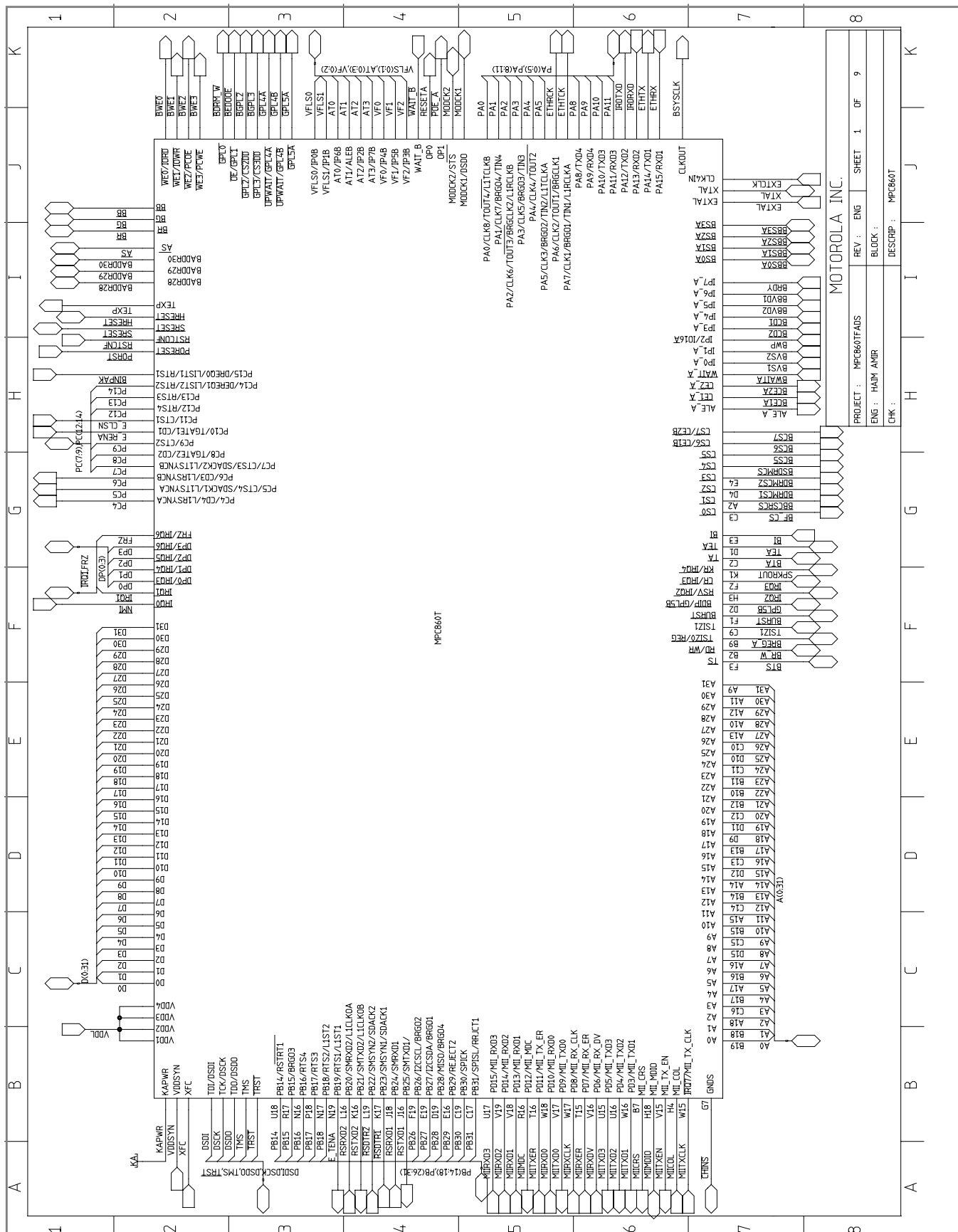



MOTOROLA INC.			
PROJECT :	MPC860TFAISUB	REV :	ENG
ENG :	HAIM AMR	BLOCK :	FAST ETHERNET TRANSIVER
CHK :		DESCRIP :	
		SHEET :	2
		OF :	9



PROJECT :	MPC8601FADSIOB	REV :	ENG	SHEET	3	OF	9
ENG :	HAIM AMIR	BLOCK :	COMM., POWER & CLOCK				
CHK :		DESCRIP :					

MOTOROLA INC.

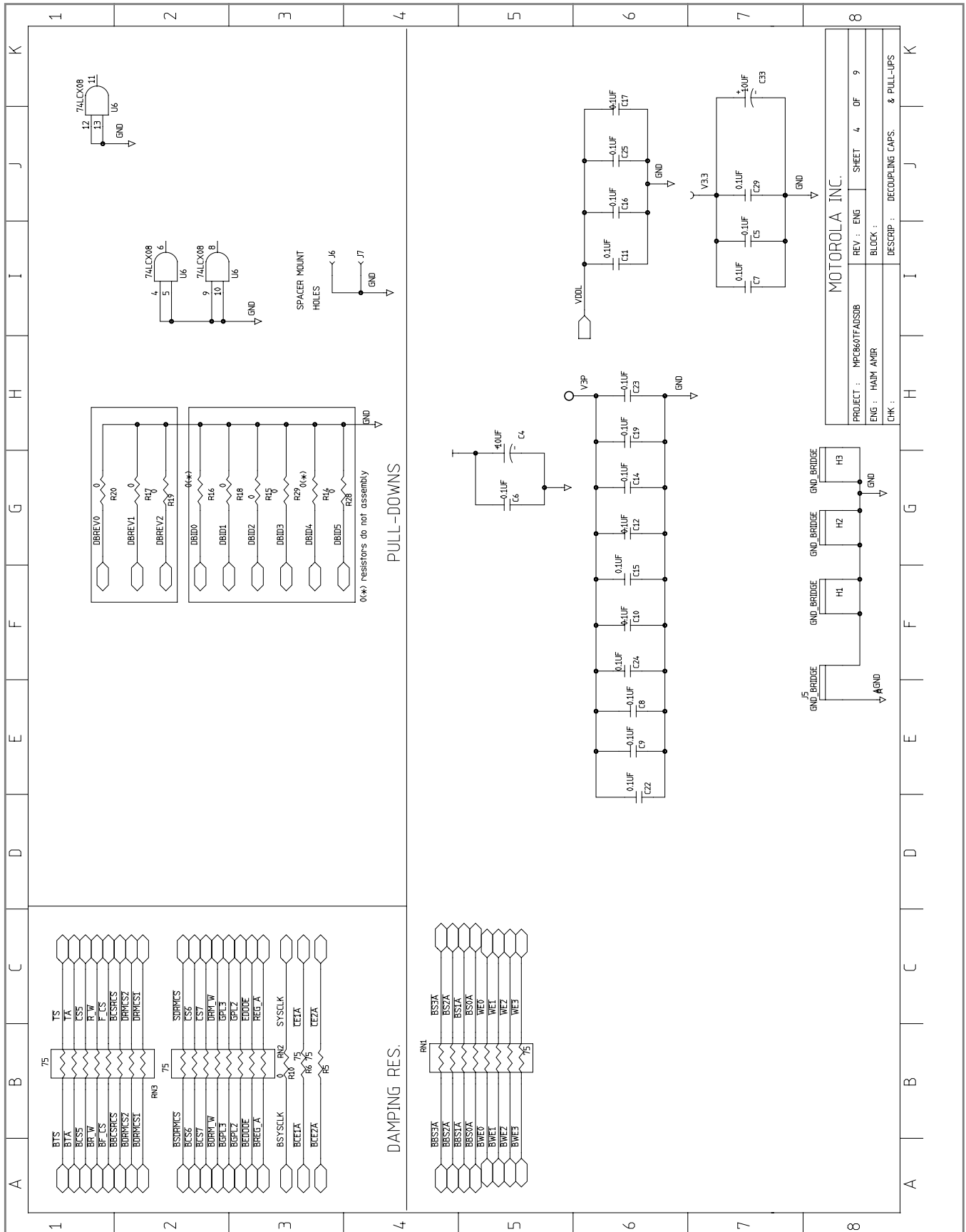

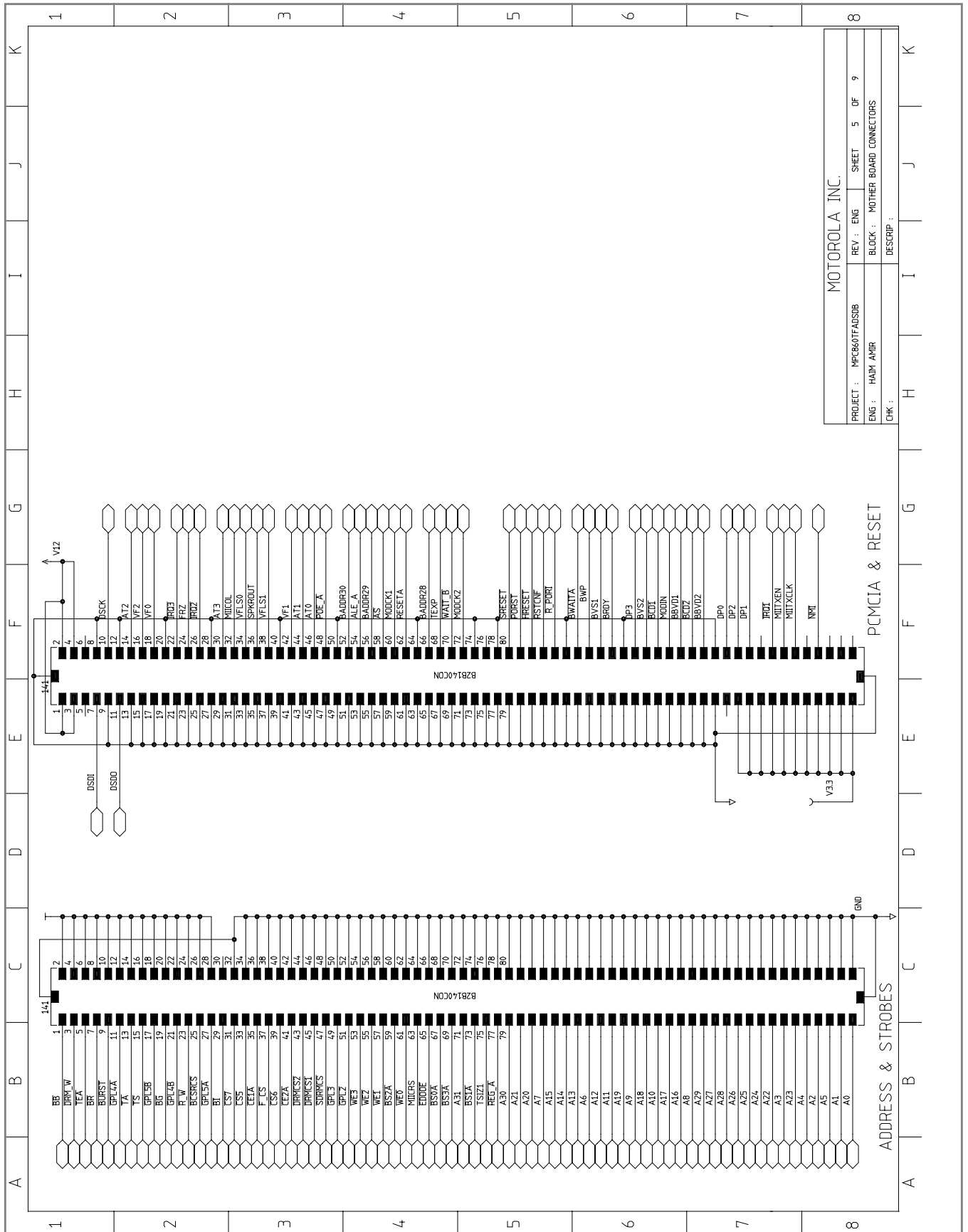

PROJECT :	MPC8601FADS0B	REV :	ENG	SHEET	5	OF	9
ENG :	HAIM AMR	BLOCK :	MOTHER BOARD CONNECTORS				
CHK :		DESCRIP :					

MOTOROLA INC.

PCMCIA & RESET

ADDRESS & STROBES



MOTOROLA INC.			
PROJECT :	MPC8607FAUS	REV. :	PENG
ENG :	HAIM AMR	BLOCK :	DAUGHTER BOARD CONNECTOR
CHK :		DESCRIP :	
		SHEET :	6 OF 9

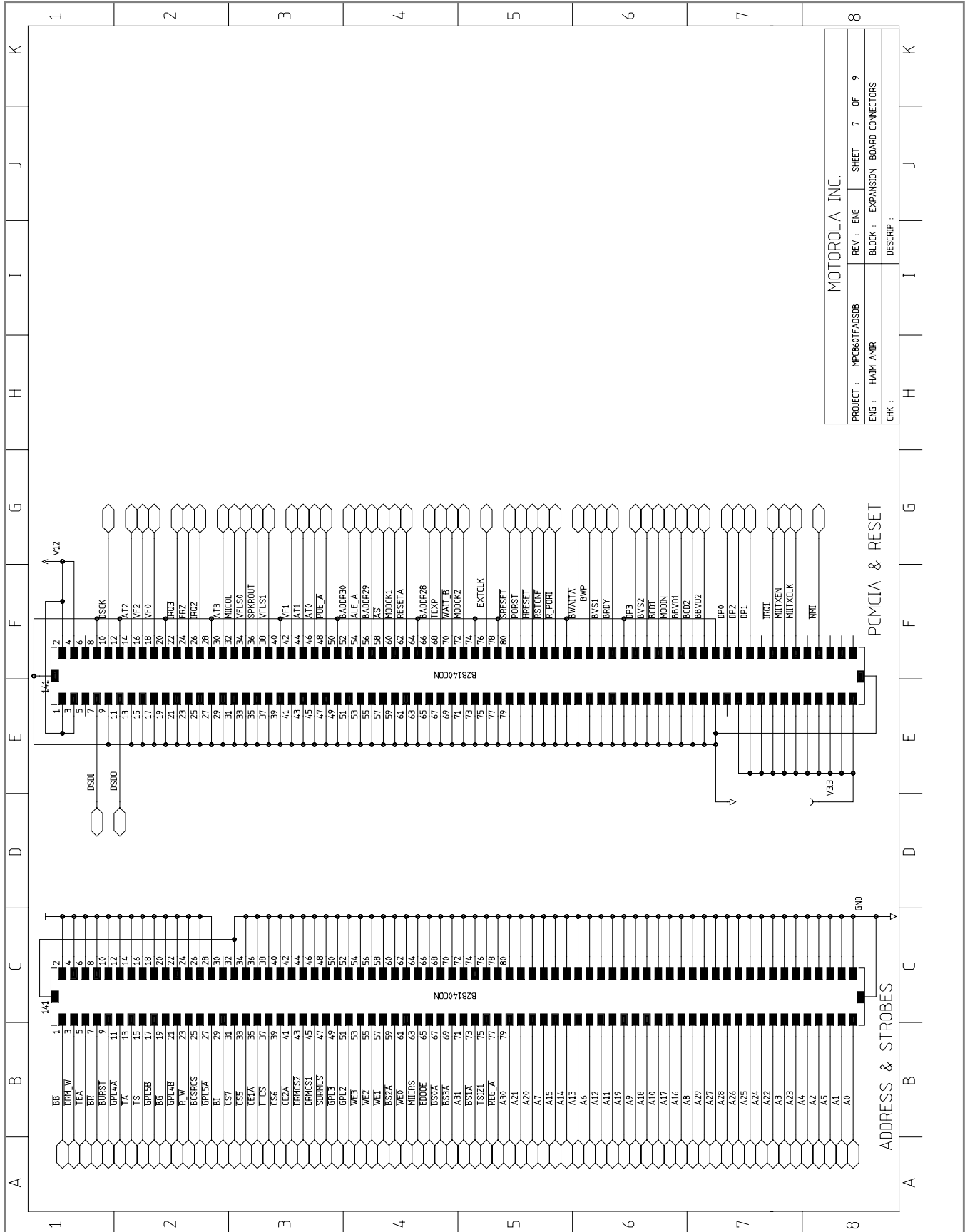



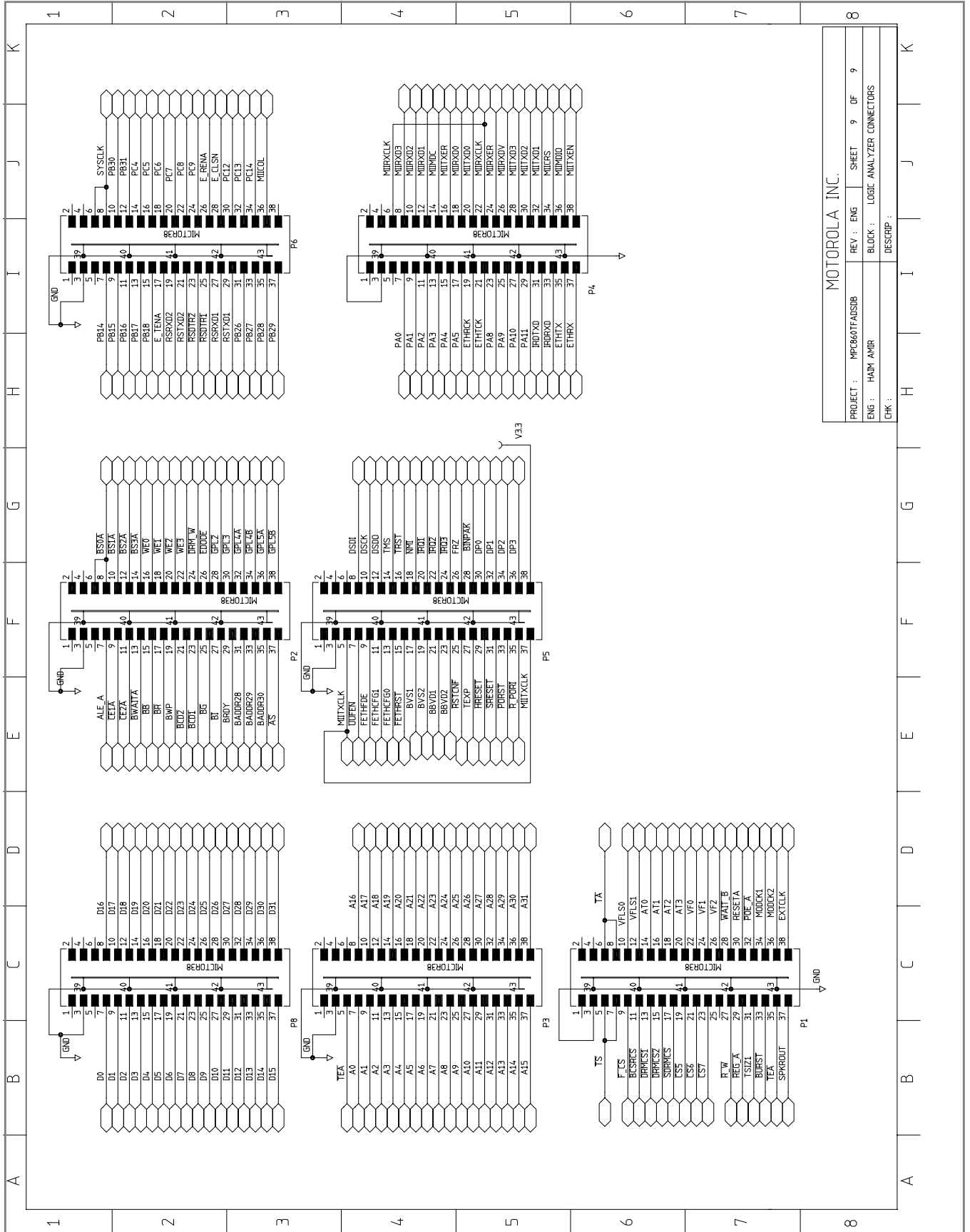

MOTOROLA INC.			
PROJECT : MPC8601T ADSDB	REV : ENG	SHEET 9 OF 9	
ENG : HADM AMR	BLOCK : LOGIC ANALYZER CONNECTORS		
CHK :	DESCRIP :		



Компания «ЭлектроПласт» предлагает заключение долгосрочных отношений при поставках импортных электронных компонентов на взаимовыгодных условиях!

Наши преимущества:

- Оперативные поставки широкого спектра электронных компонентов отечественного и импортного производства напрямую от производителей и с крупнейших мировых складов;
- Поставка более 17-ти миллионов наименований электронных компонентов;
- Поставка сложных, дефицитных, либо снятых с производства позиций;
- Оперативные сроки поставки под заказ (от 5 рабочих дней);
- Экспресс доставка в любую точку России;
- Техническая поддержка проекта, помощь в подборе аналогов, поставка прототипов;
- Система менеджмента качества сертифицирована по Международному стандарту ISO 9001;
- Лицензия ФСБ на осуществление работ с использованием сведений, составляющих государственную тайну;
- Поставка специализированных компонентов (Xilinx, Altera, Analog Devices, Intersil, Interpoint, Microsemi, Aeroflex, Peregrine, Syfer, Eurofarad, Texas Instrument, Miteq, Cobham, E2V, MA-COM, Hittite, Mini-Circuits, General Dynamics и др.);

Помимо этого, одним из направлений компании «ЭлектроПласт» является направление «Источники питания». Мы предлагаем Вам помощь Конструкторского отдела:

- Подбор оптимального решения, техническое обоснование при выборе компонента;
- Подбор аналогов;
- Консультации по применению компонента;
- Поставка образцов и прототипов;
- Техническая поддержка проекта;
- Защита от снятия компонента с производства.



Как с нами связаться

Телефон: 8 (812) 309 58 32 (многоканальный)

Факс: 8 (812) 320-02-42

Электронная почта: org@eplast1.ru

Адрес: 198099, г. Санкт-Петербург, ул. Калинина, дом 2, корпус 4, литера А.