

\*G Denotes RoHS Compliant, Pb free Terminal Finish

## RF & MICROWAVE DISCRETE LOW POWER TRANSISTORS

### Features

- Low Noise - 2.5 dB @ 500 MHz
- Gain at Optimum Noise Figure = 15.5 dB @ 500 MHz
- Ft<sub>au</sub> - 5.0 GHz @ 10v, 75mA
- Cost Effective MacroX Package

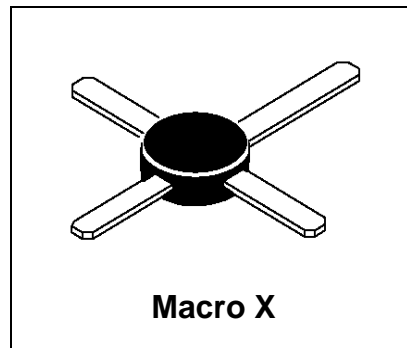

**DESCRIPTION:** Designed for high current, low power, low noise, amplifiers up to 1.0 GHz.

### ABSOLUTE MAXIMUM RATINGS (T<sub>case</sub> = 25°C)

Symbol	Parameter	MRF581	MRF581A	Unit
V <sub>CEO</sub>	Collector-Emitter Voltage	18	15	Vdc
V <sub>CBO</sub>	Collector-Base Voltage	30		Vdc
V <sub>EBO</sub>	Emitter-Base Voltage	2.5		Vdc
I <sub>C</sub>	Collector Current	200		mA

### Thermal Data

P <sub>D</sub>	Total Device Dissipation @ TC = 50°C Derate above 50°C	2.5 25	Watts mW/ °C
P <sub>D</sub>	Total Device Dissipation @ TC = 25°C Derate above 25°C	1.25 10	Watts mW/ °C
T <sub>stg</sub>	Storage Junction Temperature Range	-65 to +150	°C
T <sub>Jmax</sub>	Maximum Junction Temperature	150	°C

Revision A- December 2008

## ELECTRICAL SPECIFICATIONS (Tcase = 25°C)

### STATIC (off)

Symbol	Test Conditions		Value			Unit
			Min.	Typ.	Max.	
BVCEO	Collector-Emitter Breakdown Voltage (IC = 5.0 mAdc, IB = 0)	MRF581 MRF581A	18 15	-	-	Vdc
BVCBO	Collector-Base Breakdown Voltage (IC = 1.0 mAdc, IE = 0)		30	-	-	Vdc
BVEBO	Emitter-Base Breakdown Voltage (IE = 0.1 mAdc, IC = 0)		2.5	-	-	Vdc
ICBO	Collector Cutoff Current (VCB = 15 Vdc, VBE = 0 Vdc)		-	-	0.1	mA
IEBO	Emitter Cutoff Current (Vbe = 2.5 Vdc)		-	-	0.1	mA

### (on)

HFE	DC Current Gain (IC = 50 mAdc, VCE = 5.0 Vdc)	MRF581 MRF581A	50 90	-	200 250	-
-----	--	-------------------	----------	---	------------	---

### DYNAMIC

Symbol	Test Conditions		Value			Unit
			Min.	Typ.	Max.	
COB	Output Capacitance (VCB = 10 Vdc, IE = 0, f = 1.0 MHz)		-	2.0	3.0	pF
Ftau	Current-Gain Bandwidth Product (IC = 75 mAdc, VCE = 10 Vdc, f = 1.0 GHz)		-	5.0	-	GHz

**FUNCTIONAL**

Symbol	Test Conditions	Value			Unit
		Min.	Typ.	Max.	
NF	Noise Figure (50ohms) (IC = 50 mAdc, VCE = 10 Vdc, f = 0.5 GHz)	-	3.0	3.5	dB
$G_{NF}$	Power Gain @ NFmin (IC = 50 mAdc, VCE = 10 Vdc, f = 0.5 GHz)	13	15.5		dB
$G_{U\max}$	Maximum Unilateral Gain (1) IC = 50 mAdc, VCE = 10 Vdc, f = 500 MHz	-	17.8	-	dB
MSG	Maximum Stable Gain IC = 50 mAdc, VCE = 10 Vdc, f = 500 MHz	-	20	-	dB
$ S_{21} ^2$	Insertion Gain IC = 50 mAdc, VCE = 10 Vdc, f = 500 MHz	14	15	-	dB

Table 1. Common Emitter S-Parameters, @ VCE = 10 V, IC = 50 mA

f (MHz)	S11		S21		S12		S22	
	S11	$\angle \phi$	S21	$\angle \phi$	S12	$\angle \phi$	S22	$\angle \phi$
100	.610	-137	23.8	116	.026	46	.522	-78
200	.659	-161	13.2	98	.033	47	.351	-106
300	.671	-171	9.0	89	.040	51	.304	-120
400	.675	-178	6.8	83	.047	55	.292	-128
500	.677	176	5.5	77	.055	58	.293	-132
600	.678	172	4.6	72	.064	61	.299	-134
700	.677	168	4.0	68	.073	62	.306	-135
800	.679	184	3.5	64	.082	63	.314	-136
900	.678	160	3.1	60	.092	64	.322	-138
1000	.682	156	2.8	56	.102	65	.311	-139

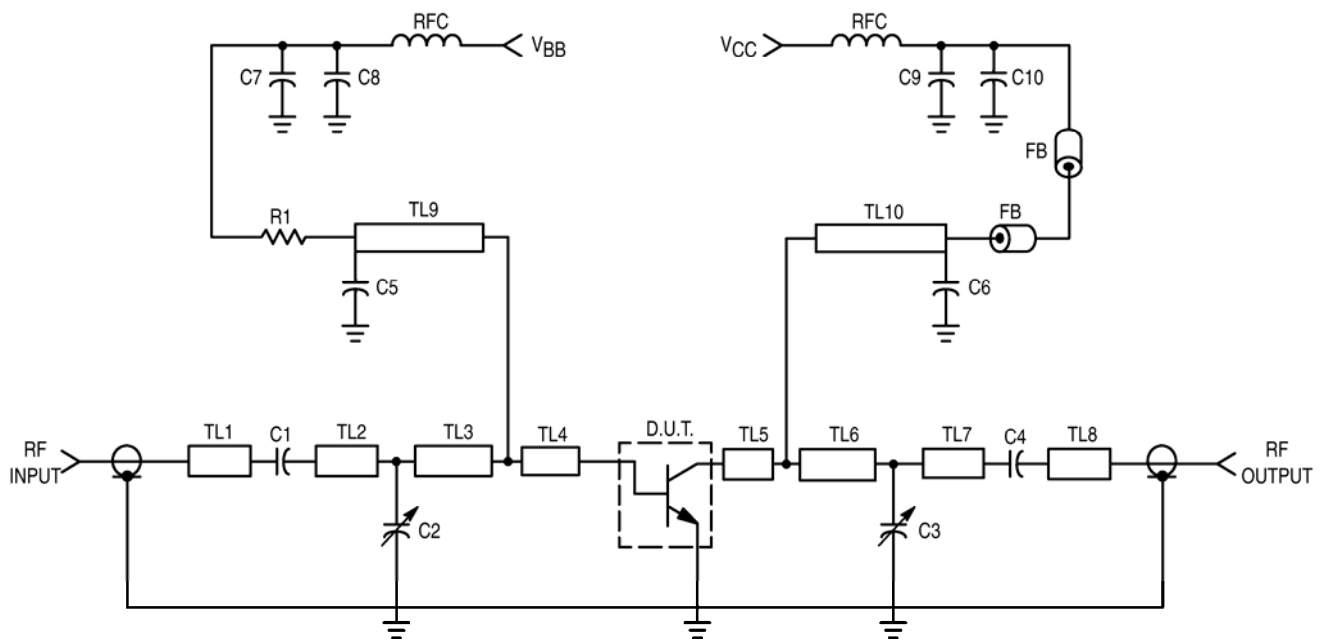

C1, C4, C5, C6, C8, C9 — 1000 pF, Chip Capacitor  
 C7, C10 — 10  $\mu$ F, Tantalum Capacitor  
 RFC — VK-200, Ferroxcube  
 TL1, TL7, TL8 — Microstrip 0.162, x 0.600,  
 TL3 — Microstrip 0.162, x 0.800,  
 TL5 — Microstrip 0.120, x 0.440,  
 TL9, TL10 — Microstrip 0.025, x 4.250,  
 Board Material — 0.0625, Thick Glass Teflon  $\epsilon r = 2.55$

C2, C3 — 1.0–10 pF, Johanson Capacitor  
 R1 — 1.0 k $\Omega$  Res.  
 FB — Ferrite Bead, Ferroxcube, 56–590–65/3B  
 TL2 — Microstrip 0.162, x 1.000,  
 TL4 — Microstrip 0.162, x 0.440,  
 TL6 — Microstrip 0.120, x 1.160,

**Figure 1. Minimum Noise Figure and Gain @ Minimum Noise Figure.**

**RF Low Power PA, LNA, and General Purpose Discrete Selector Guide**

Package	Device	Type	GPE Freq (MHz)	Pout (watts)	GPE (dB)	Efficiency (%)	GPE VCC	BVCEO	IC max (mA)
SO-8	MRF4427, R2	NPN	175	0.15	18	60	12	20	400
TO-39	2N4427	NPN	175	1	10	50	12	20	400
POWER MACRO	MRF553	NPN	175	1.5	11.5	60	12.5	16	500
POWER MACRO	MRF553T	NPN	175	1.5	11.5	50	12.5	16	500
TO-39	MRF607	NPN	175	1.75	11.5	50	12.5	16	330
TO-39	2N6255	NPN	175	3	7.8	50	12.5	18	1000
TO-72	2N5179	NPN	200		20	6	12	50	
MACRO X	MRF559	NPN	512	0.5	10	65	7.5	16	150
MACRO X	MRF559	NPN	512	0.5	13	60	12.5	16	150
TO-39	2N3866A	NPN	400	1	10	45	28	30	400
SO-8	MRF3866, R1, R2	NPN	400	1	10	45	28	30	400
POWER MACRO	MRF555	NPN	470	1.5	11	50	12.5	16	400
POWER MACRO	MRF555T	NPN	470	1.5	11	50	12.5	16	400
MACRO X	MRF559	NPN	870	0.5	6.5	70	7.5	16	150
MACRO X	MRF559	NPN	870	0.5	9.5	65	12.5	16	150
SO-8	MRF8372, R1, R2	NPN	870	0.75	8	55	12.5	16	200
POWER MACRO	MRF557	NPN	870	1.5	8	55	12.5	16	400
POWER MACRO	MRF557T	NPN	870	1.5	8	55	12.5	16	400

RF (Low Power PA / General Purpose) Selection Guide

Package	Device	Type	Freq (MHz)	NF (dB)	NF IC (mA)	NF VCE	GN (dB)	Gu Max (dB)	Ftaw (MHz)	Ccb(pF)	BVCEO	IC max (mA)
TO-39	2N5109	NPN	200	3	10	15		12	1200	3.5	20	400
TO-39	MRF5943C	NPN	200	3.4	30	15		11.4	1000		30	400
SO-8	MRF5943, R1, R2	NPN	200	3.4	30	15		15	1300		30	400
TO-72	2N5179	NPN	200	4.5	1.5	6		17	900	1	12	50
TO-72	2N2857	NPN	300	5.5	50	6		13	1600	1	15	40
TO-39	MRF517	NPN	300	7.5	50	15		5.5	4600	3	25	150
TO-72	MRF904	NPN	450	1.5	5	6		11	4000	1	15	30
TO-39	2N6304	NPN	450	5	2	5		14	1400	1	15	50
MACRO T	BFR91	NPN	500	1.9	2	5	11	16.5	5000	1	12	35
MACRO T	BFR96	NPN	500	2	10	10		14.5	500	2.6	15	100
SO-8	MRF5812, R1, R2	NPN	500	2	50	10	15.5	17.8	5000		15	200
MACRO X	MRF581A	NPN	500	2	50	10	14	15	5000		15	200
Macro	BFR90	NPN	500	2.4	2	10	15	18	5000	1	15	30
TO-72	BFY90	NPN	500	2.5	2	5		20	1300		15	50
TO-72	MRF914	NPN	500	2.5	5	10		15	4500		12	40
MACRO X	MRF581	NPN	500	2.5	50	10	15	17.8	5000		16	200
TO-39	MRF586	NPN	500	3	90	15	11	14.5	4500	2.2	17	200
MACRO X	MRF951	NPN	1000	1.3	5	6	14	17	8000	0.45	10	100
MACRO X	MRF571	NPN	1000	1.5	10	6	10		8000	1	10	70
MACRO T	BFR91	NPN	1000	2.5	2	5	8	11	5000	1	12	35
MACRO T	BFR90	NPN	1000	3	2	10	10	12.5	5000	1	15	30
TO-39	MRF545	PNP						14	1400	2	70	400
TO-39	MRF544	NPN						13.5	1500		70	400

RF (LNA / General Purpose) Selection Guide

**Low Cost RF Plastic Package Options**

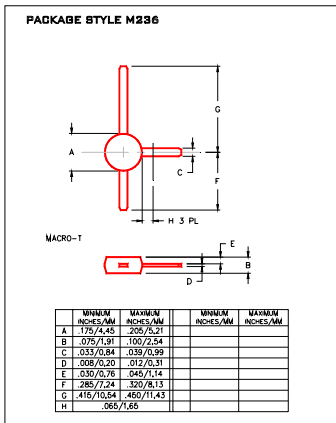

Macro T

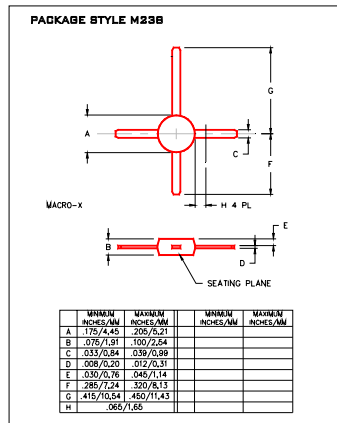

Macro X

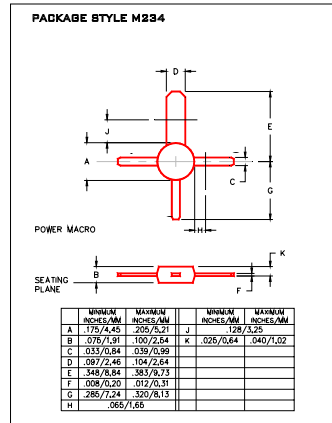

Power

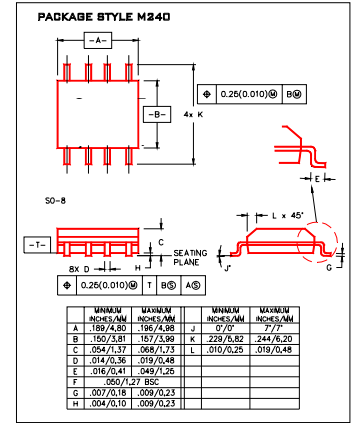

SO-8

### PACKAGE STYLE M238

- PIN 1. COLLECTOR  
 2. EMITTER  
 3. BASE  
 4. EMITTER

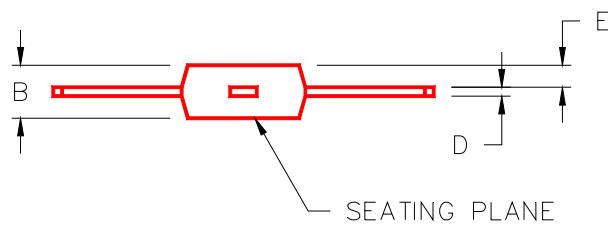
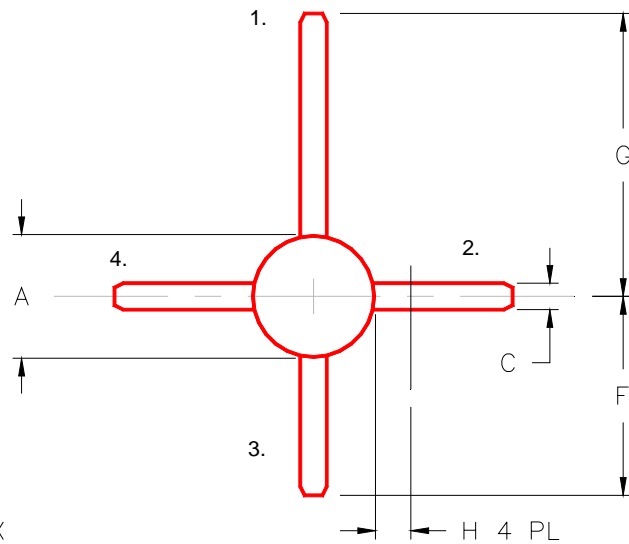

	MINIMUM INCHES/MM	MAXIMUM INCHES/MM		MINIMUM INCHES/MM	MAXIMUM INCHES/MM
A	.175/4,45	.205/5,21			
B	.075/1,91	.100/2,54			
C	.033/0,84	.039/0,99			
D	.008/0,20	.012/0,31			
E	.030/0,76	.045/1,14			
F	.285/7,24	.320/8,13			
G	.415/10,54	.450/11,43			
H	.065/1,65				



Компания «ЭлектроПласт» предлагает заключение долгосрочных отношений при поставках импортных электронных компонентов на взаимовыгодных условиях!

Наши преимущества:

- Оперативные поставки широкого спектра электронных компонентов отечественного и импортного производства напрямую от производителей и с крупнейших мировых складов;
- Поставка более 17-ти миллионов наименований электронных компонентов;
- Поставка сложных, дефицитных, либо снятых с производства позиций;
- Оперативные сроки поставки под заказ (от 5 рабочих дней);
- Экспресс доставка в любую точку России;
- Техническая поддержка проекта, помощь в подборе аналогов, поставка прототипов;
- Система менеджмента качества сертифицирована по Международному стандарту ISO 9001;
- Лицензия ФСБ на осуществление работ с использованием сведений, составляющих государственную тайну;
- Поставка специализированных компонентов (Xilinx, Altera, Analog Devices, Intersil, Interpoint, Microsemi, Aeroflex, Peregrine, Syfer, Eurofarad, Texas Instrument, Miteq, Cobham, E2V, MA-COM, Hittite, Mini-Circuits, General Dynamics и др.);

Помимо этого, одним из направлений компании «ЭлектроПласт» является направление «Источники питания». Мы предлагаем Вам помощь Конструкторского отдела:

- Подбор оптимального решения, техническое обоснование при выборе компонента;
- Подбор аналогов;
- Консультации по применению компонента;
- Поставка образцов и прототипов;
- Техническая поддержка проекта;
- Защита от снятия компонента с производства.



#### Как с нами связаться

**Телефон:** 8 (812) 309 58 32 (многоканальный)

**Факс:** 8 (812) 320-02-42

**Электронная почта:** [org@eplast1.ru](mailto:org@eplast1.ru)

**Адрес:** 198099, г. Санкт-Петербург, ул. Калинина, дом 2, корпус 4, литера А.