

# 1MHz to 6GHz Wideband High Linearity Active Mixer

## FEATURES

- Input Frequency Range to 6GHz
- 50Ω Matched Input from 30MHz to >3GHz
- Capable of Up- or Down-Conversion
- OIP3: 27dBm at  $f_{OUT} = 1575\text{MHz}$
- 1.5dB Conversion Gain
- Noise Figure: 11.6dB at  $f_{OUT} = 1575\text{MHz}$
- High Input P1dB: 11dBm at 5V
- 5V or 3.3V Supply at 105mA
- Shutdown Control
- LO Input Impedance Always Matched
- 0dBm LO Drive Level
- On-Chip Temperature Monitor
- -40°C to 105°C Operation ( $T_C$ )
- 16-Lead (4mm × 4mm) QFN Package

## APPLICATIONS

- Wideband Receivers/Transmitters
- Cable Downlink Infrastructure
- HF/VHF/UHF Mixer
- Wireless Infrastructure

## DESCRIPTION

The **LTC<sup>®</sup>5510** is a high linearity mixer optimized for applications requiring very wide input bandwidth, low distortion, and low LO leakage. The chip includes a double-balanced active mixer with an input buffer and a high speed LO amplifier. The input is optimized for use with 1:1 transmission-line baluns, allowing very wideband impedance matching. The mixer can be used for both up- and down-conversion and can be used in wideband systems.

The LO can be driven differentially or single-ended and requires only 0dBm of LO power to achieve excellent distortion and noise performance, while also reducing external drive circuit requirements. The LTC5510 offers low LO leakage, greatly reducing the need for output filtering to meet LO suppression requirements.

The LTC5510 is optimized for 5V but can also be used with a 3.3V supply with slightly reduced performance. The shutdown function allows the part to be disabled for further power savings.

LT, LT, LTC, LTM, Linear Technology and the Linear logo are registered trademarks of Linear Technology Corporation. All other trademarks are the property of their respective owners.

## TYPICAL APPLICATION

30MHz to 4GHz Up/Down Mixer for Wideband Receiver

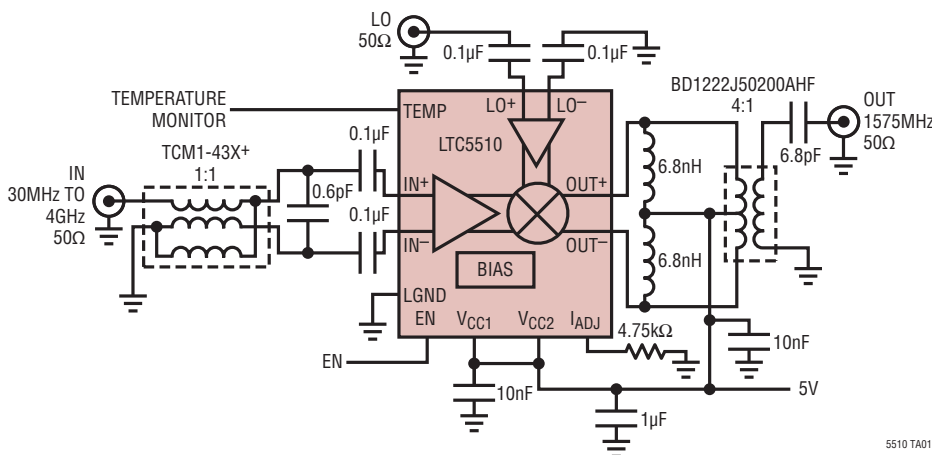

Conversion Gain, IIP3 and NF vs Input Frequency

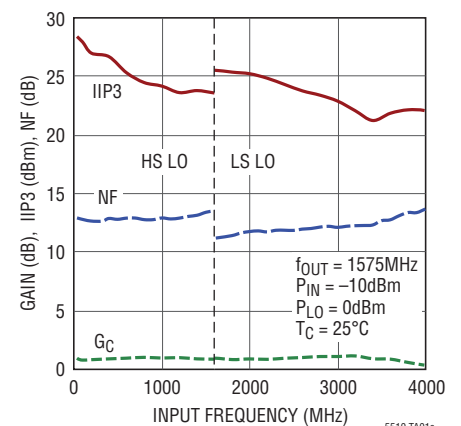

5510 TA01

5510 TA01a

## ABSOLUTE MAXIMUM RATINGS

(Note 1)

Supply Voltage ( $V_{CC1}$ , $V_{CC2}$ , $OUT^+$ , $OUT^-$ )	6.0V
Enable Voltage (EN)	-0.3V to $V_{CC} + 0.3V$
Current Adjust Voltage ( $I_{ADJ}$ )	-0.3V to 2.7V
LO Input Power (1MHz to 6GHz)	+10dBm
LO Differential DC Voltage	1.5V
$LO^+$ , $LO^-$ Input DC Voltage	-0.3V to 3V
$IN^+$ , $IN^-$ Input Power (1MHz to 6GHz)	+15dBm
$IN^+$ , $IN^-$ Input DC Voltage	-0.3V to 2.4V
Temp Monitor Input Current (TEMP)	10mA
Operating Temperature Range ( $T_C$ )	-40°C to 105°C
Storage Temperature Range	-65°C to 150°C
Junction Temperature ( $T_J$ )	150°C

## PIN CONFIGURATION

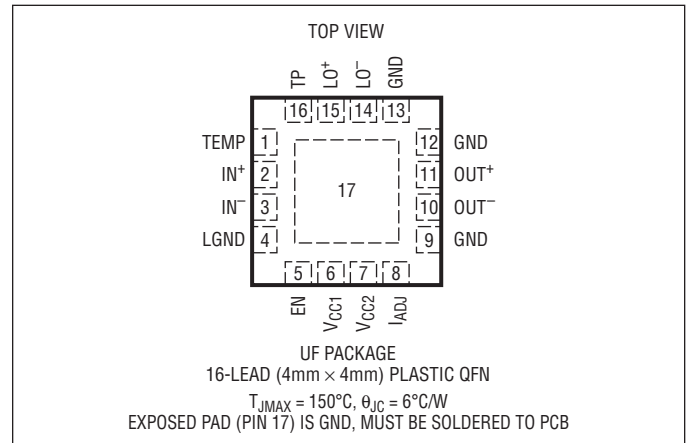

## ORDER INFORMATION

LEAD FREE FINISH	TAPE AND REEL	PART MARKING	PACKAGE DESCRIPTION	TEMPERATURE RANGE
LTC5510IUF#PBF	LTC5510IUF#TRPBF	5510	16-Lead (4mm x 4mm) Plastic QFN	-40°C to 105°C

Consult LTC Marketing for parts specified with wider operating temperature ranges.

For more information on lead free part marking, go to: <http://www.linear.com/leadfree/>

For more information on tape and reel specifications, go to: <http://www.linear.com/tapeandreeel/>

## AC ELECTRICAL CHARACTERISTICS

The ● denotes the specifications which apply over the full operating temperature range, otherwise specifications are at  $T_C = 25^\circ\text{C}$ . EN = High,  $P_{LO} = 0\text{dBm}$ . Test circuit shown in Figure 1. (Notes 2, 3, 4)

PARAMETER	CONDITIONS		MIN	TYP	MAX	UNITS
Input Frequency Range	Requires External Matching	●		1 to 6000		MHz
LO Input Frequency Range		●		1 to 6500		MHz
Output Frequency Range	Requires External Matching	●		1 to 6000		MHz
Input Return Loss	$Z_0 = 50\Omega$ , 30MHz to 3GHz			>11		dB
LO Input Return Loss	$Z_0 = 50\Omega$ , 1MHz to 5GHz			>10		dB
Output Impedance	Differential at 1500MHz			201 $\Omega$   0.6pF		R  C
LO Input Power	$f_{LO} = 1\text{MHz}$ to 5GHz		-6	0	6	dBm

### 5V Wideband Up/Downmixer Application: $f_{IN} = 30\text{MHz}$ to 3000MHz, $f_{OUT} = 1575\text{MHz}$ , $V_{CC} = 5V$ , $R1 = 4.75k\Omega$

Conversion Gain	$f_{IN} = 190\text{MHz}$ , $f_{LO} = 1765\text{MHz}$ , Upmixer		0.5	1.5		dB
	$f_{IN} = 900\text{MHz}$ , $f_{LO} = 2475\text{MHz}$ , Upmixer			1.4		dB
	$f_{IN} = 2150\text{MHz}$ , $f_{LO} = 575\text{MHz}$ , Downmixer			1.1		dB
	$f_{IN} = 2600\text{MHz}$ , $f_{LO} = 1025\text{MHz}$ , Downmixer			1.2		dB
Conversion Gain vs Temperature	$T_C = -40^\circ\text{C}$ to $105^\circ\text{C}$ , $f_{IN} = 900\text{MHz}$	●		-0.007		dB/°C

**AC ELECTRICAL CHARACTERISTICS** The ● denotes the specifications which apply over the full operating temperature range, otherwise specifications are at  $T_C = 25^\circ\text{C}$ . EN = High,  $P_{LO} = 0\text{dBm}$ ,  $P_{IN} = -10\text{dBm}$  ( $-10\text{dBm}/\text{tone}$  for two-tone tests), unless otherwise noted. Test circuit shown in Figure 1. (Notes 2, 3, 4)

PARAMETER	CONDITIONS	MIN	TYP	MAX	UNITS
Two-Tone Output 3rd Order Intercept ( $\Delta f = 2\text{MHz}$ )	$f_{IN} = 190\text{MHz}$ , $f_{LO} = 1765\text{MHz}$ , Upmixer	24.0	27.8		dBm
	$f_{IN} = 900\text{MHz}$ , $f_{LO} = 2475\text{MHz}$ , Upmixer		25.0		dBm
	$f_{IN} = 2150\text{MHz}$ , $f_{LO} = 575\text{MHz}$ , Downmixer		26.0		dBm
	$f_{IN} = 2600\text{MHz}$ , $f_{LO} = 1025\text{MHz}$ , Downmixer		24.5		dBm
SSB Noise Figure	$f_{IN} = 190\text{MHz}$ , $f_{LO} = 1765\text{MHz}$ , Upmixer		11.6	14.5	dB
	$f_{IN} = 900\text{MHz}$ , $f_{LO} = 2475\text{MHz}$ , Upmixer		12.1		dB
	$f_{IN} = 2150\text{MHz}$ , $f_{LO} = 575\text{MHz}$ , Downmixer		11.6		dB
	$f_{IN} = 2600\text{MHz}$ , $f_{LO} = 1025\text{MHz}$ , Downmixer		11.8		dB
SSB Noise Figure Under Blocking	$f_{IN} = 900\text{MHz}$ , $f_{LO} = 2475\text{MHz}$ , $f_{BLOCK} = 800\text{MHz}$ , $P_{BLOCK} = +5\text{dBm}$		20.3		dB
LO-IN Leakage	$f_{LO} = 20\text{MHz}$ to $3300\text{MHz}$		<-50		dBm
LO-OUT Leakage	$f_{LO} = 20\text{MHz}$ to $1000\text{MHz}$		<-40		dBm
	$f_{LO} = 1000\text{MHz}$ to $3300\text{MHz}$		<-33		dBm
IN-OUT Isolation	$f_{IN} = 20\text{MHz}$ to $1150\text{MHz}$		>40		dB
	$f_{IN} = 1150\text{MHz}$ to $3000\text{MHz}$		>22		dB
IN-LO Isolation	$f_{IN} = 30\text{MHz}$ to $3000\text{MHz}$		>55		dB
Input 1dB Compression	$f_{IN} = 190\text{MHz}$ , $f_{LO} = 1765\text{MHz}$ , Upmixer		11.0		dBm
	$f_{IN} = 900\text{MHz}$ , $f_{LO} = 2475\text{MHz}$ , Upmixer		12.2		dBm
	$f_{IN} = 2150\text{MHz}$ , $f_{LO} = 575\text{MHz}$ , Downmixer		11.5		dBm
	$f_{IN} = 2600\text{MHz}$ , $f_{LO} = 1025\text{MHz}$ , Downmixer		11.6		dBm

**3.3V Wideband Up/Downmixer Application:  $f_{IN} = 30\text{MHz}$  to  $3000\text{MHz}$ ,  $f_{OUT} = 1575\text{MHz}$ ,  $V_{CC} = 3.3\text{V}$ ,  $R1 = 1.8\text{k}\Omega$**

Conversion Gain	$f_{IN} = 190\text{MHz}$ , $f_{LO} = 1765\text{MHz}$ , Upmixer		1.5		dB
	$f_{IN} = 900\text{MHz}$ , $f_{LO} = 2475\text{MHz}$ , Upmixer		1.4		dB
	$f_{IN} = 2150\text{MHz}$ , $f_{LO} = 575\text{MHz}$ , Downmixer		1.1		dB
	$f_{IN} = 2600\text{MHz}$ , $f_{LO} = 1025\text{MHz}$ , Downmixer		1.2		dB
Conversion Gain vs Temperature	$T_C = -40^\circ\text{C}$ to $105^\circ\text{C}$ , $f_{IN} = 900\text{MHz}$	●	-0.006		dB/ $^\circ\text{C}$
Two-Tone Output 3rd Order Intercept ( $\Delta f = 2\text{MHz}$ )	$f_{IN} = 190\text{MHz}$ , $f_{LO} = 1765\text{MHz}$ , Upmixer		24.2		dBm
	$f_{IN} = 900\text{MHz}$ , $f_{LO} = 2475\text{MHz}$ , Upmixer		23.3		dBm
	$f_{IN} = 2150\text{MHz}$ , $f_{LO} = 575\text{MHz}$ , Downmixer		23.9		dBm
	$f_{IN} = 2600\text{MHz}$ , $f_{LO} = 1025\text{MHz}$ , Downmixer		22.3		dBm
SSB Noise Figure	$f_{IN} = 190\text{MHz}$ , $f_{LO} = 1765\text{MHz}$ , Upmixer		11.2		dB
	$f_{IN} = 900\text{MHz}$ , $f_{LO} = 2475\text{MHz}$ , Upmixer		12.2		dB
	$f_{IN} = 2150\text{MHz}$ , $f_{LO} = 575\text{MHz}$ , Downmixer		11.4		dB
	$f_{IN} = 2600\text{MHz}$ , $f_{LO} = 1025\text{MHz}$ , Downmixer		11.4		dB
SSB Noise Figure Under Blocking	$f_{IN} = 900\text{MHz}$ , $f_{LO} = 2475\text{MHz}$ , $f_{BLOCK} = 800\text{MHz}$ , $P_{BLOCK} = +5\text{dBm}$		20.8		dB
LO-IN Leakage	$f_{LO} = 20\text{MHz}$ to $3300\text{MHz}$		<-50		dBm
LO-OUT Leakage	$f_{LO} = 20\text{MHz}$ to $1000\text{MHz}$		<-40		dBm
	$f_{LO} = 1000\text{MHz}$ to $3300\text{MHz}$		<-33		dBm
IN-OUT Isolation	$f_{IN} = 20\text{MHz}$ to $1150\text{MHz}$		>40		dB
	$f_{IN} = 1150\text{MHz}$ to $3000\text{MHz}$		>22		dB
IN-LO Isolation	$f_{IN} = 30\text{MHz}$ to $3000\text{MHz}$		>55		dB
Input 1dB Compression	$f_{IN} = 190\text{MHz}$ , $f_{LO} = 1765\text{MHz}$ , Upmixer		8.9		dBm
	$f_{IN} = 900\text{MHz}$ , $f_{LO} = 2475\text{MHz}$ , Upmixer		10.7		dBm
	$f_{IN} = 2150\text{MHz}$ , $f_{LO} = 575\text{MHz}$ , Downmixer		10.1		dBm
	$f_{IN} = 2600\text{MHz}$ , $f_{LO} = 1025\text{MHz}$ , Downmixer		9.6		dBm

**AC ELECTRICAL CHARACTERISTICS** The ● denotes the specifications which apply over the full operating temperature range, otherwise specifications are at  $T_C = 25^\circ\text{C}$ . EN = High,  $P_{LO} = 0\text{dBm}$ ,  $P_{IN} = -10\text{dBm}$  ( $-10\text{dBm}/\text{tone}$  for two-tone tests), unless otherwise noted. Test circuit shown in Figure 1. (Notes 2, 3, 4)

PARAMETER	CONDITIONS	MIN	TYP	MAX	UNITS
<b>5V Wideband Upmixer Application: <math>f_{IN} = 30\text{MHz}</math> to <math>1000\text{MHz}</math>, <math>f_{OUT} = 2140\text{MHz}</math>, <math>f_{LO} = f_{IN} + f_{OUT}</math>, <math>V_{CC} = 5\text{V}</math>, <math>R1 = 4.75\text{k}\Omega</math></b>					
Conversion Gain	$f_{IN} = 190\text{MHz}$ $f_{IN} = 450\text{MHz}$ $f_{IN} = 900\text{MHz}$		1.1 1.0 1.0		dB dB dB
Conversion Gain vs Temperature	$T_C = -40^\circ\text{C}$ to $105^\circ\text{C}$ , $f_{IN} = 190\text{MHz}$	●	-0.006		dB/ $^\circ\text{C}$
Two-Tone Output 3rd Order Intercept ( $\Delta f = 2\text{MHz}$ )	$f_{IN} = 190\text{MHz}$ $f_{IN} = 450\text{MHz}$ $f_{IN} = 900\text{MHz}$		25.6 24.6 23.9		dBm dBm dBm
SSB Noise Figure	$f_{IN} = 190\text{MHz}$ $f_{IN} = 450\text{MHz}$ $f_{IN} = 900\text{MHz}$		12.0 12.2 12.4		dB dB dB
SSB Noise Floor at $P_{IN} = +5\text{dBm}$	$f_{IN} = 800\text{MHz}$ , $f_{LO} = 3040\text{MHz}$ , $f_{OUT} = 2140\text{MHz}$		-151.4		dBm/Hz
LO-IN Leakage	$f_{LO} = 2100\text{MHz}$ to $3500\text{MHz}$		<-50		dBm
LO-OUT Leakage	$f_{LO} = 2100\text{MHz}$ to $3500\text{MHz}$		<-31		dBm
IN-OUT Isolation	$f_{IN} = 30\text{MHz}$ to $1100\text{MHz}$		>40		dB
IN-LO Isolation	$f_{IN} = 30\text{MHz}$ to $1100\text{MHz}$		>50		dB
Input 1dB Compression	$f_{IN} = 190\text{MHz}$ $f_{IN} = 450\text{MHz}$ $f_{IN} = 900\text{MHz}$		11.5 11.5 11.7		dBm dBm dBm
<b>5V VHF/UHF Wideband Downmixer Application: <math>f_{IN} = 100\text{MHz}</math> to <math>1000\text{MHz}</math>, <math>f_{OUT} = 44\text{MHz}</math>, <math>f_{LO} = f_{IN} + f_{OUT}</math>, <math>V_{CC} = 5\text{V}</math>, <math>R1 = \text{Open}</math></b>					
Conversion Gain	$f_{IN} = 140\text{MHz}$ $f_{IN} = 456\text{MHz}$ $f_{IN} = 900\text{MHz}$		1.9 1.9 1.9		dB dB dB
Conversion Gain vs Temperature	$T_C = -40^\circ\text{C}$ to $105^\circ\text{C}$ , $f_{IN} = 456\text{MHz}$	●	-0.006		dB/ $^\circ\text{C}$
Two-Tone Input 3rd Order Intercept ( $\Delta f = 2\text{MHz}$ )	$f_{IN} = 140\text{MHz}$ $f_{IN} = 456\text{MHz}$ $f_{IN} = 900\text{MHz}$		27.8 28.5 26.8		dBm dBm dBm
SSB Noise Figure	$f_{IN} = 140\text{MHz}$ $f_{IN} = 456\text{MHz}$ $f_{IN} = 900\text{MHz}$		10.8 10.9 11.6		dB dB dB
SSB Noise Figure Under Blocking	$f_{IN} = 900\text{MHz}$ , $f_{LO} = 944\text{MHz}$ , $f_{BLOCK} = 800\text{MHz}$ , $P_{BLOCK} = +5\text{dBm}$		20.0		dB
Two-Tone Input 2nd Order Intercept ( $\Delta f = f_{IM2} = 42\text{MHz}$ )	$f_{IN1} = 477\text{MHz}$ , $f_{IN2} = 435\text{MHz}$ , $f_{LO} = 500\text{MHz}$		72		dBm
2LO-2RF Output Spurious Product ( $f_{IN} = f_{LO} - f_{OUT}/2$ )	$f_{IN} = 478\text{MHz}$ at $-6\text{dBm}$ , $f_{LO} = 500\text{MHz}$ , $f_{OUT} = 44\text{MHz}$		-84		dBc
3LO-3RF Output Spurious Product ( $f_{IN} = f_{LO} - f_{OUT}/3$ )	$f_{IN} = 485.33\text{MHz}$ at $-6\text{dBm}$ , $f_{LO} = 500\text{MHz}$ , $f_{OUT} = 44.01\text{MHz}$		-82		dBc
LO-IN Leakage	$f_{LO} = 50\text{MHz}$ to $1200\text{MHz}$		<-62		dBm
LO-OUT Leakage	$f_{LO} = 50\text{MHz}$ to $1200\text{MHz}$		<-31		dBm
IN-OUT Isolation	$f_{IN} = 50\text{MHz}$ to $1000\text{MHz}$		>23		dB
IN-LO Isolation	$f_{IN} = 50\text{MHz}$ to $1000\text{MHz}$		>62		dB
Input 1dB Compression	$f_{IN} = 456\text{MHz}$		12.1		dBm

**AC ELECTRICAL CHARACTERISTICS** The ● denotes the specifications which apply over the full operating temperature range, otherwise specifications are at  $T_C = 25^\circ\text{C}$ . EN = High,  $P_{LO} = 0\text{dBm}$ ,  $P_{IN} = -10\text{dBm}$  ( $-10\text{dBm}/\text{tone}$  for two-tone tests), unless otherwise noted. Test circuit shown in Figure 1 (Notes 2, 3, 4)

PARAMETER	CONDITIONS		MIN	TYP	MAX	UNITS
<b>5V VHF/UHF Upmixer Application: <math>f_{IN} = 70\text{MHz}</math>, <math>f_{OUT} = 100\text{MHz}</math> to <math>1000\text{MHz}</math>, <math>f_{LO} = f_{IN} + f_{OUT}</math>, <math>V_{CC} = 5\text{V}</math>, <math>R1 = \text{Open}</math>, <math>L3 = 220\text{nH}</math></b>						
Conversion Gain	$f_{OUT} = 456\text{MHz}$			1.1		dB
Conversion Gain vs Temperature	$T_C = -40^\circ\text{C}$ to $105^\circ\text{C}$ , $f_{OUT} = 456\text{MHz}$	●		-0.007		dB/ $^\circ\text{C}$
Two-Tone Output 3rd Order Intercept ( $\Delta f = 2\text{MHz}$ )	$f_{OUT} = 456\text{MHz}$			29.0		dBm
SSB Noise Figure	$f_{OUT} = 456\text{MHz}$			11.3		dB
SSB Noise Floor at $P_{IN} = +5\text{dBm}$	$f_{IN} = 44\text{MHz}$ , $f_{LO} = 532\text{MHz}$ , $f_{OUT} = 462\text{MHz}$			-152		dBm/Hz
LO-IN Leakage	$f_{LO} = 100\text{MHz}$ to $1500\text{MHz}$			<-62		dBm
LO-OUT Leakage	$f_{LO} = 100\text{MHz}$ to $1500\text{MHz}$			<-39		dBm
IN-OUT Isolation	$f_{IN} = 50\text{MHz}$ to $400\text{MHz}$			>43		dB
IN-LO Isolation	$f_{IN} = 50\text{MHz}$ to $400\text{MHz}$			>70		dB
Input 1dB Compression	$f_{OUT} = 456\text{MHz}$			11.0		dBm

**DC ELECTRICAL CHARACTERISTICS** The ● denotes the specifications which apply over the full operating temperature range, otherwise specifications are at  $T_C = 25^\circ\text{C}$ .  $V_{CC} = 5\text{V}$ , EN = High, unless otherwise noted. Test circuit shown in Figure 1. (Note 2)

PARAMETER	CONDITIONS		MIN	TYP	MAX	UNITS
<b>Power Supply</b>						
Supply Voltage (Pins 6, 7, 10, 11)	5V Supply	●	4.5	5	5.3	V
	3.3V Supply	●	3.1	3.3	3.5	V
Supply Current (Pins 6, 7, 10, 11)	5V, $R1 = \text{Open}$			105		mA
	5V, $R1 = 4.75\text{k}$			99.6	113	mA
	3.3V, $R1 = \text{Open}$			105		mA
	3.3V, $R1 = 1.8\text{k}$			94		mA
Total Supply Current – Shutdown	EN = Low			1.3	2.5	mA
<b>Enable Logic Input (EN)</b>						
EN Input High Voltage (On)		●	1.8			V
EN Input Low Voltage (Off)		●			0.5	V
EN Input Current	$-0.3\text{V}$ to $V_{CC} + 0.3\text{V}$		-20		200	$\mu\text{A}$
Turn-On Time	EN: Low to High			0.6		$\mu\text{s}$
Turn-Off Time	EN: High to Low			0.6		$\mu\text{s}$
<b>Current Adjust Pin (<math>I_{ADJ}</math>)</b>						
Open Circuit DC Voltage				1.8		V
Short Circuit DC Current	$I_{ADJ}$ Shorted to Ground			1.9		mA
<b>Temperature Monitor Pin (TEMP)</b>						
DC Voltage at $T_J = 25^\circ\text{C}$	$I_{IN} = 10\mu\text{A}$			697		mV
	$I_{IN} = 80\mu\text{A}$			755		mV
Voltage Temperature Coefficient	$I_{IN} = 10\mu\text{A}$	●		-1.80		mV/ $^\circ\text{C}$
	$I_{IN} = 80\mu\text{A}$	●		-1.61		mV/ $^\circ\text{C}$

**Note 1:** Stresses beyond those listed under Absolute Maximum Ratings may cause permanent damage to the device. Exposure to any Absolute Maximum Rating condition for extended periods may affect device reliability and lifetime.

**Note 2:** The LTC5510 is guaranteed functional over the case operating temperature range of  $-40^\circ\text{C}$  to  $105^\circ\text{C}$ . ( $\theta_{JC} = 6^\circ\text{C}/\text{W}$ )

**Note 3:** SSB Noise Figure measured with a small-signal noise source, bandpass filter and 3dB matching pad on the signal input, bandpass filter and 6dB matching pad on the LO input, and no other RF signals applied.

**Note 4:** Specified performance includes all external component and evaluation PCB losses.

**TYPICAL DC PERFORMANCE CHARACTERISTICS** (Test Circuit Shown in Figure 1)

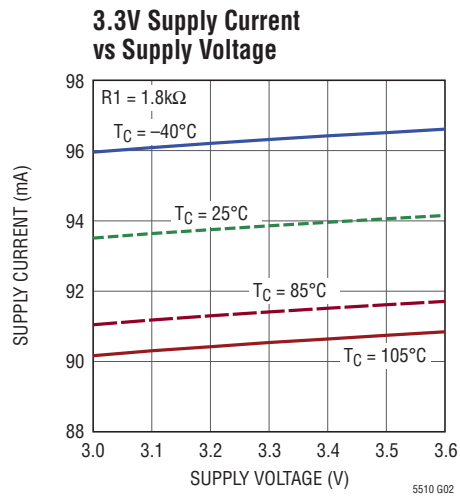
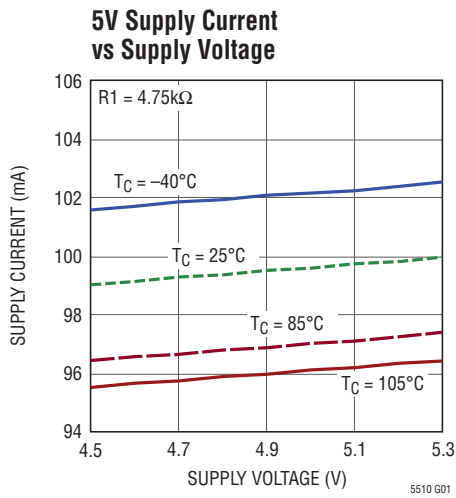

**TYPICAL AC PERFORMANCE CHARACTERISTICS** 5V Wideband Up/Downmixer Application:  
 $V_{CC} = 5V$ ,  $T_C = 25^\circ C$ ,  $f_{IN} = 190MHz$ ,  $P_{IN} = -10dBm$  (-10dBm/tone for 2-tone tests,  $\Delta f = 2MHz$ ),  $f_{LO} = 1765MHz$ ,  $P_{LO} = 0dBm$ , output measured at 1575MHz, unless otherwise noted. (Test Circuit Shown in Figure 1).

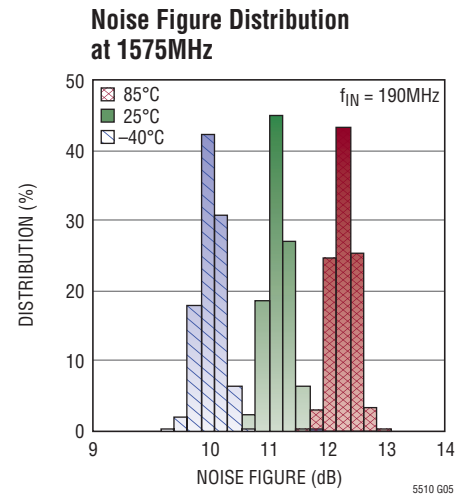
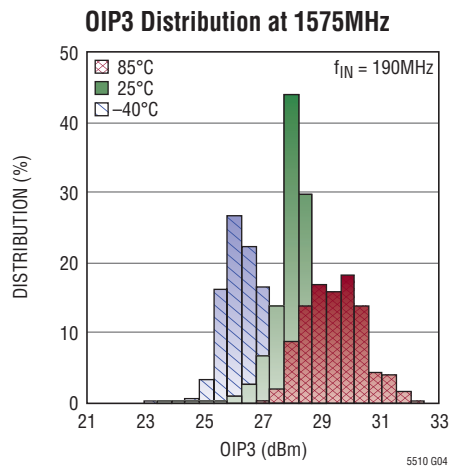
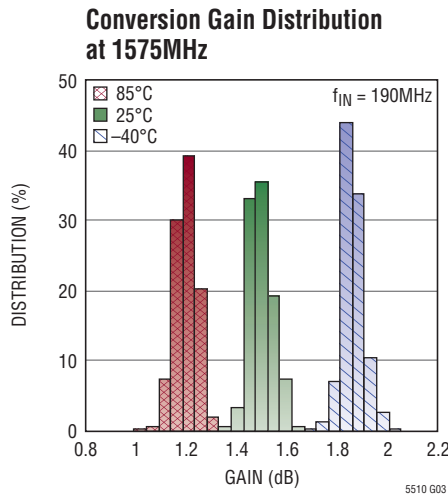

**TYPICAL AC PERFORMANCE CHARACTERISTICS** 5V Wideband Up/Downmixer Application for  $f_{IN} < 1575\text{MHz}$ ;  $V_{CC} = 5\text{V}$ ,  $T_C = 25^\circ\text{C}$ ,  $f_{IN} = 190\text{MHz}$ ,  $P_{IN} = -10\text{dBm}$  (-10dBm/tone for 2-tone tests,  $\Delta f = 2\text{MHz}$ ), HSL0,  $P_{LO} = 0\text{dBm}$ , output measured at 1575MHz, unless otherwise noted. (Test Circuit Shown in Figure 1).

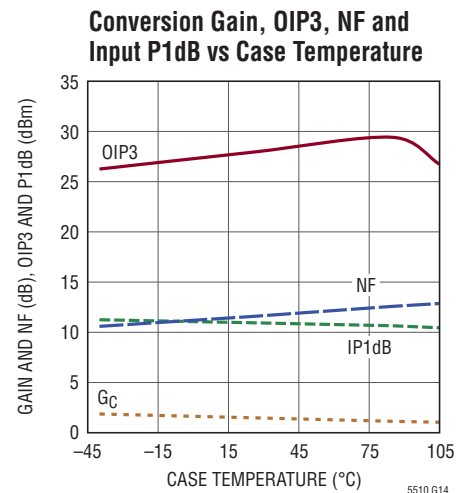
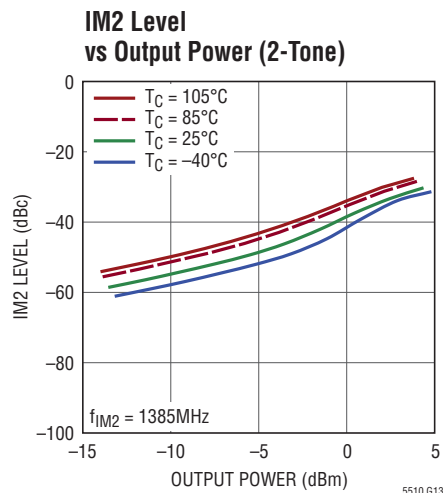
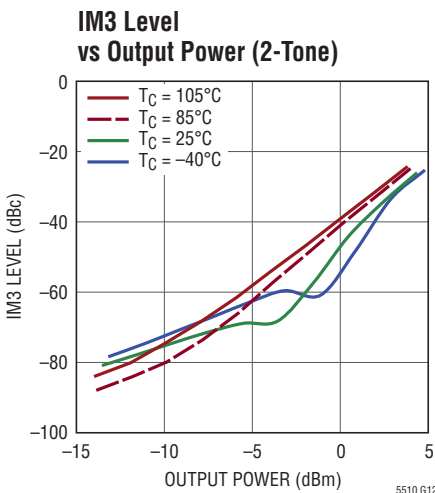
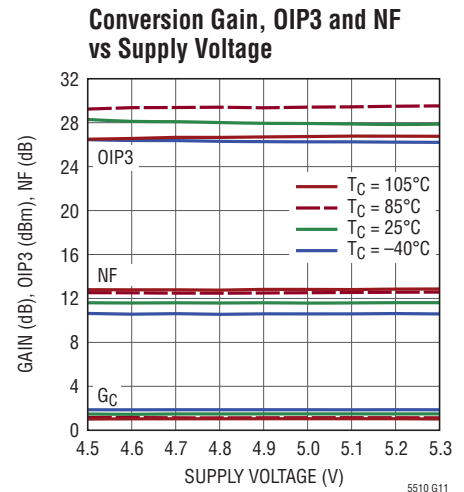
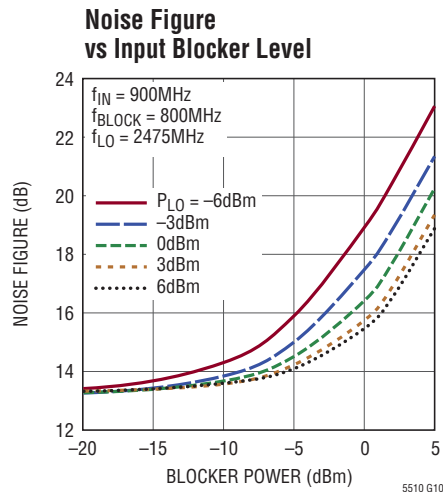
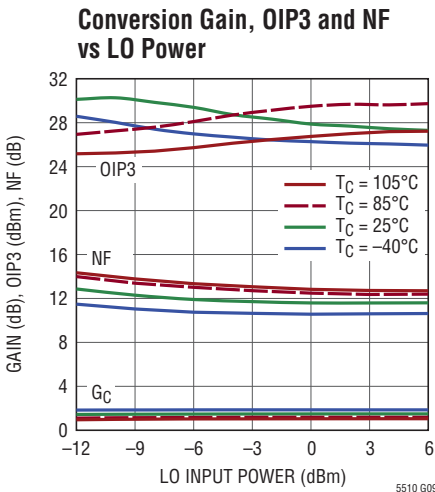
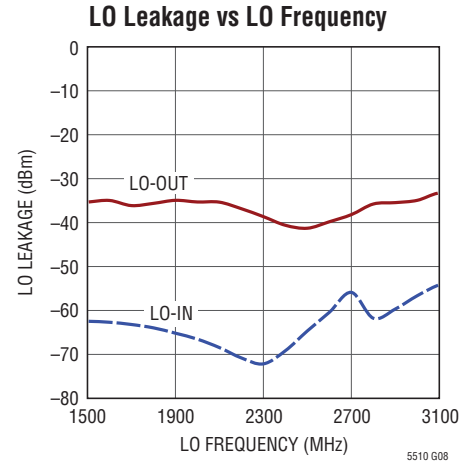
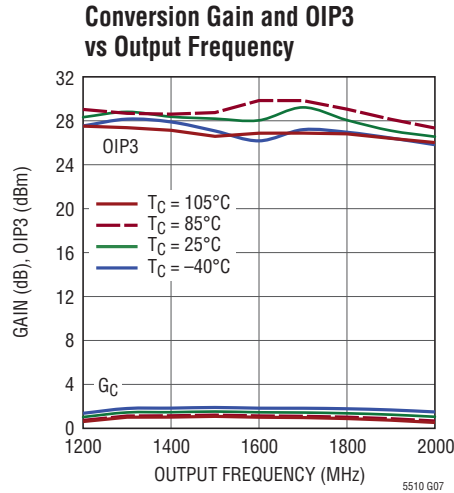
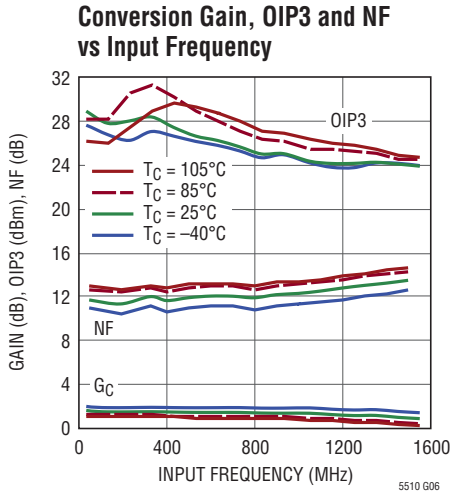

## TYPICAL AC PERFORMANCE CHARACTERISTICS 5V Wideband Up/Downmixer Application

for  $f_{IN} > 1575\text{MHz}$ ;  $V_{CC} = 5\text{V}$ ,  $T_C = 25^\circ\text{C}$ ,  $f_{IN} = 2150\text{MHz}$ ,  $P_{IN} = -10\text{dBm}$  (-10dBm/tone for 2-tone tests,  $\Delta f = 2\text{MHz}$ ), LSLO,  $P_{LO} = 0\text{dBm}$ , output measured at 1575MHz, unless otherwise noted. (Test Circuit Shown in Figure 1).

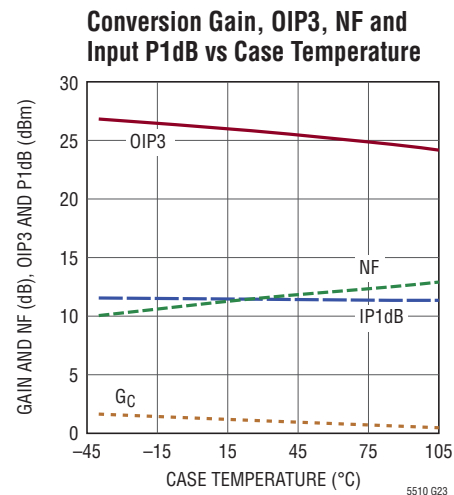
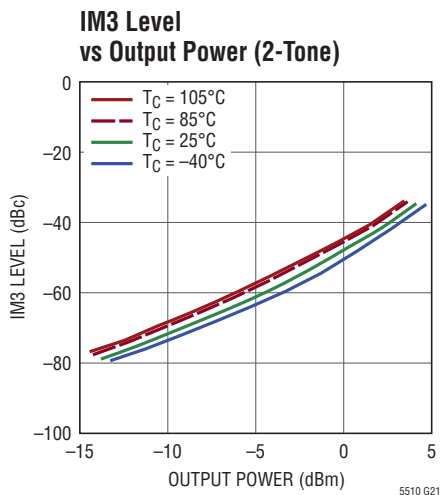
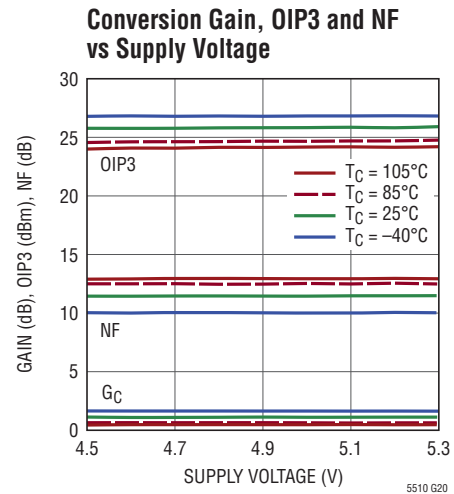
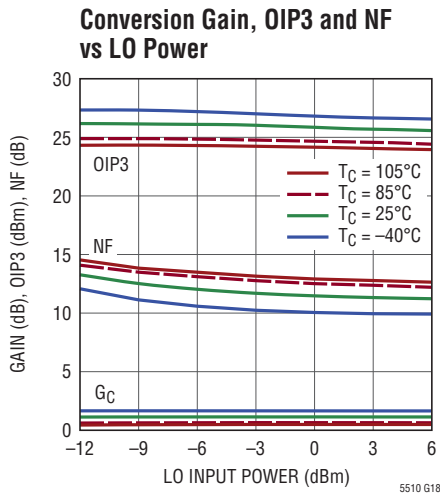
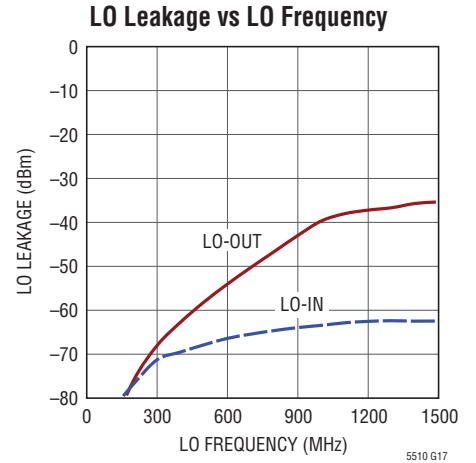
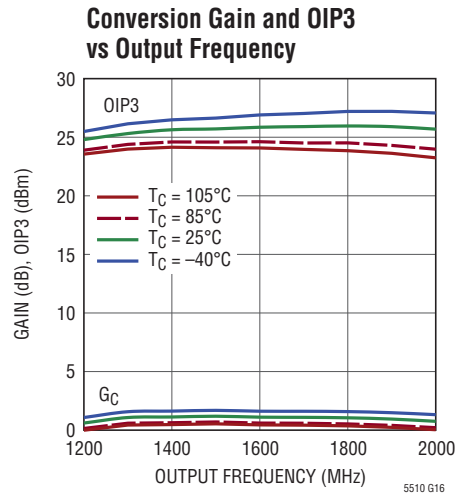
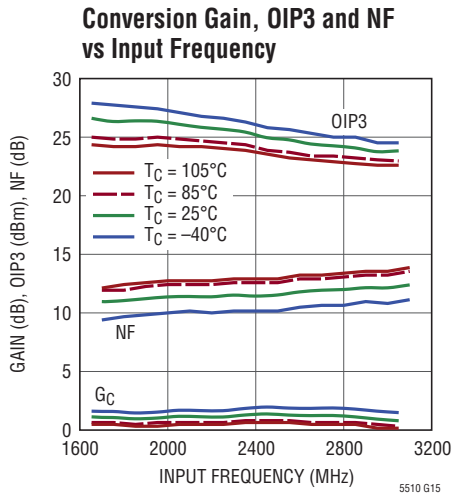



**TYPICAL AC PERFORMANCE CHARACTERISTICS** 3.3V Wideband Up/Downmixer Application  
 for  $f_{IN} < 1575\text{MHz}$ :  $V_{CC} = 3.3\text{V}$ ,  $T_C = 25^\circ\text{C}$ ,  $f_{IN} = 190\text{MHz}$ ,  $P_{IN} = -10\text{dBm}$  ( $-10\text{dBm}/\text{tone}$  for 2-tone tests,  $\Delta f = 2\text{MHz}$ ),  $\text{HSLO}$ ,  $P_{LO} = 0\text{dBm}$ ,  
 output measured at  $1575\text{MHz}$ , unless otherwise noted. (Test Circuit Shown in Figure 1).

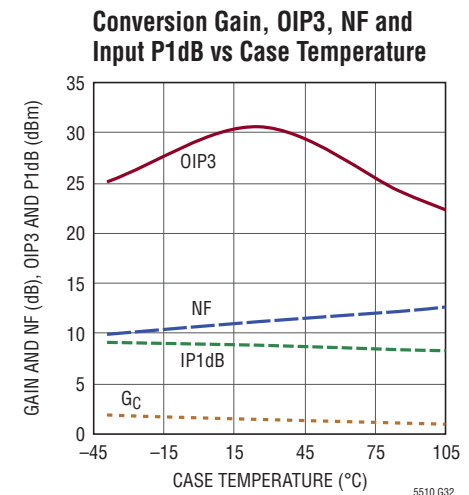
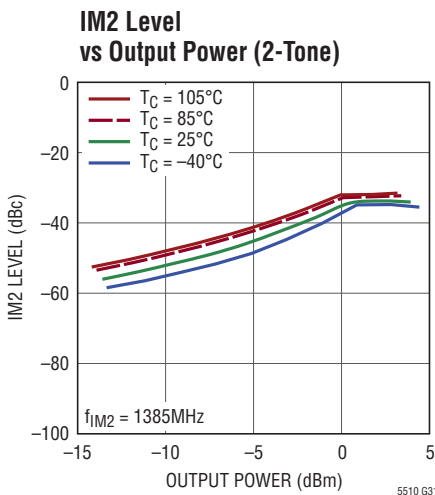
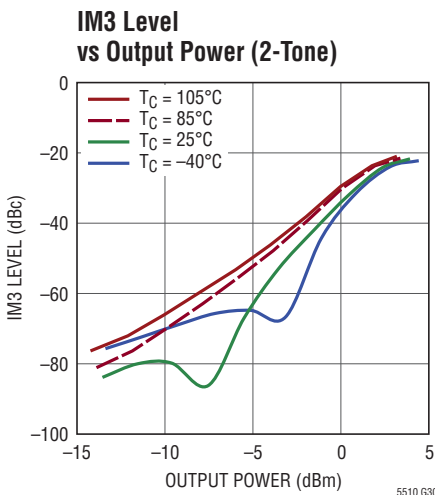
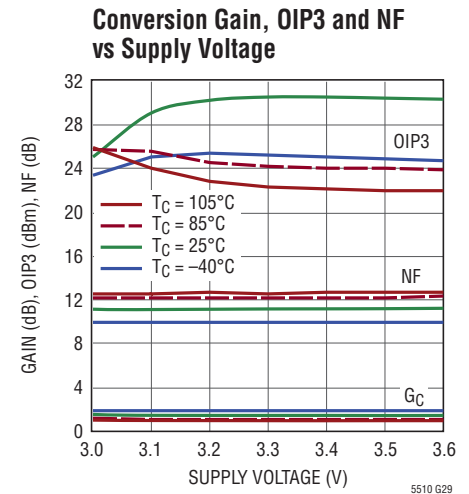
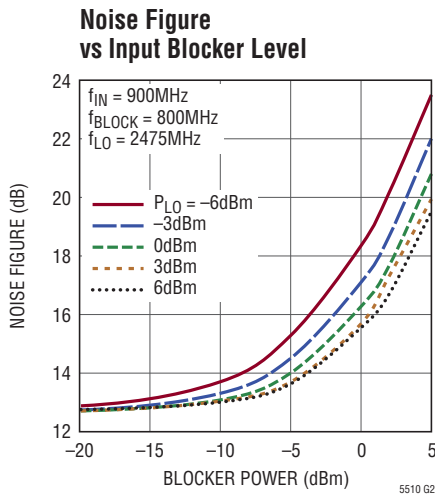
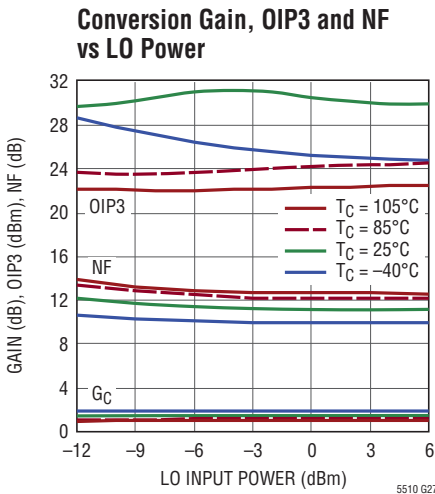
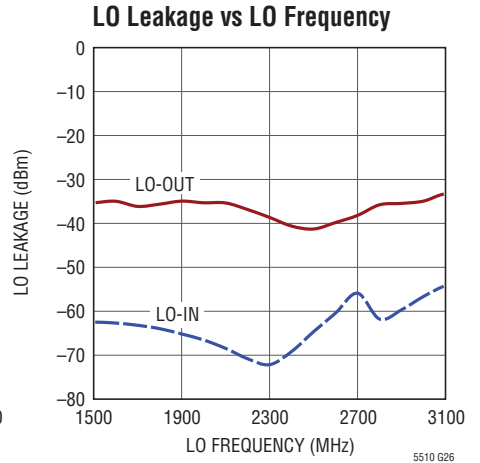
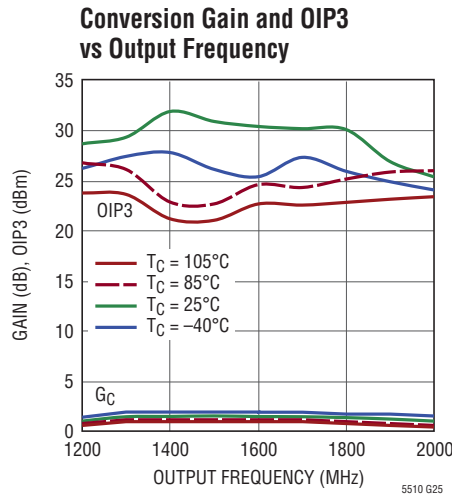
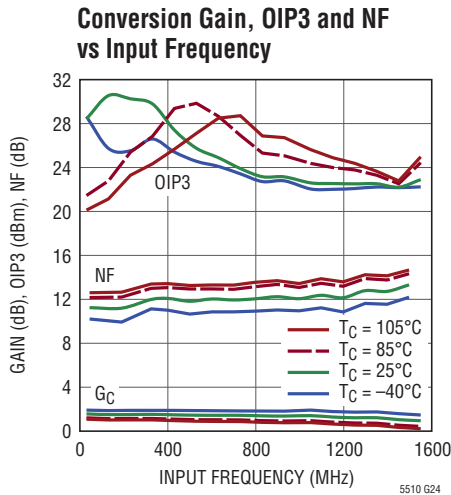

## TYPICAL AC PERFORMANCE CHARACTERISTICS 3.3V Wideband Up/Downmixer Application for $f_{IN} > 1575\text{MHz}$ : $V_{CC} = 3.3\text{V}$ , $T_C = 25^\circ\text{C}$ , $f_{IN} = 2150\text{MHz}$ , $P_{IN} = -10\text{dBm}$ (-10dBm/tone for 2-tone tests, $\Delta f = 2\text{MHz}$ ), LSL0, $P_{LO} = 0\text{dBm}$ , output measured at 1575MHz, unless otherwise noted. (Test Circuit Shown in Figure 1).

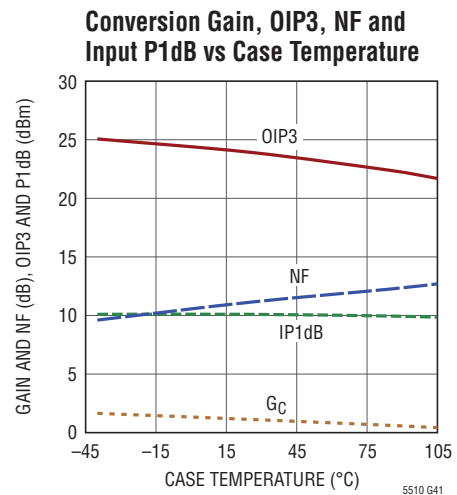
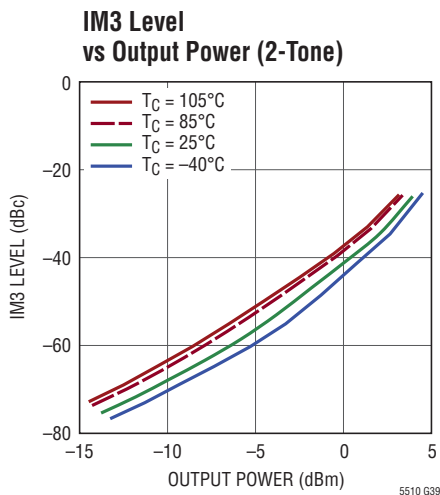
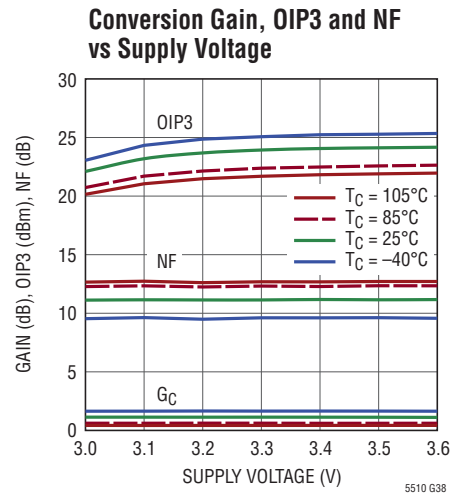
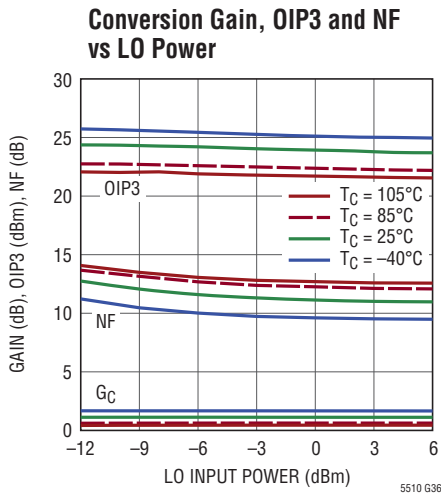
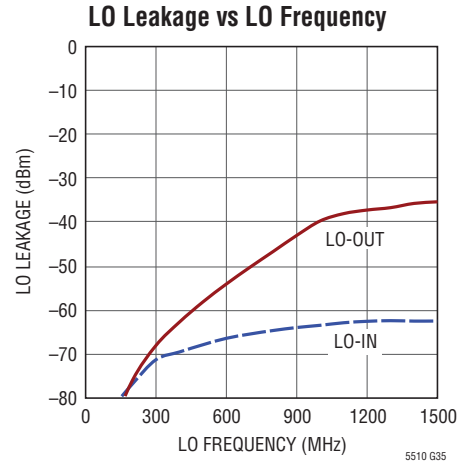
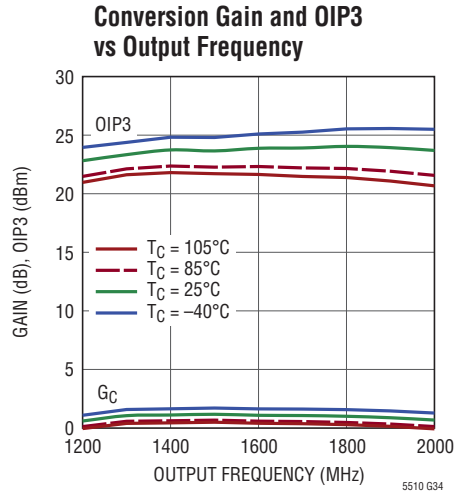
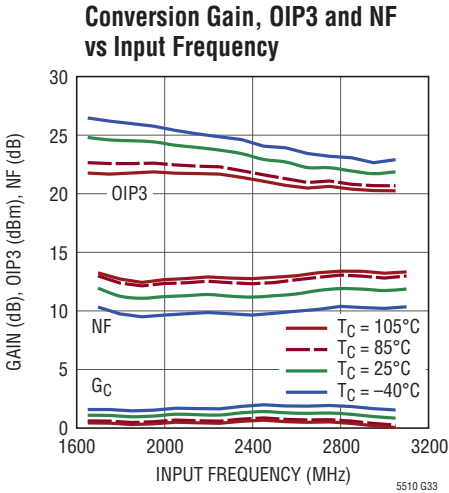

**TYPICAL AC PERFORMANCE CHARACTERISTICS** 5V Wideband Upmixer Application:  
 $V_{CC} = 5V$ ,  $T_C = 25^\circ C$ ,  $f_{IN} = 190MHz$ ,  $P_{IN} = -10dBm$  (-10dBm/tone for 2-tone tests,  $\Delta f = 2MHz$ ), HSL0,  $P_{LO} = 0dBm$ , output measured at 2140MHz, unless otherwise noted. (Test Circuit Shown in Figure 1).

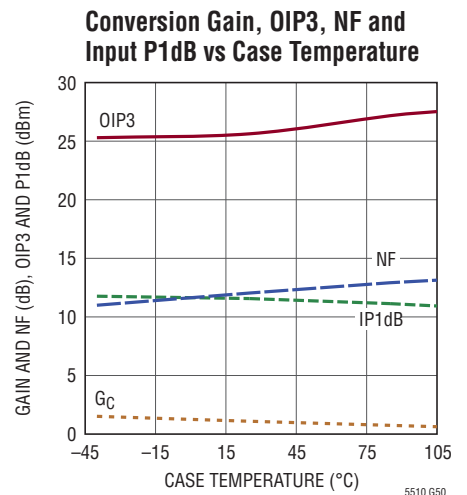
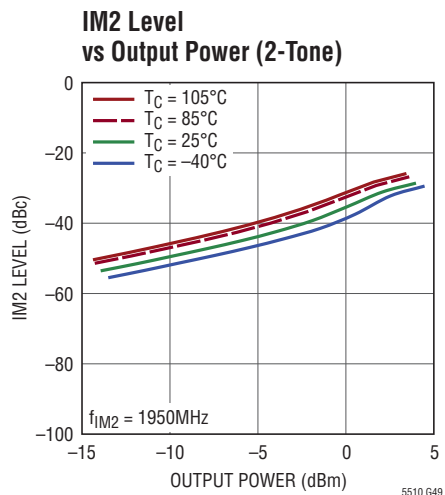
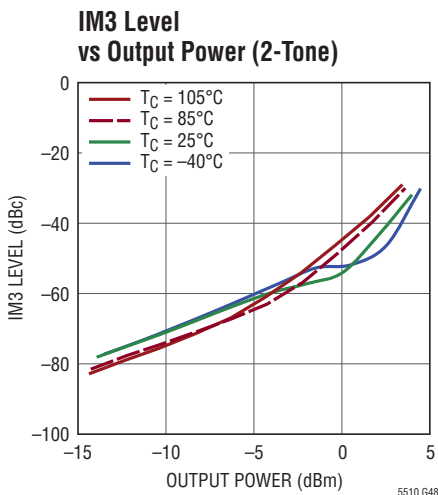
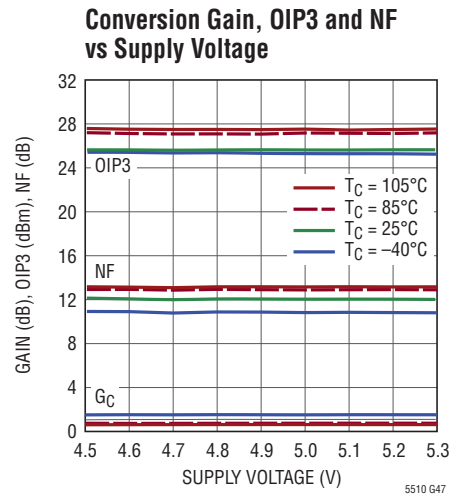
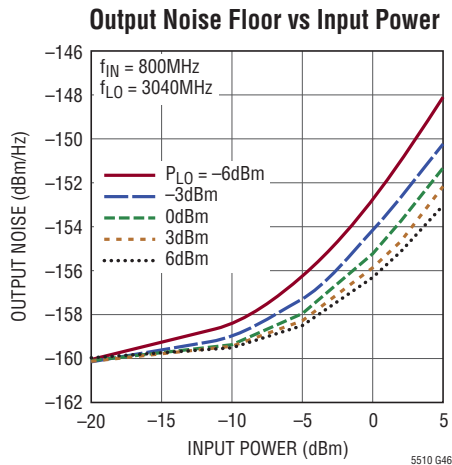
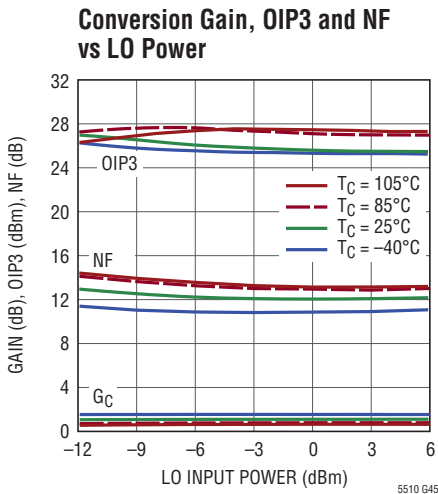
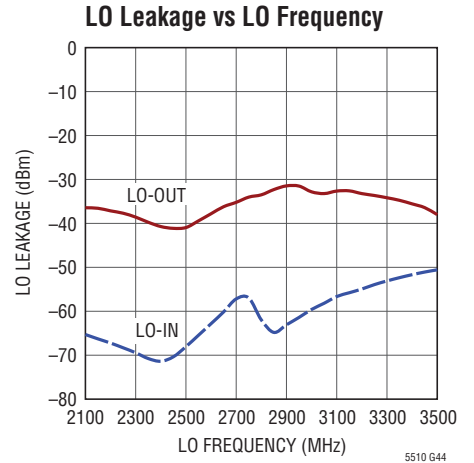
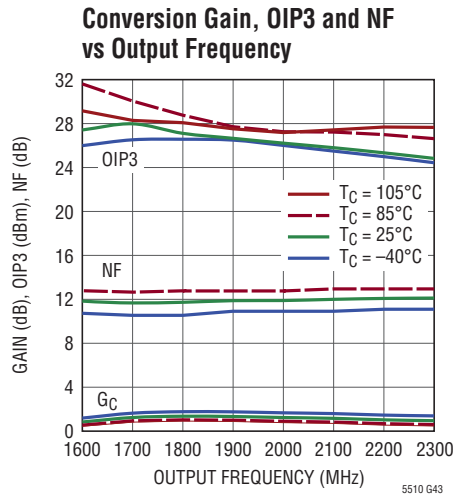
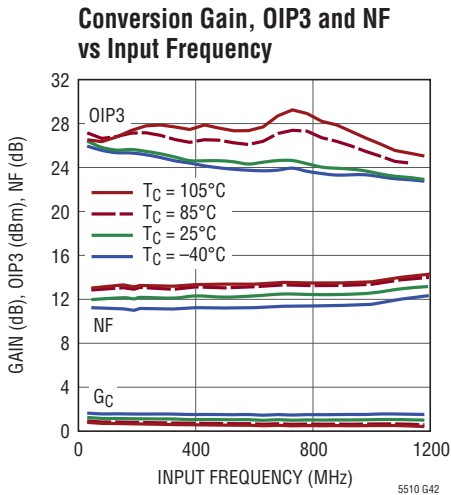

## TYPICAL AC PERFORMANCE CHARACTERISTICS 5V VHF/UHF Upmixer Application: $V_{CC} = 5V$ , $T_C = 25^\circ C$ , $f_{IN} = 70MHz$ , $P_{IN} = -10dBm$ (-10dBm/tone for 2-tone tests, $\Delta f = 2MHz$ ), HSLO, $P_{LO} = 0dBm$ , output measured at 456MHz, unless otherwise noted. (Test Circuit Shown in Figure 2).

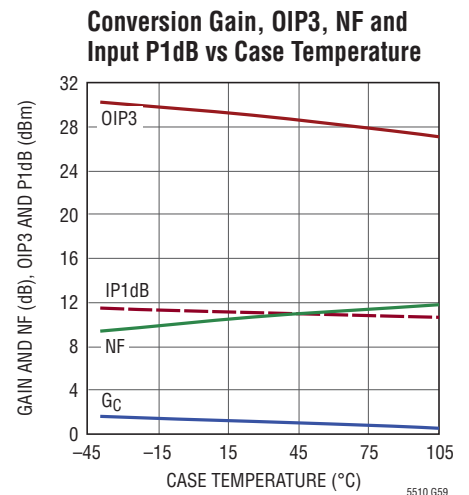
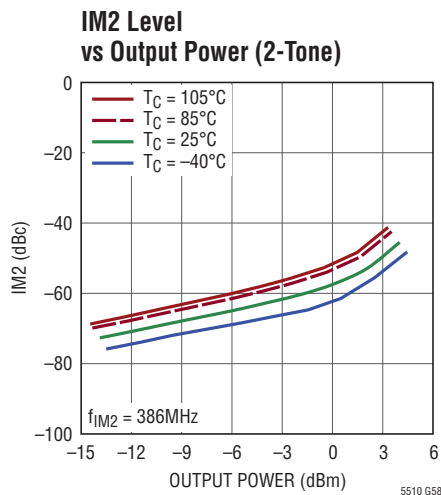
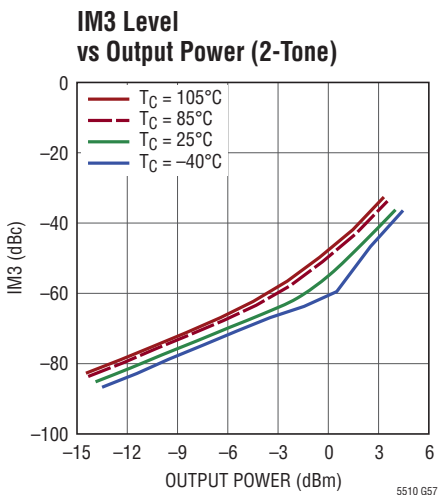
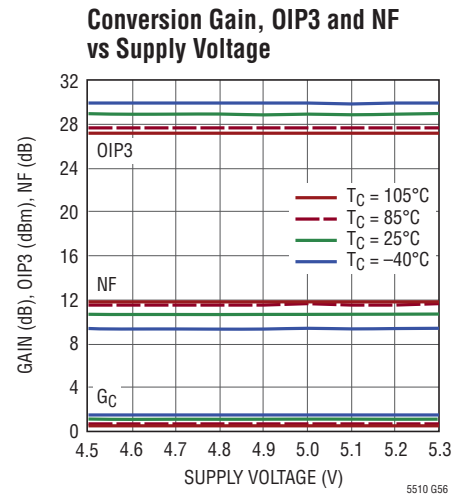
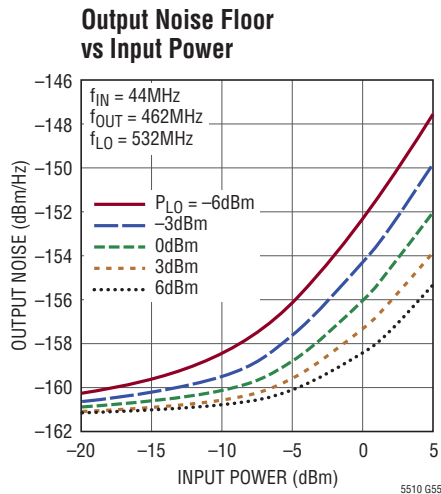
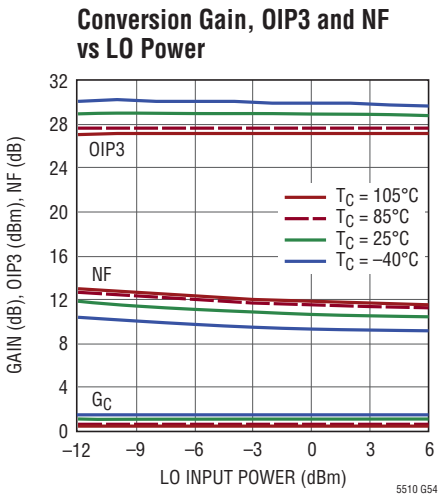
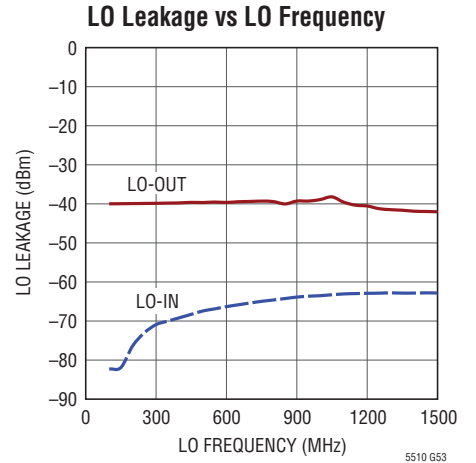
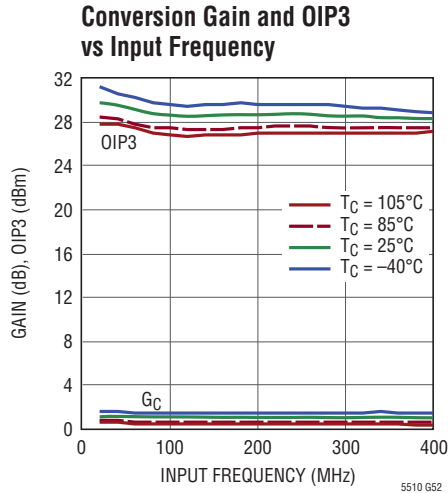
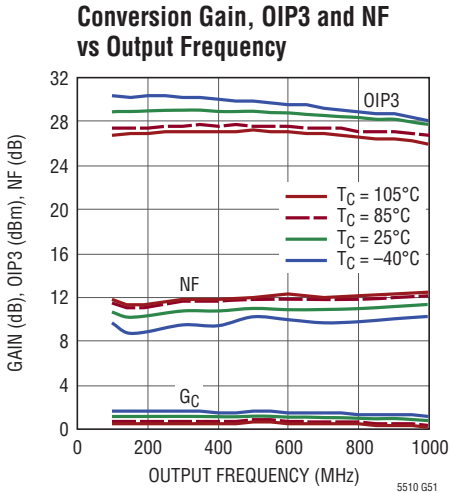

**TYPICAL AC PERFORMANCE CHARACTERISTICS** 5V VHF/UHF Downmixer Application:  
 $V_{CC} = 5V$ ,  $T_C = 25^\circ C$ ,  $f_{IN} = 456MHz$ ,  $P_{IN} = -10dBm$  (-10dBm/tone for 2-tone tests,  $\Delta f = 2MHz$ ), HSL0,  $P_{LO} = 0dBm$ , output measured at 44MHz, unless otherwise noted. (Test Circuit Shown in Figure 2).

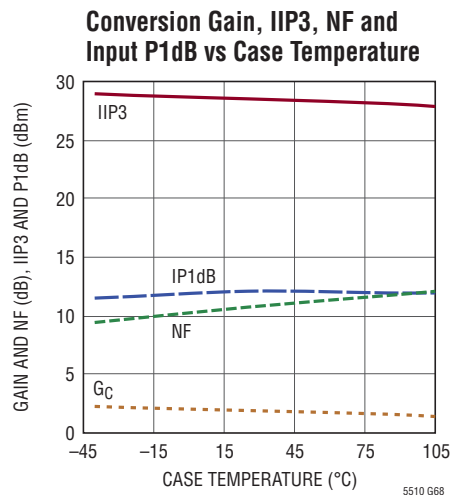
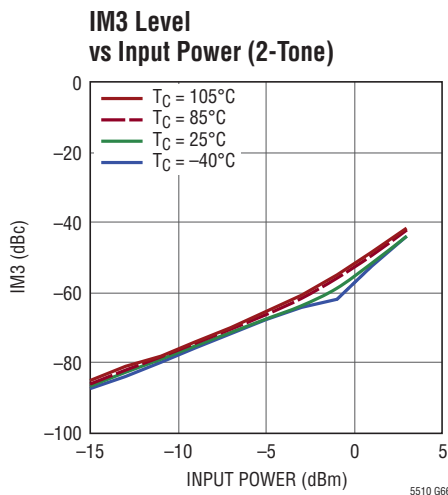
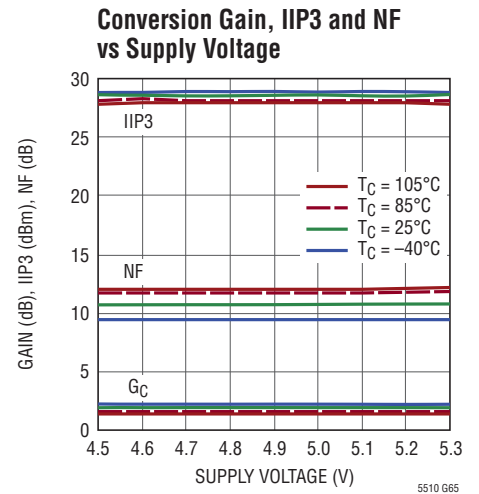
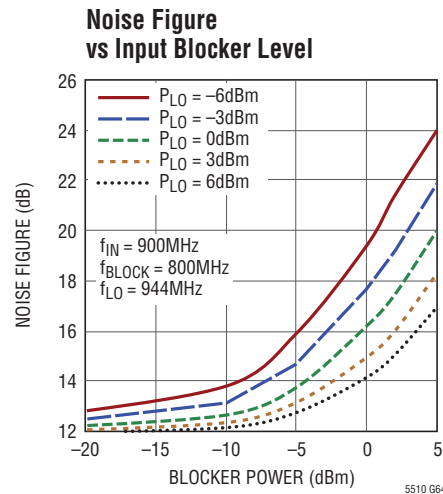
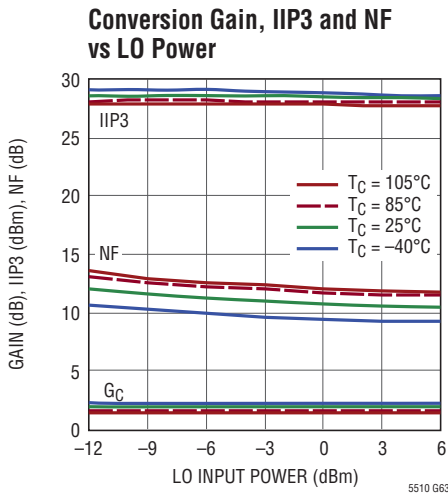
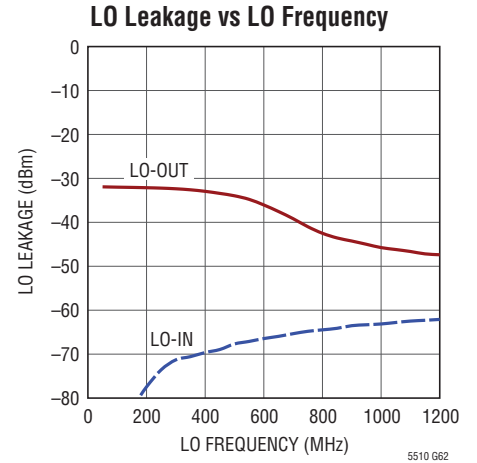
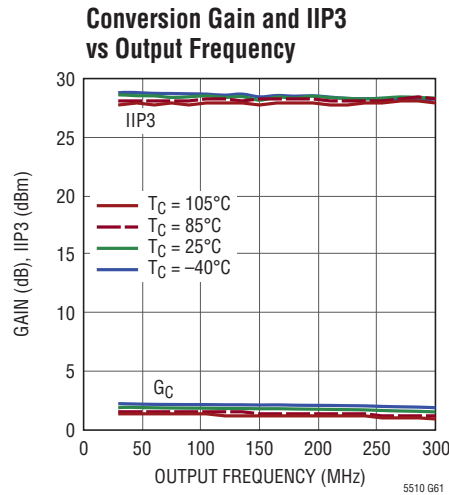
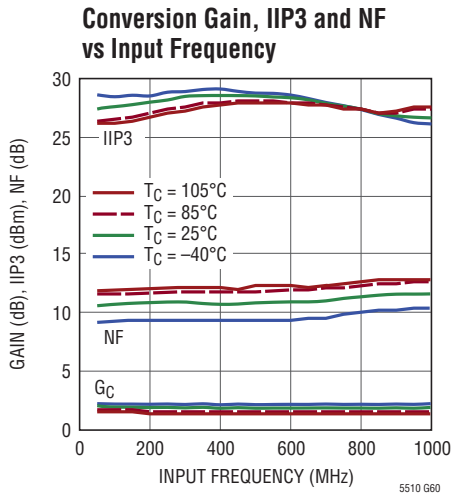

## PIN FUNCTIONS

**TEMP (Pin 1):** Temperature Monitor. This pin is connected to the anode of a diode through a  $30\Omega$  resistor. It may be used to measure the die temperature by forcing a current into the pin and measuring the voltage.

**IN<sup>+</sup>, IN<sup>-</sup> (Pins 2, 3):** Differential Signal Input. For optimum performance, these pins should be driven with a differential signal. The input can be driven single-ended, with some performance degradation, by connecting the undriven pin to RF ground through a capacitor. An internally generated 1.6V DC bias voltage is present on these pins, thus DC blocking capacitors are required.

**LGND (Pin 4):** DC Ground Return for the Input Amplifier. This pin must be connected to DC ground. The typical current from this pin is 64mA. In some applications an external chip inductor may be used. Note that any inductor DC resistance will reduce the current through this pin.

**EN (Pin 5):** Enable Pin. When the applied voltage is greater than 1.8V, the IC is enabled. Below 0.5V, the IC is disabled.

**V<sub>CC1</sub>, V<sub>CC2</sub> (Pins 6, 7):** Power Supply Pins for the Bias and LO Buffer Circuits. Typical current consumption is 41mA. These pins should be connected together on the circuit board and decoupled with a 10nF capacitor located close to the pins.

**I<sub>ADJ</sub> (Pin 8):** Bias Adjust Pin. This pin allows adjustment of the internal mixer current by adding an external pull-down resistor. The typical DC voltage on this pin is 1.8V. If not used, this pin must be left floating.

**GND (Pins 9, 12, 13, Exposed Pad (Pin 17)):** Ground. These pins must be soldered to the RF ground plane on the circuit board. The exposed metal pad of the package provides both electrical contact to ground and a good thermal contact to the printed circuit board.

**OUT<sup>-</sup>, OUT<sup>+</sup> (Pins 10, 11,):** Differential Output. These pins must be connected to a DC supply through impedance matching inductors and/or a transformer center-tap. Typical DC current consumption is 32mA into each pin.

**LO<sup>-</sup>, LO<sup>+</sup> (Pins 14, 15):** Differential Local Oscillator Input. A single-ended LO may be used by connecting one pin to RF ground through a DC blocking capacitor. These pins are internally biased to 1.7V; thus, DC blocking capacitors are required. Each LO input pin is internally matched to  $50\Omega$  for both EN states.

**TP (Pin 16):** Test Pin. This pin is used for production test purposes only and must be connected to ground.

## BLOCK DIAGRAM

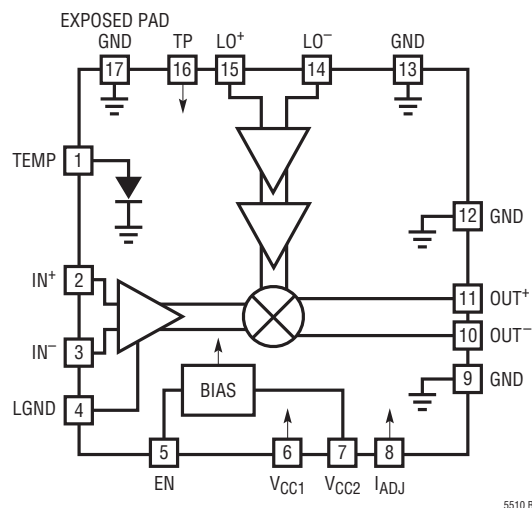

TEST CIRCUITS

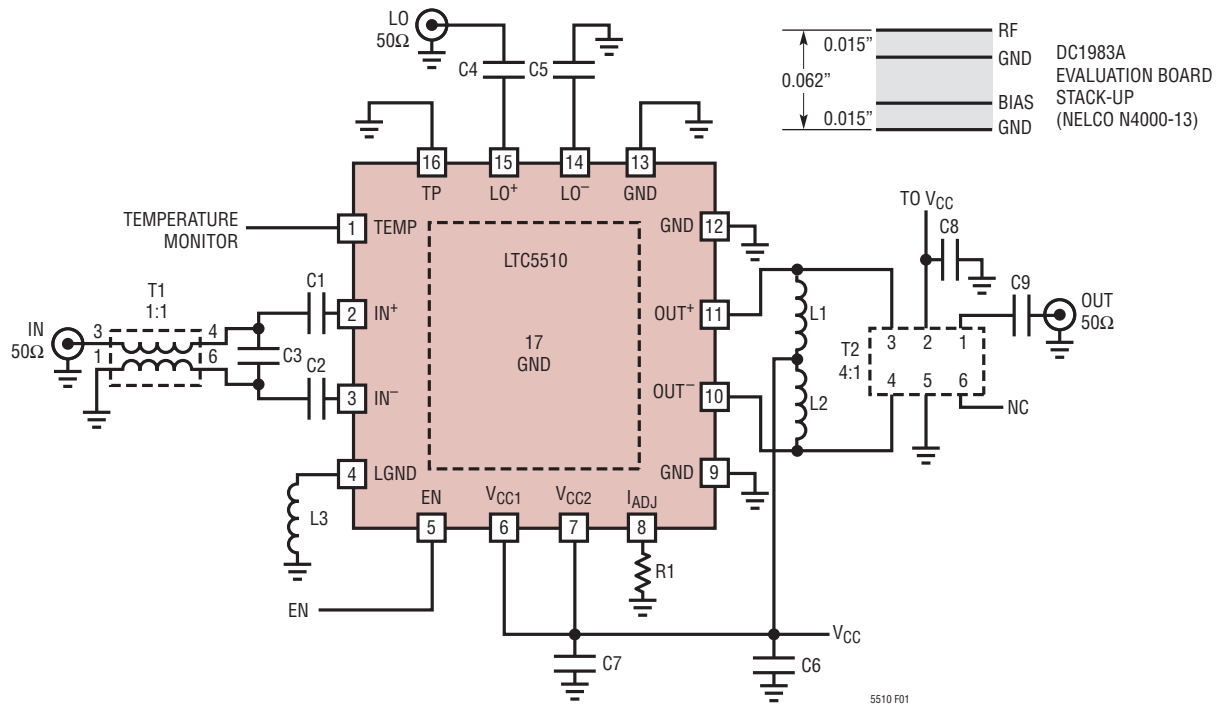

REF DES	5V/3.3V Wideband Up/Downmixer* $f_{IN} = 30\text{MHz}-3000\text{MHz}$ $f_{OUT} = 1575\text{MHz}$	5V Wideband Upmixer $f_{IN} = 30\text{MHz}-2500\text{MHz}$ $f_{OUT} = 2140\text{MHz}$	SIZE	COMMENTS
C1, C2, C4, C5	0.1 $\mu\text{F}$	0.1 $\mu\text{F}$	0402	Murata GRM15, X7R
C3	0.7pF	-	0402	Murata GJM15, C0G
C6	1 $\mu\text{F}$	1 $\mu\text{F}$	0603	Murata GRM18, X7R
C7, C8	10nF	10nF	0402	Murata GRM15, X7R
C9	6.8pF	5.6pF	0402	Murata GJM15, C0G
L1, L2	6.8nH	5.6nH	0402	CoilCraft 0402HP
L3	0 $\Omega$	0 $\Omega$	0603	
R1	4.75k $\Omega$ (5V), 1.8k $\Omega$ (3.3V)	4.75k $\Omega$	0402	1%
T1	Mini-Circuits TC1-1-13M+	Mini-Circuits TC1-1-13M+		
T2	Anaren BD1222J50200AHF	Mini-Circuits NCS4-232+		

\*Standard DC1983A Eval Board Configuration

Figure 1. High Frequency Output Test Circuit Schematic (DC1983A)

## TEST CIRCUITS

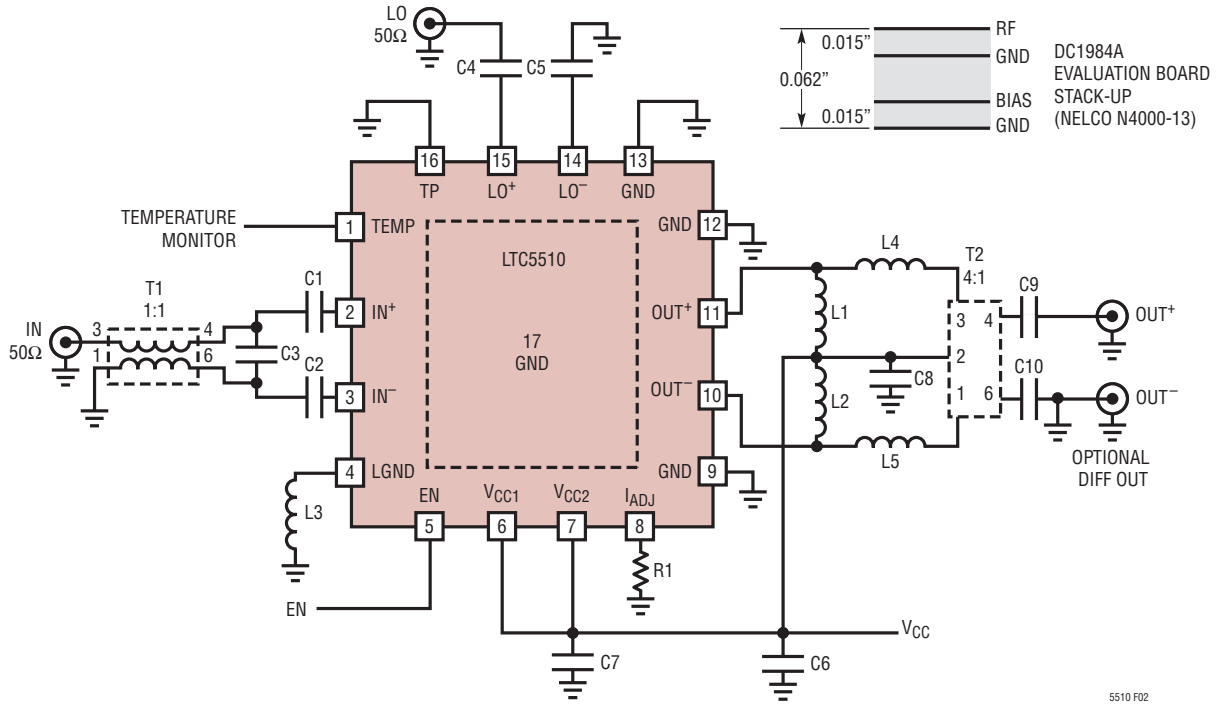

	5V VHF/UHF Upmixer*	5V VHF/UHF Wideband Downmixer		
REF DES	$f_{IN} = 70\text{MHz}$ $f_{OUT} = 100\text{MHz}-1000\text{MHz}$	$f_{IN} = 100\text{MHz}-1000\text{MHz}$ $f_{OUT} = 44\text{MHz}$	SIZE	COMMENTS
C1, C2, C4, C5	0.1 $\mu\text{F}$	0.1 $\mu\text{F}$	0402	Murata GRM15, X7R
C3	0.5pF	0.9pF	0402	Murata GJM15, C0G
C6	1 $\mu\text{F}$	1 $\mu\text{F}$	0603	Murata GRM18, X7R
C7, C8, C9, C10	10nF	10nF	0402	Murata GRM15, X7R
L1, L2	-	-	0603	
L3	220nH	0 $\Omega$	0603	Coilcraft 0603HP, WE 744761
L4, L5	15nH	0 $\Omega$	0402	CoilCraft 0402HP
R1	-	-	0402	
T1	Mini-Circuits TC1-1-13M+	Mini-Circuits TC1-1-13M+		
T2	Mini-Circuits TC4-19LN+	Mini-Circuits TC4-1W-7ALN+		

\*Standard DC1984A Eval Board Configuration

Figure 2. Low Frequency Output Test Circuit Schematic (DC1984A)



## APPLICATIONS INFORMATION

The LTC5510 uses wideband high performance RF and LO amplifiers driving a double-balanced mixer core to achieve frequency up- or down-conversion with high linearity over a very broad frequency range. For flexibility, all ports are differential; however, the LO port has also been optimized for single-ended use. Low side or high side LO injection can be used. The IN port may also be driven single-ended, though with some reduction in performance.

See the Pin Functions and Block Diagram sections for a description of each pin. Test circuit schematics showing all

external components required for the data sheet specified performance are shown in Figures 1 and 2. The evaluation boards are shown in Figures 3a and 3b.

The High Frequency Output test circuit, shown in Figure 1, utilizes a multilayer chip balun to realize a single-ended output. The Low Frequency Output test circuit in Figure 2 uses a wire-wound balun and is designed to accommodate a differential output if desired. Both the IN and LO ports are very broadband and use the same configurations for both test circuits. Additional components may be used to modify the DC supply current or frequency response, which will be discussed in the following sections.

### IN Port Interface

A simplified schematic of the mixer's input is shown in Figure 4a. The IN<sup>+</sup> and IN<sup>-</sup> pins drive the bases of the input transistors while internal resistors are used for impedance matching. These pins are internally biased to a common mode voltage of 1.6V, thus external capacitors C1 and C2 are required for DC isolation and can be used for impedance matching. A small value of C3 can be used to improve the impedance match at high frequencies and may improve noise figure. The 1:1 transformer, T1, provides single-ended to differential conversion for optimum performance.

The typical return loss at the IN port is shown in Figure 5 with 0.1 $\mu$ F at C1 and C2. The performance is better than 12dB up to 2.6GHz without C3. Adding a capacitance of 0.7pF at C3 extends the impedance match to 3GHz.

Differential input impedances (parallel equivalent) for various frequencies are listed in Table 1. At frequencies below 30MHz additional external components may be needed to optimize the input impedance. Figure 4b shows an equivalent circuit that can be used for single-ended or differential impedance matching at frequencies below 1GHz. Above 1GHz, the S-parameters should be used.

The DC bias current of the input amplifier flows through Pin 4 (LGND). Typically this pin should be directly connected to a good RF ground; however, at lower input frequencies it may be beneficial to insert an inductor to ground for improved IP2 performance. The inductor should have low resistance and must be rated to handle 64mA DC current.

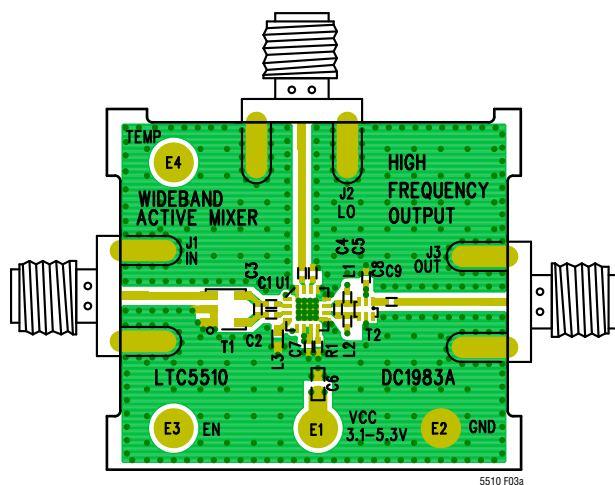

3a. High Frequency Output Board (DC1983A)

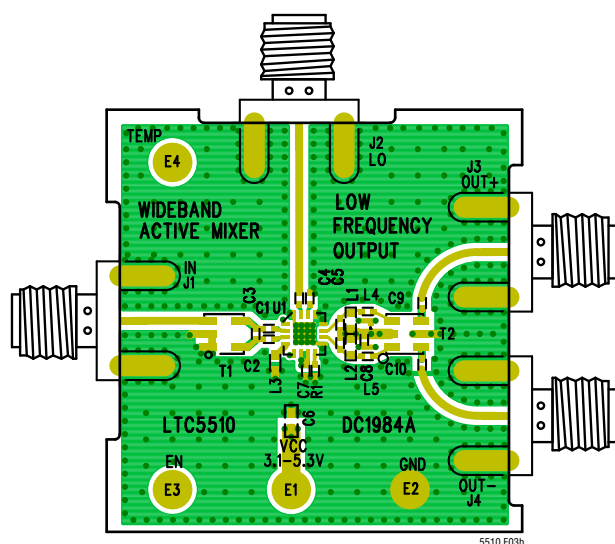

3b. Low Frequency Output Board (DC1984A)

Figure 3. LTC5510 Evaluation Board Layouts

## APPLICATIONS INFORMATION

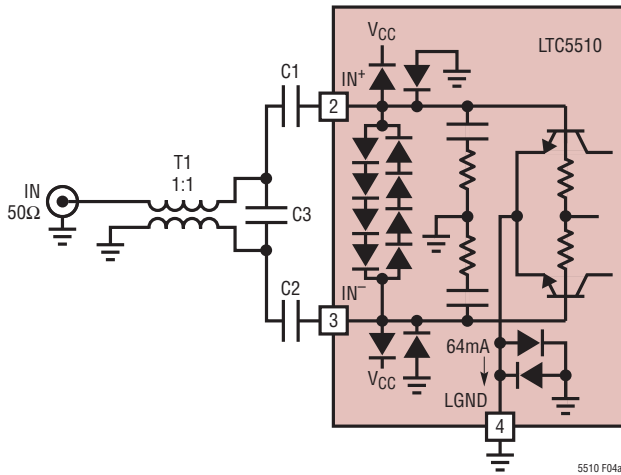

Figure 4a. IN Port with External Matching

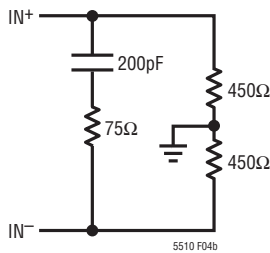

Figure 4b. IN Port Equivalent Circuit (< 1GHz)

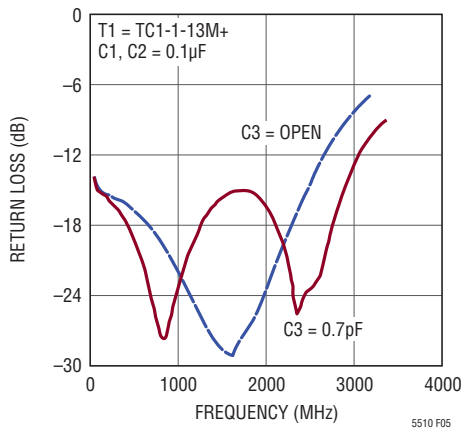

Figure 5. IN Port Return Loss

Table 1. IN Port Differential Impedance

FREQUENCY (MHz)	IMPEDANCE ( $\Omega$ )		REFL. COEFF.	
	REAL*	IMAG*	MAG	ANG ( $^\circ$ )
0.2	823	-j3971	0.89	-1.4
1	751	-j800	0.88	-7.2
10	133	-j154	0.50	-41
30	78.1	-j248	0.25	-36
50	73.3	-j378	0.20	-27
100	71.3	-j665	0.18	-17
200	70.7	-j961	0.17	-12
500	70.0	-j832	0.17	-14
1000	67.9	-j509	0.16	-24
1200	66.7	-j439	0.16	-28
1500	64.6	-j367	0.15	-35
2000	60.4	-j302	0.13	-49
2200	58.5	-j289	0.12	-55
2500	55.5	-j280	0.11	-66
3000	50.6	-j303	0.08	-91
4000	42.9	-j7460	0.08	-178
5000	42.7	j155	0.17	126
6000	55.9	j89	0.29	96

\*Parallel Equivalent Impedance

### LO Input Interface

The LTC5510 can be driven by a single-ended or differential LO signal. Internal resistors, as shown in Figure 6, provide an impedance match of  $50\Omega$  per side or  $100\Omega$  differential. The impedance match is maintained when the part is disabled as well. The LO input pins are internally biased to 1.7V, thus external capacitors, C4 and C5 are used to provide DC isolation.

## APPLICATIONS INFORMATION

The measured return loss of the LO input port is shown in Figure 7 for C4 and C5 values of 0.1  $\mu$ F. The return loss is better than 10dB from 5MHz to 6GHz. For frequencies below 5MHz, larger C4 and C5 values are required. Table 2 lists the single-ended input impedance and reflection coefficient versus frequency for the LO input. The differential impedance is listed in Table 3.

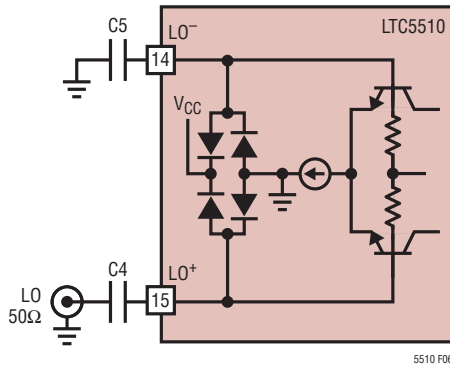

Figure 6. LO Input Circuit

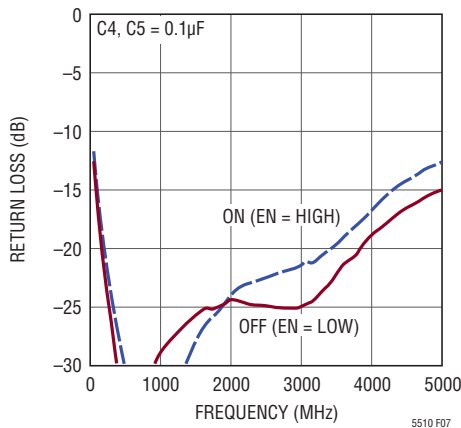

Figure 7. Single-Ended LO Input Return Loss

Table 2. Single-Ended LO Input Impedance

FREQUENCY (MHz)	IMPEDANCE ( $\Omega$ )		REFL. COEFF.	
	REAL	IMAG	MAG	ANG ( $^\circ$ )
1	90.3	-1.0	0.29	-1
10	87.5	-7.1	0.28	-8
100	55.3	-16.4	0.16	-63
600	47.8	-5.0	0.06	-111
1100	47.0	-4.7	0.06	-119
1600	46.2	-5.0	0.06	-124
2100	45.2	-5.1	0.07	-130
2600	44.2	-4.7	0.08	-138
3100	43.2	-3.9	0.08	-148
3600	42.3	-2.4	0.09	-161
4100	41.5	-0.3	0.09	-178
4500	40.8	2.0	0.10	166
5000	40.1	5.6	0.13	147
6000	38.6	14.3	0.20	120
6500	37.7	19.1	0.25	110

Table 3. Differential LO Input Impedance

FREQUENCY (MHz)	IMPEDANCE ( $\Omega$ )		REFL. COEFF.	
	REAL	IMAG	MAG	ANG ( $^\circ$ )
1	94.9	-0.1	0.31	-0.1
10	95.3	-0.5	0.31	-0.4
100	94.8	-2.3	0.31	-2
600	91.7	-12.5	0.31	-12
1100	85.6	-20.1	0.30	-21
1600	78.4	-24.2	0.29	-30
2100	71.5	-25.4	0.27	-38
2600	65.7	-24.3	0.24	-45
3100	61.3	-21.7	0.22	-51
3600	58.2	-17.9	0.18	-56
4100	56.2	-13.3	0.14	-58
4500	55.2	-9.1	0.10	-55
5000	54.6	-2.9	0.05	-31
6000	54.0	11.0	0.11	64
6500	53.7	18.5	0.18	69

## APPLICATIONS INFORMATION

### OUT Port Interface

The differential output interface is shown in Figure 8. The OUT<sup>+</sup> and OUT<sup>-</sup> pins are open collector outputs with internal load resistors that provide a 245Ω differential output resistance at low frequencies.

Figure 9 shows the equivalent circuit of the output and Table 4 lists differential impedances for various frequencies. The impedance values are listed in parallel equivalent form, with equivalent capacitances also shown. For optimum single-ended performance, the differential output signal must be combined through an external transformer or a discrete balun circuit. In applications where differential filters or amplifiers follow the mixer, it is possible to eliminate the transformer and drive these components differentially.

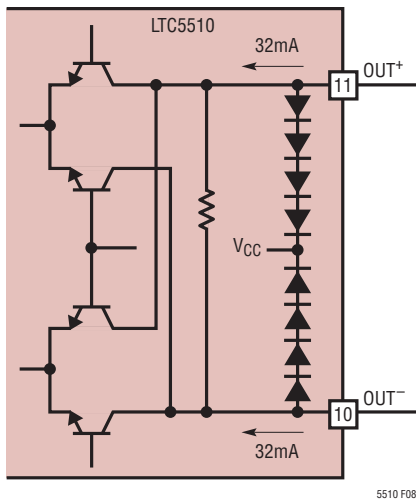

Figure 8. Output Interface

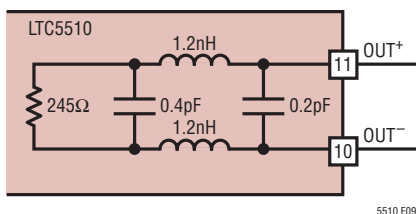

Figure 9. Output Port Equivalent Circuit

### Output Matching: High Frequency Output Board

The high frequency (HF) output evaluation board (DC1983A) shown in Figure 3a is designed to use multilayer chip hybrid baluns at the output. This board is intended for frequencies above about 800MHz (limited by balun availability). These baluns deliver good performance and are smaller than wire-wound baluns. The board is configured for the matching topology shown in Figure 10. Inductors L1 and L2 are used to tune out the parasitic output capacitance, while the transformer provides differential to single-ended conversion and impedance transformation. The DC bias to the mixer core can be applied through the matching inductors. Each pin draws approximately 32mA of DC supply current.

Table 4. Differential OUT Port Impedance

FREQUENCY (MHz)	IMPEDANCE (Ω)		REFL. COEFF.	
	REAL*	IMAG* (CAP)	MAG	ANG
1	245	-j240k (0.67pF)	0.66	0.0
10	244	-j40k (0.40pF)	0.66	-0.2
50	244	-j5.31k (0.60pF)	0.66	-1.1
100	245	-j2.66k (0.60pF)	0.66	-2.3
300	243	-j884 (0.60pF)	0.66	-6.8
500	240	-j529 (0.60pF)	0.66	-11
1000	224	-j260 (0.61pF)	0.65	-23
1500	201	-j169 (0.63pF)	0.63	-35
2000	171	-j122 (0.65pF)	0.60	-48
2500	138	-j93 (0.69pF)	0.57	-62
3000	104	-j73 (0.73pF)	0.53	-78
3500	73	-j59 (0.77pF)	0.48	-97
4000	47	-j51 (0.78pF)	0.43	-120
4500	29	-j59 (0.60pF)	0.39	-148
5000	22	j4.74K	0.38	180
6000	49	j51	0.44	117

\* Parallel Equivalent

## APPLICATIONS INFORMATION

Capacitor C9 can be used to improve the impedance match. The component values used for characterization are listed in Table 5, along with the 12dB return loss bandwidths. The measured return loss curves are plotted in Figure 11.

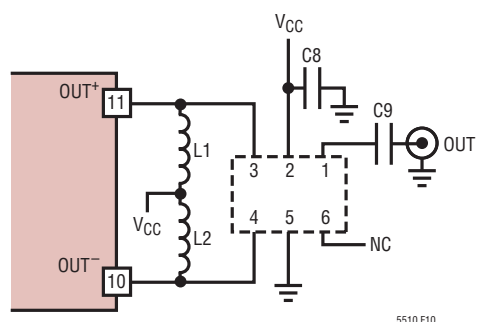

Figure 10. HF Board Output Schematic

Table 5. OUT Port Component Values: HF Output Board (DC1983A)

FREQUENCY (MHz)	RANGE* (GHz)	L1, L2 (nH)	C9 (pF)	T2
1575	1.2 to 2.1	6.8	6.8	Anaren BD1222J50200AHF
2140	1.6 to 2.5	5.6	5.6	Mini-Circuits NCS4-232+

\* 12dB Return Loss Bandwidth

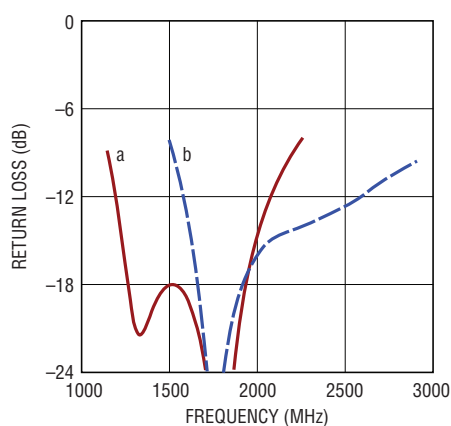

Figure 11. Out Port Return Loss of HF Board (DC1983A). Tuned for 1575MHz (a), and 2140MHz (b)

### Output Matching: Low Frequency Output Board

For lower output frequencies, wire-wound transformers provide better performance. The low frequency (LF) evaluation board (DC1984A) in Figure 3(b) accommodates these applications. The output matching topology is shown in Figure 12. Components L1, L2, L4 and L5 are used to tune the impedance match, while T2 provides the desired impedance transformation. C9 and C10 are used for DC blocking in some applications. Table 6 lists component values used for characterization, and the measured return loss performance is plotted in Figure 13.

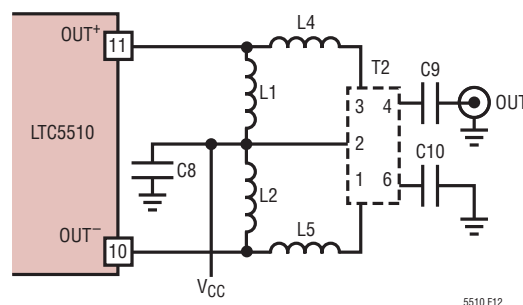

Figure 12. LF Board Output Schematic

Table 6. OUT Port Component Values: LF Output Board (DC1984A)

FREQUENCY (MHz)	RANGE* (MHz)	L1, L2 (nH)	L4, L5 (nH)	T2
44	5 to 325	-	0Ω	Mini-Circuits TC4-1W-7ALN+
456	10 to 1300	-	15	Mini-Circuits TC4-19LN+

\* 12dB Return Loss Bandwidth

APPLICATIONS INFORMATION

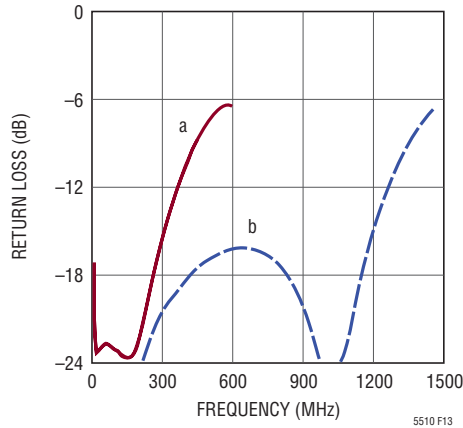

Figure 13. Out Port Return Loss of LF Board (DC1984A) Tuned for 44MHz (a), and 456MHz (b)

DC and RF Grounding

The LTC5510 relies on the backside ground for both RF and thermal performance. The exposed pad must be soldered to the low impedance top side ground plane of the board. The top side ground should also be connected to other ground layers to aid in thermal dissipation and ensure a low inductance RF ground. The LTC5510 evaluation boards (Figures 3a and 3b) utilize a 4 × 4 array of vias under the exposed pad for this purpose.

Enable Interface

Figure 14 shows a schematic of the EN pin interface. To enable the part, the applied EN voltage must be greater than 1.8V. Setting the voltage below 0.5V will disable the IC. If the enable function is not required, the enable pin can be connected to V<sub>CC</sub> through a 1k resistor. The ramp-up time of the supply voltage should be greater than 1ms. The voltage at the enable pin should never exceed the power supply voltage (V<sub>CC</sub>) by more than 0.3V. Under no circumstances should voltage be applied to the enable pin before the supply voltage is applied to the V<sub>CC</sub> pin. If this occurs, damage to the IC may result.

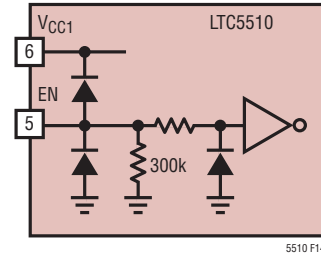

Figure 14. Enable Pin Interface

Current Adjust Pin (I<sub>ADJ</sub>)

The I<sub>ADJ</sub> pin (Pin 8) can be used to optimize the performance of the mixer core over temperature. The nominal open-circuit DC voltage on this pin is 1.8V and the typical short-circuit current is 1.9mA. As shown in Figure 15, an internal 4mA reference sets the current in the mixer core. Connecting resistor R1 to the I<sub>ADJ</sub> pin shunts some of the reference current to ground, thus reducing the mixer core current. The optimum value of R1 depends on the supply voltage and intended output frequency. Some recommended values are shown in Table 7, but the values can be optimized as required for individual applications.

Table 7. Recommended Values for R1

V <sub>CC</sub> (V)	f <sub>OUT</sub> (MHz)	R1 (Ω)	I <sub>CC</sub> (mA)
5	<1200	Open	105
5	>1200	4.75k	99
3.3	<1200	1k	90
3.3	>1200	1.8k	94

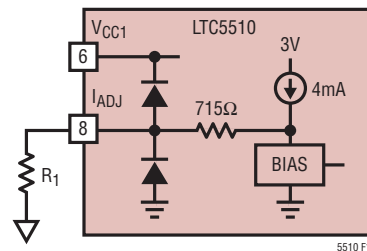

Figure 15. Current Adjust Pin Interface

## APPLICATIONS INFORMATION

### Temperature Monitor (TEMP)

The TEMP input (pin 1) is connected to an on-chip diode that can be used as a coarse temperature monitor by forcing current into it and measuring the resulting voltage. The temperature diode is protected by a series 30Ω resistor and additional ESD diodes to ground.

The TEMP pin voltage is shown as a function of junction temperature in Figure 16. Given the voltage (in mV) at the pin,  $V_D$ , the junction temperature can be estimated for forced input currents of 10μA and 80μA using the following equations:

$$T_J (10\mu\text{A}) = (V_D - 742.4) / -1.796$$

$$T_J (80\mu\text{A}) = (V_D - 795.6) / -1.609$$

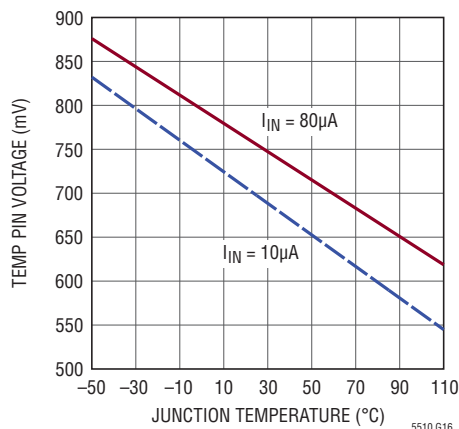

Figure 16. TEMP Pin Voltage vs Junction Temperature

### Auto Supply Voltage Detect

An internal circuit automatically detects the supply voltage and configures internal components for 3.3V or 5V operation. The DC current is affected when the auto-detect circuit switches at approximately 4.1V. To avoid undesired operation, the mixer should only be operated in the 3.1V to 3.6V or 4.5V to 5.3V supply ranges.

### Supply Voltage Ramping

Fast ramping of the supply voltage can cause a current glitch in the internal ESD protection circuits. Depending on the supply inductance, this could result in a supply voltage transient that exceeds the maximum rating. A supply voltage ramp time of greater than 1ms is recommended.

The ramp rate of the supply voltage at the  $V_{CC}$  pins should not exceed 20V/ms. If the EN and  $V_{CC}$  pins are switched simultaneously, the configuration in Figure 17 can be used to slow the rise time at the  $V_{CC}$  pins if needed.

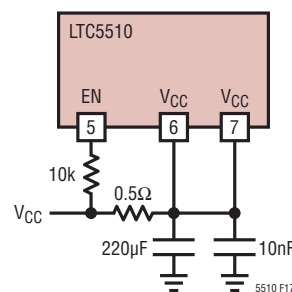

Figure 17. Suggested Configuration for Simultaneous  $V_{CC}$  and EN Switching

### Spurious Output Levels

Mixer spurious output levels versus harmonics of the IN and LO frequencies are tabulated in Tables 8 and 9 for the 5V Wideband Up/Downmixer application. Results are shown for frequencies up to 15GHz. The spur frequencies can be calculated using the following equation:

$$f_{\text{SPUR}} = |M \cdot f_{\text{IN}} \pm N \cdot f_{\text{LO}}|$$

Table 8 shows the “difference” spurs ( $f_{\text{SPUR}} = |M \cdot f_{\text{IN}} - N \cdot f_{\text{LO}}|$ ) and Table 9 shows the “sum” spurs ( $f_{\text{SPUR}} = M \cdot f_{\text{IN}} + N \cdot f_{\text{LO}}$ ). The spur levels were measured on a standard evaluation board at room temperature using the test circuit shown in Figure 1. The spurious output levels for each application will be dependent on the external matching circuits and the particular application frequencies.

## APPLICATIONS INFORMATION

**Table 8. Output Spur Levels (dBc),  $f_{SPUR} = |M \cdot f_{IN} - N \cdot f_{LO}|$   
( $f_{IN} = 190\text{MHz}$  at  $-7\text{dBm}$ ,  $f_{LO} = 1765\text{MHz}$  at  $0\text{dBm}$ ,  $V_{CC} = 5\text{V}$ )**

		N									
		0	1	2	3	4	5	6	7	8	
M	0	-	-30	-30	-40	-18	-44	-4	-46	-24	
	1	-64	0**	-50	-30	-64	-22	-55	-47	-72	
	2	*	-37	-73	-65	-65	-58	-49	-72	-59	
	3	*	-48	*	-71	*	-66	-79	-75	-86	
	4	*	-68	*	-83	*	-84	*	*	*	
	5	*	-77	*	-84	*	-87	*	*	*	
	6	*	-89	*	-87	*	*	*	*	*	
	7	*	*	*	-86	*	*	*	*	*	
	8	*	*	*	-84	*	*	*	*	*	
	9	*	*	*	*	*	*	*	*	*	
	10	*	*	*	*	*	*	*	*	*	

\* Less Than  $<-90\text{dBc}$

\*\*Carrier Frequency

**Table 9. Output Spur Levels (dBc),  $f_{SPUR} = M \cdot f_{IN} + N \cdot f_{LO}$   
( $f_{IN} = 190\text{MHz}$  at  $-7\text{dBm}$ ,  $f_{LO} = 1765\text{MHz}$  at  $0\text{dBm}$ ,  $V_{CC} = 5\text{V}$ )**

		N									
		0	1	2	3	4	5	6	7	8	
M	0	-	-30	-30	-40	-18	-44	-4	-46	-24	
	1	-64	-0.4**	-50	-16	-55	-26	-52	-52	-69	
	2	*	-36	-73	-50	-63	-59	-46	-76	-62	
	3	*	-49	-88	-65	*	-72	-74	-84	-81	
	4	*	-66	*	-84	-90	*	-79	*	*	
	5	*	-70	*	*	*	*	*	*	*	
	6	*	-73	*	*	*	*	*	*	*	
	7	*	-75	*	*	*	*	*	*	*	
	8	*	-74	*	*	*	*	*	*	*	
	9	*	-80	*	*	*	*	*	*	*	
	10	*	*	*	*	*	*	*	*	*	

\* Less Than  $<-90\text{dBc}$

\*\*Image Frequency



# TYPICAL APPLICATIONS

## Upmixer with 3.3GHz to 3.8GHz Output

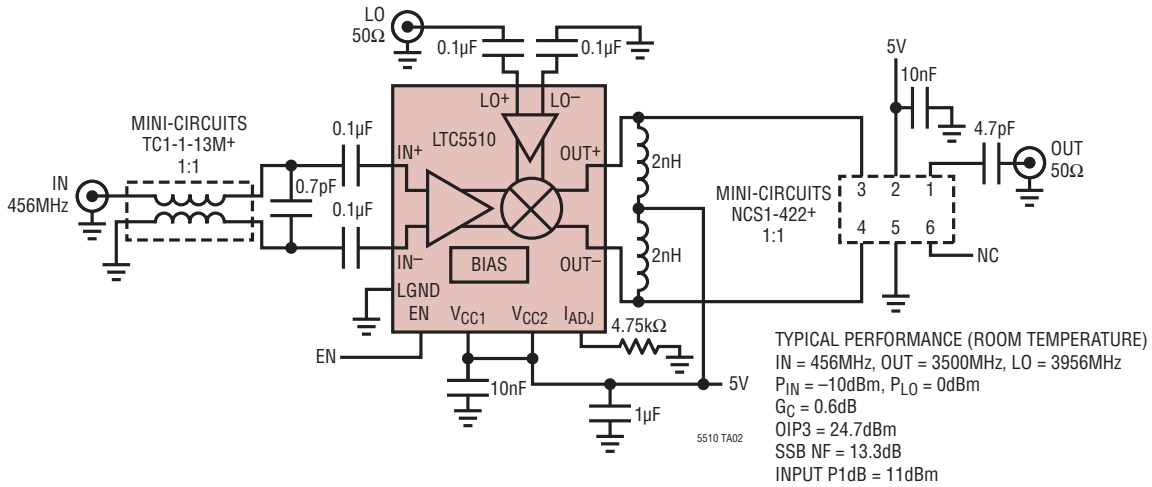

**Conversion Gain, OIP3 and NF vs Output Frequency**

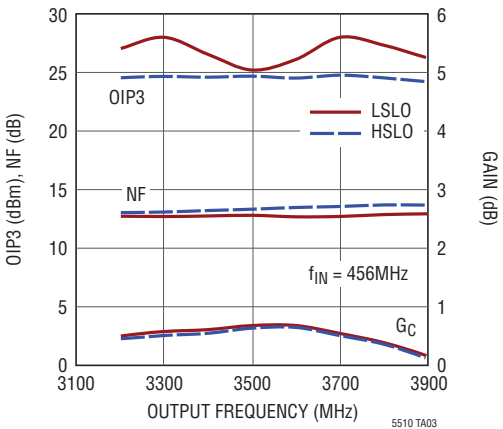

**Conversion Gain and OIP3 vs Input Frequency**

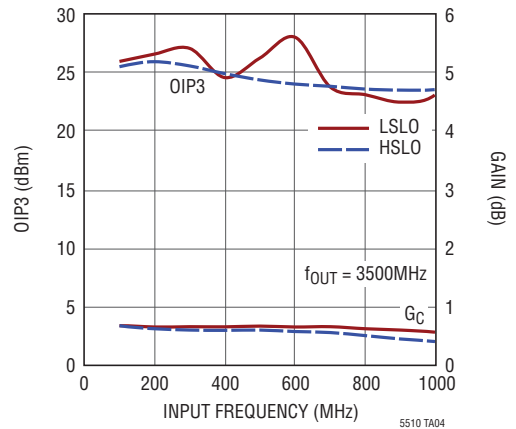

**IN Isolation and LO Leakage vs Frequency**

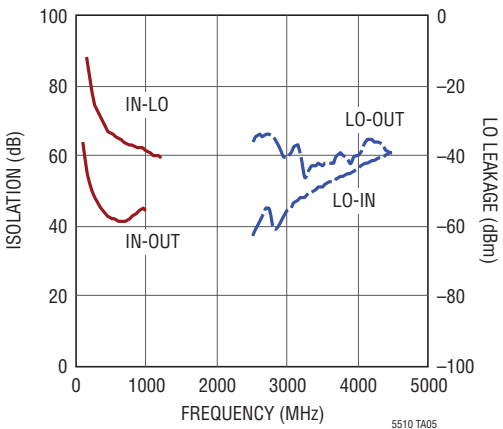

**IN, OUT and LO Port Return Loss vs Frequency**

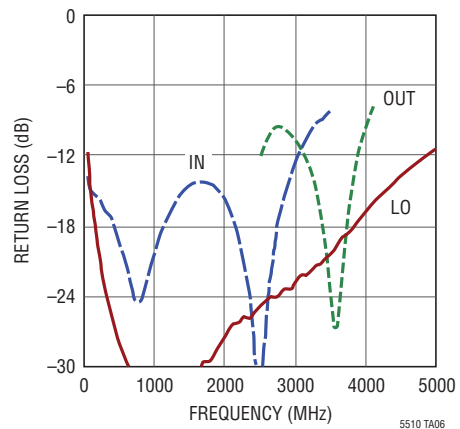

5510fa

## TYPICAL APPLICATIONS

### Mixer with Extended Input Frequency Range to 6GHz

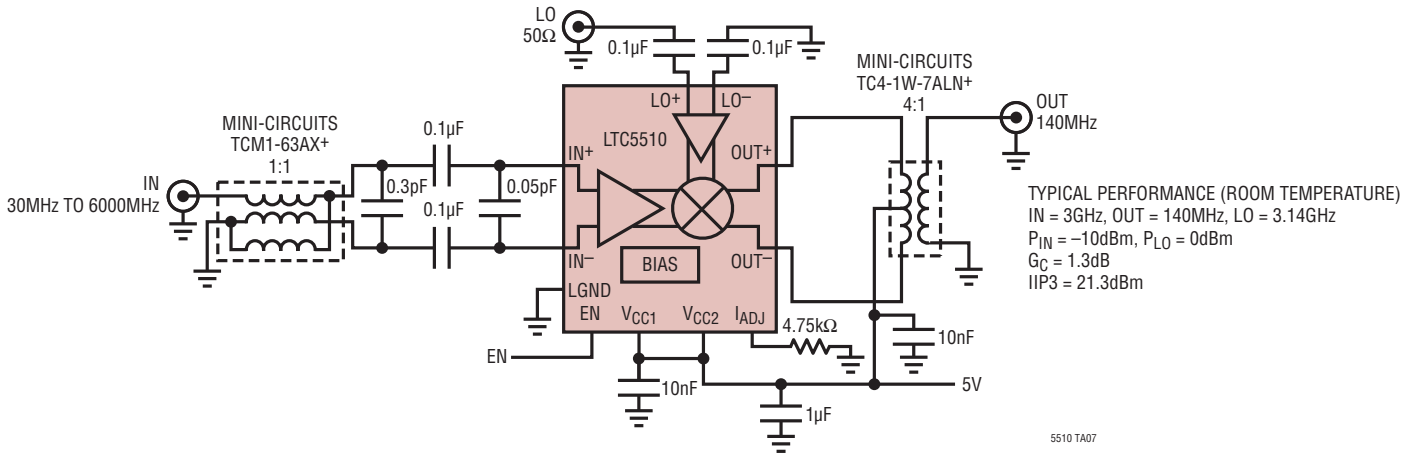

### Conversion Gain and IIP3 vs Input Frequency

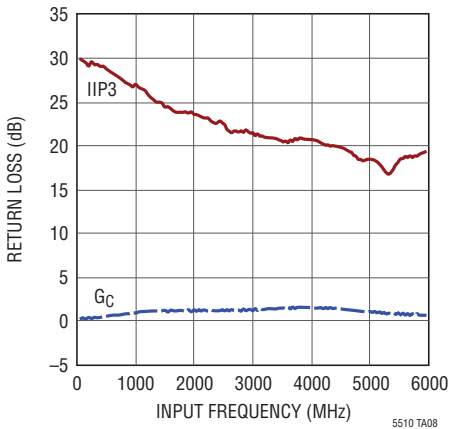

### LO-OUT Leakage and IN-OUT Isolation vs Frequency

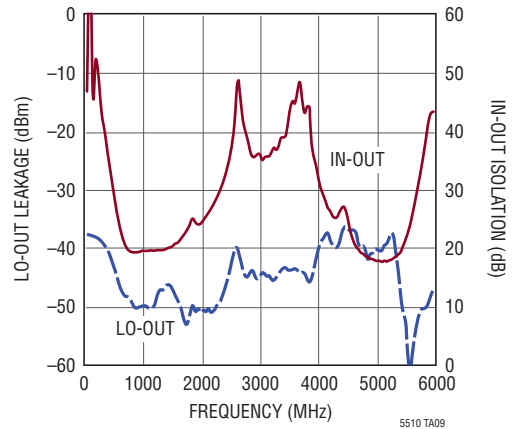

### IN PORT and LO PORT Return Loss vs Frequency

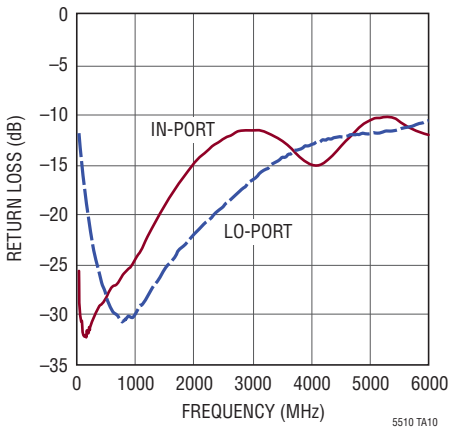

### OUT PORT Return Loss vs Frequency

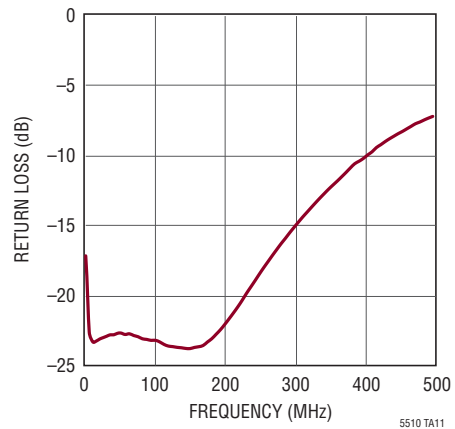

# TYPICAL APPLICATIONS

## Broadband Downmixer Application Using Single-Ended Input

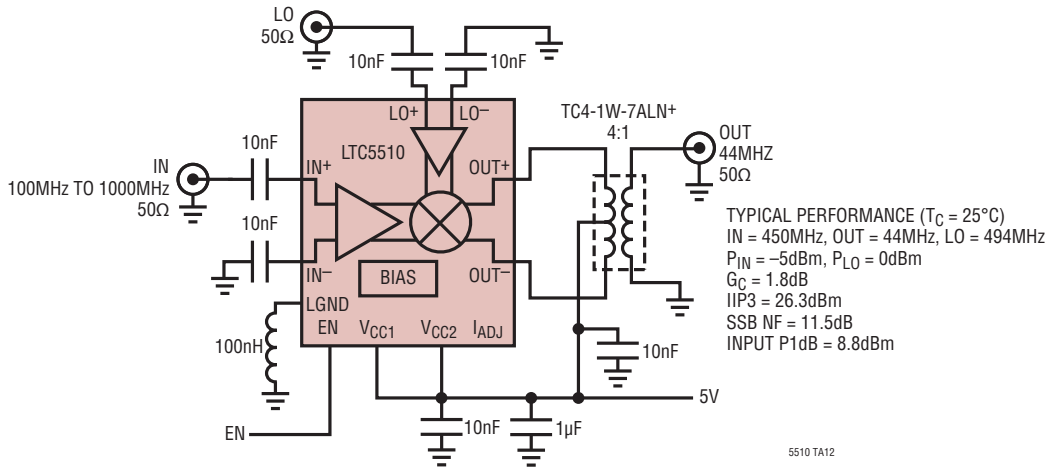

Conversion Gain, IIP3 and NF vs Input Frequency

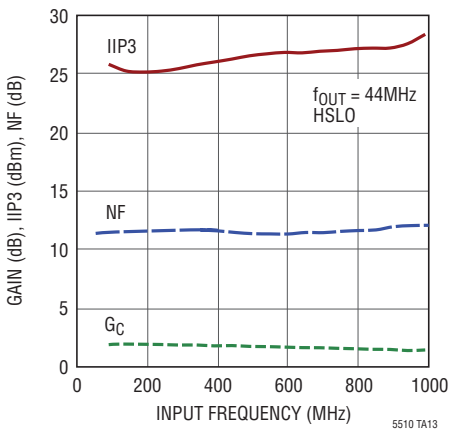

Conversion Gain and IIP3 vs Output Frequency

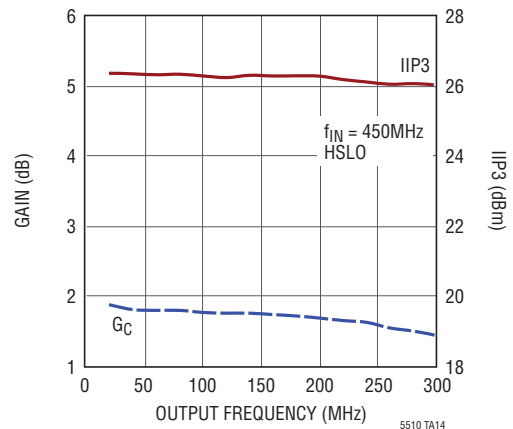

LO Leakage and IN Isolation vs Frequency

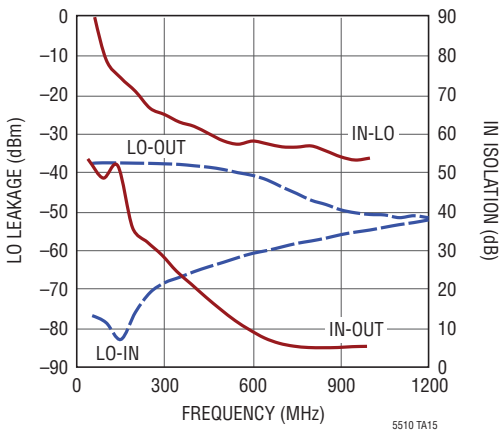

IN, OUT and LO Port Return Loss vs Frequency

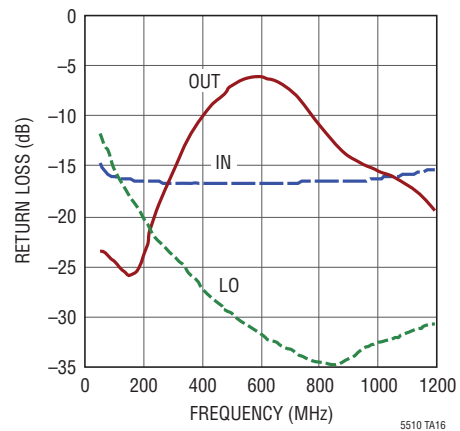

5510fa

# PACKAGE DESCRIPTION

Please refer to <http://www.linear.com/designtools/packaging/> for the most recent package drawings.

## UF Package 16-Lead Plastic QFN (4mm × 4mm) (Reference LTC DWG # 05-08-1692 Rev 0)

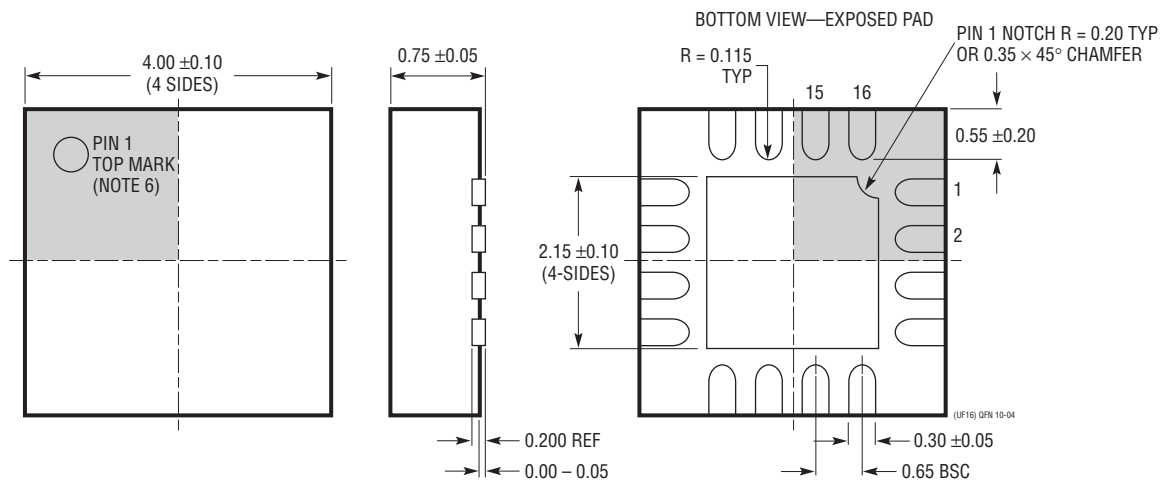
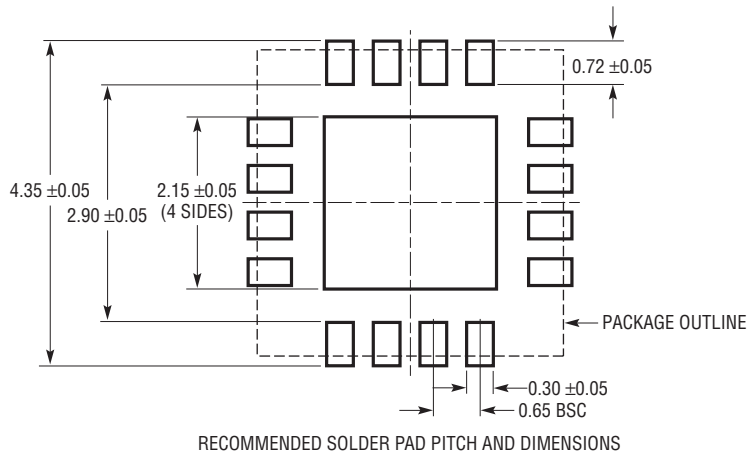

- NOTE:
1. DRAWING CONFORMS TO JEDEC PACKAGE OUTLINE MO-220 VARIATION (WGGC)
  2. DRAWING NOT TO SCALE
  3. ALL DIMENSIONS ARE IN MILLIMETERS
  4. DIMENSIONS OF EXPOSED PAD ON BOTTOM OF PACKAGE DO NOT INCLUDE MOLD FLASH. MOLD FLASH, IF PRESENT, SHALL NOT EXCEED 0.15mm ON ANY SIDE
  5. EXPOSED PAD SHALL BE SOLDER PLATED
  6. SHADED AREA IS ONLY A REFERENCE FOR PIN 1 LOCATION ON THE TOP AND BOTTOM OF PACKAGE

## REVISION HISTORY

REV	DATE	DESCRIPTION	PAGE NUMBER
A	06/15	LO and OUTPUT frequency range increased to 6500 and 6000MHz, respectively.  Corrected Figure 4 caption.	2, 19, 20, 22, 23, 26  22

## TYPICAL APPLICATION

5V CATV Downmixer with 1GHz IF Bandwidth

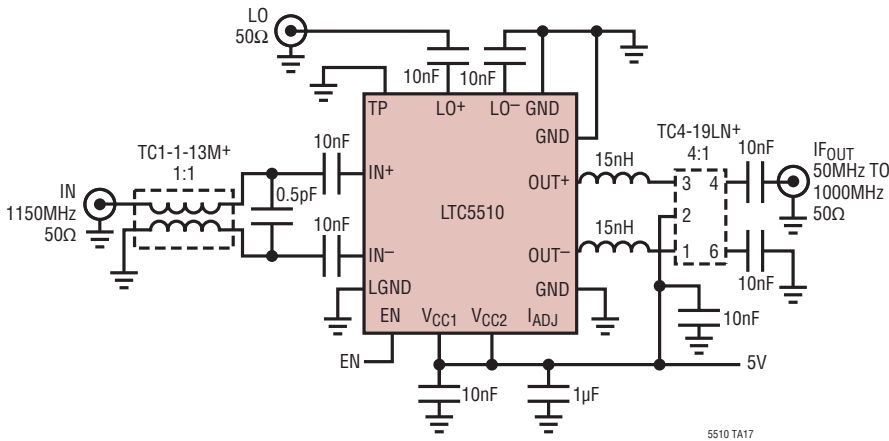

Conversion Gain, OIP3 and 2RF-LO Spur vs IF Output Frequency

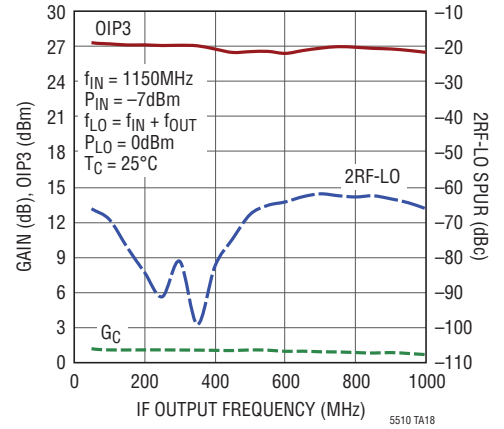

## RELATED PARTS

PART NUMBER	DESCRIPTION	COMMENTS
<b>Mixers and Modulators</b>		
<a href="#">LT<sup>®</sup>5527</a>	400MHz to 3.7GHz, 5V Downconverting Mixer	2.3dB Gain, 23.5dBm IIP3 and 12.5dB NF at 1900MHz, 5V/78mA Supply
<a href="#">LT5557</a>	400MHz to 3.8GHz, 3.3V Downconverting Mixer	2.9dB Gain, 24.7dBm IIP3 and 11.7dB NF at 1950MHz, 3.3V/82mA Supply
<a href="#">LTC559x</a>	600MHz to 4.5GHz Dual Downconverting Mixer Family	8.5dB Gain, 26.5dBm IIP3, 9.9dB NF, 3.3V/380mA Supply
<a href="#">LTC5569</a>	300MHz to 4GHz, 3.3V Dual Active Downconverting Mixer	2dB Gain, 26.8dBm IIP3 and 11.7dB NF, 3.3V/180mA Supply
<a href="#">LTC554x</a>	600MHz to 4GHz, 5V Downconverting Mixer Family	8dB Gain, >25dBm IIP3 and 10dB NF, 3.3V/200mA Supply
<a href="#">LT5578</a>	400MHz to 2.7GHz Upconverting Mixer	27dBm OIP3 at 900MHz, 24.2dBm at 1.95GHz, Integrated RF Output Transformer
<a href="#">LT5579</a>	1.5GHz to 3.8GHz Upconverting Mixer	27.3dBm OIP3 at 2.14GHz, NF = 9.9dB, 3.3V Supply, Single-Ended LO and RF Ports
<a href="#">LTC5588-1</a>	200MHz to 6GHz I/Q Modulator	31dBm OIP3 at 2.14GHz, -160.6dBm/Hz Noise Floor
<a href="#">LTC5585</a>	700MHz to 3GHz Wideband I/Q Demodulator	>530MHz Demodulation Bandwidth, IIP2 Tunable to >80dBm, DC Offset Nulling
<b>Amplifiers</b>		
<a href="#">LTC6430-15</a>	High Linearity Differential IF Amp	20MHz to 2GHz Bandwidth, 15.2dB Gain, 50dBm OIP3, 3dB NF at 240MHz
<a href="#">LTC6431-15</a>	High Linearity Single-Ended IF Amp	20MHz to 1.7GHz Bandwidth, 15.5dB Gain, 47dBm OIP3, 3.3dB NF at 240MHz
<a href="#">LTC6412</a>	31dB Linear Analog VGA	35dBm OIP3 at 240MHz, Continuous Gain Range -14dB to 17dB
<a href="#">LT5554</a>	Ultralow Distortion IF Digital VGA	48dBm OIP3 at 200MHz, 2dB to 18dB Gain Range, 0.125dB Gain Steps
<b>RF Power Detectors</b>		
<a href="#">LT5538</a>	40MHz to 3.8GHz Log Detector	±0.8dB Accuracy Over Temperature, -72dBm Sensitivity, 75dB Dynamic Range
<a href="#">LT5581</a>	6GHz Low Power RMS Detector	40dB Dynamic Range, ±1dB Accuracy Over Temperature, 1.5mA Supply Current
<a href="#">LTC5582</a>	40MHz to 10GHz RMS Detector	±0.5dB Accuracy Over Temperature, ±0.2dB Linearity Error, 57dB Dynamic Range
<a href="#">LTC5583</a>	Dual 6GHz RMS Power Detector	Up to 60dB Dynamic Range, ±0.5dB Accuracy Over Temperature, >50dB Isolation
<b>ADCs</b>		
<a href="#">LTC2208</a>	16-Bit, 130Msps ADC	78dBFS Noise Floor, >83dB SFDR at 250MHz
<a href="#">LTC2153-14</a>	14-Bit, 310Msps Low Power ADC	68.8dBFS SNR, 88dB SFDR, 401mW Power Consumption
<b>RF PLL/Synthesizer with VCO</b>		
<a href="#">LTC6946-1/ LTC6946-2/ LTC6946-3</a>	Low Noise, Low Spurious Integer-N PLL with Integrated VCO	373MHz to 5.79GHz, -157dBc/Hz WB Phase Noise Floor, -100dBc/Hz Closed-Loop Phase Noise

5510fa



Компания «ЭлектроПласт» предлагает заключение долгосрочных отношений при поставках импортных электронных компонентов на взаимовыгодных условиях!

Наши преимущества:

- Оперативные поставки широкого спектра электронных компонентов отечественного и импортного производства напрямую от производителей и с крупнейших мировых складов;
- Поставка более 17-ти миллионов наименований электронных компонентов;
- Поставка сложных, дефицитных, либо снятых с производства позиций;
- Оперативные сроки поставки под заказ (от 5 рабочих дней);
- Экспресс доставка в любую точку России;
- Техническая поддержка проекта, помощь в подборе аналогов, поставка прототипов;
- Система менеджмента качества сертифицирована по Международному стандарту ISO 9001;
- Лицензия ФСБ на осуществление работ с использованием сведений, составляющих государственную тайну;
- Поставка специализированных компонентов (Xilinx, Altera, Analog Devices, Intersil, Interpoint, Microsemi, Aeroflex, Peregrine, Syfer, Eurofarad, Texas Instrument, Miteq, Cobham, E2V, MA-COM, Hittite, Mini-Circuits, General Dynamics и др.);

Помимо этого, одним из направлений компании «ЭлектроПласт» является направление «Источники питания». Мы предлагаем Вам помощь Конструкторского отдела:

- Подбор оптимального решения, техническое обоснование при выборе компонента;
- Подбор аналогов;
- Консультации по применению компонента;
- Поставка образцов и прототипов;
- Техническая поддержка проекта;
- Защита от снятия компонента с производства.



#### Как с нами связаться

**Телефон:** 8 (812) 309 58 32 (многоканальный)

**Факс:** 8 (812) 320-02-42

**Электронная почта:** [org@eplast1.ru](mailto:org@eplast1.ru)

**Адрес:** 198099, г. Санкт-Петербург, ул. Калинина, дом 2, корпус 4, литера А.