

# General Specifications

## Electrical Capacity (Resistive Load)

**Power Level (silver):** 5A @ 125/250V AC or 5A @ 30V DC  
**Logic Level (gold):** 0.4VA maximum @ 28V AC/DC maximum  
 (Applicable Range 0.1mA ~ 0.1A @ 20mV ~ 28V)  
 Note: Find additional explanation of operating range in Supplement section.

## Other Ratings

**Contact Resistance:** 50 milliohms maximum for silver; 100 milliohms maximum for gold  
**Insulation Resistance:** 200 megohms minimum @ 500V DC  
**Dielectric Strength:** 1,000V AC minimum between contacts for 1 minute minimum;  
 1,500V AC minimum between contacts & case for 1 minute minimum  
**Mechanical Life:** 1,000,000 operations minimum for momentary;  
 200,000 operations minimum for alternate action  
**Electrical Life:** 10,000 operations minimum for silver;  
 200,000 operations minimum for gold  
**Nominal Operating Force:** Single Pole: 1.90N  
 Double Pole: 2.55N  
**Contact Timing:** Break before make  
**Travel:** Pretravel .067" (1.7mm); Overtravel .024" (0.6mm); Total Travel .091" (2.3mm)

## Materials & Finishes

**Housing/Bezel:** Glass fiber reinforced polyamide (UL94V-0)  
**Snap-in Frame:** Stainless steel  
**Movable Contactor:** Phosphor bronze  
**Movable Contacts:** Silver alloy or copper with gold plating  
**Stationary Contacts:** Silver alloy or copper with gold plating  
**Switch Terminals:** Phosphor bronze with silver or gold plating  
**Lamp Terminals:** Brass with tin plating  
**Base:** Glass fiber reinforced liquid crystal polymer (UL94V-0)

## Environmental Data

**Operating Temperature Range:** -25°C through +50°C (-13°F through +122°F) for Illuminated  
 -25°C through +70°C (-13°F through +158°F) for Nonilluminated  
**Humidity:** 90 ~ 95% humidity for 240 hours @ 40°C (104°F)  
**Vibration:** 10 ~ 55Hz with peak-to-peak amplitude of 1.5mm traversing the frequency range & returning in 1 minute; 3 right angled directions for 2 hours  
**Shock:** 50G (490m/s<sup>2</sup>) acceleration (tested in 6 right angled directions, with 5 shocks in each direction)

## Installation

**Cap Installation Force:** 15.0N maximum downward force on cap

## Processing

**Soldering:** Wave Soldering (PC version): See Profile A in Supplement section.  
 Manual Soldering: See Profile A in Supplement section.  
**Cleaning:** These devices are not process sealed. Hand clean locally using alcohol based solution.

## Standards & Certifications

**Flammability Standards:** UL94V-0 housing/bezel & base  
**UL:** **File No. E44145 - Recognized only when ordered with marking on switch.**  
 Add "/U" or "/CUL" before dash in part number to order UL recognized switch.  
 UL recognized only when ordered switch body with cap assembled.  
 All single & double pole models recognized at 5A @ 125/250V AC or 0.014A @ 28V DC.

# Distinctive Characteristics

Wide selection of illumination effects is achieved with single and bicolor, 1- or 6-element LEDs in flat, beveled, or sculptured caps.

Alternating legends (patent pending) in choice of sculptured or flat caps, combined with super bright bicolor LED.

Combination of PCB mountability and short body allows use in compact applications.

Small behind panel dimension for snap-in mounting in tight spaces.

Snap-acting contact mechanism provides sensitive actuation with audible feedback; quick-make, quick-break characteristic limits arcing and prolongs electrical life.

Latchdown mechanism, independent of switching mechanism, gives outstanding stability and reliability plus visible and tactile indication of circuit status.

Terminals are epoxy sealed to lock out flux, solvents, and other contaminants.

Momentary and alternate action circuits available in the same space-saving body size.

Matching indicators available.



Actual Size



- Toggles
- Rockers
- Pushbuttons
- D Illuminated PB**
- Programmable
- Keylocks
- Rotaries
- Slides
- Tactiles
- Tilt
- Touch
- Indicators
- Accessories
- Supplement

### TYPICAL SWITCH

### ORDERING EXAMPLE



#### IMPORTANT:



Switches are supplied without UL & cULus marking unless specified. **UL & cULus recognized only when ordered with marking on switch.** Specific models, ratings, & ordering instructions are noted on the General Specifications page.

#### DESCRIPTION FOR TYPICAL ORDERING EXAMPLE

**UB215SKG035C-1JC**



## POLES & CIRCUITS

Pole	Model	Plunger Position ( ) = Momentary		Connected Terminals		Throw & Switch/Lamp Schematics
		Normal	Down	Normal	Down	
SP	UB215 *UB216	ON ON	(ON) ON	1-3	1-2	Notes: Switch is marked with NC, NO, COM, L+ & L-. Lamp circuit is isolated and requires an external power source. 
DP	UB225 *UB226	ON ON	(ON) ON	1-3 4-6	1-2 4-5	

\* When in latchdown position for the alternate circuit, cap positions above the housing are:  
.059" (1.5mm) for snap-in models & .276" (7.0mm) for PCB models.

## MOUNTING TYPES & SHAPES

### PCB Mounting



**Square**

SP, Single Color LED

DP, Single Color LED

SP, Bicolor LED

DP, Bicolor LED

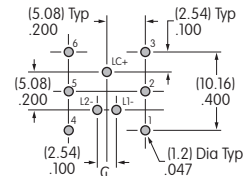
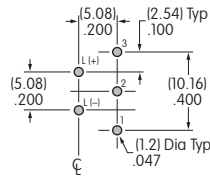

### Snap-in Mounting (Solder Lug)



**Square with Built-in Bezel**



Panel Thickness:  
.039 ~ .126"  
(1.0 ~ 3.2mm)

## CONTACT MATERIALS & RATINGS



**Silver Contacts**

**Power Level**

**5A @ 125V AC & 250V AC**



**Gold Contacts**

**Logic Level**

**0.4VA maximum @ 28V AC/DC maximum**

Complete explanation of operating range in Supplement section.

## SWITCH & LAMP TERMINALS



**Solder Lug**

For Switch & Bright LED

For Super Bright & Bicolor LED



**Straight PC**

For Switch & Bright LED

For Super Bright & Bicolor LED



## BRIGHT LED & CAPS

The electrical specifications shown are determined at a basic temperature of 25°C.  
 LED circuit is isolated and requires an external power source. Polarity marks are on the bottom of the switch.  
 If the source voltage exceeds the rated voltage, a ballast resistor is required.  
 The resistor value can be calculated by using the formula in the Supplement section.

The LED is an integral part of the switch and not available separately.

### Electrical Specifications for Bright LED

		<b>5C</b>	<b>5D</b>	<b>5F</b>	
	Color	Red	Amber	Green	Unit
Maximum Forward Current	$I_{FM}$	30	30	25	mA
Typical Forward Current	$I_F$	20	20	20	mA
Forward Voltage	$V_F$	1.85	2.0	2.1	V
Maximum Reverse Voltage	$V_{RM}$	5	5	5	V
Current Reduction Rate Above 25°C	$\Delta I_F$	0.40	0.42	0.46	mA/°C
Ambient Temperature Range		-25° ~ +50°			°C

Bright Single Color LED with 1 element



### Caps for Bright LED

#### 1 AT3074 Sculptured

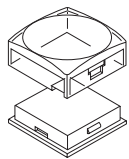

Clear Lens  
 Translucent Colored Diffuser

#### 2 AT3075 Beveled

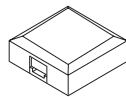

Translucent Colored Cap

#### 3 AT3076 Flat

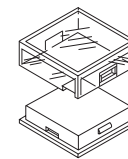
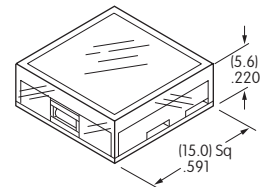

Clear Lens  
 Translucent Colored Diffuser

#### Lens/Diffuser Colors Available:

- JB** Clear/White
- JC** Clear/Red
- JD** Clear/Amber
- JF** Clear/Green

#### Cap Colors Available:

- B** White
- C** Red
- D** Amber
- F** Green

#### Lens/Diffuser Colors Available:

- JB** Clear/White
- JC** Clear/Red
- JD** Clear/Amber
- JF** Clear/Green

Material: Polycarbonate

Finish: Glossy

## SUPER BRIGHT LEDs & CAPS

The electrical specifications shown are determined at a basic temperature of 25°C.  
LED circuit is isolated and requires an external power source. Polarity marks are on the bottom of the switch.

If the source voltage exceeds the rated voltage, a ballast resistor is required.  
The resistor value can be calculated by using the formula in the Supplement section.

The LED is an integral part of the switch and not available separately.

### Electrical Specifications for Super Bright LEDs

Super Bright LEDs are Electrostatic Sensitive	ATTENTION ELECTROSTATIC SENSITIVE DEVICES	Color	6B	6F	6G	Unit
			White	Green	Blue	
Maximum Forward Current		$I_{FM}$	20	30	30	mA
Typical Forward Current		$I_F$	15	20	20	mA
Forward Voltage		$V_F$	3.3	3.5	3.6	V
Maximum Reverse Voltage		$V_{RM}$	5	5	5	V
Current Reduction Rate Above 25°C		$\Delta I_F$	0.25	0.50	0.50	mA/°C
Ambient Temperature Range			-20° ~ +50°			°C

Super Bright Single Color LED with 1 element



### Caps for Super Bright LED

**1JB** AT3074JB Sculptured Clear Lens/White Diffuser



**2B** AT3075B Beveled White Cap

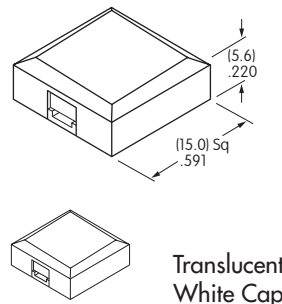

**3JB** AT3076JB Flat Clear Lens/White Diffuser



Material: Polycarbonate Finish: Glossy

## SUPER BRIGHT BICOLOR LED & CAPS

### Electrical Specifications for Super Bright Bicolor LED

The electrical specifications shown are determined at a basic temperature of 25°C. LED circuit is isolated and requires an external power source. Polarity marks are on bottom of switch. If the source voltage exceeds the rated voltage, a ballast resistor is required. The resistor value can be calculated by using the formula in Supplement Section. The LED is an integral part of the switch and not available separately.	Super Bright LEDs are Electrostatic Sensitive	ATTENTION ELECTROSTATIC SENSITIVE DEVICES	Color	6CF	Unit			
				Red/Green				
				Maximum Forward Current		$I_{FM}$	30/25 (25/22 for Amber)	mA
				Typical Forward Current		$I_F$	20/20	mA
				Forward Voltage		$V_F$	2.1/3.5	V
				Maximum Reverse Voltage		$V_{RM}$	4/4	V
				Current Reduction Rate Above 25°C		$\Delta I_F$	0.40/0.33	mA/°C
Ambient Temperature Range		-25° ~ +50°	°C					

Super Bright Bicolor LED with 2 elements



Amber color is achieved by lighting red and green simultaneously, but is not suitable for Alternating Legends.

## Caps for Super Bright Bicolor LED

**1JB** AT3074JB Sculptured Clear Lens/White Diffuser



**2B** AT3075B Beveled White Cap



**3JB** AT3076JB Flat Clear Lens/White Diffuser

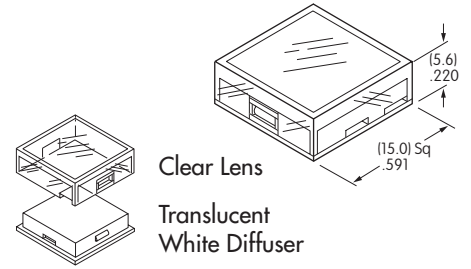

Material: Polycarbonate Finish: Glossy

## Alternating Legend Caps for Super Bright Bicolor LED

**4J** AT3069J Sculptured Cap with Alternating Legend



**5J** AT3070J Flat Cap with Alternating Legend



Material: Polycarbonate Finish: Glossy

## Standard Alternating Legend Pairs



Cap illumination is alternating green/red; legend text is black.  
Contact factory for other Alternating Legends.

Legend illustrations are approximate representations of the actual characters on the filters.

**No Code** No Lamp

## CAP TYPES & COLOR COMBINATIONS FOR NONILLUMINATED

**4** AT3073 Sculptured

Lens/Insert Colors Available:

- JA** Clear/Black
- JB** Clear/White
- JC** Clear/Red
- JD** Clear/Amber
- JF** Clear/Green

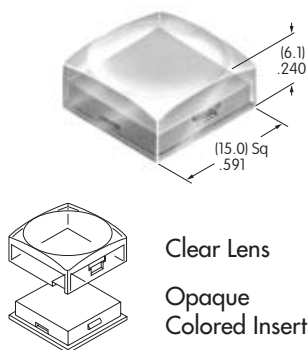

Material: Polycarbonate  
Finish: Glossy

**5** AT3077 Beveled

Cap Colors Available:

- A** Black
- B** White
- C** Red
- D** Amber
- F** Green

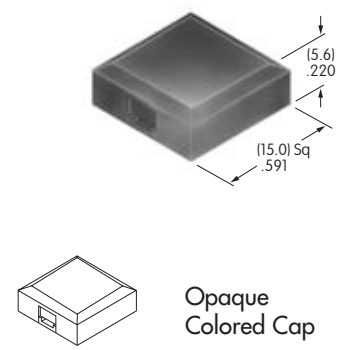

Material: Polycarbonate  
Finish: Glossy

## TYPICAL SWITCH DIMENSIONS

### Bright & Super Bright LED Straight PC



**UB215SKG035C-1JC**

Bright Single Color LED

Super Bright Single Color LED

Single Pole

Double Pole

### Bicolor LED Straight PC

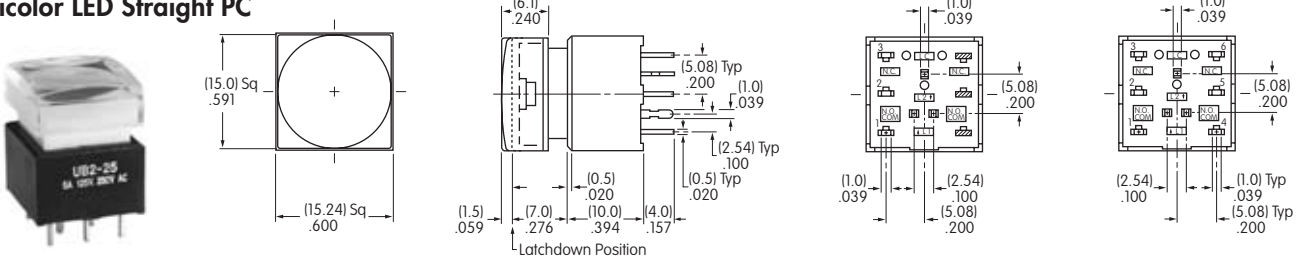

**UB225SKG03CF-1JB**

Bicolor LED Side View

Single Pole

Double Pole

### Bright LED Solder Lug



**UB216KKW015F-1JF**

Single Color LED Side View

Single Pole

Double Pole

### Super Bright LED Solder Lug

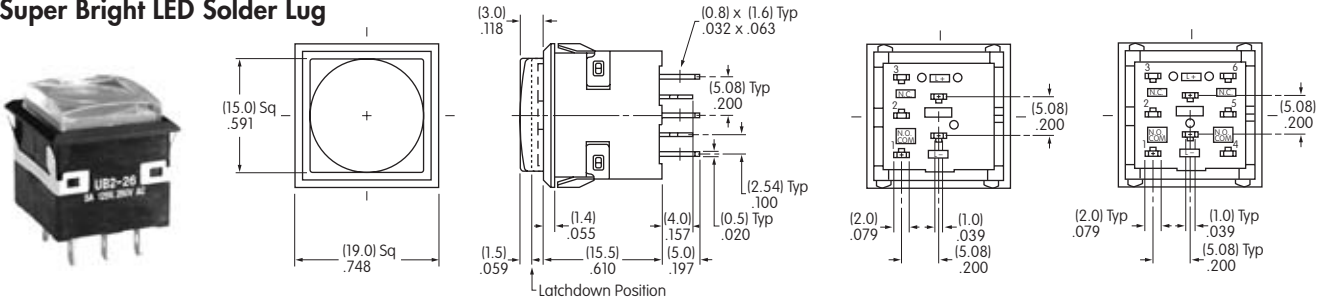

**UB226KKW016F-1JF**

Single Color LED Side View

Single Pole

Double Pole

### Bicolor LED Solder Lug

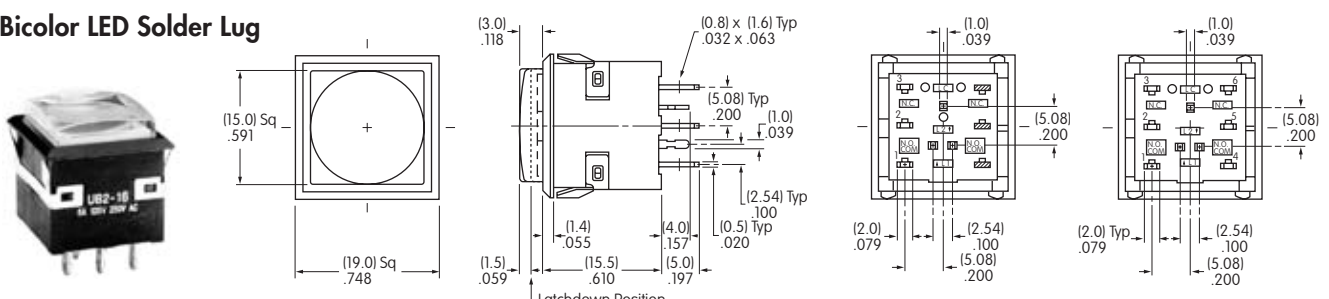

**UB216KKW01CF-1JB**

Bicolor LED Side View

Single Pole

Double Pole

Toggles

Rockers

Pushbuttons

Illuminated PB

Programmable

Keylocks

Rotaries

Slides

Tactiles

Tilt

Touch

Indicators

Accessories

Supplement



## OPTIONAL ACCESSORIES

### Protective Guard for Snap-in Model

#### AT4141

Opens 90°  
Closes manually



#### Materials:

Cover: Clear Polycarbonate  
Base: Black GFR Polyamide

**Recommended Panel Thickness:**  
.039" ~ .106" (1.0mm ~ 2.7mm)

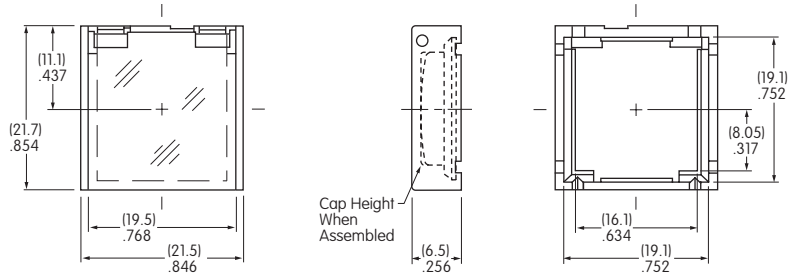

### Spring Loaded Protective Guard for Snap-in Mounting of PCB Model

#### AT4170

Opens 180°  
Closes automatically



#### Materials:

Cover: Clear Polycarbonate  
Base: Black Polyamide  
Coil Spring: Stainless Steel

**Recommended Panel Thickness:**  
.039" ~ .126"  
(1.0mm ~ 3.2mm)

**Recommended Panel-to-PCB Range:**  
.531" ~ .622"  
(13.5mm ~ 15.8mm)

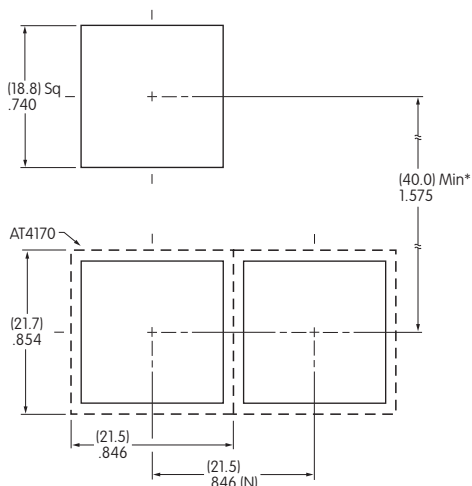
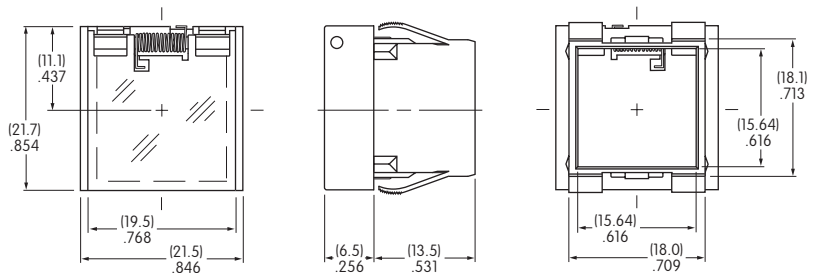

(N) = Number of switches

\* Minimum dimension allows opening of cover to 180°



#### Installation

- 1 Install switch onto PC board.
- 2 Snap protective guard into panel.
- 3 Join the two assemblies.

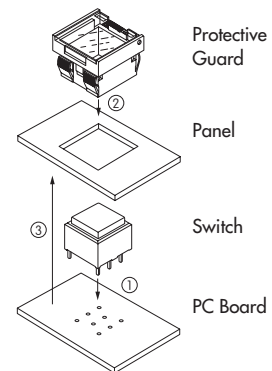

## OPTIONAL ACCESSORIES

### Spring Loaded Protective Guard for Snap-in Model

#### AT4142

Opens 180°  
Closes automatically



#### Materials:

Cover: Clear Polycarbonate  
Base: Black GFR Polyamide  
Coil Spring: Stainless Steel

#### Recommended Panel Thickness:

.039" ~ .106" (1.0mm ~ 2.7mm)

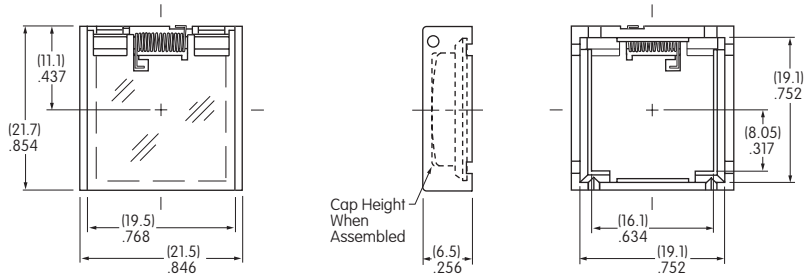

### Dust Cover

AT4145 Not for use with barriers.

#### Materials:

Lid: Clear PVC  
Operating temperature range:  
0°C ~ +70°C (32°F ~ 158°C).  
Gasket: Polyethylene



#### Recommended Panel Thickness

.039" ~ .098" (1.0mm ~ 2.5mm)

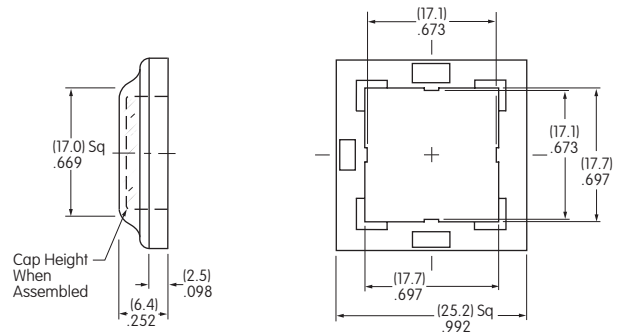

### Barriers for Snap-in Mount

#### AT4143 End

#### AT4144 Center

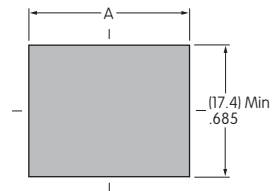
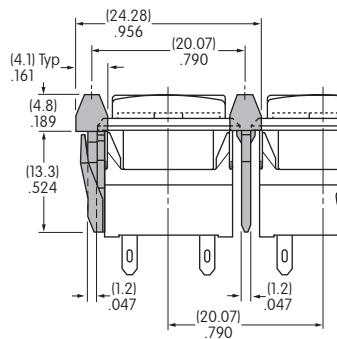
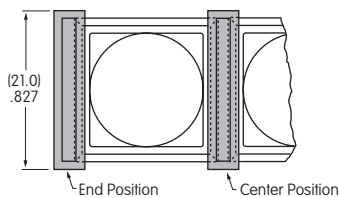

Cutouts for more than 1 Switch:

$$A = .799" (20.3\text{mm}) \times \text{Number of Switches} + .051" (1.3\text{mm})$$

Material: Polyamide

LEGENDS

NKK Switches can provide custom legends for caps. Contact factory for more information.

Suggested Printable Area for UB2 Lens, Film Insert or Diffuser

Recommended Methods: Laser Etch on clear lens, Screen Print or Pad Print on lens;  
Laser Print on film insert.

Shaded areas are printable areas.

Beveled Cap



Flat Cap

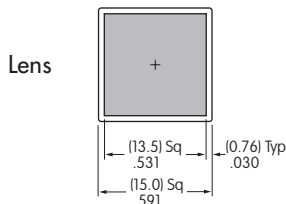

Film Insert or Diffuser

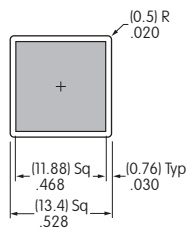

Sculptured Cap

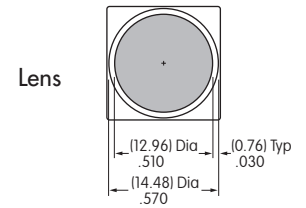

Film Insert or Diffuser

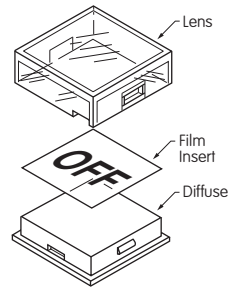

Film Insert: Clear Polyester 4 mil maximum thickness

Toggles

Rockers

Pushbuttons

Illuminated PB

Programmable

Keylocks

Rotaries

Slides

Tactiles

Tilt

Touch

Indicators

Accessories

Supplement



Компания «ЭлектроПласт» предлагает заключение долгосрочных отношений при поставках импортных электронных компонентов на взаимовыгодных условиях!

Наши преимущества:

- Оперативные поставки широкого спектра электронных компонентов отечественного и импортного производства напрямую от производителей и с крупнейших мировых складов;
- Поставка более 17-ти миллионов наименований электронных компонентов;
- Поставка сложных, дефицитных, либо снятых с производства позиций;
- Оперативные сроки поставки под заказ (от 5 рабочих дней);
- Экспресс доставка в любую точку России;
- Техническая поддержка проекта, помощь в подборе аналогов, поставка прототипов;
- Система менеджмента качества сертифицирована по Международному стандарту ISO 9001;
- Лицензия ФСБ на осуществление работ с использованием сведений, составляющих государственную тайну;
- Поставка специализированных компонентов (Xilinx, Altera, Analog Devices, Intersil, Interpoint, Microsemi, Aeroflex, Peregrine, Syfer, Eurofarad, Texas Instrument, Miteq, Cobham, E2V, MA-COM, Hittite, Mini-Circuits, General Dynamics и др.);

Помимо этого, одним из направлений компании «ЭлектроПласт» является направление «Источники питания». Мы предлагаем Вам помощь Конструкторского отдела:

- Подбор оптимального решения, техническое обоснование при выборе компонента;
- Подбор аналогов;
- Консультации по применению компонента;
- Поставка образцов и прототипов;
- Техническая поддержка проекта;
- Защита от снятия компонента с производства.



#### Как с нами связаться

**Телефон:** 8 (812) 309 58 32 (многоканальный)

**Факс:** 8 (812) 320-02-42

**Электронная почта:** [org@eplast1.ru](mailto:org@eplast1.ru)

**Адрес:** 198099, г. Санкт-Петербург, ул. Калинина, дом 2, корпус 4, литера А.