

DATA SHEET

SMV1705 Series: Hyperabrupt Junction Tuning Varactors

Applications

- Low-noise and wideband UHF and VHF VCOs
- High volume, low-cost batteries

Features

- Low series resistance
- High capacitance ratio
- Packages rated MSL1, 260 °C per JEDEC J-STD-020





Skyworks Green™ products are compliant with all applicable legislation and are halogen-free. For additional information, refer to *Skyworks Definition of Green™*, document number SQ04-0074.

Description

The SMV1705 group of silicon hyperabrupt junction varactor diodes is specifically designed for battery operation. The specified high capacitance ratio and low reverse voltage of these varactors make them appropriate for low-noise voltage controlled oscillators (VCOs) used at frequencies in wireless systems up to and above 10 GHz.

Table 1 describes the various packages and markings of the SMV1705 group of varactors.

Table 1. Packaging and Marking

		
Common Cathode	Single	Single
SOT-23	SC-79 Green™	SOD-882 Green™
SMV1705-004LF Green™ Marking: HY3	SMV1705-079LF Marking: Cathode and YE	SMV1705-040LF Marking: 0
Ls = 1.4 nH	Ls = 0.7 nH	Ls = 0.45 nH



The Pb-free symbol or "LF" in the part number denotes a lead-free, RoHS-compliant package unless otherwise noted as Green™. Tin/lead (Sn/Pb) packaging is not recommended for new designs.

Electrical and Mechanical Specifications

The absolute maximum ratings of the SMV1705 group of varactors are provided in Table 2. Electrical specifications are provided in Table 3. Typical capacitance values are listed in Table 4. Typical performance characteristics of the SMV1705 varactors are illustrated in Figures 1 and 2.

The SPICE model for the SMV1705 varactors is shown in Figure 3 and the associated model parameters are provided in Table 5.

Package Dimensions

Package dimensions are shown in Figures 4 to 8 (even numbers), and tape and reel dimensions are provided in Figures 5 to 9 (odd numbers).

Package and Handling Information

Instructions on the shipping container label regarding exposure to moisture after the container seal is broken must be followed. Otherwise, problems related to moisture absorption may occur when the part is subjected to high temperature during solder assembly.

The SMV1705 series of varactors are rated to Moisture Sensitivity Level 1 (MSL1) at 260 °C. They can be used for lead or lead-free soldering. For additional information, refer to the Skyworks Application Note, *Solder Reflow Information*, document number 200164.

Care must be taken when attaching this product, whether it is done manually or in a production solder reflow environment. Production quantities of this product are shipped in a standard tape and reel format.

Table 2. SMV1705 Series Absolute Maximum Ratings¹

Parameter	Symbol	Minimum	Maximum	Units
Reverse voltage	V _R		12	V
Forward current	I _F		20	mA
Power dissipation	P _{DIS}		250	mW
Operating temperature	T _{OP}	-55	+125	°C
Storage temperature	T _{STG}	-55	+150	°C
Electrostatic discharge:	ESD			
Charged Device Model (CDM), Class 3			1000	V
Human Body Model (HBM), Class 1C			1000	V
Machine Model (MM), Class B			200	V

¹ Exposure to maximum rating conditions for extended periods may reduce device reliability. There is no damage to device with only one parameter set at the limit and all other parameters set at or below their nominal value. Exceeding any of the limits listed here may result in permanent damage to the device.

ESD HANDLING: *Although this device is designed to be as robust as possible, electrostatic discharge (ESD) can damage this device. This device must be protected at all times from ESD when handling or transporting. Static charges may easily produce potentials of several kilovolts on the human body or equipment, which can discharge without detection. Industry-standard ESD handling precautions should be used at all times.*

Table 3. SMV1705 Series Electrical Specifications¹
(T_{OP} = 25 °C, Unless Otherwise Noted)

Parameter	Symbol	Test Condition	Min	Typical	Max	Units
Reverse current	I _R	V _R = 8 V		<0.01	20	nA
Capacitance	C _T	F = 1 MHz : V _R = 1 V	17.3	18.3	19.3	pF
		V _R = 4 V	5.3	6.1	6.6	pF
Capacitance ratio	C _{TR}	C _T @ 1 V / C _T @ 4 V	2.8	3.0		–
Series resistance	R _S	F = 470 MHz, V _R = 1 V		0.32		Ω
Breakdown voltage	V _{BR}	I _R = 10 μA	12			V

¹ Performance is guaranteed only under the conditions listed in this table.

Table 4. Capacitance vs Reverse Voltage

V_R (V)	C_T (pF)
0	31.5
0.5	23.5
1.0	18.3
1.5	14.3
2.0	11.9
2.5	9.7
3.0	8.3
3.5	7.1
4.0	6.1
4.5	5.5
5.0	5.2

Typical Performance Characteristics

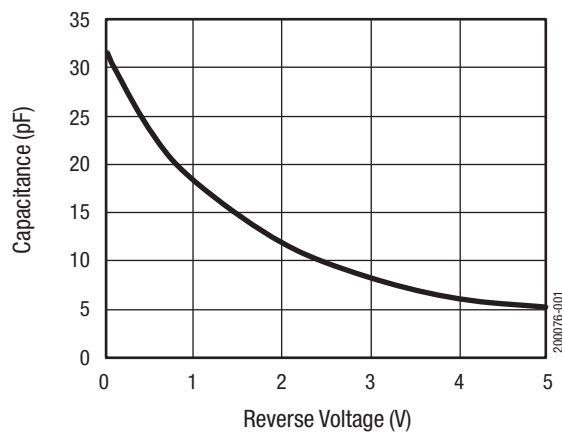

Figure 1. Capacitance vs Reverse Voltage

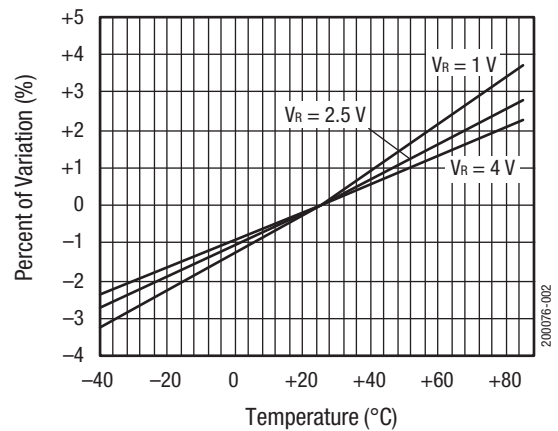

Figure 2. Relative Capacitance Change vs Temperature

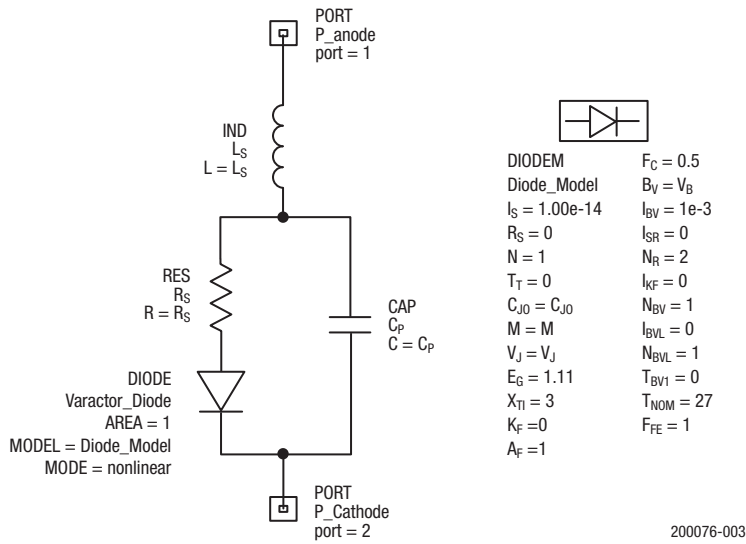

Figure 3. SPICE Model

Table 5. SPICE Model Parameters

Part Number	CJO (pF)	VJ (V)	M	CP (pF)	Rs (Ω)	Ls (nH)
SMV1705	31	3	2	0.5	0.32	0.8

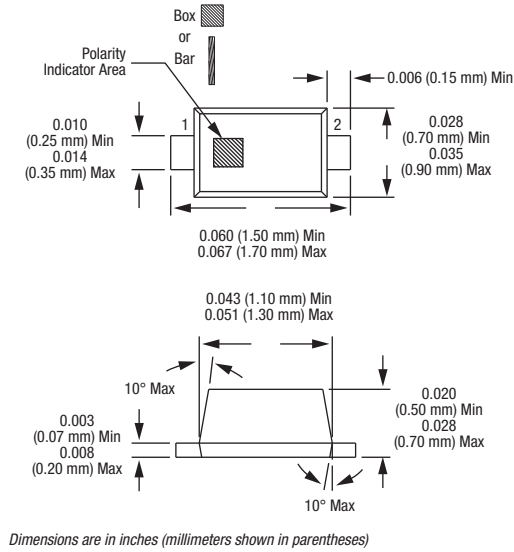
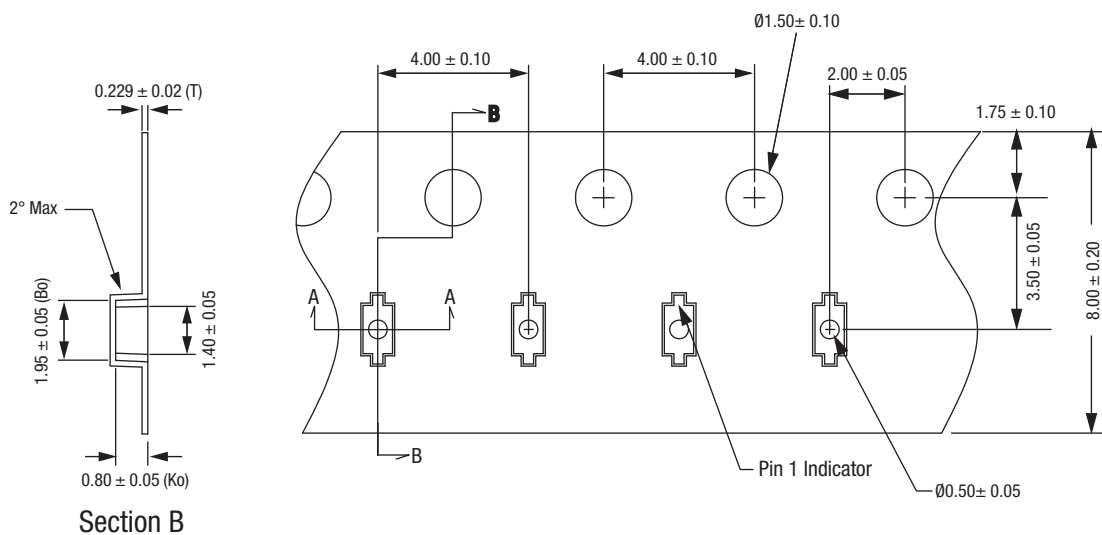
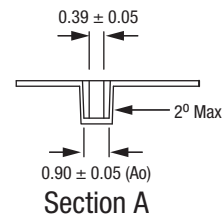

Figure 4. SC-79 Package Dimensions



Notes:

1. Carrier tape: black conductive polycarbonate or polystyrene.
2. Cover tape material: transparent conductive PSA.
3. Cover tape size: 5.4 mm width.
4. ESD-surface resistivity is $\leq 1 \times 10^8$ Ohms/square per EIA, JEDEC TNR Specification.
5. All measurements are in millimeters.



200076-005

Figure 5. SC-79 Tape and Reel Dimensions

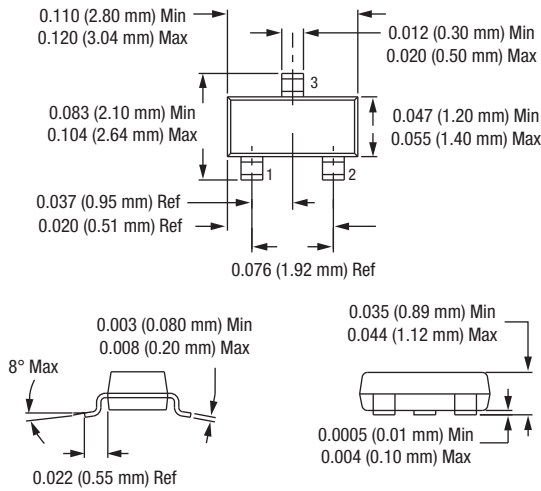

Dimensions are in inches (millimeters shown in parentheses)

200076-006

Figure 6. SOT-23 Package Dimensions

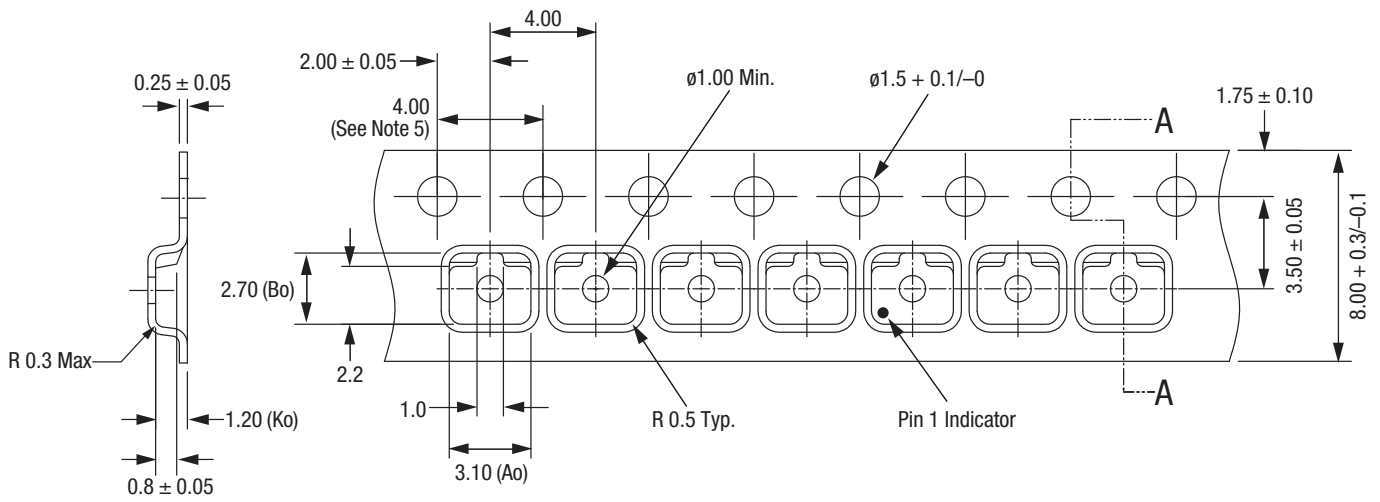

Section A

Notes:

1. Carrier tape: black conductive polycarbonate.
2. Cover tape material: transparent conductive PSA.
3. Cover tape size: 5.40 mm width.
4. Tolerance ±0.10 mm.
5. Ten sprocket hole pitch cumulative tolerance: ±0.2 mm.
6. All measurements are in millimeters.
7. Alternative carrier tape dimensions are:
 Ao = 3.3
 Bo = 2.9
 Ko = 1.22

200076-007

Figure 7. SOT-23 Tape and Reel Dimensions

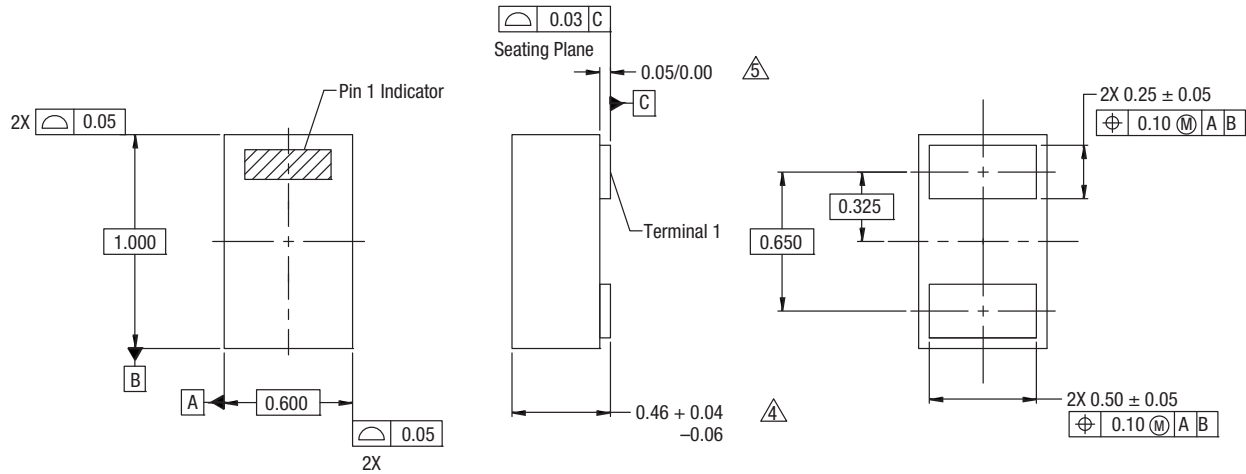

Notes:

1. All measurements are in millimeters.
2. Dimensions and tolerances according to ASME Y14.5M-1994.
3. These packages are used principally for discrete devices.
4. This dimension includes stand-off height and package body thickness, but does not include attached features, e.g., external heatsink or chip capacitors. An integral heatslug is not considered an attached feature.
5. This dimension is primarily terminal plating, but does not include small metal protrusion.

200076-008

Figure 8. SOD-882 Package Dimensions

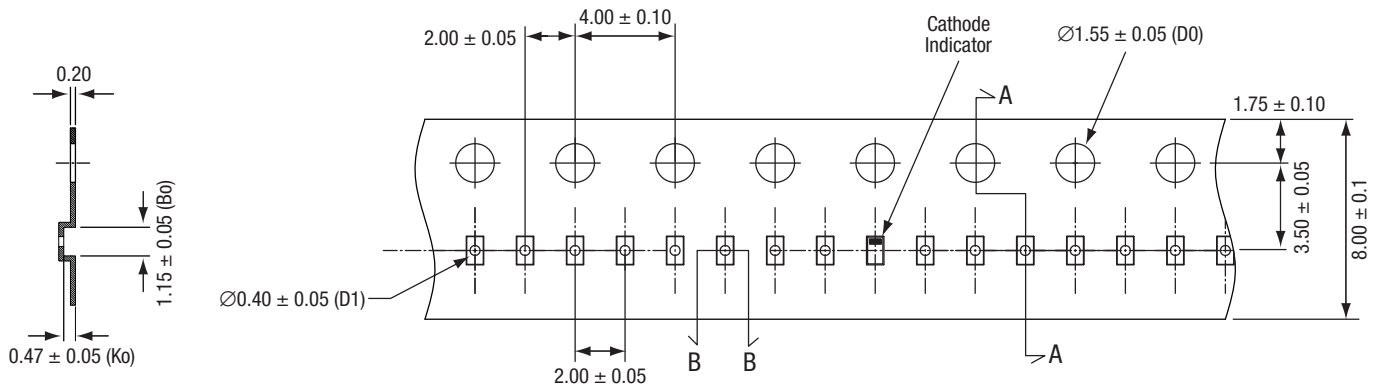

Section A

Notes:

1. Carrier tape: black conductive polycarbonate.
2. Cover tape: transparent conductive material.
3. Cover tape size: 5.4 mm width.
4. ESD surface resistivity is $\geq 1 \times 10^4 \sim \leq 1 \times 10^8$ Ohms/square.
5. All dimensions are in millimeters.

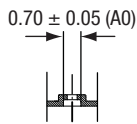

Section B

200076-009

Figure 9. SOD-882 Tape and Reel Dimensions

Copyright © 2002-2006, 2009- 2016 Skyworks Solutions, Inc. All Rights Reserved.

Information in this document is provided in connection with Skyworks Solutions, Inc. ("Skyworks") products or services. These materials, including the information contained herein, are provided by Skyworks as a service to its customers and may be used for informational purposes only by the customer. Skyworks assumes no responsibility for errors or omissions in these materials or the information contained herein. Skyworks may change its documentation, products, services, specifications or product descriptions at any time, without notice. Skyworks makes no commitment to update the materials or information and shall have no responsibility whatsoever for conflicts, incompatibilities, or other difficulties arising from any future changes.

No license, whether express, implied, by estoppel or otherwise, is granted to any intellectual property rights by this document. Skyworks assumes no liability for any materials, products or information provided hereunder, including the sale, distribution, reproduction or use of Skyworks products, information or materials, except as may be provided in Skyworks Terms and Conditions of Sale.

THE MATERIALS, PRODUCTS AND INFORMATION ARE PROVIDED "AS IS" WITHOUT WARRANTY OF ANY KIND, WHETHER EXPRESS, IMPLIED, STATUTORY, OR OTHERWISE, INCLUDING FITNESS FOR A PARTICULAR PURPOSE OR USE, MERCHANTABILITY, PERFORMANCE, QUALITY OR NON-INFRINGEMENT OF ANY INTELLECTUAL PROPERTY RIGHT; ALL SUCH WARRANTIES ARE HEREBY EXPRESSLY DISCLAIMED. SKYWORKS DOES NOT WARRANT THE ACCURACY OR COMPLETENESS OF THE INFORMATION, TEXT, GRAPHICS OR OTHER ITEMS CONTAINED WITHIN THESE MATERIALS. SKYWORKS SHALL NOT BE LIABLE FOR ANY DAMAGES, INCLUDING BUT NOT LIMITED TO ANY SPECIAL, INDIRECT, INCIDENTAL, STATUTORY, OR CONSEQUENTIAL DAMAGES, INCLUDING WITHOUT LIMITATION, LOST REVENUES OR LOST PROFITS THAT MAY RESULT FROM THE USE OF THE MATERIALS OR INFORMATION, WHETHER OR NOT THE RECIPIENT OF MATERIALS HAS BEEN ADVISED OF THE POSSIBILITY OF SUCH DAMAGE.

Skyworks products are not intended for use in medical, lifesaving or life-sustaining applications, or other equipment in which the failure of the Skyworks products could lead to personal injury, death, physical or environmental damage. Skyworks customers using or selling Skyworks products for use in such applications do so at their own risk and agree to fully indemnify Skyworks for any damages resulting from such improper use or sale.

Customers are responsible for their products and applications using Skyworks products, which may deviate from published specifications as a result of design defects, errors, or operation of products outside of published parameters or design specifications. Customers should include design and operating safeguards to minimize these and other risks. Skyworks assumes no liability for applications assistance, customer product design, or damage to any equipment resulting from the use of Skyworks products outside of stated published specifications or parameters.

Skyworks and the Skyworks symbol are trademarks or registered trademarks of Skyworks Solutions, Inc., in the United States and other countries. Third-party brands and names are for identification purposes only, and are the property of their respective owners. Additional information, including relevant terms and conditions, posted at www.skyworksinc.com, are incorporated by reference.



Компания «ЭлектроПласт» предлагает заключение долгосрочных отношений при поставках импортных электронных компонентов на взаимовыгодных условиях!

Наши преимущества:

- Оперативные поставки широкого спектра электронных компонентов отечественного и импортного производства напрямую от производителей и с крупнейших мировых складов;
- Поставка более 17-ти миллионов наименований электронных компонентов;
- Поставка сложных, дефицитных, либо снятых с производства позиций;
- Оперативные сроки поставки под заказ (от 5 рабочих дней);
- Экспресс доставка в любую точку России;
- Техническая поддержка проекта, помощь в подборе аналогов, поставка прототипов;
- Система менеджмента качества сертифицирована по Международному стандарту ISO 9001;
- Лицензия ФСБ на осуществление работ с использованием сведений, составляющих государственную тайну;
- Поставка специализированных компонентов (Xilinx, Altera, Analog Devices, Intersil, Interpoint, Microsemi, Aeroflex, Peregrine, Syfer, Eurofarad, Texas Instrument, Miteq, Cobham, E2V, MA-COM, Hittite, Mini-Circuits, General Dynamics и др.);

Помимо этого, одним из направлений компании «ЭлектроПласт» является направление «Источники питания». Мы предлагаем Вам помощь Конструкторского отдела:

- Подбор оптимального решения, техническое обоснование при выборе компонента;
- Подбор аналогов;
- Консультации по применению компонента;
- Поставка образцов и прототипов;
- Техническая поддержка проекта;
- Защита от снятия компонента с производства.



Как с нами связаться

Телефон: 8 (812) 309 58 32 (многоканальный)

Факс: 8 (812) 320-02-42

Электронная почта: org@eplast1.ru

Адрес: 198099, г. Санкт-Петербург, ул. Калинина, дом 2, корпус 4, литера А.