

# TM Series Miniature Snap-acting Switches



## Features/Benefits

- Broad range of operating forces available
- Wide variety of actuator and terminal styles
- Cost-effective solution

## Typical Applications

- Pumps and motors
- White goods
- Consumer appliances



## Specifications

**CONTACT RATING:** From low level\* to 15 AMPS @ 250 V AC.  
**ELECTRICAL LIFE:** 150,000 cycles at 15 AMPS @ 250 V AC, models with 150 grams operating force. 350,000 cycles at 10 AMPS @ 250 V AC, models with 75 grams operating force.  
**INSULATION RESISTANCE:** 1,000 M ohms min.  
**DIELECTRIC STRENGTH:** 1,000 Vrms min. @ sea level.  
**OPERATING TEMPERATURE:** -67°F to 302°F (-55°C to 150°C).  
**OPERATING FORCE:** 50, 75 and 150 grams at actuator available; refer to chart for lever style forces.  
**MOUNTING:** Torque screws 2-5 in/lbs.

\* Low Level=conditions where no arcing occurs during switching, i.e., 0.4 VA max. @ 20 V AC or DC max.

## Materials

**SWITCH HOUSING:** Thermoplastic or general purpose phenolic (UL 94V-0).  
**ACTUATOR BUTTON:** Thermoplastic (UL 94V-0).  
**SPRING:** Copper alloy.  
**PIVOT:** Brass alloy.  
**MOVABLE CONTACTS:** Gold alloy for ratings 1 AMP @ 125 V AC or less. Fine silver for ratings greater than 1 AMP @ 125 V AC.  
**STATIONARY CONTACTS:** Gold alloy for ratings 1 AMP or less. Fine silver for ratings greater than 1 AMP.  
**TERMINALS:** Brass alloy for ratings up to 10 AMPS @ 250 V AC. Copper alloy for 15 AMPS @ 250 V AC ratings.

**NOTE:** Specifications and materials listed above are for switches with standard options. For information on specific and custom switches, consult Customer Service Center.

## Build-A-Switch

To order, simply select desired option from each category and place in the appropriate box. Available options are shown and described on pages J-12 through J-16. For additional options not shown in catalog, consult Customer Service Center. Available extended electrical life per UL 1054, rated for 100,000 operations, consult factory.

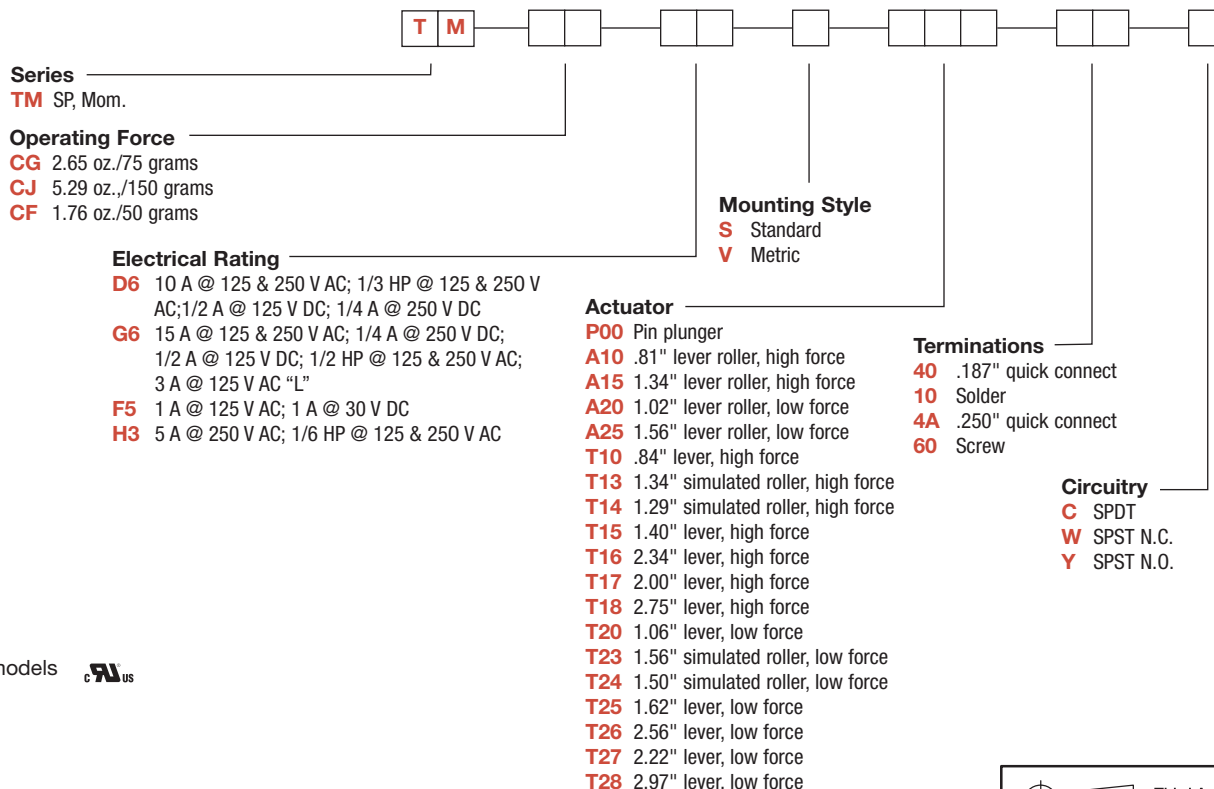

\* All models



Dimensions are shown: Inches (mm)  
 Specifications and dimensions subject to change

Snap-acting

# TM Series Miniature Snap-acting Switches

SERIES

**TM** MINIATURE SNAP-ACTING SWITCHES – SP MOMENTARY

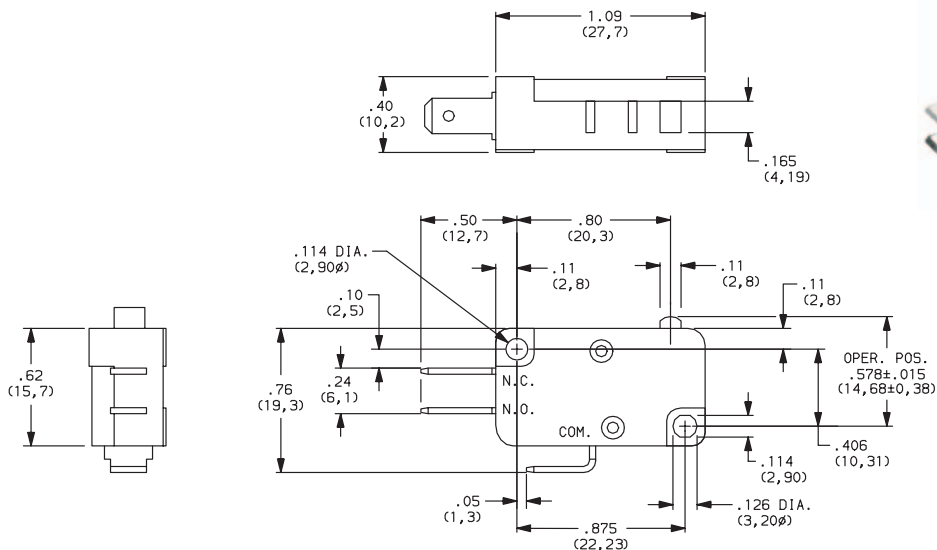

## OPERATING FORCE

OPTION CODE	BASIC SWITCH OPERATING FORCE (OZ./GRAMS)
<b>CG</b>	2.65 75
<b>CJ</b>	5.29 150
<b>CF</b>	1.76 50

Operating Force option 'CF' not available with 'T18, T27 and T28' actuator options. Operating force varies with actuator option, see ACTUATOR option section.

## ELECTRICAL RATING

OPTION CODE	RoHS COMPLIANT*	RoHS COMPATIBLE*	CONTACT MATERIAL		ELECTRICAL RATING
			MOVABLE CONTACT	STATIONARY CONTACT	
<b>D6</b>	Yes	Yes	Fine Silver	Fine Silver	10 AMPS @ 125 & 250 V AC; 1/3 HP @ 125 & 250 V AC; 1/2 AMP @ 125 V DC; 1/4 AMP @ 250 V DC.
<b>F5</b>	Yes	Yes	Gold alloy	Gold alloy	From low level* to 1 AMP @ 125 V AC, 1 AMP @ 30 V DC.
<b>G6</b>	Yes	Yes	Fine Silver	Fine Silver	15 AMPS @ 125 & 250 V AC; 0.25 AMP @ 250 V DC; 0.5 AMP @ 125 V DC; 1/2 HP @ 125 & 250 V AC; 3 AMPS @ 125 V AC "L".
<b>H3</b>	Yes	Yes			5 AMPS @ 250 V AC; 1/6 HP @ 125 & 250 V AC.

\* Note: See Technical Data section of this catalog for RoHS compliant and compatible definitions and specifications.

\* All models US

Contact Customer Service Center for availability and delivery of nonstandard ratings.

\* Low Level=conditions where no arcing occurs during switching, i.e., 0.4 VA max. @ 20 V AC or DC max.



Third Angle Projection

Dimensions are shown: Inch (mm)  
Specifications and dimensions subject to change



# TM Series Miniature Snap-acting Switches

## ELECTRICAL RATING

### AVAILABLE COMBINATIONS

ELECTRICAL RATING	MAXIMUM OPERATING FORCE (OZ./GRAMS)		
	1.76/50 CF	2.65/75 CG	5.29/150 CJ
D6	•	•	•
F5	•	•	•
G6	X	X	•
H3	•	•	•

• AVAILABLE  
X NOT AVAILABLE

\* All models 

Contact Customer Service Center for availability and delivery of nonstandard ratings.

\* Low Level=conditions where no arcing occurs during switching, i.e., 0.4 VA max. @ 20 V AC or DC max.

## MOUNTING STYLE

**S** Standard

**V** Metric

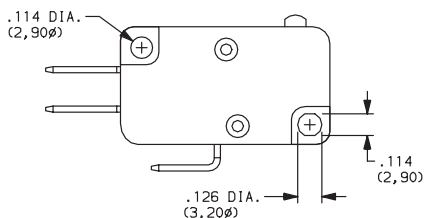

Recommended maximum screw size: 4-40.

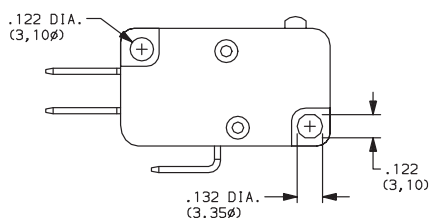

Recommended maximum screw size: 3 mm.

**NOTE:** Torque mounting screws 2-5 in/lbs.

Snap-acting



Dimensions are shown: Inches (mm)  
Specifications and dimensions subject to change

# TM Series Miniature Snap-acting Switches

## ACTUATOR

OPTION CODE	FIG.	DIM. A	DIM. B	DIM. C	DIM. D
<b>P00</b>	2	.80 (20,3)	—	.578 ± .015 (14,68 ± 0,38)	—
<b>A10</b>	1	.81 (20,6)	.36 (9,1)	.810 ± .020 (20,57 ± 0,51)	.19 dia. (4,80)
<b>A15</b>	1	1.34 (34,0)	.36 (9,1)	.810 ± .040 (20,57 ± 1,02)	.19 dia. (4,80)
<b>A20</b>	1	1.03 (26,2)	.58 (14,7)	.810 ± .050 (20,57 ± 1,27)	.19 dia. (4,80)
<b>A25</b>	1	1.56 (39,6)	.58 (14,7)	.810 ± .080 (20,57 ± 2,03)	.19 dia. (4,80)
<b>T10</b>	3	.84 (21,3)	.36 (9,1)	.600 ± .020 (15,24 ± 0,51)	—
<b>T13</b>	4	1.34 (34,0)	.36 (9,1)	.810 ± .040 (20,57 ± 1,02)	.19 dia. (4,80)
<b>T14</b>	4	1.28 (32,5)	.36 (9,1)	.743 ± .050 (18,9 ± 1,3)	.236 dia. (6,00)
<b>T15</b>	3	1.40 (35,6)	.36 (9,1)	.600 ± .040 (15,24 ± 1,02)	—
<b>T16</b>	3	2.34 (59,4)	.36 (9,1)	.600 ± .062 (15,24 ± 1,57)	—
<b>T17</b>	3	2.00 (50,8)	.36 (9,1)	.600 ± .052 (15,24 ± 1,57)	—
<b>T18</b>	3	2.75 (69,9)	.36 (9,1)	.600 ± .093 (15,24 ± 2,36)	—
<b>T20</b>	3	1.06 (26,9)	.58 (14,7)	.600 ± .045 (15,24 ± 1,14)	—
<b>T23</b>	4	1.56 (39,6)	.58 (14,7)	.810 ± .065 (20,57 ± 1,65)	.19 dia. (4,80)
<b>T24</b>	4	1.50 (38,1)	.58 (14,7)	.743 ± .090 (18,80 ± 2,29)	.236 dia. (6,00)
<b>T25</b>	3	1.62 (41,1)	.58 (14,7)	.600 ± .080 (15,24 ± 2,03)	—
<b>T26</b>	3	2.56 (65,0)	.56 (14,7)	.600 ± .125 (15,24 ± 3,18)	—
<b>T27</b>	3	2.22 (56,4)	.58 (14,7)	.600 ± .125 (15,24 ± 3,18)	—
<b>T28</b>	3	2.97 (75,4)	.58 (14,7)	.600 ± .187 (15,24 ± 4,75)	—

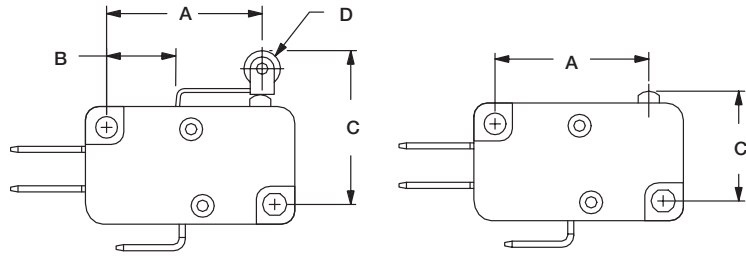

FIG. 1  
Lever Roller

FIG. 2  
Pin Roller

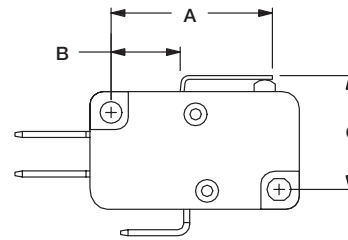

FIG. 3  
Lever

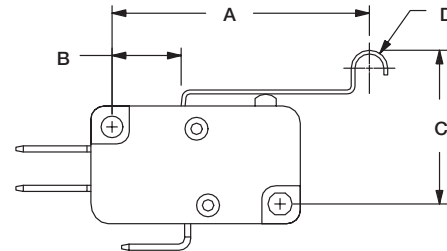
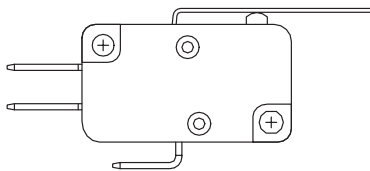

FIG. 4  
Simulated Roller

### HIGH FORCE, LOW MOTION PIVOT POSITION



Available with actuators A10, A15, T10, T13, T14, T15, T16, T17 and T18.

### LOW FORCE, HIGH MOTION PIVOT POSITION

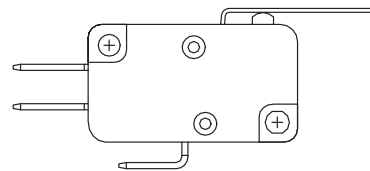

Available with actuators A20, A25, T20, T23, T24, T25, T26, T27 and T28.

**NOTE:** Lever actuator options are available in either of two pivot positions. Levers located in the forward pivot position have lower forces and higher motions. Levers located in the rear pivot position have higher forces and lower motions.



Dimensions are shown: Inch (mm)  
Specifications and dimensions subject to change



# TM Series Miniature Snap-acting Switches

**ACTUATOR**

## SWITCH CHARACTERISTICS

OPTION CODE	MAXIMUM OPERATING FORCE (OZ./GRAMS)			MINIMUM RELEASE FORCE (OZ./GRAMS)			MINIMUM RETURN FORCE (OZ./GRAMS)			MAXIMUM DIFFERENTIAL TRAVEL	MAXIMUM PRETRAVEL	MINIMUM OVERTRAVEL
	CF (50)	CG (75)	CJ (150)	CF (50)	CG (75)	CJ (150)	CF (50)	CG (75)	CJ (150)	ALL FORCES	ALL FORCES	ALL FORCES
T10	2.12 60	3.17 90	6.35 180	.49 14	.99 28	1.69 48	.25 7	.53 15	1.06 30	.013 (0,33)	.080 (2,03)	.035 (0,89)
T13	1.06 30	1.59 45	2.82 80	.21 6	.35 10	.71 20	.11 3	.14 4	.35 10	.030 (0,76)	.160 (4,06)	.065 (1,65)
T13	1.06 30	1.76 50	3.17 90	.25 7	.35 10	.71 20	.11 3	.14 4	.35 10	.050 (1,27)	.140 (3,56)	.062 (1,57)
T15	1.06 30	1.59 45	2.28 80	.21 6	.32 9	.71 20	.11 3	.14 4	.35 10	.032 (0,81)	.160 (4,06)	.075 (1,90)
T16	.53 15	.71 20	1.41 40	.11 3	.18 5	.35 10	.05 1.5	.07 2	.18 5	.090 (2,29)	.312 (7,92)	.140 (3,56)
T17	.71 20	.88 25	1.76 50	.14 4	.21 6	.42 12	.07 2	.07 2	.21 6	.062 (1,57)	.220 (5,59)	.110 (2,79)
T18	N/A	.71 20	1.23 35	N/A	.14 4	.28 8	N/A	.04 1	.14 4	.078 (1,98)	.375 (9,52)	.160 (4,06)
T20	1.06 30	1.59 45	3.17 90	.21 6	.32 9	.71 20	.11 3	.18 5	.35 10	.030 (0,76)	.160 (4,06)	.065 (1,65)
T23	.53 15	1.06 30	1.59 45	.11 3	.18 5	.35 10	.04 1	.07 2	.18 5	.070 (1,78)	.312 (7,92)	.125 (3,18)
T24	.53 15	1.23 35	1.76 50	.11 3	.18 5	.35 10	.05 1.5	.07 2	.18 5	.080 (2,03)	.312 (7,92)	.110 (2,79)
T25	.71 20	1.06 30	1.41 40	.07 2	.14 4	.32 9	.04 1	.07 2	.16 4.5	.070 (1,78)	.330 (8,38)	.100 (2,54)
T26	N/A	.35 10	.71 20	N/A	.07 2	.18 5	N/A	.04 1	.07 2	.110 (2,79)	.500 (12,7)	.250 (6,35)
T27	N/A	.60 17	.88 25	N/A	.11 3	.21 6	N/A	.04 1	.11 3	.125 (3,18)	.500 (12,70)	.200 (5,08)
T28	N/A	.42 12	.63 18	N/A	.07 2	.14 4	N/A	.04 1	.07 2	.187 (4,75)	.750 (19,05)	.280 (7,11)
A10	2.12 60	3.17 90	6.35 180	.49 14	.99 28	1.69 48	.25 7	.53 15	1.06 30	.013 (0,33)	.070 (1,78)	.035 (0,89)
A15	1.06 30	1.59 45	2.82 80	.21 6	.35 10	.71 20	.11 3	.14 4	.35 10	.030 (0,76)	.160 (4,06)	.065 (1,65)
A20	1.06 30	1.76 50	3.17 90	.25 7	.35 10	.71 20	.11 3	.18 5	.35 10	.025 (0,64)	.140 (3,56)	.060 (1,52)
A25	.53 15	1.06 30	1.59 45	.11 3	.18 5	.35 10	.04 1	.07 2	.18 5	.070 (1,78)	.312 (7,92)	.125 (3,18)
P00	1.76 50	2.65 75	5.29 150	.71 20	.99 28	2.12 60	.35 10	.53 15	1.06 30	.013 (0,33)	.056 (1,42)	.035 (0,89)

**NOTE:** For basic switch operating forces, see page J-12.



**Snap-acting**

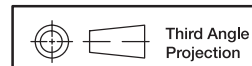

Dimensions are shown: Inches (mm)  
Specifications and dimensions subject to change

# TM Series Miniature Snap-acting Switches

## TERMINATIONS

### 40 .187" QUICK CONNECT

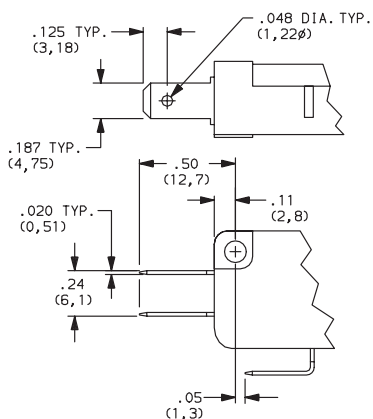

### 60 SCREW TERMINALS

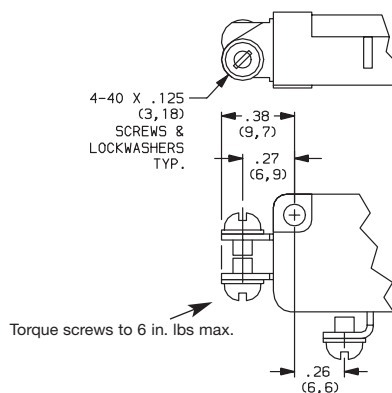

Not available with 'F5' rating option.

### 10 SOLDER

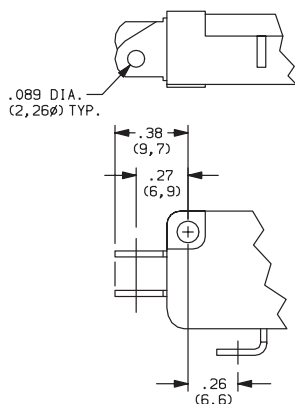

Not available with 'F5' rating option.

### 4A .250" QUICK CONNECT

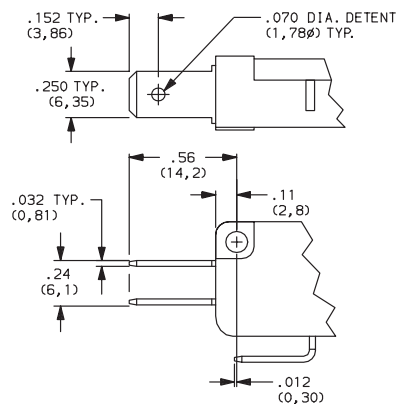

Not available with 'F5' rating option.

## CIRCUITRY

- C** SPDT (Single Pole, Double Throw)
- W** SPST N.C. (Single Pole, Single Throw, Normally Closed)
- Y** SPST N.O. (Single Pole, Single Throw, Normally Open)



Third Angle  
Projection

Dimensions are shown: Inch (mm)

Specifications and dimensions subject to change



Компания «ЭлектроПласт» предлагает заключение долгосрочных отношений при поставках импортных электронных компонентов на взаимовыгодных условиях!

Наши преимущества:

- Оперативные поставки широкого спектра электронных компонентов отечественного и импортного производства напрямую от производителей и с крупнейших мировых складов;
- Поставка более 17-ти миллионов наименований электронных компонентов;
- Поставка сложных, дефицитных, либо снятых с производства позиций;
- Оперативные сроки поставки под заказ (от 5 рабочих дней);
- Экспресс доставка в любую точку России;
- Техническая поддержка проекта, помощь в подборе аналогов, поставка прототипов;
- Система менеджмента качества сертифицирована по Международному стандарту ISO 9001;
- Лицензия ФСБ на осуществление работ с использованием сведений, составляющих государственную тайну;
- Поставка специализированных компонентов (Xilinx, Altera, Analog Devices, Intersil, Interpoint, Microsemi, Aeroflex, Peregrine, Syfer, Eurofarad, Texas Instrument, Miteq, Cobham, E2V, MA-COM, Hittite, Mini-Circuits, General Dynamics и др.);

Помимо этого, одним из направлений компании «ЭлектроПласт» является направление «Источники питания». Мы предлагаем Вам помощь Конструкторского отдела:

- Подбор оптимального решения, техническое обоснование при выборе компонента;
- Подбор аналогов;
- Консультации по применению компонента;
- Поставка образцов и прототипов;
- Техническая поддержка проекта;
- Защита от снятия компонента с производства.



#### Как с нами связаться

**Телефон:** 8 (812) 309 58 32 (многоканальный)

**Факс:** 8 (812) 320-02-42

**Электронная почта:** [org@eplast1.ru](mailto:org@eplast1.ru)

**Адрес:** 198099, г. Санкт-Петербург, ул. Калинина, дом 2, корпус 4, литера А.