

GENERAL SPECIFICATIONS

Electrical Capacity

Resistive Load: 15A & ½ HP @ 125 or 250V AC for high capacity models
Lamp Load: 5A @ 125V AC

Other Ratings

Contact Resistance: 15 milliohms maximum
Insulation Resistance: 100 megohms minimum @ 500V DC
Dielectric Strength: 1,000V AC minimum between contacts for 1 minute minimum;
 1,500V AC minimum between contacts & case for 1 minute minimum
Mechanical Life: 1,000,000 operations minimum
Electrical Life: 50,000 operations minimum
Travel: Pretravel .047" (1.19mm); Overtravel .040" (1.01mm); Differential .011" (0.27mm)
Operating Temp Range: -40°C through +85°C (-40°F through +185°F)

Materials & Finishes

Caps & Shrouds: Polycarbonate with glossy finish or PBT
Plunger: Polyacetal or brass with nickel plating
Bushing: Steel with zinc plating or glass fiber reinforced polyamide
Case: Polyester
Movable & Stationary Contacts: Silver alloy
Terminals: Brass with silver plating

Standards & Certifications

UL: Internal snap switch is UL recognized.
CSA: Internal snap switch is CSA certified.

TYPICAL SWITCH ORDERING EXAMPLE

SCB

2

5

P

15

A

—

4

CA

Poles

1	SPDT
2	DPDT

Circuits

5	ON	(ON)
6	ON	ON

() = Momentary

Bushings

P	Plastic (with momentary only)
S	Steel

Rating

15	15A
----	-----

Terminals

A	.187" (4.75mm) Quick Connect
* B	.250" (6.35mm) Quick Connect

Note: Contact factory for availability of screw lug and solder lug models.

* Available in Americas only

Caps & Shrouds

For Momentary

3	.520" (13.2mm) Diameter Cap
---	-----------------------------

For Momentary & Alternate Action

4	Round Cap & Shroud (AT454 & AT455)
5	Rectangular Cap & Shroud (AT452 & AT453)

DESCRIPTION FOR TYPICAL ORDERING EXAMPLE

SCB25P15A-4CA

DPDT ON-(ON) Circuit

15A Rating

Round Red Cap with Black Shroud

Plastic Bushing

.187" (4.75mm) Quick Connect Terminals

Colors

Caps		Shrouds
A	Black	A
B	White	B
C	Red	—
F	Green	—
G	Blue	—
H	Gray	H

Note: Standard hardware is provided with caps. See Bushing detail for more information.

Toggles

Rockers

Pushbuttons

Illuminated PB

Keylocks

Rotaries

Slides

Tactiles

Tilt





Touch

Indicators

Accessories

Supplement

POLES & CIRCUITS

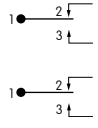
		Plunger Position () = Momentary		Connected Terminals		Throw & Schematics
Pole	Model	Normal  Keyway	Down 	Normal  Keyway	Down 	Note: Terminal numbers are actually on the switch.
SP	SCB15 SCB16	ON ON	(ON) ON	1-2	1-3	SPDT 
DP	SCB25 SCB26	ON ON	(ON) ON	1-2 1-2	1-3 1-3	SP with 2 switches 

BUSHINGS

P Plastic
(for Momentary only)

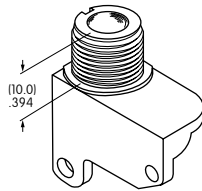

S Steel

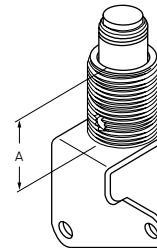

"A" =
11.2mm
Momentary
15.5mm
Alternate Action

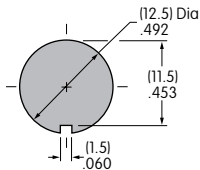

Maximum Effective Panel Thickness:
.165" (4.2mm) without Shroud
.157" (4.0mm) with Shroud

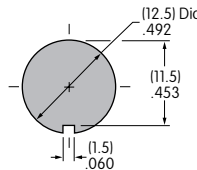

Maximum Effective Panel Thickness:
Momentary: .177" (4.5mm) without Shroud
.157" (4.0mm) with Shroud
Alternate Action: .354" (9.0mm)

Standard Hardware Provided with Caps

Cap Option 3: AT504M Knurled Face Nut, AT508 Lockwasher, AT527M Hex Mounting Nut

Cap Options 4 & 5: AT508 Lockwasher & AT527M Hex Mounting Nut

TERMINALS

A .187" (4.75mm)
Quick Connect

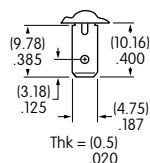

B .250" (6.35mm)
Quick Connect

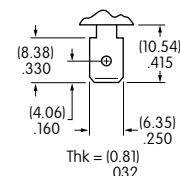

TYPICAL SWITCH DIMENSIONS

.520" (13.2mm) Dia. Cap • .187" (4.75mm) Quick Connect

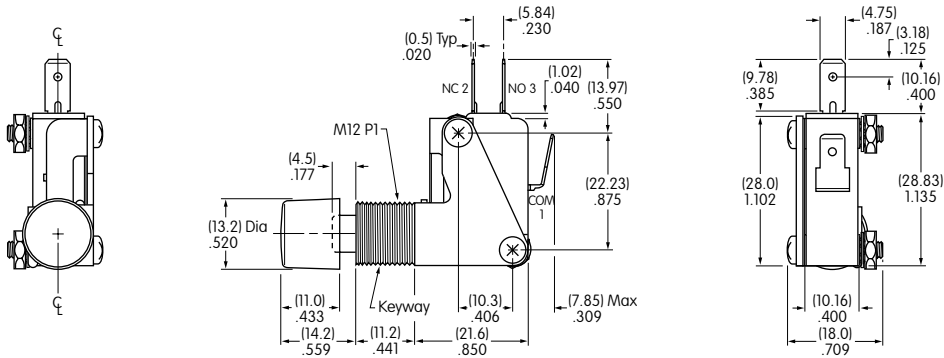

SCB15S15A-3C

Round Cap & Shroud • .187" (4.75mm) Quick Connect

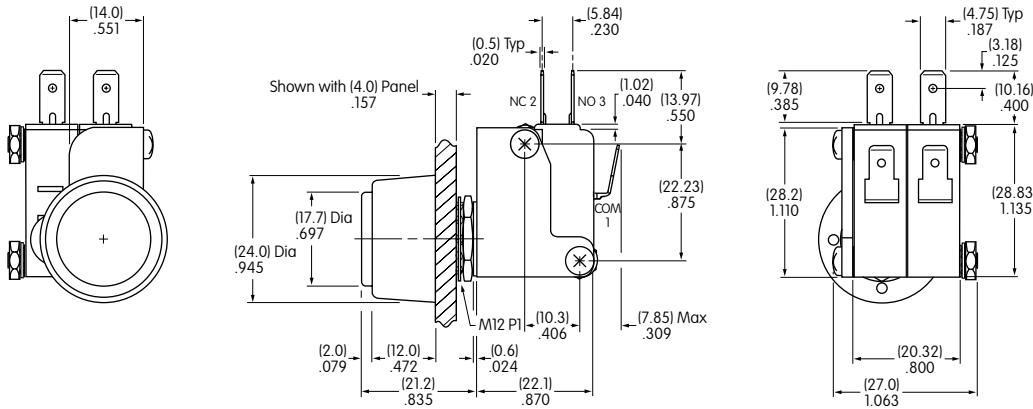

SCB25P15A-4CA

Rectangular Cap & Shroud • .250" (6.35mm) Quick Connect

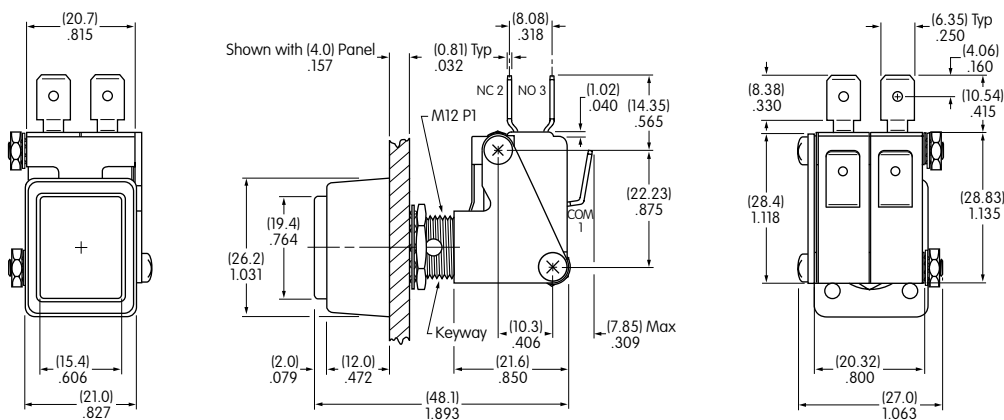

SCB26S15B-5CA



Компания «ЭлектроПласт» предлагает заключение долгосрочных отношений при поставках импортных электронных компонентов на взаимовыгодных условиях!

Наши преимущества:

- Оперативные поставки широкого спектра электронных компонентов отечественного и импортного производства напрямую от производителей и с крупнейших мировых складов;
- Поставка более 17-ти миллионов наименований электронных компонентов;
- Поставка сложных, дефицитных, либо снятых с производства позиций;
- Оперативные сроки поставки под заказ (от 5 рабочих дней);
- Экспресс доставка в любую точку России;
- Техническая поддержка проекта, помощь в подборе аналогов, поставка прототипов;
- Система менеджмента качества сертифицирована по Международному стандарту ISO 9001;
- Лицензия ФСБ на осуществление работ с использованием сведений, составляющих государственную тайну;
- Поставка специализированных компонентов (Xilinx, Altera, Analog Devices, Intersil, Interpoint, Microsemi, Aeroflex, Peregrine, Syfer, Eurofarad, Texas Instrument, Miteq, Cobham, E2V, MA-COM, Hittite, Mini-Circuits, General Dynamics и др.);

Помимо этого, одним из направлений компании «ЭлектроПласт» является направление «Источники питания». Мы предлагаем Вам помощь Конструкторского отдела:

- Подбор оптимального решения, техническое обоснование при выборе компонента;
- Подбор аналогов;
- Консультации по применению компонента;
- Поставка образцов и прототипов;
- Техническая поддержка проекта;
- Защита от снятия компонента с производства.



Как с нами связаться

Телефон: 8 (812) 309 58 32 (многоканальный)

Факс: 8 (812) 320-02-42

Электронная почта: org@eplast1.ru

Адрес: 198099, г. Санкт-Петербург, ул. Калинина, дом 2, корпус 4, литера А.